

EMB-BSW1

Industrial Motherboard

Copyright Notice

This document is copyrighted, 2019. All rights are reserved. The original manufacturer reserves the right to make improvements to the products described in this manual at any time without notice.

No part of this manual may be reproduced, copied, translated, or transmitted in any form or by any means without the prior written permission of the original manufacturer. Information provided in this manual is intended to be accurate and reliable. However, the original manufacturer assumes no responsibility for its use, or for any infringements upon the rights of third parties that may result from its use. The material in this document is for product information only and is subject to change without notice. While reasonable efforts have been made in the preparation of this document to assure its accuracy, the original manufacturer assumes no liabilities resulting from errors or omissions in this document, or from the use of the information contained herein.

The original manufacturer reserves the right to make changes in the product design without notice to its users.

Acknowledgments

All other products' name or trademarks are properties of their respective owners.

- AMI is a trademark of American Megatrends Inc.
- Intel®, Core™ are trademarks of Intel® Corporation.
- Microsoft Windows® is a registered trademark of Microsoft Corp.
- ITE is a trademark of Integrated Technology Express, Inc.
- IBM, PC/AT, PS/2, and VGA are trademarks of International Business Machines Corporation.

The original manufacturer reserves the right to make changes in the product design without notice to its users.

All other product names or trademarks are properties of their respective owners.

Contents

Chapter 1: Product overview

1.1	Package contents.....	1-1
1.2	Features	1-1
1.3	Specifications.....	1-2

Chapter 2: Motherboard information

2.1	Before you proceed	2-1
2.2	Motherboard layout.....	2-2
2.3	Screw size.....	2-4
2.3.1	Component side	2-4
2.3.2	Solder side	2-5
2.4	Central Processing Unit (CPU)	2-6
2.5	System memory	2-6
2.6	Jumpers	2-7
2.7	Connectors	2-10
2.7.1	Rear panel connectors.....	2-10
2.7.2	Internal connectors	2-11

Chapter 3: BIOS setup

3.1	BIOS setup.....	3-1
3.2	Main menu	3-2
3.2.1	System Date [Day MM/DD/YYYY]	3-2
3.2.2	System Time [HH:MM:SS]	3-2
3.3	Advanced menu	3-2
3.3.1	CPU Configuration	3-2
3.3.2	SATA Configuration	3-3
3.3.3	USB Configuration	3-3
3.3.4	Hardware Monitor	3-3
3.3.5	Trusted Computing	3-4
3.3.6	SIO Configuration	3-4
3.3.7	Power Management.....	3-5
3.3.8	Digital IO Port Configuration	3-5
3.4	Chipset menu	3-6
3.4.1	North Bridge.....	3-6
3.4.2	South Bridge	3-6

Contents

- 3.5 Security menu 3-6**
 - 3.5.1 Administrator Password 3-6
 - 3.5.2 User Password 3-7
- 3.6 Boot menu 3-7**
 - 3.6.1 Boot Configuration 3-7
 - 3.6.2 Boot Option Priorities 3-8
- 3.7 Save & Exit menu 3-8**

- Appendix**
- Notices A-1**

Chapter 1

Product overview

1.1 Package contents

Check your industrial motherboard package for the following items.

- 1 x Industrial Motherboard
- 1 x SATA cable
- 1 x SATA power cable
- 1 x I/O shield
- 1 x Support DVD



NOTE: If any of the above items are damaged or missing, contact your distributor or sales representative immediately.

1.2 Features

- Integrated Intel® Atom™ Processor N3710/N3060
- Two Dual Channel DDR3L 1600MHz SO-DIMM up to 8GB
- Realtek® ALC3236 6-Channel High Definition Audio CODEC
- Multi Display: HDMI + HDMI + LVDS, HDMI + HDMI + eDP
- Dual Ethernet LAN: Intel® i211AT x 2
- SATA 6Gb/s x 3, USB2.0 x 6, USB3.0 x 4, COM x 6
- 1 x Half-height Mini Card Slot with PCIe and USB Interface, 1 x Full-height Mini Card Slot with mSATA Interface

1.3 Specifications

SYSTEM	
CPU	N3710, Braswell-M/D (4C @ 2.56GHz CPU [Burst Mode], 700MHz GFX (Turbo), ~6W TDP) N3060, Braswell-M/D (2C @ 2.48GHz CPU [Burst Mode], 600MHz GFX (Turbo), ~6W TDP)
Memory	2 x SO-DIMM, max. 8GB, DDR3L 1600MHz, non-ECC, un-buffered memory, horizontal type Dual channel memory architecture
I/O Chipset	F81866D
LAN	1 x Intel® i211AT 1 x Intel® i211AT via AsMedia 1184e
Audio	Realtek® ALC3236
TPM	Infineon SLB96xx TT 1.2/2.0 onboard (Default: No)
Expansion slots	1 x Half-size Mini Card (PCIe +USB) 1 x Full-size Mini Card (mSATA) via AsMedia 1184e at least 60mm length (PCIe + USB optional)
BIOS	64Mb Flash ROM, AMI BIOS
H/W Status Monitor	Monitors CPU/system temperature Monitors Vcore, 3.3V/5V/12V voltages Monitors chassis fan speed
Watchdog Timer	1~255 steps by software program
Smart Fan Control	Chassis fan (fanless)
Wake On LAN / PXE	Yes (WOL, PXE)
Power States	S3, S4, S5
Graphics	
Graphics Chipset	Intel® HD Graphics
Graphics Multi Display	HDMI + HDMI + LVDS (Default) HDMI + HDMI + eDP (BOM change)
HDMI Resolution	Up to 2560 x 1600 @60 Hz, 3840 x 2160 @30Hz
LVDS / eDP	Up to 1920 x 1080 @60Hz, Daul Channel 18/24 bit (via CH7511) eDP up to 2560 x 1440 @60Hz
Backlight Control	Voltage / PWM, use HW control
Environment, Power, and ME	
Battery	Lithium battery
Power requirement	12-24V DC (wide range: 12V-5% - 24V+10%)
Operating temperature	32°F~131°F (0°C~55°C)
Operating humidity	0%~90% relative humidity, non-condensing
Certificate	CE, FCC (Class A)
Form factor	Mini-ITX form factor: 6.7 in. x 6.7 in. (17.0 cm x 17.0 cm)
Weight	1.1 lb (0.5 Kg)

(continued on the next page)

I/O	
Storage	3 x SATA 6Gb/s 1 x SATA power connector (5V / 12V @ 1A)
USB	2 x USB 3.0 ports (at back panel) 2 x USB 3.0 ports (internal box header) 4 x USB 2.0 ports (2 ports for header, 2 ports for minicard) 4 x USB 2.0 ports via ASIX MCS9990 (internal box header) (Default: No)
Display I/O	1 x LVDS (eDP optional by BOM change), 2 x HDMI
Audio I/O	Mic-In, Line-Out, internal speaker
LAN I/O	2 x RJ-45 ports on rear I/O
Serial ports	5 x RS-232 1 x RS-232/422/485 supports 5V/12V/RI option (COM1)
PS/2 keyboard/ mouse port	Yes (WOL / PXE)
DIO	8-bit Digital I/O interface (4-in / 4-out)
Fan	1 x Chassis fan connector (4-pin)
I/O Placement	
Back panel I/O ports (Low profile)	1 x DC port (12V~24V, screw type) 2 x USB 3.0 ports 2 x LAN (RJ-45) ports 2 x HDMI ports 1 x Audio jack (Line-Out), green 1 x Audio jack (Mic-in), pink
Internal I/O connectors	1 x Mini Card slot (half-size Height=4mm) 1 x Mini Card slot (full-size Height=9.9mm) 1 x P/S2 header 3 x SATA 6.0 connectors 1 x SATA power connector 1 x USB 3.0 headers support additional 2 USB ports (2 x 10PIN, p=2.00mm) 3 x USB 2.0 headers support additional 6 USB ports (2 x 5PIN, p=2.00mm), (Default:1 header onboard) 1 x Chassis fan connector 5 x boxer headers for COM (RS-232) 1 x boxer header for COM (RS-232 / 422 / 485) 1 x Digital I/O connector (4-in / 4-out) 1 x 40-pin LVDS / eDP connector (colay) 1 x LVDS 3V / 5V jumper 1 x LCD DC / PWM mode jumper 1 x LCD backlight connector (inverter) 1 x LCD backlight 12V / 5V jumper 1 x Battery horizontal socket 2 x Internal speaker (2W) 1 x 2*2 PIN DCIN 12V AUX power connector 1 x System panel connector 1 x AT/ATX mode select jumper (optional) 1 x CMOS jumper 1 x COM1 Ring/+5V/+12V selection jumper 1 x Chassis intrusion jumper 1 x Embedded DisplayPort (eDP) 1 x SPI flash programmable connector

(continued on the next page)

Others	
Supported OS	Windows® 7 32-bit Windows® 8.1 32-bit / 64-bit Windows® 10 64-bit Linux Fedora
Accessories	1 x SATA cable 1 x SATA power cable 1 x I/O shield 1 x Support DVD



NOTE: Specifications are subject to change without notice.

Chapter 2

Motherboard information

2.1 Before you proceed

Take note of the following precautions before you install motherboard components or change any motherboard settings.



CAUTION!

- Unplug the power cord from the wall socket before touching any component.
- Before handling components, use a grounded wrist strap or touch a safely grounded object or a metal object, such as the power supply case, to avoid damaging them due to static electricity.
- Hold components by the edges to avoid touching the ICs on them.
- Whenever you uninstall any component, place it on a grounded antistatic pad or in the bag that came with the component.
- Before you install or remove any component, ensure that the power supply is switched off or the power cord is detached from the power supply. Failure to do so may cause severe damage to the motherboard, peripherals, or components.

Main and Standby Power LEDs

The motherboard comes with one standby power LED and main power LED that light up to indicate that the system is ON, in sleep mode, or in soft-off mode. This is a reminder that you should shut down the system and unplug the power cable before removing or plugging in any motherboard component. The illustration below shows the location of the onboard LEDs.

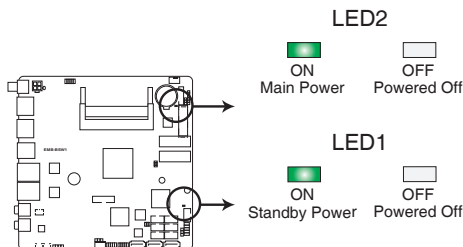

EMB-BSW1 Onboard LEDs

2.2 Motherboard layout



NOTE: Place four screws into the holes indicated by circles to secure the motherboard to the chassis.



CAUTION! Do not overtighten the screws! Doing so can damage the motherboard.

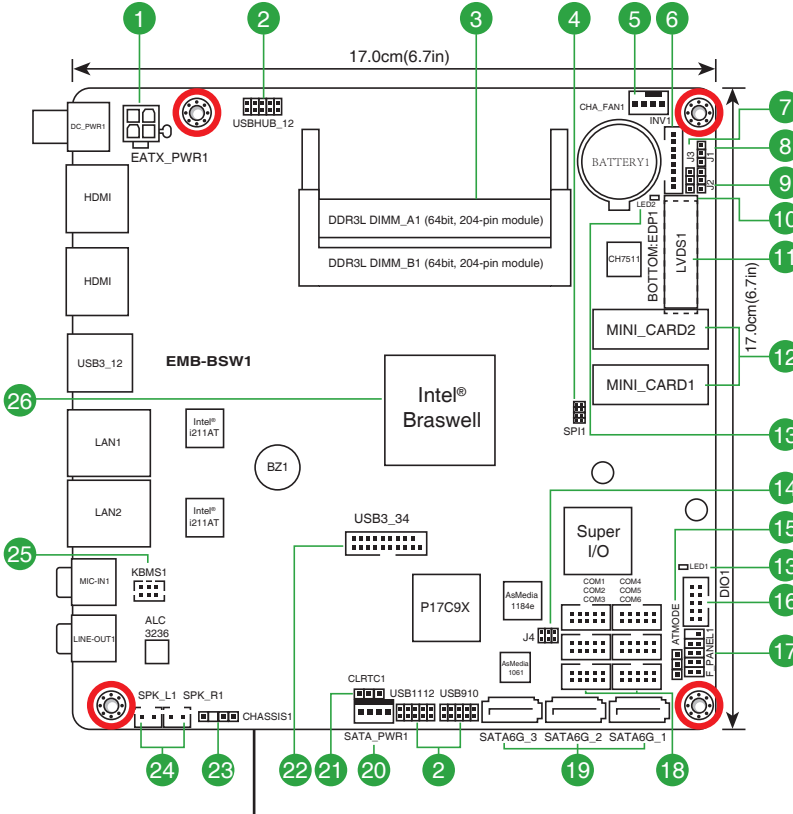

Place this side towards the rear of the chassis

Connectors/Jumpers/Slots/LEDs		Page
1.	EATX power connector (4-pin EATX_PWR1)	2-12
2.	USB 2.0 connectors (10-pin USBHUB_12, USB9~12)	2-13
3.	DDR3L DIMM slots	2-6
4.	SPI programming connector (8-pin SPI1)	2-15
5.	Chassis fan connector (4-pin CHA_FAN1)	2-11
6.	Backlight inverter power connector (5-pin INV1)	2-16
7.	Inverter backlight control mode selection (3-pin J3)	2-8
8.	LVDS panel voltage selection (3-pin J1)	2-7
9.	Inverter voltage selection (3-pin J2)	2-8
10.	LVDS connector (40-pin LVDS1)	2-14
11.	Embedded display port (40-pin EDP1)	2-11
12.	Mini Card slots (MINICARD1, MINICARD2)	2-15
13.	Main and standby power LEDs (LED1, LED2)	2-1
14.	COM1 Ring/+5V/+12V selection jumper (6-pin J4)	2-8
15.	AT Mode selection (3-pin ATMODE)	2-9
16.	Digital I/O connector (10-pin DIO1)	2-16
17.	System panel connector (10-1 pin F_PANEL1)	2-12
18.	Serial port connectors (9-pin COM1~6)	2-17
19.	Serial ATA 6.0Gb/s connectors (7-pin SATA6G_1~3)	2-13
20.	SATA power connector (4-pin SATA_PWR1)	2-16
21.	Clear RTC RAM (3-pin CLRTC1)	2-7
22.	USB 3.0 connector (20-1 pin USB3_34)	2-14
23.	Chassis intrusion jumper (4-1 pin CHASSIS1)	2-9
24.	Internal audio connectors (2-pin SPK_L1, SPK_R1)	2-18
25.	PS/2 keyboard/mouse connector (6-pin KBMS1)	2-15
26.	Integrated Intel® Braswell processor N3710/N3060	2-6

2.3 Screw size

2.3.1 Component side

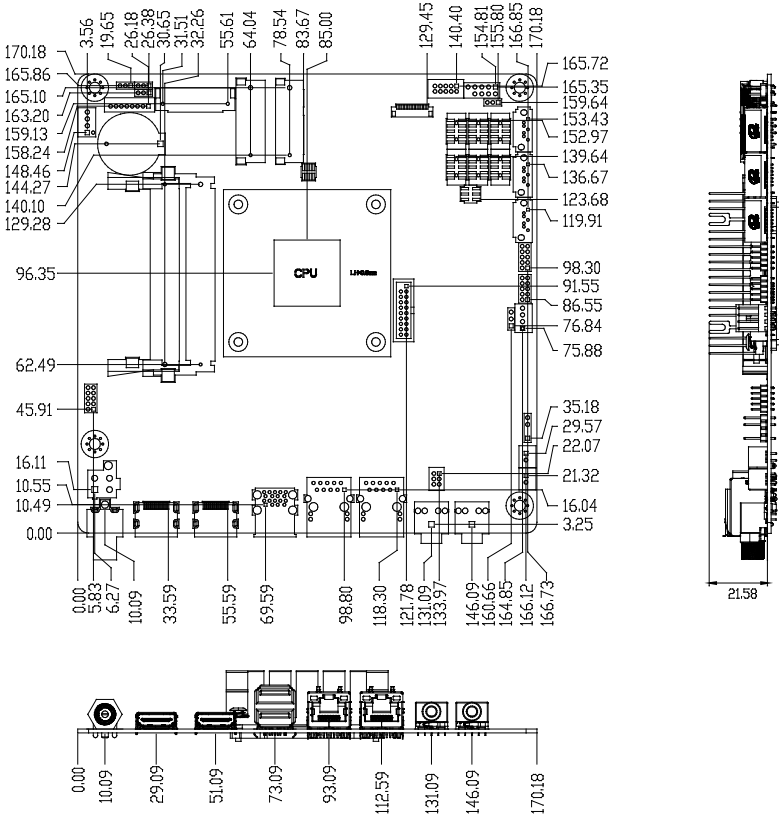

2.3.2 Solder side

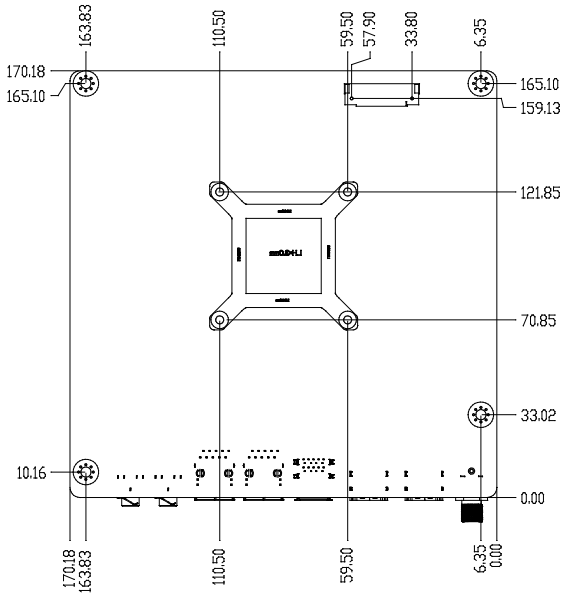

2.4 Central Processing Unit (CPU)

The motherboard comes with an integrated Intel® Braswell processor N3710/ N3060.

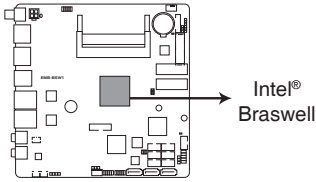

EMB-BSW1 onboard CPU

2.5 System memory

This motherboard comes with two Double Data Rate 3 Low Voltage (DDR3L) Small Outline Dual Inline Memory Modules (SO-DIMM) sockets. The figure illustrates the location of the DDR3L DIMM sockets:

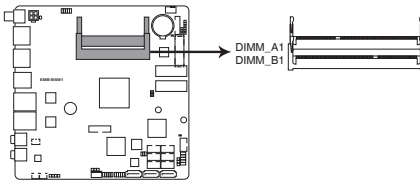

EMB-BSW1 204-pin DDR3L SO-DIMM sockets



NOTE: Use the SO-DIMM_A1 slot when inserting only one SO-DIMM.

Installing a DIMM

To install a DIMM

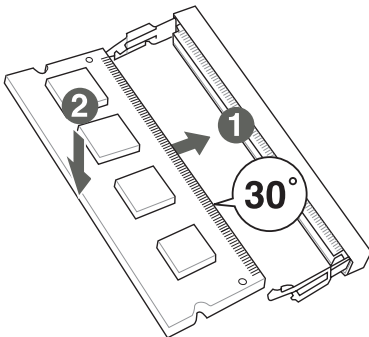

To remove a DIMM

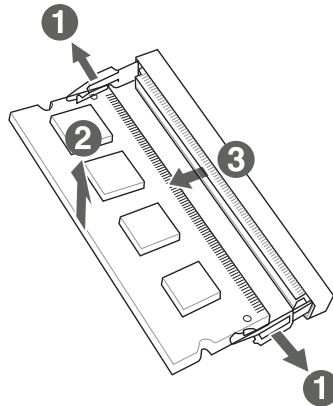

2.6 Jumpers

1. Clear RTC RAM (3-pin CLRTC1)

This jumper allows you to clear the Real Time Clock (RTC) RAM in CMOS. You can clear the CMOS memory of date, time, and system setup parameters by erasing the CMOS RTC RAM data. The onboard button cell battery powers the RAM data in CMOS, which include system setup information such as system passwords.

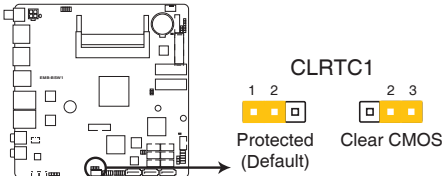

EMB-BSW1 Clear RTC RAM

To erase the RTC RAM:

1. Turn OFF the computer and unplug the power cord.
2. Move the jumper cap from pins 1-2 (default) to pins 2-3. Keep the cap on pins 2-3 for about 5~10 seconds, then move the cap back to pins 1-2.
3. Plug the power cord and turn ON the computer.
4. Hold down the key during the boot process and enter BIOS setup to reenter data.



CAUTION! Except when clearing the RTC RAM, never remove the cap on CLRTC jumper default position. Removing the cap will cause system boot failure!



NOTE: If the steps above do not help, remove the onboard battery and move the jumper again to clear the CMOS RTC RAM data. After clearing the CMOS, reinstall the battery.

2. LVDS panel voltage selection (3-pin J1)

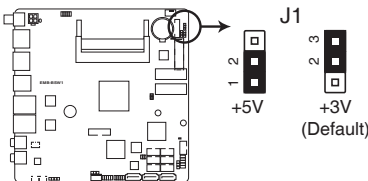

EMB-BSW1 LVDS Panel Voltage Selection

	Pins
+5V	1-2
+3V (Default)	2-3

3. Inverter voltage selection (3-pin J2)

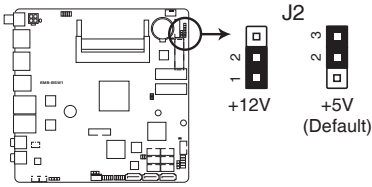

EMB-BSW1 Inverter Voltage Selection

	Pins
+12V	1-2
+5V (Default)	2-3

4. Inverter backlight control mode selection (3-pin J3)

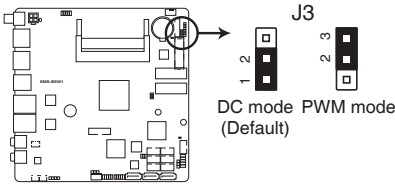

EMB-BSW1 Mode Selection for Back Light Control of Inverter

	Pins
DC mode (Default)	1-2
PWM mode	2-3

5. COM1 Ring/+5V/+12V selection (6-pin J4)

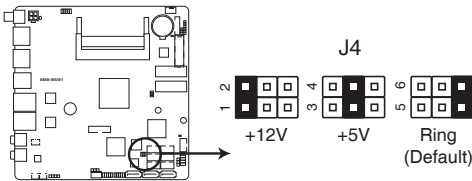

EMB-BSW1 COM1 Ring/+5V/+12V Selection

	Pins
+12V	1-2
+5V	3-4
Ring (Default)	5-6

6. AT mode selection (3-pin ATMODE)

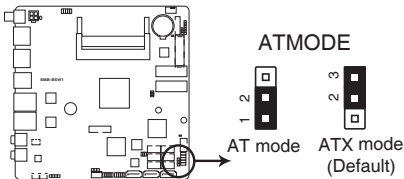

EMB-BSW1 ATMODE setting

	Pins
AT mode	1-2
ATX mode (Default)	2-3

7. Chassis intrusion jumper (4-1 pin CHASSIS1)

This connector is for a chassis-mounted intrusion detection sensor or switch. Connect one end of the chassis intrusion sensor or switch cable to this connector. The chassis intrusion sensor or switch sends a high-level signal to this connector when a chassis component is removed or replaced. The signal is then generated as a chassis intrusion event.

Move the jumper cap to pins 1-2 when you intend to use the chassis intrusion detection feature.

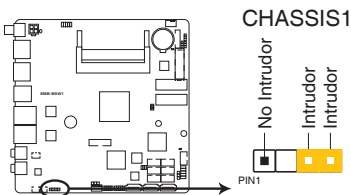

EMB-BSW1 Chassis intrusion connector

Pins	
1-2	Enables the chassis intrusion detection feature
3-4	Disables the chassis intrusion detection feature (Default)

2.7 Connectors

2.7.1 Rear panel connectors

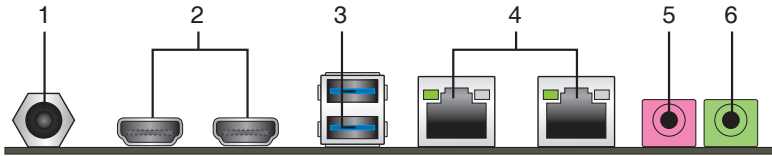

1. **DC power port.** This port connects to a DC power adapter.
2. **HDMI ports.** These ports are for a High-Definition Multimedia Interface (HDMI) connectors, and are HDCP compliant allowing playback of HD DVD, Blu-Ray, and other protected content.
3. **USB 3.0 ports.** These 9-pin Universal Serial Bus (USB) ports connect to USB 3.0/2.0 devices.



NOTES:

- DO NOT connect a keyboard / mouse to any USB 3.0 port when installing Windows® operating system.
- Due to USB 3.0 controller limitation, USB 3.0 devices can only be used under Windows® OS environment and after the USB 3.0 driver installation.
- We strongly recommend that you connect USB 3.0 devices to USB 3.0 ports for faster and better performance for your USB 3.0 devices.

4. **LAN (RJ-45) ports.** These ports allow Gigabit connection to a Local Area Network (LAN) through a network hub. Refer to the table below for the LAN port LED indications.

LAN port LED indications

ACT/LINK LED		SPEED LED	
Status	Description	Status	Description
OFF	No link	OFF	10 Mbps connection
GREEN	Linked	ORANGE	100 Mbps connection
BLINKING	Data activity	GREEN	1 Gbps connection

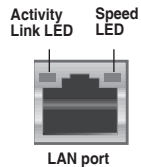

5. **Microphone port (pink).** This port connects to a microphone.
6. **Line Out port (lime).** This port connects to a headphone or a speaker. In the 4-channel and 6-channel configurations, the function of this port becomes Front Speaker Out.

2.7.2 Internal connectors

1. Chassis fan connector (4-pin CHA_FAN1)

Connect the fan cable to the fan connector on the motherboard, ensuring that the black wire of each cable matches the ground pin of the connector.

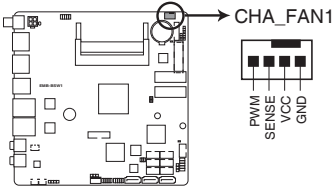

EMB-BSW1 Chassis fan connector



CAUTION: DO NOT forget to connect the fan cable to the fan connector. Insufficient air flow inside the system may damage the motherboard components. This is not a jumper! DO NOT place a jumper cap on the fan connector.

2. Embedded DisplayPort (40-pin EDP1)

This connector is for an internal embedded DisplayPort connection.

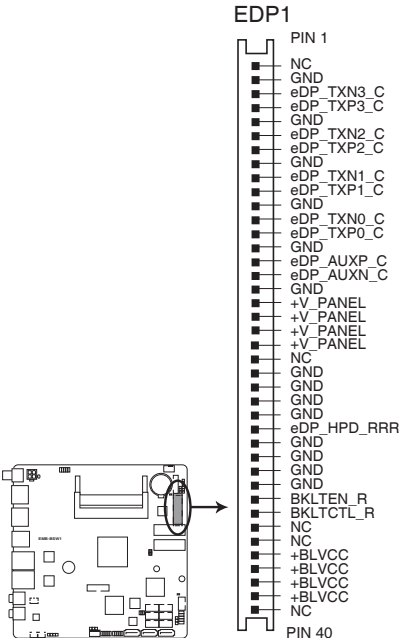

EMB-BSW1 Embedded DisplayPort

3. EATX power connector (4-pin EATX_PWR1)

This connector is for EATX power supply plug. The power supply plug is designed to fit this connector in only one orientation. Find the proper orientation and push down firmly until the connector completely fit.

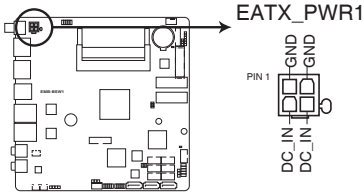

**EMB-BSW1 4-PIN (2x2)
internal power connector**

4. System panel connector (10-1 pin F_PANEL1)

This connector supports several chassis-mounted functions.

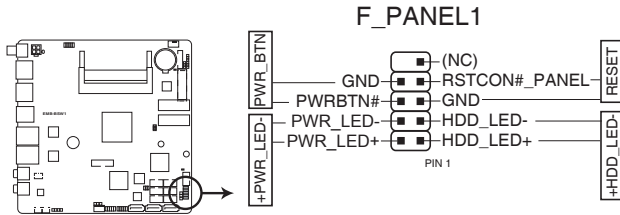

EMB-BSW1 System panel connector

- **System power LED (2-pin +PWR_LED1)**

This 2-pin connector is for the system power LED. Connect the chassis power LED cable to this connector. The system power LED lights up when you turn on the system power, and blinks when the system is in sleep mode.

- **Hard disk drive activity LED (2-pin +HD_LED-)**

This 2-pin connector is for the HDD Activity LED. Connect the HDD Activity LED cable to this connector. The IDE LED lights up or flashes when data is read from or written to the HDD.

- **ATX power button/soft-off button (2-pin PWR_BTN)**

This 2-pin connector is for the system power button.

- **Reset button (2-pin RESET)**

This 2-pin connector is for the chassis-mounted reset button for system reboot without turning off the system power.

5. Serial ATA 6.0Gb/s connector (7-pin SATA6G_1~3)

This connector connects to Serial ATA 6.0 Gb/s hard disk drives via Serial ATA 6.0 Gb/s signal cables.

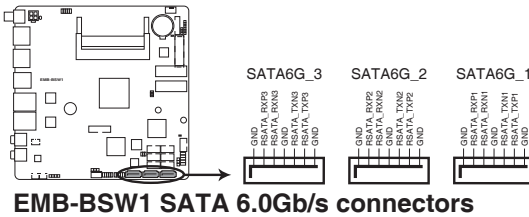

6. USB 2.0 connectors (10-pin USBHUB_12, USB9~12)

These connectors are for USB 2.0 ports. Connect the USB module cable to any of these connectors, then install the module to a slot opening at the back of the system chassis. These USB connectors comply with USB 2.0 specification that supports up to 480 Mbps connection speed.

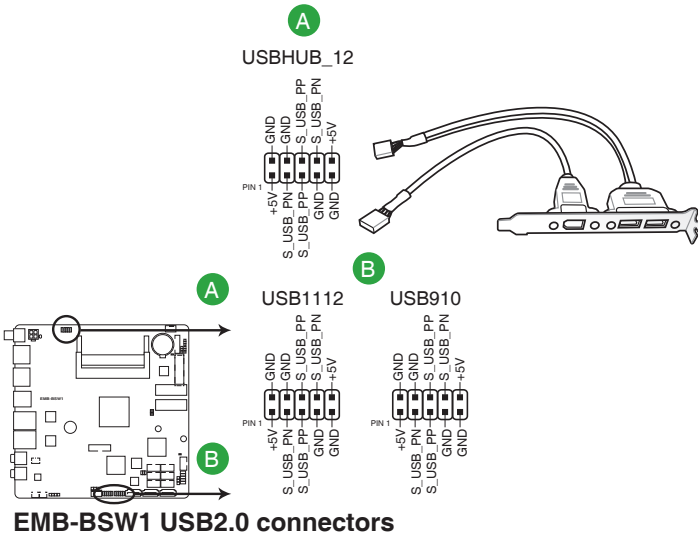

CAUTION! Never connect a 1394 cable to the USB connectors. Doing so will damage the motherboard!



NOTE: The USB module cable is purchased separately.

7. USB 3.0 connector (20-1 pin USB3_34)

This connector allows you to connect a USB 3.0 module for additional USB 3.0 front or rear panel ports. With an installed USB 3.0 module, you can enjoy all the benefits of USB 3.0 including faster data transfer speeds of up to 5 Gbps, faster charging time for USB-chargeable devices, optimized power efficiency, and backward compatibility with USB 2.0.

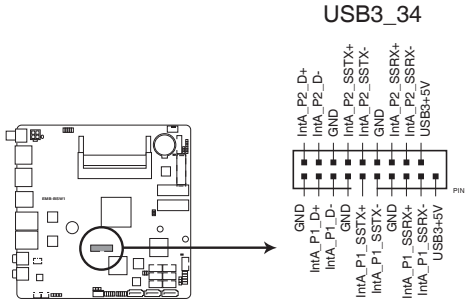

EMB-BSW1 USB3.0 Front panel connector



The USB 3.0 module is purchased separately.

8. LVDS connector (40-pin LVDS1)

This connector is for an LCD monitor that supports Low-voltage differential signaling (LVDS) interface.

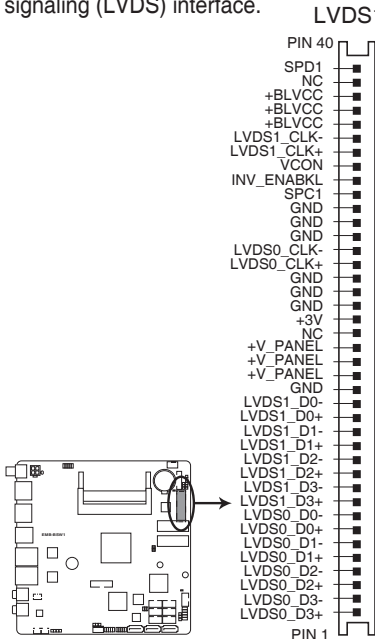

EMB-BSW1 LVDS connector

9. PS/2 keyboard/mouse connector (6-pin KBMS1)

This connector is for an IBM PS/2-compatible keyboard and mouse.

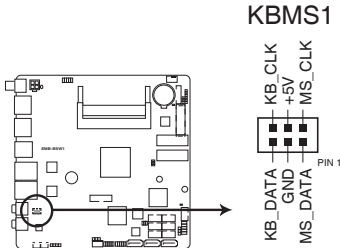

EMB-BSW1 PS/2 keyboard/mouse connector

10. Minicard connectors

Use these connectors to connect a Minicard device.

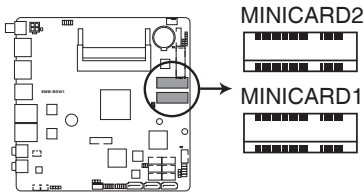

EMB-BSW1 MINICARD connectors



NOTE: The Minicard device is purchased separately.

11. SPI flash programmable connector (8-pin SPI1)

Use this connector to flash BIOS SPI ROM.

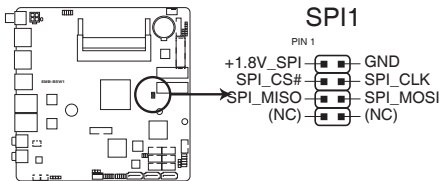

EMB-BSW1 SPI programming connector

12. Digital I/O connector (10-pin DIO1)

This connector includes 8 I/O lines (In/Out programmable). All of the Digital I/O lines are programmable and each I/O pin can be individually programmed to support various devices.

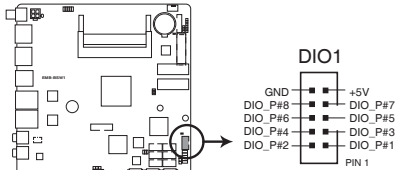

EMB-BSW1 DIO connector



NOTE: To configure the I/O pins in BIOS, go to the **Advanced** tab > **Digital IO Port Configuration** > **DIO Port 1-8**. See section 3.3.8 **Digital IO Port Configuration** for details.

13. SATA power connector (4-pin SATA_PWR1)

This connector is for the SATA power cable. The power cable plug is designed to fit this connector in only one orientation. Find the proper orientation and push down firmly until the connector completely fits.

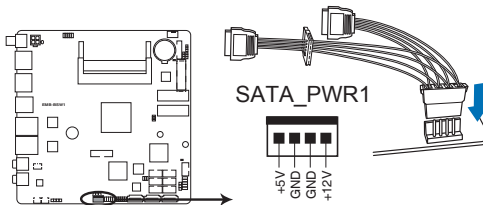

EMB-BSW1 SATA power connector

14. Backlight inverter power connector (9-pin INV1)

Connect the backlight inverter power cable to this connector.

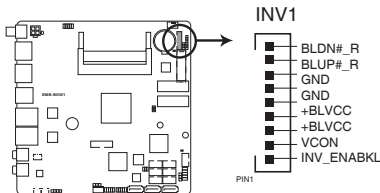

EMB-BSW1 Inverter connector



NOTE: The backlight inverter power cable is purchased separately.

15. Serial port connectors (9-pin COM1~6)

These connectors are for serial (COM) ports. Connect the serial port module cable to this connector, then install the module to a slot opening at the back of the system chassis.

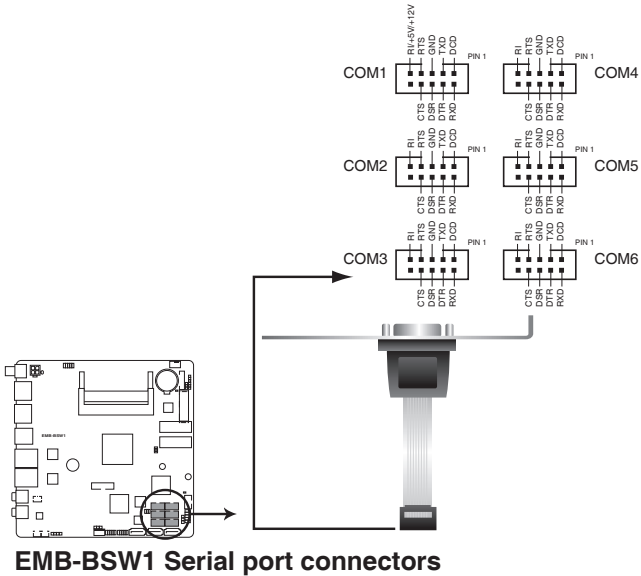

NOTES:

- The COM module is purchased separately.
- COM1 also supports RS-232 / RS-422 / RS-485. See the table below and section **3.3.6 SIO Configuration** for details.

Pin	Signal	Pin	Signal
1	DCD (422TXD-/485DATA-)	2	RXD (422RXD+)
3	TXD (422TXD+/485DATA+)	4	DTR (422RXD-)
5	GND	6	DSR
7	RTS	8	CTS
9	RI/+12V/+5V	10	N.C.

16. Internal audio connectors (2-pin SPK_L1, SPK_R1)

These 2-pin connectors are for audio connections. Connect the audio cable to these connectors for Line Out and Rear Speaker Out functions.

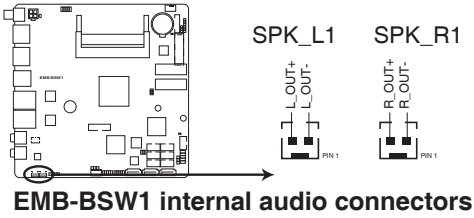

Chapter 3

BIOS setup

3.1 BIOS setup

Use the BIOS Setup to update the BIOS or configure settings. The BIOS screens include navigation keys and help to guide you in using the BIOS Setup program.

Entering BIOS Setup at startup

To enter BIOS Setup at startup:

Press <Delete> during the Power-On Self Test (POST). If you do not press <Delete>, POST continues with its routine.

Entering BIOS Setup after POST

To enter BIOS Setup after POST:

- Press <Ctrl>+<Alt>+ simultaneously.
- Press the reset button on the system chassis.
- Press the power button to turn the system off then back on. Do this option only if you failed to enter BIOS Setup using the first two options.



NOTE: Using the power button, reset button, or the <Ctrl>+<Alt>+ keys to reboot a running operating system can cause damage to your data or system. Always shut down the system properly from the operating system.



IMPORTANT:

- The default BIOS settings for this motherboard apply to most working conditions and ensures optimal performance. If the system becomes unstable after changing any BIOS settings, load the default settings to regain system stability. Select the option **Restore Defaults** under the Save & Exit Menu. See section **3.7 Save & Exit Menu**.
 - If the system fails to boot after changing any BIOS setting, try to clear the CMOS and reset the motherboard to the default value. See section **2.6 Jumpers** for information on how to erase the RTC RAM.
-

Menu bar

The menu bar on top of the screen has the following main items:

Main	For changing the basic system configuration.
Advanced	For changing the advanced system settings.
Chipset	For viewing and changing chipset settings.
Security	For setting up BIOS security settings.
Boot	For changing the system boot configuration.
Save & Exit	For selecting the exit options and loading default settings.

To select an item on the menu bar, press the right or left arrow key on the keyboard until the desired item is highlighted.

3.2 Main menu

The Main menu provides you an overview of the basic system information, and allows you to set the system date, time, language, and security settings.

3.2.1 System Date [Day MM/DD/YYYY]

Allows you to set the system date.

3.2.2 System Time [HH:MM:SS]

Allows you to set the system time.

3.3 Advanced menu

The Advanced menu items allow you to change the settings for the CPU and other system devices.



Be cautious when changing the settings of the Advanced menu items. Incorrect field values can cause the system to malfunction.

3.3.1 CPU Configuration

The items in this menu show CPU-related information.

Intel Virtualization Technology [Enabled]

[Enabled] Allows a hardware platform to run multiple operating systems separately and simultaneously, enabling one system to virtually function as several systems.

[Disabled] Disables this function.

3.3.2 SATA Configuration

While entering Setup, the BIOS automatically detects the presence of SATA devices. The SATA Port items show **Not Present** if no SATA device is installed to the corresponding SATA port.

3.3.3 USB Configuration

The items in this menu allow you to change the USB-related features.



The USB Devices item shows the auto-detected values. If no USB device is detected, the item shows **None**.

Legacy USB Support [Enabled]

- [Enabled] Enables the support for USB devices on legacy operating systems (OS).
- [Disabled] The USB devices can be used only for the BIOS setup program.
- [Auto] Allows the system to detect the presence of USB devices at startup. If detected, the USB controller legacy mode is enabled. If no USB device is detected, the legacy USB support is disabled.

3.3.4 Hardware Monitor

Smart Fan [Enabled]

Select Smart Fan control mode. Configuration options: [Enabled] [Disabled]



The following items appear only when you set Smart Fan to [Enabled].

Smart Fan Mode Configuration

Chassis Fan1 Mode [Auto Duty-Cycle Mode]

Configuration options: [Auto Duty-Cycle Mode] [Manual Duty Mode]



The following items appear only when you set Chassis Fan1 Mode to [Auto Duty-Cycle Mode].

Temperature Source [System]

Select the monitored temperature source for this fan. Configuration options: [System] [CPU(external)]

Temperature 1~4 [xx], Duty Cycle 1~5 [xx],

Auto fan speed control. The fan speed will follow different temperature by different duty cycle 1-100.



The following items appear only when you set Chassis Fan1 Mode to [Manual Duty Mode].

Manual Duty Mode [xx]

Specify fixed Duty-Cycle. Input value range: [1~100]

3.3.5 Trusted Computing

Security Device Support [Enable]

Allows you to enable or disable BIOS support for security devices. Configuration options: [Disable] [Enable]

TPM State [Enabled]

This item appears only when you set the **TPM Support** item to [Enabled] and allows you to enable or disable the TPM after POST. Reboot your system for the changes to take effect. Configuration options: [Disabled] [Enabled]

Pending operation [None]

Allows you to schedule an operation for security devices. Reboot your system for the changes to take effect. Configuration options: [None] [TPM Clear]

Device Select [Auto]

Allows you to schedule an operation for security devices. Reboot your system for the changes to take effect. Configuration options: [Auto] [TPM 1.2] [TPM 2.0]

[Auto] Select this item to support both TPM 1.2 and TPM 2.0 devices with default support of TPM 2.0 devices. If TPM 2.0 devices are not found, TPM 1.2 devices will be enumerated.

[TPM 1.2] Select this item to support TPM 1.2 devices only.

[TPM 2.0] Select this item to support TPM 2.0 devices only.

3.3.6 SIO Configuration

Serial Port 1

The sub-items in this menu allow you to set the serial port configuration.

Use This Device [Enabled]

Allows you to enable or disable the serial port (COM). Configuration options: [Enabled] [Disabled]

Possible [Use Automatic Settings]

Allows you to select the Serial Port base address. Configuration options: [Use Automatic Settings] [IO=3F8h; IRQ=4] [IO=2F8h; IRQ=3;]

Mode [RS232]

Allows you to select COM RS Mode. Configuration options: [RS232] [RS422] [RS485]

Serial Port 2~6

The sub-items in this menu allow you to set the serial port configuration.

Use This Device [Enabled]

Allows you to enable or disable the serial port (COM). Configuration options: [Enabled] [Disabled]

Possible [Use Automatic Settings]

Allows you to select the Serial Port base address. Configuration options: [Use Automatic Settings] [IO=3F8h; IRQ=4] [IO=2F8h; IRQ=3;]

3.3.7 Power Management

Power Mode [ATX Type]

This item selects Power Supply Mode. Configuration options: [ATX Type] [AT Type]

Power Saving (ERP) Control [Disabled]

Enable/disable ERP power saving function. Configuration options: [Enabled] [Disabled].

Restore AC Power Loss [Last State]

[Always On]	The system goes into on state after an AC power loss.
[Always Off]	The system goes into off state after an AC power loss.
[Last State]	The system goes into either off or on state, whatever the system state was before the AC power loss.

RI Wake Event [Enabled]

This item disables/enables resuming system on ring. Configuration options: [Disabled] [Enabled]

RTC wake system from S5 [Disabled]

Allows you to enable or disable system wake up on alarm event. When you select [Fixed Time], the system will wake up on a specified time. When you select [Dynamic Time], the system will wake up on the current time. Configuration options: [Disabled] [Fixed Time] [Dynamic Time]

3.3.8 Digital IO Port Configuration

The items in this menu allow you to modify Digital IO settings.

DIO Port 1~4 [Output]

Set DIO data flow as Input or Output. Configuration options: [Input] [Output]

Output Level [High]

Configuration options: [High][Low]

DIO Port 5-8 [Input]

Set DIO data flow as Input or Output. Configuration options: [Input] [Output]

3.4 Chipset menu

The Chipset menu items allow you to change configuration options for the North Bridge and South Bridge.

3.4.1 North Bridge

Primary IGFX Boot Display [Auto]

Allows you to decide which graphics controller to use as the primary boot device. Configuration options: [Auto] [HDMI1] [eDP/LVDS] [HDMI2]

LVDS [Enabled]

Enable or disable LVDS (CH7511). Configuration options: [Disabled] [Enabled]

LVDS Panel Type [1024x768, 18bit, 60Hz]

Select the type of LCD panel used as display. Configuration options: [640x480, 18bit, 60Hz] [800x480, 18bit, 60Hz] [800x600, 18bit, 60Hz] [1024x600, 18bit, 60Hz] [1024x768, 18bit, 60Hz] [1024x768, 24bit, 60Hz] [1280x768, 24bit, 60Hz] [1280x1024, 48bit, 60Hz] [1366x768, 24bit, 60Hz] [1440x900, 48bit, 60Hz] [1600x1200, 48bit, 60Hz] [1920x1080, 48bit, 60Hz] [1920x1200, 48bit, 60Hz] [1280x800, 24bit, 60Hz] [1280x800, 18bit, 60Hz]

3.4.2 South Bridge

Audio Controller [Enabled]

Configuration options: [Disabled] [Enabled]

PCIe Speed [Auto]

Configuration options: [Auto] [Gen 1] [Gen 2]

3.5 Security menu

The Security menu items allow you to change the system security settings.

3.5.1 Administrator Password

If you have set an administrator password, we recommend that you enter the administrator password for accessing the system. Otherwise, you might be able to see or change only selected fields in the BIOS setup program.

To set an administrator password:

1. Select the Administrator Password item and press <Enter>.
2. From the Create New Password box, key in a password, then press <Enter>.
3. Confirm the password when prompted.

To change an administrator password:

1. Select the Administrator Password item and press <Enter>.
2. From the Enter Current Password box, key in the current password, then press <Enter>.
3. From the Create New Password box, key in a new password, then press <Enter>.
4. Confirm the password when prompted.

To clear the administrator password, follow the same steps as in changing an administrator password, but press <Enter> when prompted to create/confirm the password. After you clear the password, the Administrator Password item on top of the screen shows Not Installed.

3.5.2 User Password

If you have set a user password, you must enter the user password for accessing the system. The User Password item on top of the screen shows the default Not Installed. After you set a password, this item shows Installed.

To set a user password:

1. Select the User Password item and press <Enter>.
2. From the Create New Password box, key in a password, then press <Enter>.
3. Confirm the password when prompted.

To change a user password:

1. Select the User Password item and press <Enter>.
2. From the Enter Current Password box, key in the current password, then press <Enter>.
3. From the Create New Password box, key in a new password, then press <Enter>.
4. Confirm the password when prompted.

To clear the user password, follow the same steps as in changing a user password, but press <Enter> when prompted to create/confirm the password. After you clear the password, the **User Password** item on top of the screen shows **Not Installed**.

3.6 Boot menu

The Boot menu items allow you to change the system boot options.

3.6.1 Boot Configuration

Quiet Boot [Enabled]

This item enables/disables Quiet Boot. Configuration options: [Disabled] [Enabled]

Launch PXE ROM [Disabled]

This item enables/disables the execution of UEFI and Legacy PXE OpROM.
Configuration options: [Disabled] [Enabled]

3.6.2 Boot Option Priorities

These items specify the boot device priority sequence from the available devices. The number of device items that appears on the screen depends on the number of devices installed in the system.



-
- To select the boot device during system startup, press <F7> during POST.
 - To access Windows OS in Safe Mode, press <F8> after POST.
-

3.7 Save & Exit menu

Save Changes and Reset

Once you are finished making your selections, choose this option from the Exit menu to ensure the values you selected are saved. When you select this option, a confirmation window appears. Select Yes to save changes and reboot system.

Discard Changes and Exit

This option allows you to exit the Setup program without saving your changes. When you select this option or if you press <Esc>, a confirmation window appears. Select Yes to discard changes and reboot system.

Restore Defaults

Save or restore User Defaults to all setup options.

Appendix

Notices

Federal Communications Commission Statement

This device complies with Part 15 of the FCC Rules. Operation is subject to the following two conditions:

- This device may not cause harmful interference.
- This device must accept any interference received including interference that may cause undesired operation.

This equipment has been tested and found to comply with the limits for a Class A digital device, pursuant to Part 15 of the FCC Rules. These limits are designed to provide reasonable protection against harmful interference in a residential installation. This equipment generates, uses and can radiate radio frequency energy and, if not installed and used in accordance with manufacturer's instructions, may cause harmful interference to radio communications. However, there is no guarantee that interference will not occur in a particular installation. If this equipment does cause harmful interference to radio or television reception, which can be determined by turning the equipment off and on, the user is encouraged to try to correct the interference by one or more of the following measures:

- Reorient or relocate the receiving antenna.
- Increase the separation between the equipment and receiver.
- Connect the equipment to an outlet on a circuit different from that to which the receiver is connected.
- Consult the dealer or an experienced radio/TV technician for help.



WARNING! The use of shielded cables for connection of the monitor to the graphics card is required to assure compliance with FCC regulations. Changes or modifications to this unit not expressly approved by the party responsible for compliance could void the user's authority to operate this equipment.



DO NOT throw the motherboard in municipal waste. This product has been designed to enable proper reuse of parts and recycling. This symbol of the crossed out wheeled bin indicates that the product (electrical and electronic equipment) should not be placed in municipal waste. Check local regulations for disposal of electronic products.



DO NOT throw the mercury-containing button cell battery in municipal waste. This symbol of the crossed out wheeled bin indicates that the battery should not be placed in municipal waste.



电子电气产品有害物质限制使用标识要求：图中之数字为产品之环保使用期限。仅指电子电气产品中含有的有害物质不致发生外泄或突变从而对环境造成污染或对人身、财产造成严重损害的期限。

部件名称	有害物质					
	铅 (Pb)	汞 (Hg)	镉 (Cd)	六价铬 (Cr(VI))	多溴联苯 (PBB)	多溴二苯醚 (PBDE)
印刷电路板及其电子组件	×	○	○	○	○	○
外壳	×	○	○	○	○	○
电源适配器	×	○	○	○	○	○
外部信号连接头及线材	×	○	○	○	○	○
中央处理器与内存	×	○	○	○	○	○

本表格依据 SJ/T 11364 的规定编制。

○：表示该有害物质在该部件所有均质材料中的含量均在 GB/T 26572 规定的限量要求以下。

×：表示该有害物质至少在该部件的某一均质材料中的含量超出 GB/T 26572 规定的限量要求，然该部件仍符合欧盟指令 2011/65/EU 的规范。

备注：此产品所标示之环保使用期限，系指在一般正常使用状况下。