

**EMB-APL3**

**Industrial Motherboard**

## Copyright Notice

This document is copyrighted, 2023. All rights are reserved. The original manufacturer reserves the right to make improvements to the products described in this manual at any time without notice.

No part of this manual may be reproduced, copied, translated, or transmitted in any form or by any means without the prior written permission of the original manufacturer. Information provided in this manual is intended to be accurate and reliable. However, the original manufacturer assumes no responsibility for its use, or for any infringements upon the rights of third parties that may result from its use. The material in this document is for product information only and is subject to change without notice. While reasonable efforts have been made in the preparation of this document to assure its accuracy, the original manufacturer assumes no liabilities resulting from errors or omissions in this document, or from the use of the information contained herein.

The original manufacturer reserves the right to make changes in the product design without notice to its users.

## Acknowledgments

All other products' name or trademarks are properties of their respective owners.

- AMI is a trademark of American Megatrends Inc.
- Intel®, Core™ are trademarks of Intel® Corporation.
- Microsoft Windows® is a registered trademark of Microsoft Corp.
- ITE is a trademark of Integrated Technology Express, Inc.
- IBM, PC/AT, PS/2, and VGA are trademarks of International Business Machines Corporation.

The original manufacturer reserves the right to make changes in the product design without notice to its users.

All other product names or trademarks are properties of their respective owners.

# Contents

## Chapter 1: Product overview

1.1	Package contents.....	1-1
1.2	Features .....	1-1
1.3	Specifications.....	1-2

## Chapter 2: Motherboard information

2.1	Before you proceed .....	2-1
2.2	Motherboard layout.....	2-2
2.3	Screw size.....	2-4
2.3.1	Component side .....	2-4
2.3.2	Solder side .....	2-5
2.4	Central Processing Unit (CPU) .....	2-6
2.5	System memory .....	2-6
2.6	Jumpers .....	2-7
2.7	Connectors .....	2-10
2.7.1	Rear panel connectors.....	2-10
2.7.2	Internal connectors .....	2-11

## Chapter 3: BIOS setup

3.1	BIOS setup.....	3-1
3.2	Main menu .....	3-2
3.2.1	System Date [Day MM/DD/YYYY] .....	3-2
3.2.2	System Time [HH:MM:SS] .....	3-2
3.3	Advanced menu .....	3-2
3.3.1	Trusted Computing .....	3-2
3.3.2	CPU Configuration .....	3-3
3.3.3	SATA Drives .....	3-4
3.3.4	USB Configuration .....	3-4
3.3.5	Hardware Monitor .....	3-5
3.3.6	SIO Configuration .....	3-7
3.3.7	Power Management.....	3-9
3.3.8	Digital IO Port Configuration .....	3-9
3.4	Chipset menu .....	3-9
3.4.1	North Bridge.....	3-9
3.5	Security menu .....	3-10
3.5.1	Administrator Password.....	3-10
3.5.2	User Password.....	3-11

# Contents

- 3.6 Boot menu ..... 3-11**
  - 3.6.1 Boot Configuration ..... 3-11
  - 3.6.2 Boot Option Priorities ..... 3-12
- 3.7 Save & Exit menu ..... 3-12**
  
- Appendix**
- Notices ..... A-1**

# Chapter 1

## Product overview

### 1.1 Package contents

Check your industrial motherboard package for the following items.

- 1 x Industrial Motherboard
- 1 x SATA cable
- 1 x SATA power cable
- 1 x I/O shield



---

**NOTE:** If any of the above items are damaged or missing, contact your distributor or sales representative immediately.

---

### 1.2 Features

- Integrated Intel® Apollo Lake Processor N4200 / N3350
- Two DDR3L 1333/1600 MTS SO-DIMM up to 8GB
- Realtek® ALC897-VB2-CG 6-Channel High Definition Audio CODEC
- 3 independent display: HDMI™, LVDS, and VGA (colay with DP)\*
- Dual Ethernet LAN: Realtek® 8111H PCIe Gb LAN x 2
- SATA 6.0 Gb/s x 2 (One colay with M.2 M Key), USB2.0 x 6, USB 3.2 Gen 1 x 4, COM x 6
- 1 x PCIe 2.0 [x1], 1 x M.2 M key (22 x 42mm) for SATA, and 1 x M.2 E Key (22 x 30mm) for PCIe



---

**\*NOTE:** Your motherboard comes with either VGA or DP port.

---

## 1.3 Specifications

SYSTEM	
CPU	N4200, (4C @ 2.50GHz CPU [Burst Mode], 750MHz GFX [Turbo], ~6W TDP) N3350, (2C @ 2.40GHz CPU [Burst Mode], 650MHz GFX [Turbo], ~6W TDP)
Memory	2 x SO-DIMM, max. 8GB, DDR3L 1333/1600 MTS, non-ECC, un-buffered memory
Graphics	Intel® HD Graphics
I/O Chipset	NCT6116D
LAN	2 x Realtek® 8111H PCIe Gb LAN
Audio	Realtek® ALC897-VB2-CG
TPM	—
Expansion slots	1 x PCIe 2.0 [x1] 1 x M.2 M key (22 x 42mm) for SATA 1 x M.2 E Key (22 x 30mm) for PCIe
BIOS	128Mb Flash ROM, AMI BIOS
H/W Status Monitor	Monitors CPU/system temperature Monitors Vcore, 3.3V/5V/12V voltages Monitors chassis fan speed
Watchdog Timer	1~255 steps by software program
Smart Fan Control	Chassis fan (fanless)
Wake On LAN / PXE	Yes ( WOL, PXE)
Power States	S3, S4, S5
Graphics	
Graphics Chipset	Intel® HD Graphics
Graphics Multi Display	3 independent display
VGA	Up to 1920 x 1200 @ 60 Hz
HDMI™	Up to 3840 x 2160 @ 30Hz
DP	Up to 4096 x 2160 @ 24Hz / 3840 x 2160 @ 60Hz
LVDS	Up to 1920 x 1200 @60Hz, Daul Channel 18/24 bit (via PS8625)
Backlight Control	Voltage / PWM, use HW control
Environment, Power, and ME	
Battery	Lithium battery
Power requirement	12V DC jack (screw type) 4-pin internal power connector
Operating temperature	32°F~140°F (0°C~60°C)
Operating humidity	0%~90% relative humidity, non-condensing
Certificate	CE & FCC Class A
Form factor	Mini-ITX form factor: 6.7 in. x 6.7 in. (17.0 cm x 17.0 cm)
Weight	1.1 lb (0.5 Kg)

(continued on the next page)

<b>I/O</b>	
<b>Storage</b>	2 x SATA 6Gb/s (1 colay with M.2) (default: 1 x SATA + M.2) 1 x SATA power connector (5V / 12V @ 1A)
<b>USB</b>	4 x USB 3.2 Gen 1 ports (at the back panel) 6 x USB 2.0 ports (at the mid-board)
<b>Display I/O</b>	1 x VGA (colay with DP), 1 x HDMI™, 1 x LVDS (via PS8625)
<b>Audio I/O</b>	Line-out, AAFP
<b>LAN I/O</b>	2 x RJ-45 ports on rear I/O
<b>Serial ports</b>	5 x RS-232 1 x RS-232/422/485 supports 5V/12V/RI option (COM1)
<b>PS/2 keyboard/ mouse</b>	1 x PS/2 header
<b>DIO</b>	8-bit Digital I/O interface (4-in / 4-out)
<b>Fan</b>	1 x Chassis fan connector (4-pin)
<b>I/O Placement</b>	
<b>Back panel I/O ports (Low profile)</b>	1 x DC jack 4 x USB 3.2 Gen 1 ports 1 x HDMI™ port (vertical type) 1 x DP (vertical type) (default: No)* 1 x VGA port* 2 x LAN (RJ-45) ports 1 x Audio jack (Line-out), lime * Your motherboard comes with either VGA or DP port.
<b>Internal I/O connectors</b>	1 x M.2 M key (22 x 42mm) for SATA 1 x M.2 E key (22 x 30mm) for PCIe 1 x PS/2 header 2 x SATA 6.0 Gb/s connectors (1 colay with M.2) 1 x SATA power connector 3 x USB 2.0 headers support additional 6 USB ports (2 x 5PIN, p=2.00mm) 1 x Chassis fan connector 1 x Chassis intrusion jumper 5 x boxer headers for COM (RS-232) 1 x boxer header for COM (RS-232 / 422 / 485) 1 x Digital I/O connector (4-in / 4-out) 1 x 40-pin LVDS connector (via PS8625) 1 x LVDS 3V / 5V selection jumper 1 x LCD DC / PWM mode selection jumper 1 x LCD backlight connector (inverter) 1 x LCD backlight 12V / 5V jumper 1 x Battery horizontal socket 1 x 2*2 PIN DCIN 12V AUX power connector 1 x System panel connector 1 x AAFP following ASUS pin out 1 x AT/ATX mode selection jumper 1 x CMOS jumper 1 x PCIe 2.0 [x1] slot

*(continued on the next page)*

Others	
Supported OS	Windows® 10 64-bit Ubuntu16.04.02 / Kernel4.8.0
Accessories	1 x SATA cable 1 x SATA power cable 1 x I/O shield



---

**NOTE:** Specifications are subject to change without notice.

---



# Chapter 2

## Motherboard information

### 2.1 Before you proceed

Take note of the following precautions before you install motherboard components or change any motherboard settings.



---

**CAUTION!**

- Unplug the power cord from the wall socket before touching any component.
  - Before handling components, use a grounded wrist strap or touch a safely grounded object or a metal object, such as the power supply case, to avoid damaging them due to static electricity.
  - Hold components by the edges to avoid touching the ICs on them.
  - Whenever you uninstall any component, place it on a grounded antistatic pad or in the bag that came with the component.
  - Before you install or remove any component, ensure that the power supply is switched off or the power cord is detached from the power supply. Failure to do so may cause severe damage to the motherboard, peripherals, or components.
-

## 2.2 Motherboard layout



**NOTE:** Place four screws into the holes indicated by circles to secure the motherboard to the chassis.



**CAUTION!** Do not overtighten the screws! Doing so can damage the motherboard.

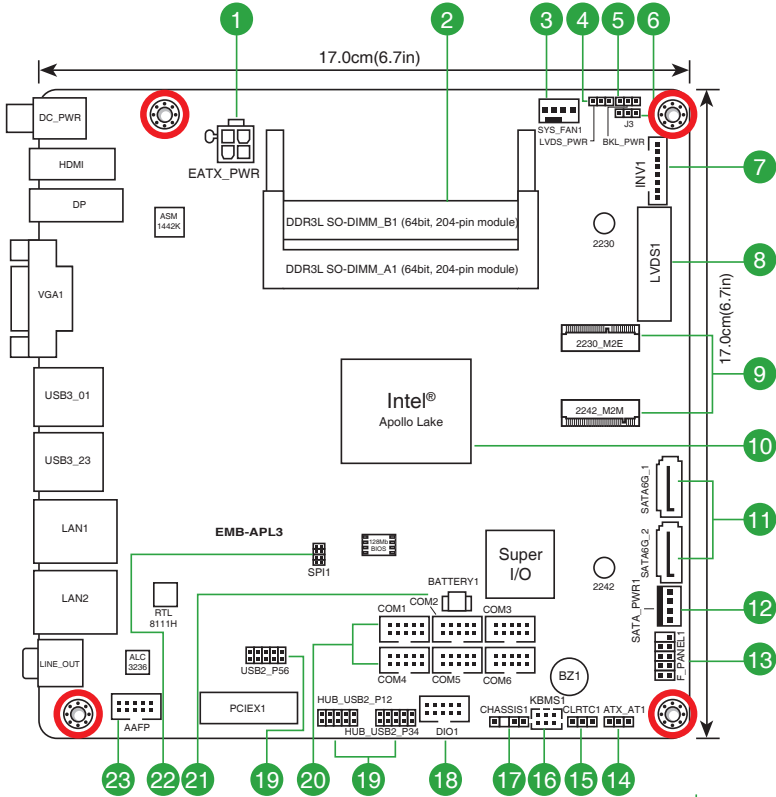

<b>Connectors/Jumpers/Slots/LEDs</b>		<b>Page</b>
1.	DCIN 12V AUX power connector (4-pin DC_PWR2)	2-12
2.	DDR3L SO-DIMM slots	2-6
3.	Chassis fan connector (4-pin SYS_FAN1)	2-11
4.	LVDS panel voltage selection jumper (3-pin LVDS_PWR)	2-7
5.	Inverter voltage selection jumper (3-pin BKL_PWR)	2-8
6.	Inverter backlight control mode selection jumper (3-pin J3)	2-8
7.	Backlight inverter power connector (8-pin INV1)	2-16
8.	LVDS connector (40-pin LVDS1)	2-14
9.	M.2 E Key and M Key slots	2-15
10.	Integrated Intel® Apollo Lake processor N4200/N3350	2-6
11.	Serial ATA 6.0Gb/s connectors (7-pin SATA6G_1~2)	2-13
12.	SATA power connector (4-pin SATA_PWR1)	2-16
13.	System panel connector (10-1 pin F_PANEL1)	2-12
14.	AT/ATX mode selection (3-pin ATX_AT1)	2-9
15.	Clear RTC RAM (3-pin CLRRTC1)	2-7
16.	PS/2 keyboard/mouse connector (6-pin KBMS1)	2-16
17.	Chassis intrusion jumper (4-1 pin CHASSIS1)	2-9
18.	Digital I/O connector (10-pin DIO1)	2-15
19.	USB 2.0 connectors (10-pin HUB_USB2_P12, HUB_USB2_P34, USB2_P56)	2-13
20.	Serial port connectors (10-pin COM1~6)	2-17
21.	Battery connector (2-pin BATTERY1)	2-18
22.	SPI programming connector (8-pin SPI1)	2-14
23.	Front panel audio connector (10-pin AAFP)	2-11

## 2.3 Screw size

### 2.3.1 Component side

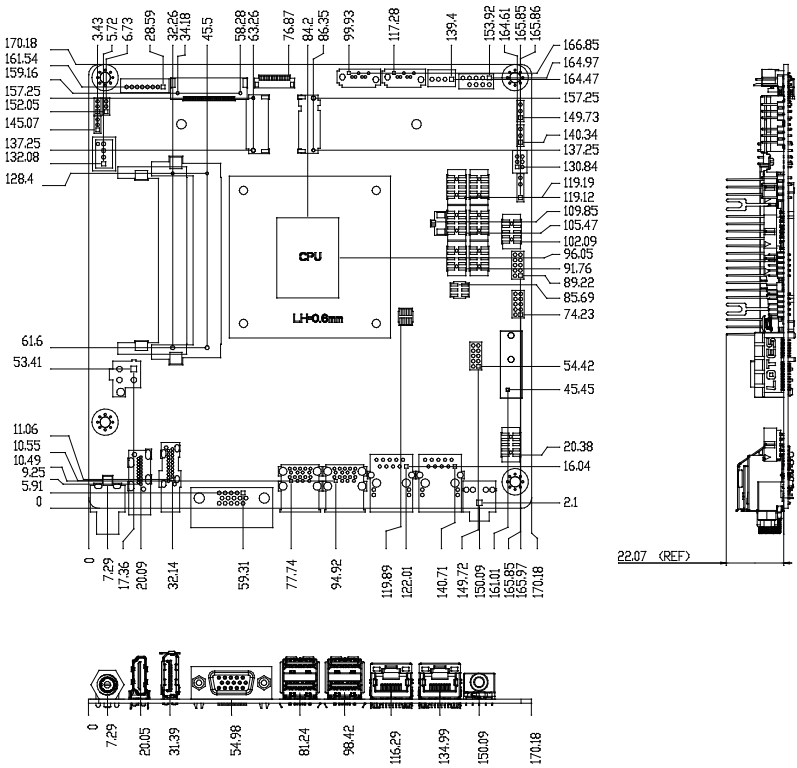

## 2.3.2 Solder side

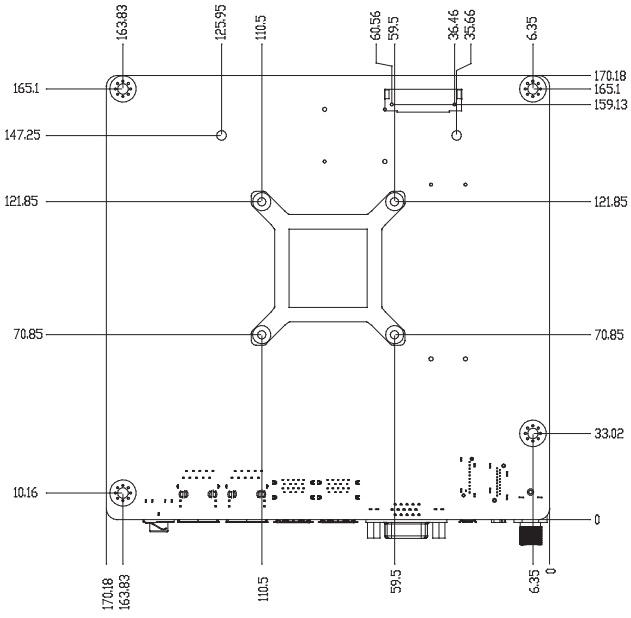

## 2.4 Central Processing Unit (CPU)

The motherboard comes with an integrated Intel® Apollo Lake processor N4200/ N3350.

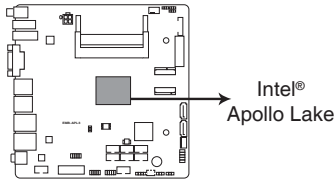

**EMB-APL3 CPU onboard**

## 2.5 System memory

This motherboard comes with two Double Data Rate 3 Low Voltage (DDR3L) Small Outline Dual Inline Memory Modules (SO-DIMM) sockets. The figure illustrates the location of the DDR3L DIMM sockets:

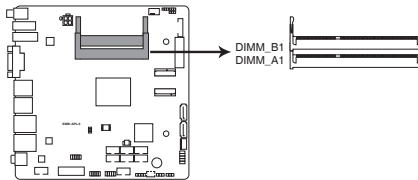

**EMB-APL3 204-pin  
DDR3L SO-DIMM sockets**

### Installing a DIMM

To install a DIMM

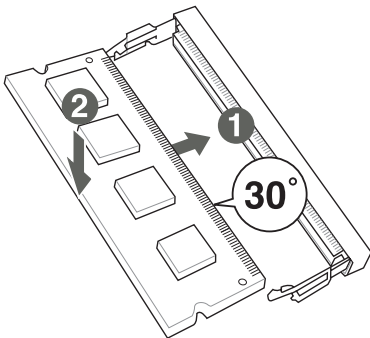

To remove a DIMM

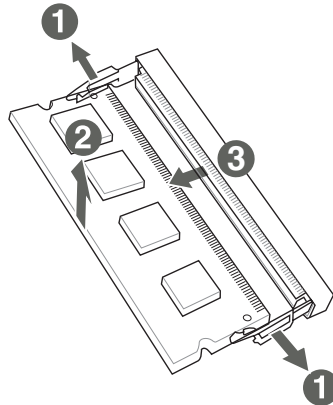

## 2.6 Jumpers

### 1. Clear RTC RAM (3-pin CLRTC1)

This jumper allows you to clear the Real Time Clock (RTC) RAM in CMOS. You can clear the CMOS memory of date, time, and system setup parameters by erasing the CMOS RTC RAM data. The onboard button cell battery powers the RAM data in CMOS, which include system setup information such as system passwords.

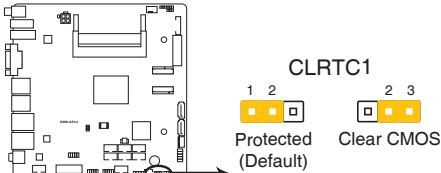

#### EMB-APL3 Clear RTC RAM

##### To erase the RTC RAM:

1. Turn OFF the computer and unplug the power cord.
2. Move the jumper cap from pins 1-2 (default) to pins 2-3. Keep the cap on pins 2-3 for about 5~10 seconds, then move the cap back to pins 1-2.
3. Plug the power cord and turn ON the computer.
4. Hold down the <Del> key during the boot process and enter BIOS setup to reenter data.



**CAUTION!** Except when clearing the RTC RAM, never remove the cap on CLRTC jumper default position. Removing the cap will cause system boot failure!



**NOTE:** If the steps above do not help, remove the onboard battery and move the jumper again to clear the CMOS RTC RAM data. After clearing the CMOS, reinstall the battery.

### 2. LVDS panel voltage selection jumper (3-pin LVDS\_PWR)

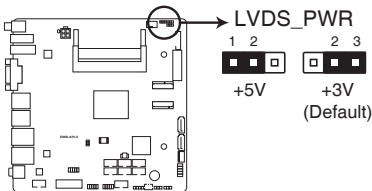

#### EMB-APL3 LVDS panel voltage selection

	Pins
+5V	1-2
+3V (Default)	2-3

3. Inverter voltage selection jumper (3-pin BKL\_PWR)

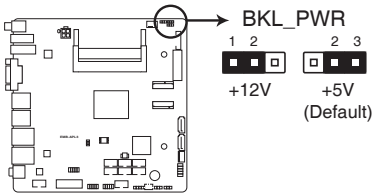

**EMB-APL3 Inverter voltage selection**

	Pins
+12V	1-2
+5V (Default)	2-3

4. Inverter backlight control mode selection jumper (3-pin J3)

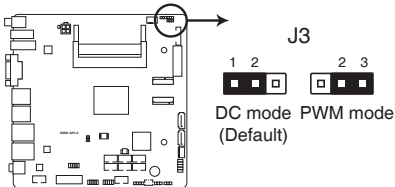

**EMB-APL3 Inverter backlight control mode selection**

	Pins
DC mode (Default)	1-2
PWM mode	2-3



**5. AT/ATX mode selection jumper (3-pin ATX\_AT1)**

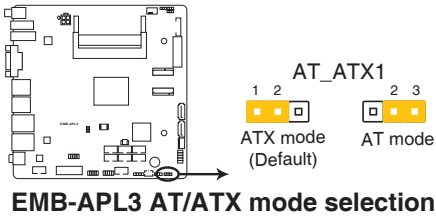

	Pins
ATX mode (Default)	1-2
AT mode	2-3

**6. Chassis intrusion jumper (4-1 pin CHASSIS1)**

This connector is for a chassis-mounted intrusion detection sensor or switch. Connect one end of the chassis intrusion sensor or switch cable to this connector. The chassis intrusion sensor or switch sends a high-level signal to this connector when a chassis component is removed or replaced. The signal is then generated as a chassis intrusion event.

Move the jumper cap to pins 1-2 when you intend to use the chassis intrusion detection feature.

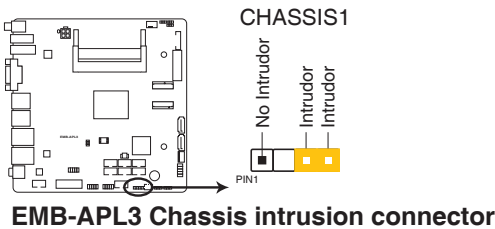

Pins	
1-2	Enables the chassis intrusion detection feature.
3-4	Disables the chassis intrusion detection feature (Default).

## 2.7 Connectors

### 2.7.1 Rear panel connectors

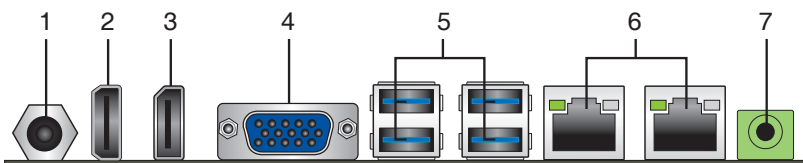

1. **DC power port.** This port connects to a DC power adapter.
2. **HDMI™ port.** This port is for a High-Definition Multimedia Interface (HDMI™) connector, and is HDCP compliant allowing playback of HD DVD, Blu-Ray, and other protected content.
3. **DisplayPort connector.** This port connects a device with DisplayPort connector.



**NOTE:** Your motherboard comes with either VGA or DP port.

4. **Video Graphics Adapter (VGA) port.** This 15-pin port is for a VGA monitor or other VGA-compatible devices.
5. **USB 3.2 Gen 1 ports.** These 9-pin Universal Serial Bus (USB) ports connect to USB 3.2 Gen 1/2.0 devices.



#### NOTES:

- USB 3.2 Gen 1 devices can be used for data storage only.
- Due to the design of the Intel® 300 series chipset, all USB devices connected to the USB 2.0 and USB 3.2 Gen 1 ports are controlled by the xHCI controller. Some legacy USB devices must update their firmware for better compatibility.
- We strongly recommend that you connect USB 3.2 Gen 1 devices to USB 3.2 Gen 1 ports for a faster and better performance from your USB 3.2 Gen 1 devices.

6. **LAN (RJ-45) ports.** These ports allow Gigabit connection to a Local Area Network (LAN) through a network hub. Refer to the table below for the LAN port LED indications.

#### LAN port LED indications

ACT/LINK LED		SPEED LED	
Status	Description	Status	Description
OFF	No link	OFF	10 Mbps connection
GREEN	Linked	ORANGE	100 Mbps connection
BLINKING	Data activity	GREEN	1 Gbps connection

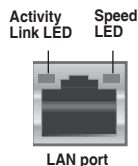

7. **Line Out port (lime).** This port connects to a headphone or a speaker. In the 4-channel and 6-channel configurations, the function of this port becomes Front Speaker Out.

## 2.7.2 Internal connectors

### 1. Chassis fan connector (4-pin SYS\_FAN1)

Connect the fan cable to the fan connector on the motherboard, ensuring that the black wire of each cable matches the ground pin of the connector.

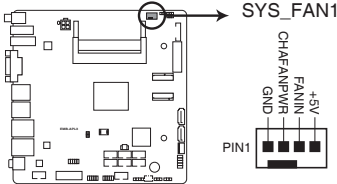

#### EMB-APL3 Fan connector



**CAUTION:** DO NOT forget to connect the fan cable to the fan connector. Insufficient air flow inside the system may damage the motherboard components. This is not a jumper! DO NOT place a jumper cap on the fan connector.

### 2. Front panel audio connector (10-pin AAFP)

This connector is for a chassis-mounted front panel audio I/O module that supports HD Audio audio standard. Connect one end of the front panel audio I/O module cable to this connector.

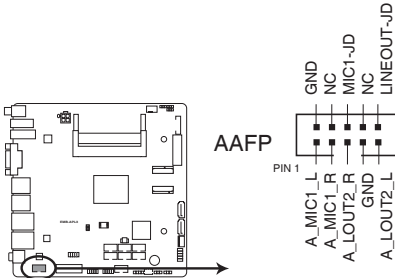

#### EMB-APL3 Front panel audio connector



**IMPORTANT:** We recommend that you connect a high-definition front panel audio module to this connector to avail of the motherboard's high-definition audio capability.

**3. DCIN 12V AUX power connector (4-pin EATX\_PWR)**

This port connects to a DCIN AUX supply plug. The power supply plug is designed to fit this connector in only one orientation. Find the proper orientation and push down firmly until the connector completely fits.

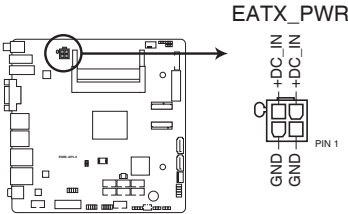

**EMB-APL3 DCIN AUX power connector**

**4. System panel connector (10-1 pin F\_PANEL1)**

This connector supports several chassis-mounted functions.

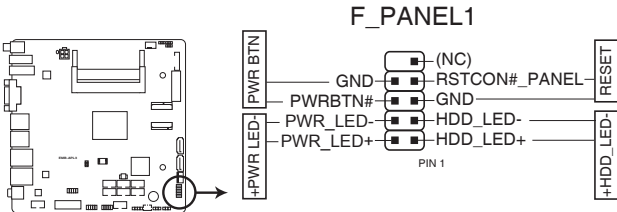

**EMB-APL3 System panel connector**

- **System power LED (2-pin +PWR\_LED-)**

This 2-pin connector is for the system power LED. Connect the chassis power LED cable to this connector. The system power LED lights up when you turn on the system power, and blinks when the system is in sleep mode.

- **Hard disk drive activity LED (2-pin +HDD\_LED-)**

This 2-pin connector is for the HDD Activity LED. Connect the HDD Activity LED cable to this connector. The IDE LED lights up or flashes when data is read from or written to the HDD.

- **ATX power button/soft-off button (2-pin PWR\_BTN)**

This 2-pin connector is for the system power button.

- **Reset button (2-pin RESET)**

This 2-pin connector is for the chassis-mounted reset button for system reboot without turning off the system power.

## 5. Serial ATA 6.0Gb/s connector (7-pin SATA6G\_1~2)

These connectors connect to Serial ATA 6.0 Gb/s hard disk drives via Serial ATA 6.0 Gb/s signal cables.

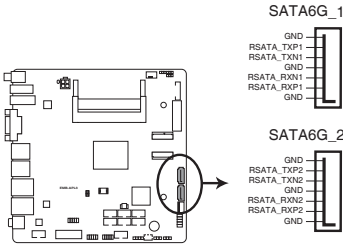

**EMB-APL3 SATA 6.0Gb/s connectors**

## 6. USB 2.0 connectors (10-pin USB2\_56, HUB\_USB2\_P12, HUB\_USB2\_P34)

These connectors are for USB 2.0 ports. Connect the USB module cable to any of these connectors, then install the module to a slot opening at the back of the system chassis. These USB connectors comply with USB 2.0 specification that supports up to 480 Mbps connection speed.

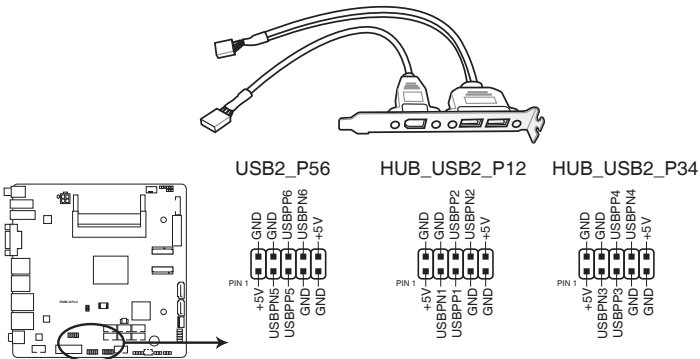

**EMB-APL3 USB2.0 connectors**



**CAUTION!** Never connect a 1394 cable to the USB connectors. Doing so will damage the motherboard!



**NOTE:** The USB module cable is purchased separately.

**7. LVDS connector (40-pin LVDS1)**

This connector is for an LCD monitor that supports Low-voltage differential signaling (LVDS) interface.

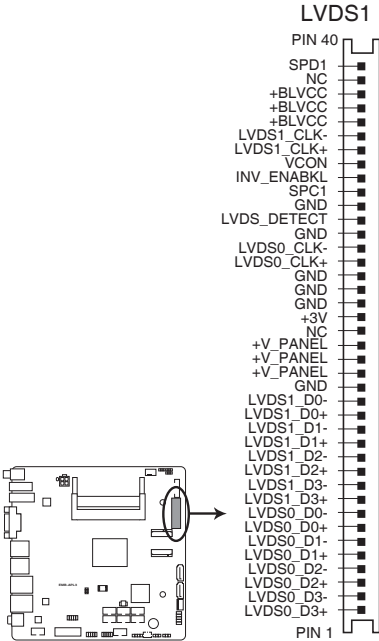

**EMB-APL3 LVDS connector**

**8. SPI programming connector (8-pin SPI1)**

Use this connector to flash BIOS SPI ROM.

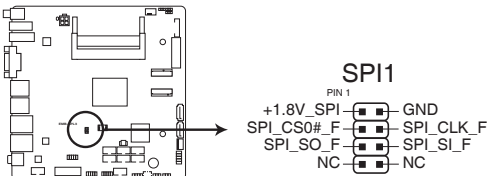

**EMB-APL3 SPI programming connector**

## 9. M.2 socket 3

The M2E1 socket allows you to install a PCIe interface M.2 (NGFF) E Key module.

The M2M1 socket allows you to install a SATA interface M.2 (NGFF) M Key SSD module.

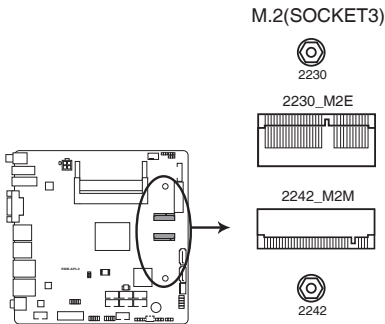

**EMB-APL3 M.2 sockets**



The M.2 (NGFF) module is purchased separately.

## 10. Digital I/O connector (10-pin DIO1)

This connector includes 8 I/O lines (In/Out programmable). All of the Digital I/O lines are programmable and each I/O pin can be individually programmed to support various devices.

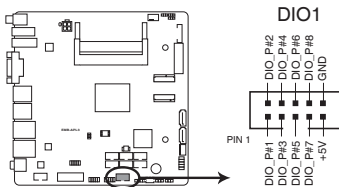

**EMB-APL3 Digital I/O connector**



**NOTE:** To configure the I/O pins in BIOS, go to the **Advanced** tab > **Digital IO Port Configuration** > **DIO Port 1~8**. See section 3.3.8 **Digital IO Port Configuration** for details.

### 11. PS/2 keyboard/mouse connector (6-pin KBMS1)

This connector is for an IBM PS/2-compatible keyboard and mouse.

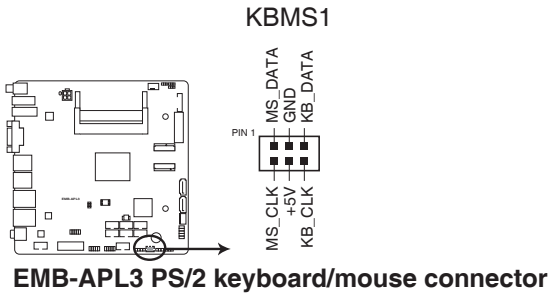

### 12. SATA power connector (4-pin SATA\_PWR1)

This connector is for the SATA power cable. The power cable plug is designed to fit this connector in only one orientation. Find the proper orientation and push down firmly until the connector completely fit.

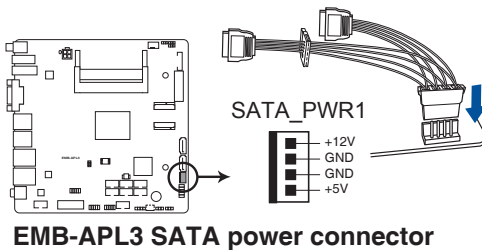

### 13. Backlight inverter power connector (8-pin INV1)

Connect the backlight inverter power cable to this connector.

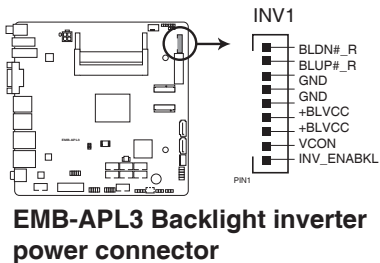

**NOTE:** The backlight inverter power cable is purchased separately.



## 14. Serial port connectors (10-pin COM1~6)

These connectors are for serial (COM) ports. Connect the serial port module cable to this connector, then install the module to a slot opening at the back of the system chassis.

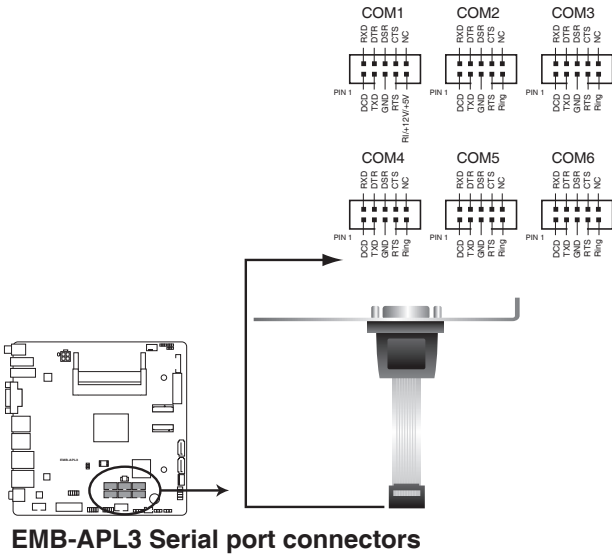

### NOTES:

- The COM module is purchased separately.
- COM1 also supports RS-232 / RS-422 / RS-485. See the table below and section **3.3.6 SIO Configuration** for details.

Pin	Signal	Pin	Signal
1	DCD (422TX-/485D-)	2	RXD (422TX+/485D+)
3	TXD (422RX+)	4	DTR (422RX-)
5	GND	6	DSR
7	RTS	8	CTS
9	RI/+12V/+5V	10	N.C.

## 15. Battery connector (2-pin BATTERY1)

This connector is for the lithium CMOS battery.

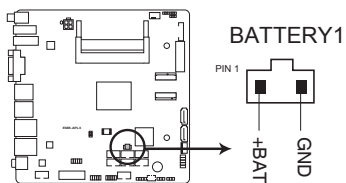

**EMB-APL3 Battery connector**

# Chapter 3

## BIOS setup

### 3.1 BIOS setup

Use the BIOS Setup to update the BIOS or configure settings. The BIOS screens include navigation keys and help to guide you in using the BIOS Setup program.

#### Entering BIOS Setup at startup

##### To enter BIOS Setup at startup:

Press <Delete> during the Power-On Self Test (POST). If you do not press <Delete>, POST continues with its routine.

#### Entering BIOS Setup after POST

##### To enter BIOS Setup after POST:

- Press <Ctrl>+<Alt>+<Del> simultaneously.
- Press the reset button on the system chassis.
- Press the power button to turn the system off then back on. Do this option only if you failed to enter BIOS Setup using the first two options.



---

**NOTE:** Using the power button, reset button, or the <Ctrl>+<Alt>+<Del> keys to reboot a running operating system can cause damage to your data or system. Always shut down the system properly from the operating system.

---



---

#### IMPORTANT:

- The default BIOS settings for this motherboard apply to most working conditions and ensures optimal performance. If the system becomes unstable after changing any BIOS settings, load the default settings to regain system stability. Select the option **Restore Defaults** under the Save & Exit Menu. See section **3.7 Save & Exit Menu**.
  - If the system fails to boot after changing any BIOS setting, try to clear the CMOS and reset the motherboard to the default value. See section **2.6 Jumpers** for information on how to erase the RTC RAM.
-

## Menu bar

The menu bar on top of the screen has the following main items:

<b>Main</b>	For changing the basic system configuration.
<b>Advanced</b>	For changing the advanced system settings.
<b>Chipset</b>	For viewing and changing chipset settings.
<b>Security</b>	For setting up BIOS security settings.
<b>Boot</b>	For changing the system boot configuration.
<b>Save &amp; Exit</b>	For selecting the exit options and loading default settings.

To select an item on the menu bar, press the right or left arrow key on the keyboard until the desired item is highlighted.

## 3.2 Main menu

The Main menu provides you an overview of the basic system information, and allows you to set the system date and time.

### 3.2.1 System Date [Day MM/DD/YYYY]

Allows you to set the system date.

### 3.2.2 System Time [HH:MM:SS]

Allows you to set the system time.

## 3.3 Advanced menu

The Advanced menu items allow you to change the settings for the CPU and other system devices.



---

Be cautious when changing the settings of the Advanced menu items. Incorrect field values can cause the system to malfunction.

---

### 3.3.1 Trusted Computing

#### Security Device Support [Enable]

Allows you to enable or disable BIOS support for security devices. Configuration options: [Disable] [Enable]

#### SHA-1 PCR Bank [Enabled]

Allows you to enable or disable SHA-1 PCR Bank. Configuration options: [Enabled] [Disabled]

### **SHA256 PCR Bank [Enabled]**

Allows you to enable or disable SHA256 PCR Bank. Configuration options: [Enabled] [Disabled]

### **Pending operation [None]**

Allows you to schedule an operation for security devices. Reboot your system for the changes to take effect. Configuration options: [None] [TPM Clear]

### **Platform Hierarchy [Enabled]**

Allows you to enable or disable Platform Hierarchy. Configuration options: [Enabled] [Disabled]

### **Storage Hierarchy [Enabled]**

Allows you to enable or disable Storage Hierarchy. Configuration options: [Enabled] [Disabled]

### **Endorsement Hierarchy [Enabled]**

Allows you to enable or disable Endorsement Hierarchy. Configuration options: [Enabled] [Disabled]

### **TPM2.0 UEFI Spec Version [TCG\_2]**

Allows you to select the TCG2 spec version support.

- [TCG\_1\_2]            Compatible mode for Windows® 8 / Windows® 10.
- [TCG\_2]            Newer TCG2 protocol and event format for Windows® 10 or later.

### **Physical Presence Spec Version [1.3]**

Allows you to select which TCG Physical Presence Interface Specification Version is supported by the OS. Configuration options: [1.2] [1.3]

### **Device Select [Auto]**

Allows you to schedule an operation for security devices. Reboot your system for the changes to take effect. Configuration options: [Auto] [TPM 1.2] [TPM 2.0]

- [Auto]              Select this item to support both TPM 1.2 and TPM 2.0 devices with default support of TPM 2.0 devices. If TPM 2.0 devices are not found, TPM 1.2 devices will be enumerated.

## **3.3.2 CPU Configuration**

The items in this menu show CPU-related information.

### **Intel Virtualization Technology [Enabled]**

- [Enabled]            Allows a hardware platform to run multiple operating systems separately and simultaneously, enabling one system to virtually function as several systems.

- [Disabled]           Disables this function.

### **VT-d [Enabled]**

Allows you to enable or disable the CPU VT-d function. Configuration options: [Enabled] [Disabled]

### **Power Limit 1 Enable [Enabled]**

Allows you to enable or disable Power Limit 1. Configuration options: [Enabled] [Disabled]

### **Power Limit 1 Clamp Mode [Enabled]**

Allows you to enable or disable Power Limit 1 Clamp Mode. Configuration options: [Enabled] [Disabled]

### **Power Limit 1 Power [Auto]**

Allows you to set Power Limit 1 in watts. When Auto is selected, Power Limit 1 is decided by the default silicon support value. Configuration options: [Auto] [6] ~ [25]

### **Power Limit 1 Time Window [Auto]**

Allows you to set Power Limit 1 Time Window in seconds. When Auto is selected, Power Limit 1 Time Window is decided by the default silicon support value.

Configuration options: [Auto] [1] [2] [3] [4] [5] [6] [7] [8] [10] [12] [14] [16] [20] [24] [28] [32] [40] [48] [56] [64] [80] [96] [112]

## **3.3.3 SATA Drives**

While entering Setup, the BIOS automatically detects the presence of SATA devices. The SATA Port items show **Not Installed** if no SATA device is installed to the corresponding SATA port.

### **Chipset SATA [Enable]**

Allows you to enable or disable the chipset SATA controller. Configuration options: [Enable] [Disable]

## **3.3.4 USB Configuration**

The items in this menu allow you to change the USB-related features.



---

The USB Devices item shows the auto-detected values. If no USB device is detected, the item shows **None**.

---

### **Legacy USB Support [Enabled]**

[Enabled]

Enables the support for USB devices on legacy operating systems (OS).

[Disabled]

The USB devices can be used only for the BIOS setup program.

[Auto]

Allows the system to detect the presence of USB devices at startup. If detected, the USB controller legacy mode is enabled. If no USB device is detected, the legacy USB support is disabled.

### 3.3.5 Hardware Monitor

#### Smart Fan Configuration

##### CPU Smart Fan Control [Disabled]

Allows you to enable or disable CPU Smart Fan Control. Configuration options: [Enabled] [Disabled]



---

The following sub-items appear only when you set **CPU Smart Fan Control** to [Enabled].

---

##### Fan Control Mode [Manual Mode]

Configuration options: [Manual Mode] [Thermal Cruise Mode] [Speed Cruise Mode] [Smart Fan IV Mode]



---

The following item appears only when you set Fan Control Mode to [Manual Mode].

---

##### PWM/DC Voltage Output [255]

Sets the voltage allocated for Fan Control. Input value range: [0~255]



---

The following items appear only when you set Fan Control Mode to [Thermal Cruise Mode].

---

##### Temperature Source [CPUTIN]

Allows you to select the temperature source. Configuration options: [SYSTIN] [CPUTIN] [AUXTIN0] [AUXTIN1] [AUXTIN2] [AUXTIN3] [SMBUSMASTER 0] [SMBUSMASTER 1] [SMBUSMASTER 2] [SMBUSMASTER 3] [SMBUSMASTER 4] [SMBUSMASTER 5] [SMBUSMASTER 6] [SMBUSMASTER 7] [PECI Agent 0] [PECI Agent 1] [PCH\_CHIP\_CPU\_MAX\_TEMP] [PCH\_CHIP\_TEMP] [PCH\_CPU\_TEMP] [PCH\_MCH\_TEMP] [PCH\_DIM0\_TEMP] [PCH\_DIM1\_TEMP] [PCH\_DIM2\_TEMP] [PCH\_DIM3\_TEMP] [BYTE\_TEMP]

##### Target Temperature [50]

Input value range: [0~127]

##### Tolerance of Temperature [0]

Input value range: [0~7]

##### Fan Out Start-Up Value [127]

Input value range: [0~255]

##### Fan Stop Duty [Down to 0]

[Down to 0] Fan Out will decrease to 0 at most if necessary.  
[To Fan Out Stop Value] Uses the same value as Fan Out Stop Value.

### **Fan Out Stop Value [100]**

The Fan Out value decreases to this value if the temperature reaches below the lowest temperature limit. Input value range: [0~255]

### **Fan Out Stop Time [60]**

Determines the amount of time it takes for the Fan Out value to fall from the stop value to zero. Input value range: [0~255]

### **Critical Temperature [75]**

Determines the amount of time Fan Out takes to decrease its value by one step. Input value range: [0~255]

### **Fan Out Step Up Time [10]**

Determines the amount of time Fan Out takes to increase its value by one step. Input value range: [0~255]

### **Fan Out Step Down Time [10]**

Determines the amount of time Fan Out takes to decrease its value by one step in intervals of 0.1 seconds. Input value range: [0~255]



---

The following items appear only when you set **Fan Control Mode** to [Speed Cruise Mode].

---

### **Target Speed [0]**

Input value range: [0~4096]

### **Speed Tolerance [2]**

Input value range: [0~64]

### **Fan Out Step Up Time [10]**

Input value range: [0~255]

### **Fan Out Step Down Time [10]**

Input value range: [0~255]



---

The following items appear only when you set **Fan Control Mode** to [Smart Fan IV Mode].

---

### **Temperature Source [CPUTIN]**

Allows you to select the temperature source. Configuration options: [SYSTIN] [CPUTIN] [AUXTIN0] [AUXTIN1] [AUXTIN2] [AUXTIN3] [SMBUSMASTER 0] [SMBUSMASTER 1] [SMBUSMASTER 2] [SMBUSMASTER 3] [SMBUSMASTER 4] [SMBUSMASTER 5] [SMBUSMASTER 6] [SMBUSMASTER 7] [PECI Agent 0] [PECI Agent 1] [PCH\_CHIP\_CPU\_MAX\_TEMP] [PCH\_CHIP\_TEMP] [PCH\_CPU\_TEMP] [PCH\_MCH\_TEMP] [PCH\_DIM0\_TEMP] [PCH\_DIM1\_TEMP] [PCH\_DIM2\_TEMP] [PCH\_DIM3\_TEMP] [BYTE\_TEMP]



**Close-Loop Fan Mode [Disabled]**

Allows you to enable or disable Smart Fan IV Close-Loop Fan Mode.  
Configuration options: [Enabled] [Disabled]

**Temperature 1~4 [xx]**

Input temperature setting. The values range from 0~255.

**Fan PWM 1~4 [xx]**

Input the amount of Fan PWM 4 for Smart Fan IV Mode. The values range from 0~255.

**Tolerance of Temperature [0]**

Input the tolerance of target temperature. The values range from 0~7.

**Critical Temperature [75]**

Determines the time that Fan Out takes to decrease its value by one step.  
The values range from 0~255.

**Critical Temp Tolerance [0]**

Input the tolerance of critical temperature. The values range from 0~7.

**Fan Out Step Up Time [10]**

Input value range: [0~255]

**Fan Out Step Down Time [10]**

Input value range: [0~255]

### 3.3.6 SIO Configuration

**[\*Active\*] Serial Port 1**

The sub-items in this menu allow you to set the serial port configuration.

**Use This Device [Enabled]**

Allows you to enable or disable the serial port (COM). Configuration options:  
[Enabled] [Disabled]

**Possible [Use Automatic Settings]**

Allows you to select the Serial Port base address. Configuration options: [Use Automatic Settings] [IO=3F8h; IRQ=4;] [IO=2F8h; IRQ=3;]

**Mode [RS232]**

Allows you to select COM RS Mode. Configuration options: [RS232] [RS422] [RS485]

**[\*Active\*] Serial Port 2**

The sub-items in this menu allow you to set the serial port configuration.

**Use This Device [Enabled]**

Allows you to enable or disable the serial port (COM). Configuration options:  
[Enabled] [Disabled]

**Possible [Use Automatic Settings]**

Allows you to select the Serial Port base address. Configuration options: [Use Automatic Settings] [IO=2F8h; IRQ=3;] [IO=3F8h; IRQ=4;]

**[\*Active\*] Serial Port 3**

The sub-items in this menu allow you to set the serial port configuration.

**Use This Device [Enabled]**

Allows you to enable or disable the serial port (COM). Configuration options: [Enabled] [Disabled]

**Possible [Use Automatic Settings]**

Allows you to select the Serial Port base address. Configuration options: [Use Automatic Settings] [IO=2F0h; IRQ=6;] [IO=2E0h; IRQ=6;]

**[\*Active\*] Serial Port 4**

The sub-items in this menu allow you to set the serial port configuration.

**Use This Device [Enabled]**

Allows you to enable or disable the serial port (COM). Configuration options: [Enabled] [Disabled]

**Possible [Use Automatic Settings]**

Allows you to select the Serial Port base address. Configuration options: [Use Automatic Settings] [IO=2E8h; IRQ=7;] [IO=3E8h; IRQ=7;]

**[\*Active\*] Serial Port 5**

The sub-items in this menu allow you to set the serial port configuration.

**Use This Device [Enabled]**

Allows you to enable or disable the serial port (COM). Configuration options: [Enabled] [Disabled]

**Possible [Use Automatic Settings]**

Allows you to select the Serial Port base address. Configuration options: [Use Automatic Settings] [IO=2D0h; IRQ=10;] [IO=2C0h; IRQ=10;]

**[\*Active\*] Serial Port 6**

The sub-items in this menu allow you to set the serial port configuration.

**Use This Device [Enabled]**

Allows you to enable or disable the serial port (COM). Configuration options: [Enabled] [Disabled]

**Possible [Use Automatic Settings]**

Allows you to select the Serial Port base address. Configuration options: [Use Automatic Settings] [IO=2C0h; IRQ=11;] [IO=2D0h; IRQ=11;]

### 3.3.7 Power Management

#### Power Mode [ATX Type]

This item selects Power Supply Mode. Configuration options: [ATX Type] [AT Type]

#### Restore AC Power Loss [Always Off]

- [Always On] The system goes into on state after an AC power loss.
- [Always Off] The system goes into off state after an AC power loss.
- [Last State] The system goes into either off or on state, whatever the system state was before the AC power loss.

#### RTC wake system from S5 [Disabled]

Allows you to enable or disable system wake up on alarm event. When you select [Fixed Time], the system will wake up on a specified time. When you select [Dynamic Time], the system will wake up on the current time. Configuration options: [Disabled] [Fixed Time] [Dynamic Time]

### 3.3.8 Digital IO Port Configuration

The items in this menu allow you to modify Digital IO settings.

#### DIO Port 1~4 [Output]

Set DIO data flow as Input or Output. Configuration options: [Input] [Output]

##### Output Level [High]

Configuration options: [High][Low]

#### DIO Port 5~8 [Input]

Set DIO data flow as Input or Output. Configuration options: [Input] [Output]

## 3.4 Chipset menu

The Chipset menu items allow you to change configuration options for the North Bridge and South Bridge.

### 3.4.1 North Bridge

#### Primary Display [IGD]

Allows you to decide which graphics controller to use as the primary boot device. Configuration options: [IGD] [PCIe]

#### Primary IGFX Boot Display [Auto]

Allows you to decide which graphics controller to use as the primary boot device. Configuration options: [Auto] [HDMI1] [eDP/LVDS] [CRT]

### **PCIe Speed [Auto]**

Allows you to configure the PCIe speed. Configuration options: [Auto] [Gen1] [Gen2]

### **LVDS Panel Support [Enabled]**

Enables or disables LVDS panel support. Configuration options: [Disabled] [Enabled]

### **LVDS Color Depth [24-bit]**

Select the color depth of the LCD panel to be used as display. Configuration options: [24-bit] [18-bit]

### **LVDS Channel Type [Single]**

Select the channel type of the LCD panel to be used as display. Configuration options: [Single] [Dual]

### **LVDS Brightness Type [Normal]**

Allows you to select the LVDS brightness type. Configuration options: [Normal] [Inverted]

### **LVDS Brightness Level [80%]**

Allows you to select the LVDS brightness level. Configuration options: [0%] ~ [80%] [90%] [100%]

### **IGD Flat Panel [1024x768]**

Configuration options: [640x480] [800x600] [1024x768] [1280x1024] [1440x1050 (RB) LVDS1] [1440x1050 LVDS2] [1600x1200 LVDS] [1366x768 LVDS] [1680x1050] [1920x1200] [1440x900 LVDS] [1600x900 LVDS] [1024x768 LVDS2] [1280x800] [1920x1080 LVDS] [2048x1536 LVDS]

## **3.5 Security menu**

The Security menu items allow you to change the system security settings.

### **3.5.1 Administrator Password**

If you have set an administrator password, we recommend that you enter the administrator password for accessing the system. Otherwise, you might be able to see or change only selected fields in the BIOS setup program.

#### **To set an administrator password:**

1. Select the Administrator Password item and press <Enter>.
2. From the Create New Password box, key in a password, then press <Enter>.
3. Confirm the password when prompted.

#### **To change an administrator password:**

1. Select the Administrator Password item and press <Enter>.
2. From the Enter Current Password box, key in the current password, then press <Enter>.

3. From the Create New Password box, key in a new password, then press <Enter>.
4. Confirm the password when prompted.

To clear the administrator password, follow the same steps as in changing an administrator password, but press <Enter> when prompted to create/confirm the password. After you clear the password, the Administrator Password item on top of the screen shows Not Installed.

### 3.5.2 User Password

If you have set a user password, you must enter the user password for accessing the system. The User Password item on top of the screen shows the default Not Installed. After you set a password, this item shows Installed.

#### To set a user password:

1. Select the User Password item and press <Enter>.
2. From the Create New Password box, key in a password, then press <Enter>.
3. Confirm the password when prompted.

#### To change a user password:

1. Select the User Password item and press <Enter>.
2. From the Enter Current Password box, key in the current password, then press <Enter>.
3. From the Create New Password box, key in a new password, then press <Enter>.
4. Confirm the password when prompted.

To clear the user password, follow the same steps as in changing a user password, but press <Enter> when prompted to create/confirm the password. After you clear the password, the **User Password** item on top of the screen shows **Not Installed**.

## 3.6 Boot menu

The Boot menu items allow you to change the system boot options.

### 3.6.1 Boot Configuration

#### Quiet Boot [Enabled]

This item enables/disables Quiet Boot. Configuration options: [Disabled] [Enabled]

#### Network Stack [Enabled]

This item allows user to disable or enable the UEFI network stack. Configuration options: [Disabled] [Enabled]

## 3.6.2 Boot Option Priorities

These items specify the boot device priority sequence from the available devices. The number of device items that appears on the screen depends on the number of devices installed in the system.



- 
- To select the boot device during system startup, press <F7> during POST.
  - To access Windows OS in Safe Mode, press <F8> after POST.
- 

## 3.7 Save & Exit menu

### Save Changes and Reset

Once you are finished making your selections, choose this option from the Exit menu to ensure the values you selected are saved. When you select this option, a confirmation window appears. Select Yes to save changes and reboot system.

### Discard Changes and Exit

This option allows you to exit the Setup program without saving your changes. When you select this option or if you press <Esc>, a confirmation window appears. Select Yes to discard changes and reboot system.

### Restore Defaults

Save or restore User Defaults to all setup options.

# Appendix

## Notices

### Federal Communications Commission Statement

This device complies with Part 15 of the FCC Rules. Operation is subject to the following two conditions:

- This device may not cause harmful interference.
- This device must accept any interference received including interference that may cause undesired operation.

This equipment has been tested and found to comply with the limits for a Class A digital device, pursuant to Part 15 of the FCC Rules. These limits are designed to provide reasonable protection against harmful interference in a residential installation. This equipment generates, uses and can radiate radio frequency energy and, if not installed and used in accordance with manufacturer's instructions, may cause harmful interference to radio communications. However, there is no guarantee that interference will not occur in a particular installation. If this equipment does cause harmful interference to radio or television reception, which can be determined by turning the equipment off and on, the user is encouraged to try to correct the interference by one or more of the following measures:

- Reorient or relocate the receiving antenna.
- Increase the separation between the equipment and receiver.
- Connect the equipment to an outlet on a circuit different from that to which the receiver is connected.
- Consult the dealer or an experienced radio/TV technician for help.



---

**WARNING!** The use of shielded cables for connection of the monitor to the graphics card is required to assure compliance with FCC regulations. Changes or modifications to this unit not expressly approved by the party responsible for compliance could void the user's authority to operate this equipment.

---



---

DO NOT throw the motherboard in municipal waste. This product has been designed to enable proper reuse of parts and recycling. This symbol of the crossed out wheeled bin indicates that the product (electrical and electronic equipment) should not be placed in municipal waste. Check local regulations for disposal of electronic products.

---



---

DO NOT throw the mercury-containing button cell battery in municipal waste. This symbol of the crossed out wheeled bin indicates that the battery should not be placed in municipal waste.

---



电子电气产品有害物质限制使用标识要求：图中之数字为产品之环保使用期限。仅指电子电气产品中含有的有害物质不致发生外泄或突变从而对环境造成污染或对人身、财产造成严重损害的期限。

部件名称	有害物质					
	铅 (Pb)	汞 (Hg)	镉 (Cd)	六价铬 (Cr(VI))	多溴联苯 (PBB)	多溴二苯醚 (PBDE)
印刷电路板及其电子组件	×	○	○	○	○	○
外壳	×	○	○	○	○	○
电源适配器	×	○	○	○	○	○
外部信号连接头及线材	×	○	○	○	○	○
中央处理器与内存	×	○	○	○	○	○

本表格依据 SJ/T 11364 的规定编制。

○：表示该有害物质在该部件所有均质材料中的含量均在 GB/T 26572 规定的限量要求以下。

×：表示该有害物质至少在该部件的某一均质材料中的含量超出 GB/T 26572 规定的限量要求，然该部件仍符合欧盟指令 2011/65/EU 的规范。

备注：此产品所标示之环保使用期限，系指在一般正常使用状况下。