

EMB-BSW2

Industrial Motherboard

Copyright Notice

This document is copyrighted, 2018. All rights are reserved. The original manufacturer reserves the right to make improvements to the products described in this manual at any time without notice.

No part of this manual may be reproduced, copied, translated, or transmitted in any form or by any means without the prior written permission of the original manufacturer. Information provided in this manual is intended to be accurate and reliable. However, the original manufacturer assumes no responsibility for its use, or for any infringements upon the rights of third parties that may result from its use. The material in this document is for product information only and is subject to change without notice. While reasonable efforts have been made in the preparation of this document to assure its accuracy, the original manufacturer assumes no liabilities resulting from errors or omissions in this document, or from the use of the information contained herein.

The original manufacturer reserves the right to make changes in the product design without notice to its users.

Acknowledgments

All other products' name or trademarks are properties of their respective owners.

- AMI is a trademark of American Megatrends Inc.
- Intel®, Core™ are trademarks of Intel® Corporation.
- Microsoft Windows® is a registered trademark of Microsoft Corp.
- IBM, PC/AT, PS/2, and VGA are trademarks of International Business Machines Corporation.

The original manufacturer reserves the right to make changes in the product design without notice to its users.

All other product names or trademarks are properties of their respective owners.

Contents

Chapter 1	Product overview	
1.1	Package contents.....	1-1
1.2	Features	1-1
1.3	Specifications.....	1-2
Chapter 2	Motherboard information	
2.1	Before you proceed	2-1
2.2	Motherboard layout.....	2-2
2.3	Screw size.....	2-4
	2.3.1 Component side.....	2-4
	2.3.2 Solder side	2-5
2.4	Central Processing Unit (CPU)	2-6
2.5	System memory	2-6
2.6	Jumpers	2-7
2.7	Connectors	2-10
	2.7.1 Rear panel connectors.....	2-10
	2.7.2 Internal connectors	2-12
Chapter 3	BIOS setup	
3.1	BIOS setup.....	3-1
3.2	Main menu	3-3
	3.2.1 System Date [Day MM/DD/YYYY]	3-3
	3.2.2 System Time [HH:MM:SS].....	3-3
3.3	Advanced menu	3-4
	Case Open Warning [Disabled].....	3-4
	3.3.1 CPU Configuration	3-4
	3.3.2 SATA Configuration	3-5
	3.3.3 USB Configuration	3-5
	3.3.4 Hardware Monitor	3-5
	3.3.5 SIO Configuration	3-8
	3.3.6 Power Management.....	3-9
	3.3.7 Digital IO Port Configuration	3-9
3.4	Chipset menu	3-10
	3.4.1 North Bridge.....	3-10
	3.4.2 South Bridge	3-11
3.5	Security menu	3-12

3.6 Boot menu 3-14
 3.6.1 Boot Configuration 3-14
 3.6.2 Boot Option Priorities 3-14
3.7 Exit menu 3-15

Appendix
Notices A-1

Chapter 1

Product overview

1.1 Package contents

Check your industrial motherboard package for the following items.

- 1 x Industrial Motherboard
- 1 x SATA cable
- 1 x SATA power cable
- 1 x I/O shield
- 1 x Support DVD



NOTE: If any of the above items is damaged or missing, contact your distributor or sales representative immediately.

1.2 Features

- Intel® Celeron® N3060 Dual Core 1.60 GHz/2.48 GHz(burst mode)
- DDR3L 1600/1333MHz SO-DIMM x1, up to 8GB, flat type non-ECC, unbuffered memory
- Three independent Display: VGA + LVDS + DVI-D
- Realtek PCIe Gb LAN 8111G x 2
- SATA 3Gb/s x 2, USB2.0 x 7, COM x5
- Full-size Mini Card (PCIe + USB) x 1, PCIe 2.0 [x1] x 1, M.2 M-Key x1

1.3 Specifications

SYSTEM	
CPU	Intel® Celeron® N3060 Dual Core 1.60 GHz/2.48 GHz(burst mode)
Memory	1 x SO-DIMM, max. 8GB , DDR3L 1600MHz,non-ECC, un-buffered memory, flat type
Graphics	Intel® HD Graphics
I/O Chipset	NCT6116D
LAN	2 x Realtek PCIe Gb LAN 8111G
Audio	Realtek® ALC3236-VB2-CG audio CODEC
Expansion slot	1 x M.2 M key (2242/2280) for SATA (default:2280) 1 x PCIe 2.0 [x1] 1 x Full-size Mini Card(PCle +USB)
BIOS	64Mbit Flash ROM, AMI BIOS
H/W Status Monitor	Temperature Monitor on CPU/System Voltage Monitor on Vcore/5V/3.3V/12V Fan Monitor on Chassis
Watchdog Timer	1~255 step by software program
Smart Fan Control	Chassis Fan (fanless)
Wake on LAN/PXE	Yes (WOL / PXE)
Power State	S3, S4, S5
Graphics	
Graphics Chipset	Intel® HD Graphics
Graphics Multi-Display	VGA + VDS + DVI-D
Resolution	VGA: Up to 1920 x 1200 @60 Hz LVDS: Up to 1920 x 1200 @60Hz, Daul Channel 18/24 bit (via PS8625) DVI-D: Up to 1920 x 1200 @60 Hz
Backlight Control	Voltage / PWM, use HW control
ENVIRONMENT, POWER, & ME	
Battery	Lithium battery
Power Requirement	12V DC (Lockable DC connector at back panel and Onboard 4pin 12V Power connector)
Operating Temperature	32°F~140°F (0°C~60°C)
Operating Humidity	0% ~ 90%RH, non-condensing
EMI	CE, FCC Class A
Form factor	Mini-ITX form factor: 6.7 in. x 6.7 in. (17.0 cm x 17.0 cm)
Weight	1.1 lb (0.5 Kg)

(continued on the next page)

PLACEMENT	
Back panel I/O ports	1 x 12 VDC port (lockable jack) 2 x COM (RS232, RS232/422/485 (COM2)) 1 x VGA + 1 x DVI-D 2 x USB 3.0 + LAN (RJ45) 2 x USB 3.0 + LAN (RJ45) 1 x Line out & Mic-in & Line-in
Internal I/O connectors	1 x PCIe 2.0 [x1] slot 1 x Full Size Mini Card slot 1 x M.2 M key (2242/2280) for SATA (default:2280) 1 x P/S2 header 1 x SATA 6Gb/s connectors 1 x SATA power connector 2 x USB 2.0 header support additional 3 USB ports (2 x 2*5PIN, p=2.00mm) 1 x Chassis Fan connector 3 x boxer header for COM (RS-232) 1 x DIO (4in/4out) 1 x 40-pin LVDS connector 1 x LVDS 3V /5V jumper 1 x LCD DC / PWM mode jumper 1 x LCD backlight connector (inverter) 1 x LCD backlight 12V /5V jumper 1 x Speaker (2W) 1 x 2*2 PIN DCIN 12V AUX Power Connector 1 x Front Panel connector 1 x AT/ATX mode select jumper 1 x CMOS jumper
OTHERS	
OS Support	Windows® 7 32 / 64bit Windows® 8.1 64bit Windows® 10 64bit Linux Fedora



NOTE: Specifications are subject to change without notice.

Chapter 2

Motherboard information

2.1 Before you proceed

Take note of the following precautions before you install motherboard components or change any motherboard settings.



CAUTION!

- Unplug the power cord from the wall socket before touching any component.
 - Before handling components, use a grounded wrist strap or touch a safely grounded object or a metal object, such as the power supply case, to avoid damaging them due to static electricity.
 - Hold components by the edges to avoid touching the ICs on them.
 - Whenever you uninstall any component, place it on a grounded antistatic pad or in the bag that came with the component.
 - Before you install or remove any component, ensure that the ATX power supply is switched off or the power cord is detached from the power supply. Failure to do so may cause severe damage to the motherboard, peripherals, or components.
-

Standby Power LED

The motherboard comes with a standby power LED that lights up to indicate that the system is ON, in sleep mode, or in soft-off mode. This is a reminder that you should shut down the system and unplug the power cable before removing or plugging in any motherboard component. The illustration below shows the location of the onboard LED.

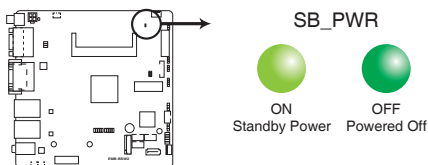

EMB-BSW2 Onboard LED

2.2 Motherboard layout



NOTE: Place four screws into the holes indicated by circles with the motherboard to the chassis.



CAUTION! Do not overtighten the screws! Doing so can damage the motherboard.

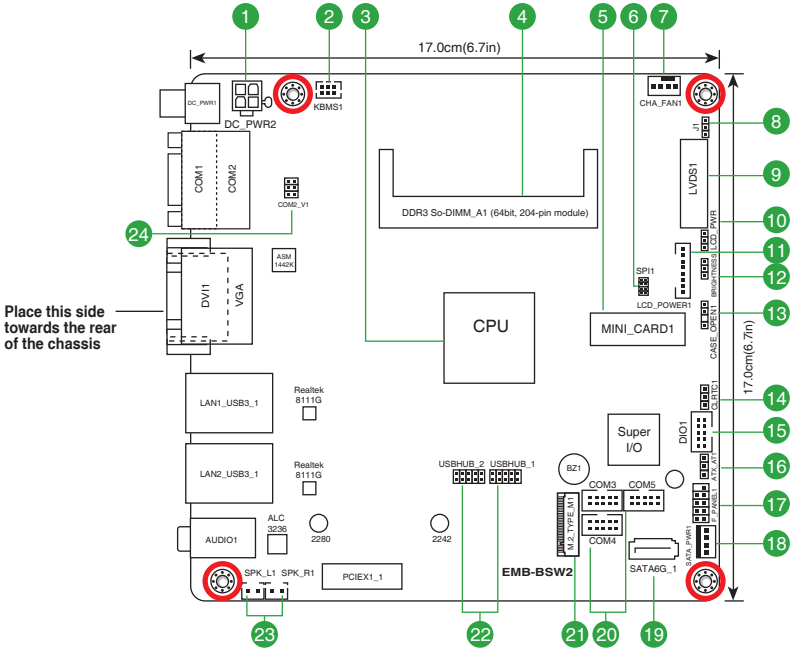

Connectors/Jumpers/Slots		Page
1.	DC-In 4P power connector (4-pin DC_PWR2)	2-12
2.	PS/2 keyboard/mouse connector (10-pin KBMS2)	2-14
3.	Integrated Intel® Braswell™ processor	2-6
4.	DDR3 204-pin SO-DIMM slots	2-6
5.	Minicard connector (MINI_CARD1)	2-15
6.	BIOS Programmable connector (8-pin SPI_1)	2-16
7.	Chassis fan connector (4-pin CHA_FAN1)	2-12
8.	LVDS1 panel voltage selection jumper (3 pin J1)	2-7
9.	LVDS connectors (30-pin LVDS1)	2-13
10.	LCD inverter power setting jumper (3-pin LCD_PWR)	2-9
11.	LCD panel power connector (5-pin LCD_POWER1)	2-18
12.	BRIGHTNESS selection jumper (3-pin BRIGHTNESS)	2-9
13.	Chassis intrusion connector (4-1 pin CASE_OPEN1)	2-8
14.	Clear RTC RAM (3-pin CLRTC)	2-7
15.	Digital I/O connector (10-pin DIO1)	2-16
16.	AT/ATX mode jumper (3-pin ATX_AT1)	2-8
17.	System panel connector (10-pin F_PANEL)	2-14
18.	SATA power connector (4-pin SATA_PWR1)	2-15
19.	Serial ATA 6Gb/s connector (7-pin SATA6G_1)	2-15
20.	Serial port connectors (10-pin COM3/4/5)	2-13
21.	M.2 M-Key slot	2-17
22.	USB 2.0 connectors (10-1 pin USBHUB1, USBHUB2)	2-17
23.	Internal audio connectors (2-pin SPK_L1, SPK_R1)	2-16
24.	COM2 Ring/+5V/+12V selection (COM2_V)	2-9

2.3 Screw size

2.3.1 Component side

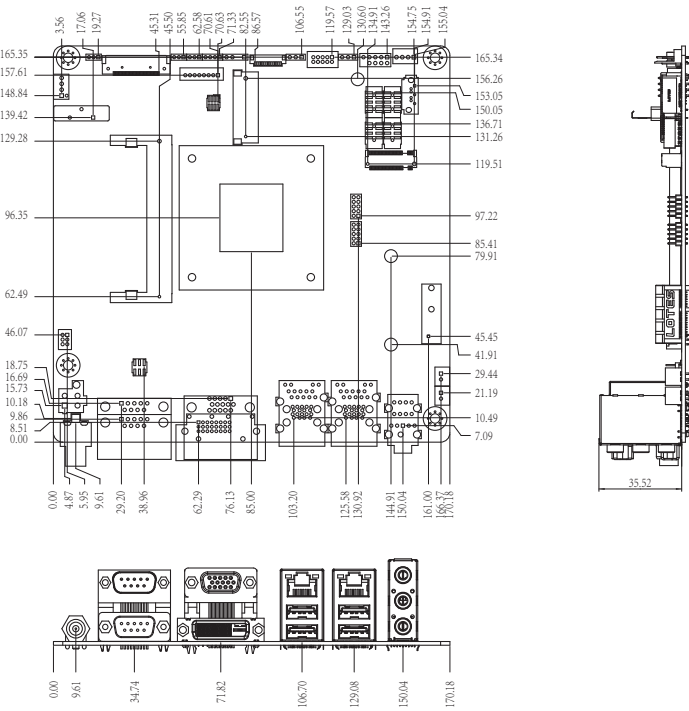

2.3.2 Solder side

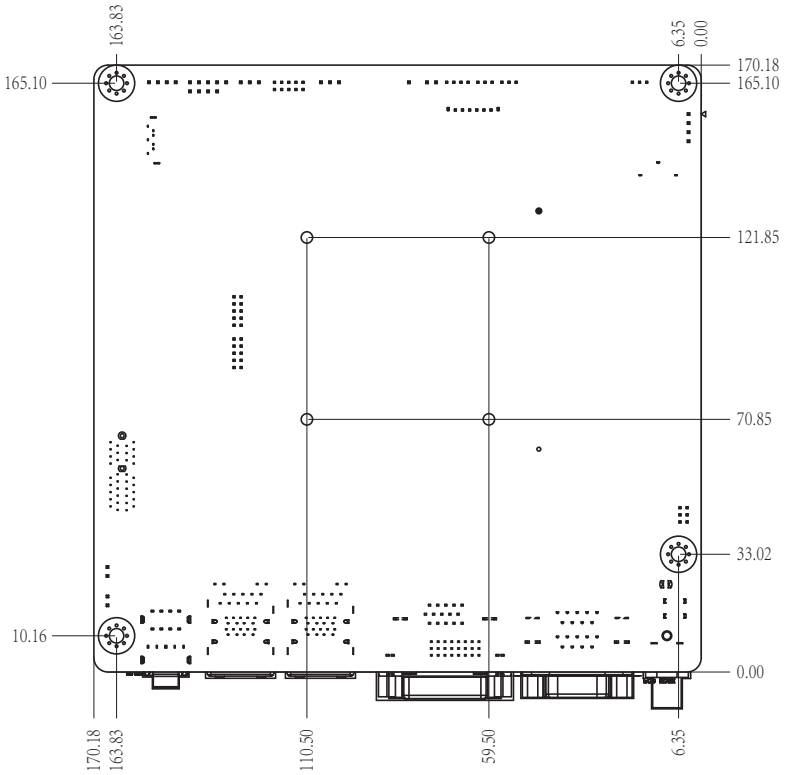

2.4 Central Processing Unit (CPU)

This motherboard comes with an integrated Intel® Celeron® processor N3060.

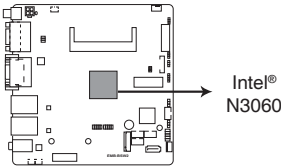

EMB-BSW2 CPU on board

2.5 System memory

This motherboard comes with one Double Data Rate 3 Low Voltage (DDR3L) Small Outline Dual Inline Memory Modules (SO-DIMM) sockets. The figure illustrates the location of the DDR3L DIMM sockets:

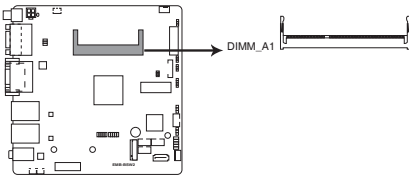

**EMB-BSW2 204-pin
DDR3 So-DIMM socket**

To install a DIMM

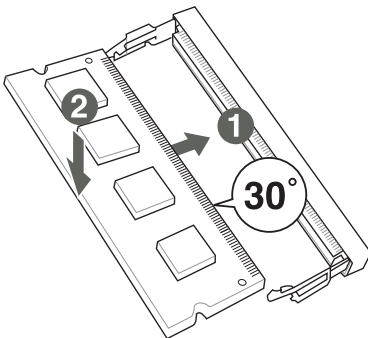

To remove a DIMM

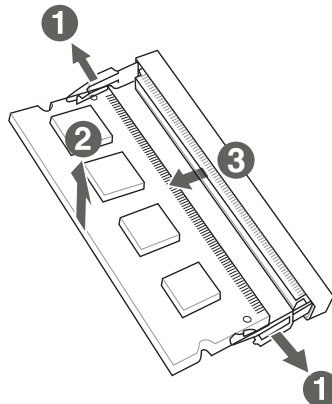

2.6 Jumpers

1. Clear RTC RAM (CLRTC1)

This jumper allows you to clear the Real Time Clock (RTC) RAM in CMOS. You can clear the CMOS memory of date, time, and system setup parameters by erasing the CMOS RTC RAM data. The onboard button cell battery powers the RAM data in CMOS, which include system setup information such as system passwords.

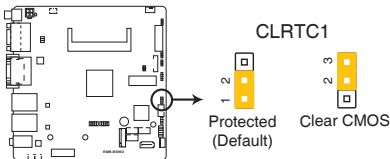

EMB-BSW2 Clear RTC RAM

To erase the RTC RAM:

1. Turn OFF the computer and unplug the power cord.
2. Move the jumper cap from pins 1-2 (default) to pins 2-3. Keep the cap on pins 2-3 for about 5~10 seconds, then move the cap back to pins 1-2.
3. Plug the power cord and turn ON the computer.
4. Hold down the key during the boot process and enter BIOS setup to reenter data.



CAUTION! Except when clearing the RTC RAM, never remove the cap on CLRTC jumper default position. Removing the cap will cause system boot failure!



NOTE: If the steps above do not help, remove the onboard battery and move the jumper again to clear the CMOS RTC RAM data. After clearing the CMOS, reinstall the battery.

2. LVDS1 panel voltage selection jumper (3-pin J1)

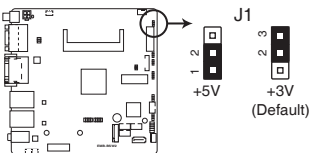

EMB-BSW2 LVDS1 Panel Voltage selection

3. AT/ATX mode selection (3-pin ATX_AT1)

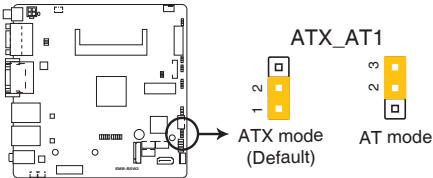

EMB-BSW2 ATMODE setting

	Pins
AT mode	1-2
ATX mode (Default)	2-3

4. Chassis intrusion jumper (4-1 pin CASE_OPEN1)

This connector is for a chassis-mounted intrusion detection sensor or switch. Connect one end of the chassis intrusion sensor or switch cable to this connector. The chassis intrusion sensor or switch sends a high-level signal to this connector when a chassis component is removed or replaced. The signal is then generated as a chassis intrusion event.

Move the jumper cap to pins 1-2 when you intend to use the chassis intrusion detection feature.

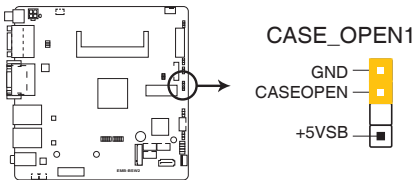

EMB-BSW2 CASE OPEN connector

Pins	
1-2	Enables the chassis intrusion detection feature
3-4	Disables the chassis intrusion detection feature (Default)

5. COM2 Ring/+5V/+12V selection jumper (6-pin COM2_V1)

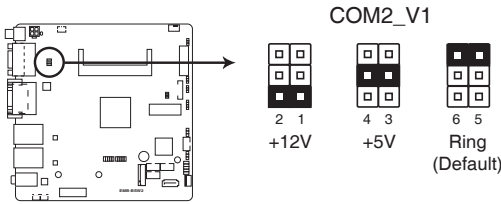

EMB-BSW2 COM2 Ring/+5V/+12V selection

Setting	Pins
+12V	1-2
+5V	3-4
Ring (Default)	5-6

6. Inverter1 Voltage selection (3-pin LCD_PWR)

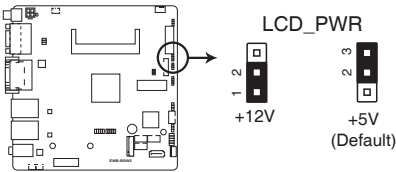

EMB-BSW2 Inverter1 Voltage selection

Pins	
1-2	+12V
2-3	+5V (Default)

7. BRIGHTNESS selection jumper (3-pin BRIGHTNESS)

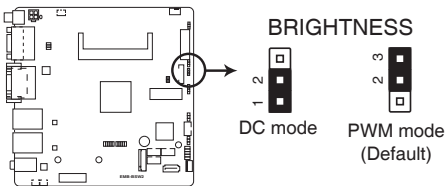

EMB-BSW2 BRIGHTNESS selection jumper

Pins	
1-2	DC mode
2-3	PWM mode (Default)

2.7 Connectors

2.7.1 Rear panel connectors

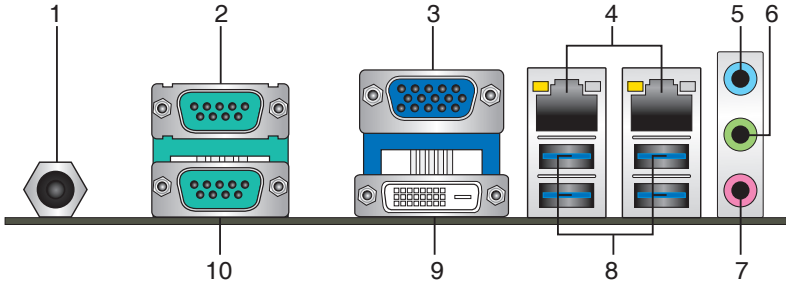

- DC power port.** This port connects to a DC power adapter.
- COM2 port.** This 9-pin COM port is for pointing devices or other serial devices.

Int. Serial Port Connector for (COM2 / RS232)

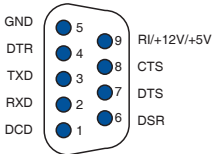

Int. Serial Port Connector for (COM2 / RS485)

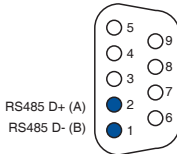

Int. Serial Port Connector for (COM2 / RS422)

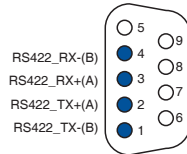

- Video Graphics Adapter (VGA) port.** This 15-pin port is for a VGA monitor or other VGA-compatible devices.



NOTE: Disable LVDS support when using only the VGA port. Refer to the section on System Agent (SA) Configuration in Chapter 3 for details.

- LAN (RJ-45) ports.** These ports allow Gigabit connection to a Local Area Network (LAN) through a network hub. Refer to the table below for the LAN port LED indications.

LAN port LED indications

ACT/LINK LED		SPEED LED	
Status	Description	Status	Description
OFF	No link	OFF	10 Mbps connection
ORANGE	Linked	ORANGE	100 Mbps connection
BLINKING	Data activity	GREEN	1 Gbps connection

Activity Link LED Speed LED

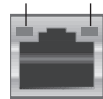

LAN port

5. **Line In port (light blue).** This port connects the tape, CD, DVD player, or other audio sources.
6. **Line Out port (lime).** This port connects to a headphone or a speaker. In a 4.1-channel and 5.1-channel configurations, the function of this port becomes Front Speaker Out.
7. **Microphone port (pink).** This port connects to a microphone.



NOTE: Refer to the audio configuration table below for the function of the audio ports in the 2.1, 4.1 or 5.1-channel configuration.

Audio 2.1, 4.1, or 5.1-channel configuration

Port	Headset 2.1-channel	4.1-channel	5.1-channel
Light Blue	Line In	Rear Speaker Out	Rear Speaker Out
Lime	Line Out	Front Speaker Out	Front Speaker Out
Pink	Mic In	Mic In	Bass/Center

8. **USB 3.0 ports.** These 9-pin Universal Serial Bus (USB) ports connect to USB 3.0/2.0 devices.



NOTES:

- DO NOT connect a keyboard / mouse to any USB 3.0 port when installing Windows® operating system.
- Due to USB 3.0 controller limitation, USB 3.0 devices can only be used under Windows® OS environment and after the USB 3.0 driver installation.
- We strongly recommend that you connect USB 3.0 devices to USB 3.0 ports for faster and better performance for your USB 3.0 devices.

9. **DVI-D port.** This port is for any DVI-D compatible device.



DVI-D can not be converted to output from RGB Signal to CRT and is not compatible with DVI-I.

10. **COM1 port.** This 9-pin COM port is for pointing devices or other serial devices.

Int. Serial Port Connector for
(COM1 / RS232)

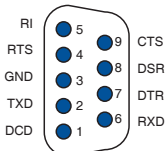

2.7.2 Internal connectors

1. Chassis fan connectors (4-pin FAN1)

Connect the fan cable to the fan connector on the motherboard, ensuring that the black wire of the cable matches the ground pin of the connector.

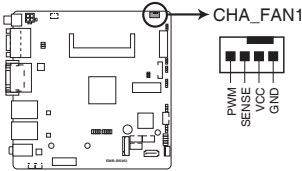

EMB-BSW2 Fan connector



CAUTION! Do not forget to connect the fan cable to the fan connector. Insufficient air flow inside the system may damage the motherboard components. This is not a jumper! Do not place a jumper cap on the fan connector!

2. DC-In 4P power connector (4-pin DC_PWR2)

This connector is for the power supply plug. The power supply plug is designed to fit this connector in only one orientation. Find the proper orientation and push down firmly until the connector completely fit.

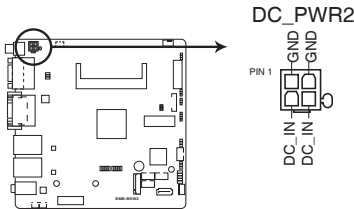

**EMB-BSW2 1 x 4 PIN (2x2)
internal power connector**

3. Serial port connectors (10 pin COM3/4/5)

These connectors are for serial (COM) ports. Connect the serial port module cable to this connector, then install the module to a slot opening at the back of the system chassis.

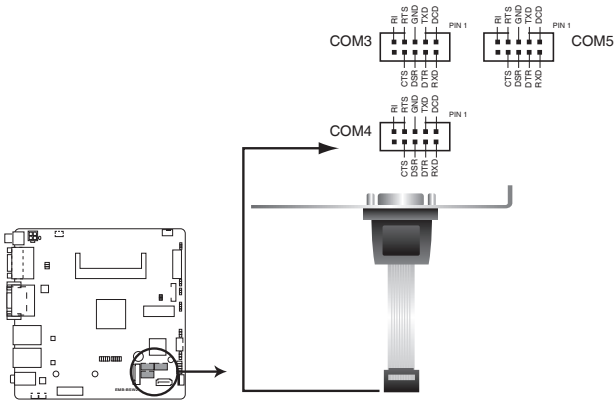

EMB-BSW2 Serial port connectors

4. LVDS connector (40-pin LVDS1)

This connector is for an LCD monitor that supports Low-Voltage Differential Signaling (LVDS) interface.

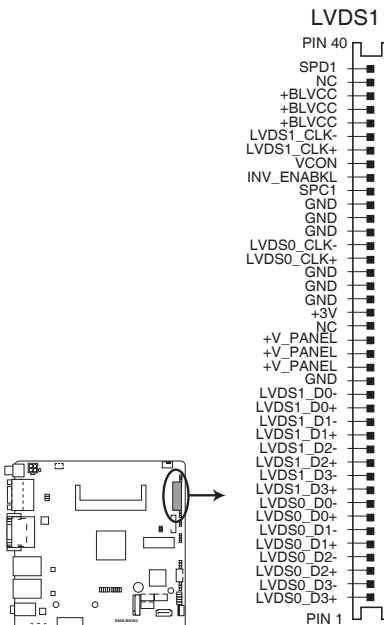

EMB-BSW2 LVDS Panel Signal connector

5. System panel connector (10-1 pin F_PANEL)

This connector supports several chassis-mounted functions.

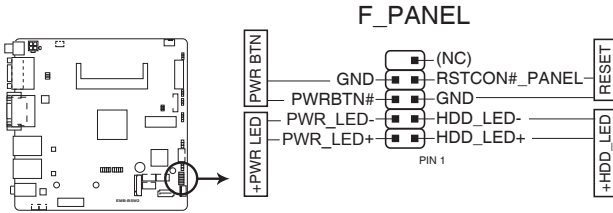

EMB-BSW2 System panel connector

- **System power LED (2-pin PWR_LED)**

This 2-pin connector is for the system power LED. Connect the chassis power LED cable to this connector. The system power LED lights up when you turn on the system power, and blinks when the system is in sleep mode.

- **Hard disk drive activity LED (2-pin HDD_LED)**

This 2-pin connector is for the HDD Activity LED. Connect the HDD Activity LED cable to this connector. The HDD LED lights up or flashes when data is read from or written to the HDD.

- **ATX power button/soft-off button (2-pin PWR_BTN)**

This 2-pin connector is for the system power button.

- **Reset button (2-pin RESET)**

This 2-pin connector is for the chassis-mounted reset button for system reboot without turning off the system power.

6. PS/2 keyboard/mouse connector (6-pin KBMS2)

This connector is for an IBM PS/2-compatible keyboard or mouse.

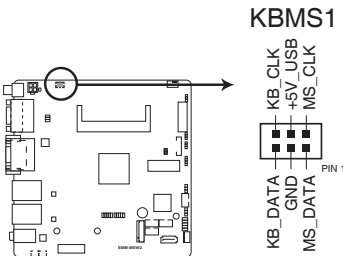

EMB-BSW2 Series PS/2 keyboard/mouse connector

7. Serial ATA 6.0Gb/s connectors (7-pin SATA6G_1)

These connectors connect to Serial ATA 6.0 Gb/s hard disk drives and optical drives via Serial ATA 6.0 Gb/s signal cables.

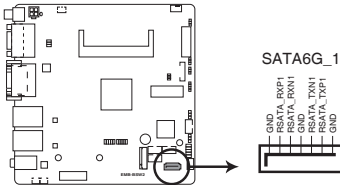

EMB-BSW2 SATA 6.0Gb/s connector

8. SATA power connector (4-pin SATA_PWR1)

This connector is for the SATA power cable. The power cable plug is designed to fit this connector in only one orientation. Find the proper orientation and push down firmly until the connector completely fit.

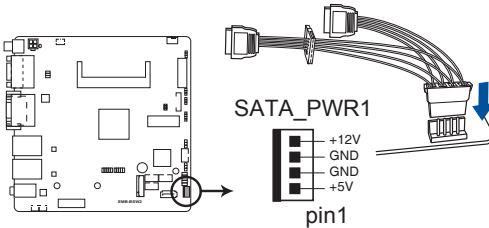

EMB-BSW2 SATA POWER connector

9. Minicard connector

Use this connector to connect a Minicard reader.

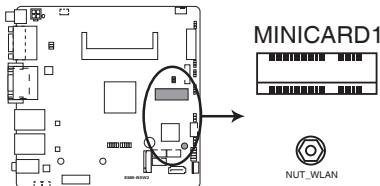

EMB-BSW2 MINICARD connector

10. BIOS programmable connector (8-pin SPI)

Use this connector to flash the BIOS ROM.

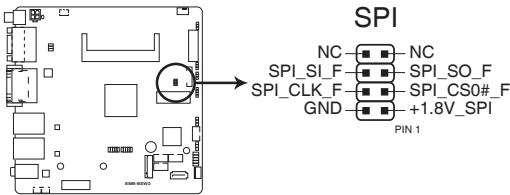

EMB-BSW2 flase Programmable connector for Aeon

11. Digital I/O connector (10-pin DIO1)

This connector includes 8 I/O lines (In/Out programmable). All of the Digital I/O lines are programmable and each I/O pin can be individually programmed to support various devices.

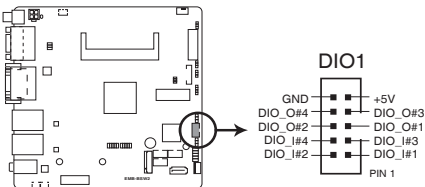

EMB-BSW2 Digital I/O connector



NOTE: To configure the I/O pins in BIOS, go to the **Advanced** tab > **Digital IO Port Configuration** > **DIO Port 1-8**. See section 3.3.8 **Digital IO Port Configuration** for details.

12. Internal audio connectors (2-pin SPK_L1, SPK_R1)

These 2-pin connectors are for audio connections. Connect the audio cable to these connectors for Line Out and Rear Speaker Out functions.

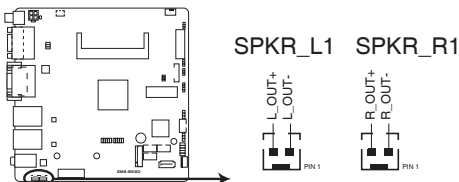

EMB-BSW2 INT_SPKR connectors

13. USB 2.0 connectors (10-1 pin USBHUB1, USBHUB2)

These connectors are for USB 2.0 ports. Connect the USB module cable to any of these connectors, then install the module to a slot opening at the back of the system chassis. These USB connectors comply with USB 2.0 specification that supports up to 480 Mbps connection speed.

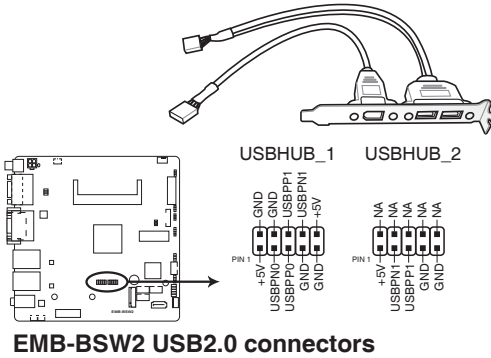

CAUTION! Never connect a 1394 cable to the USB connector. Doing so will damage the motherboard.

14. M.2 M-Key slot

This socket allows you to install an M.2 (NGFF) SSD module.

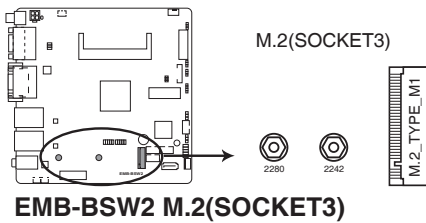

NOTE: The M.2 SSD module is purchased separately.

15. LCD panel power connector (5-pin LCD_POWER)

Connect the LCD panel power cable to this connector.

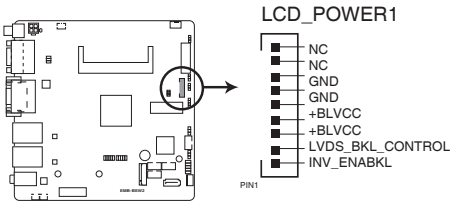

EMB-BSW2 Inverter connector

Chapter 3

BIOS setup

3.1 BIOS setup

Use the BIOS Setup to update the BIOS or configure settings. The BIOS screens include navigation keys and help to guide you in using the BIOS Setup program.

Entering BIOS Setup at startup

To enter BIOS Setup at startup:

Press <Delete> during the Power-On Self Test (POST). If you do not press <Delete>, POST continues with its routine.

Entering BIOS Setup after POST

To enter BIOS Setup after POST:

- Press <Ctrl>+<Alt>+ simultaneously.
- Press the reset button on the system chassis.
- Press the power button to turn the system off then back on. Do this option only if you failed to enter BIOS Setup using the first two options.



NOTE: Using the power button, reset button, or the <Ctrl>+<Alt>+ keys to reboot a running operating system can cause damage to your data or system. Always shut down the system properly from the operating system.



IMPORTANT:

- The default BIOS settings for this motherboard apply to most working conditions and ensures optimal performance. If the system becomes unstable after changing any BIOS settings, load the default settings to regain system stability. Select the option **Restore Defaults** under the Save & Exit Menu. See section 3.7 **Save & Exit Menu**.
 - The BIOS setup screens shown in this section are for reference purposes only, and may not exactly match what you see on your screen.
 - If the system fails to boot after changing any BIOS setting, try to clear the CMOS and reset the motherboard to the default value. See section 2.6 **Jumpers** for information on how to erase the RTC RAM.
-

BIOS menu screen

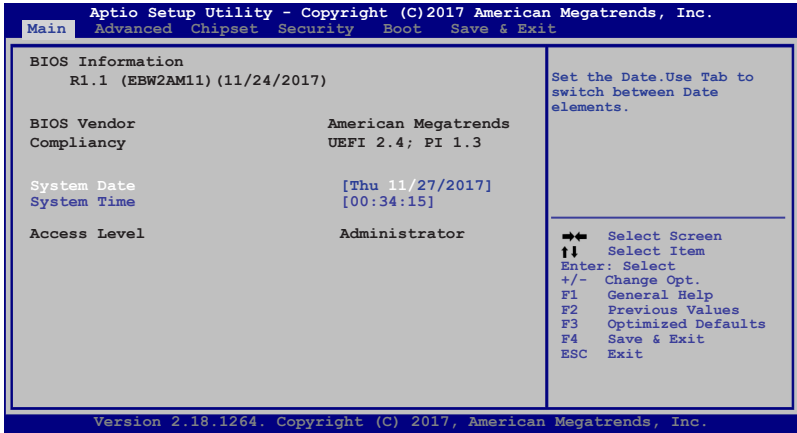

Menu bar

The menu bar on top of the screen has the following main items:

- Main** For changing the basic system configuration.
- Advanced** For changing the advanced system settings.
- Chipset** For viewing and changing chipset settings.
- Boot** For changing the system boot configuration.
- Security** For viewing and changing security Information.
- Save & Exit** For selecting the save & exit options and loading default settings.

To select an item on the menu bar, press the right or left arrow key on the keyboard until the desired item is highlighted.

3.2 Main menu

The Main menu provides you an overview of the basic system information, and allows you to set the system date and time.

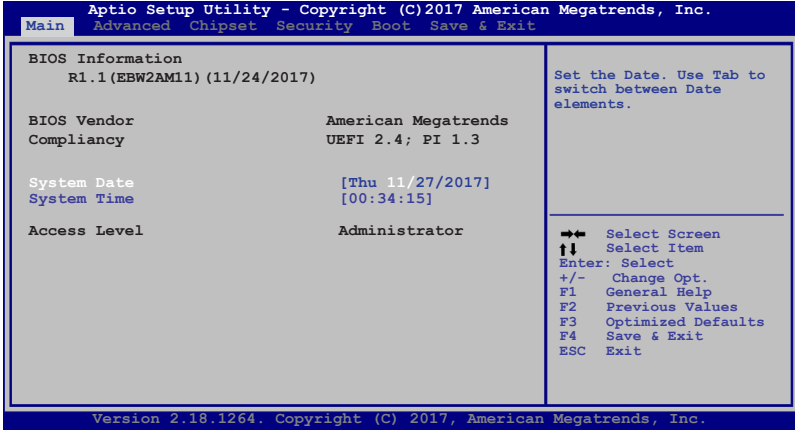

3.2.1 System Date [Day MM/DD/YYYY]

Allows you to set the system date.

3.2.2 System Time [HH:MM:SS]

Allows you to set the system time.

3.3 Advanced menu

The Advanced menu items allow you to change the settings for the CPU and other system devices.



Be cautious when changing the settings of the Advanced menu items. Incorrect field values can cause the system to malfunction.

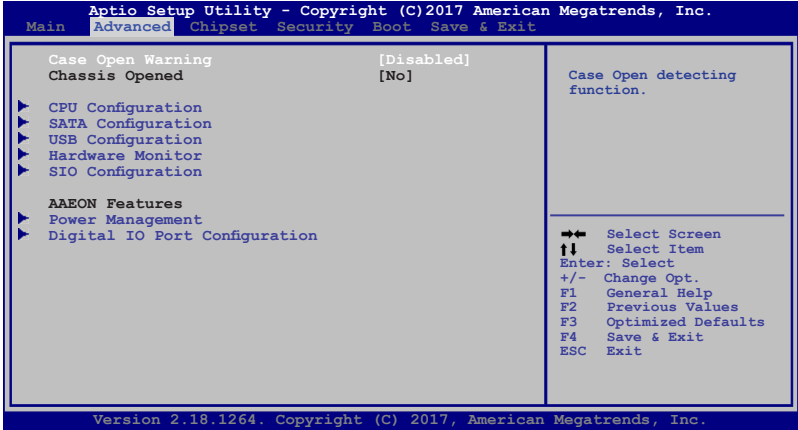

Case Open Warning [Disabled]

This item allows you to enable or disable the case open warning function. Configuration options: [Enabled] [Disabled] [Clear]

Chassis Opened [No]

This item shows whether the chassis is opened or not.

3.3.1 CPU Configuration

The items in this menu show the CPU-related information that the BIOS automatically detects.



The items shown in the submenu may be different due to the CPU installed.

Intel Virtualization Technology [Enabled]

[Enabled] Allows a hardware platform to run multiple operating systems separately and simultaneously, enabling one system to virtually function as several systems.

[Disabled] Disables this function.

3.3.2 SATA Configuration

While entering Setup, the BIOS automatically detects the presence of SATA devices. The SATA Port items show **Not Present** if no SATA device is installed to the corresponding SATA port.

3.3.3 USB Configuration

The items in this menu allow you to change the USB-related features.



The USB Devices item shows the auto-detected values. If no USB device is detected, the item shows **None**.

Legacy USB Support [Enabled]

- [Enabled] Enables the support for USB devices on legacy operating systems (OS).
- [Disabled] The USB devices can be used only for the BIOS setup program.
- [Auto] Allows the system to detect the presence of USB devices at startup. If detected, the USB controller legacy mode is enabled. If no USB device is detected, the legacy USB support is disabled.

3.3.4 Hardware Monitor

Smart Fan Configuration

CPU Smart Fan Control [Disabled]

Enable or disable the CPU Smart Fan control function. Configuration options: [Enabled] [Disabled]



The following items appear only when you set CPU Smart Fan Control to [Enabled].

Fan Control Mode [Manual Mode]

Configuration options: [Manual Mode] [Thermal Cruise Mode] [Speed Cruise Mode] [SMART FAN IV Mode]



The following item appears only when you set Fan Control Mode to [Manual Mode].

PWM/DC Voltage Output [255]

Allows you set the expected PWM/DC voltage output value. The values range from 0 to 255.



The following items appear only when you set Fan Control Mode to [Thermal Cruise Mode].

Temperature Source [CPU (External)]

Allows you to select the temperature source of fan control. Configuration options: [System] [CPU (External)].

Target Temperature [50]

Allows you to set the target temperature of fan control. The values range from 0 to 127.

Tolerance of Temperature [0]

Allows you to set the tolerance of target temperature. The values range from 0 to 7.

Fan Out Start-Up Value [127]

Allows you to set the fan-out start-up value. The values range from 0 to 255.

Fan Stop Duty [Down to 0]

Allows you to select the fan stop duty. Configuration options: [Down to 0] [To Fan Out Stop Value]

Fan Out Stop Value [100]

The fan out value decreases to this value if the temperature stays below the lowest temperature limit. The values range from 0 to 255.

Fan Out Stop Time [60]

Set the time that the fan out value to fall from the stop value to 0. The values range from 0 to 255.

Critical Temperature [75]

Set the time that Fan Out takes to decrease its value by one step. The values range from 0 to 255.

Fan Out Step Up Time [10]

Set the time that Fan out takes to increase its value by one step. The values range from 0 to 255 at an interval of 0.1 second.

Fan Out Step Down Time [10]

Set the time that Fan Out takes to decrease its value by one step. The values range from 0 to 255 at an interval of 0.1 second.



The following items appear only when you set Fan Control Mode to [Speed Cruise Mode].

Target Speed [0]

Allows you to set the target speed of fan control. The values range from 0 to 4096.

Speed Tolerance [2]

Allows you to set the tolerance of fan's target speed. The values range from 0 to 64.

Fan Out Step Up Time [10]

Set the time that Fan out takes to increase its value by one step. The values range from 0 to 255 at an interval of 0.1 second.

Fan Out Step Down Time [10]

Set the time that Fan Out takes to decrease its value by one step. The values range from 0 to 255 at an interval of 0.1 second.



The following items appear only when you set Fan Control Mode to [SMART FAN IV Mode].

Temperature Source [CPU (External)]

Allows you to select the temperature source of fan control. Configuration options: [System] [CPU (External)].

Close-Loop Fan Mode [Disabled]

Allows you to enable or disable the Close Loop fan control RPM mode of Smart Fan IV. Configuration options: [Enabled] [Disabled].

Temperature 1 [40] / Temperature 2 [50] / Temperature 3 [60] / Temperature 4 [70]

Determines the temperature value for the Smart Fan IV mode.

Fan PWM 1 [150] / Fan PWM 2 [170] / Fan PWM 3 [200] / Fan PWM 4 [220]

Determines the amount of Fan PWM value for the Smart Fan IV mode.

Tolerance of Temperature [0]

Input value range: [0~7]

Critical Temperature [75]

Input value range: [0~255]

Critical Temp Tolerance [0]

Input value range: [0~7]

Fan Out Step Up Time [10]

Determines the amount of time Fan Out takes to increase its value by one step. Input value range: [0~255]

Fan Out Step Down Time [10]

Determines the amount of time Fan Out takes to decrease its value by one step in intervals of 0.1 seconds. Input value range: [0~255]

3.3.5 SIO Configuration

[*Active*] Serial Port 1~5

The sub-items in this menu allow you to set the serial port configuration.

Use This Device [Enabled]

Allows you to enable or disable the serial port (COM). Configuration options: [Enabled] [Disabled]

Possible [Use Automatic Settings]

Allows you to select the Serial Port base address. Configuration options: [Use Automatic Settings] [IO=3F8h; IRQ=4] [IO=2F8h; IRQ=3;]

[*Active*] Serial Port 2

The sub-items in this menu allow you to set the serial port configuration.

Use This Device [Enabled]

Allows you to enable or disable the serial port (COM). Configuration options: [Enabled] [Disabled]

Possible [Use Automatic Settings]

Allows you to select the Serial Port base address. Configuration options: [Use Automatic Settings] [IO=2F8h; IRQ=3;] [IO=3F8h; IRQ=4]

Mode [RS232]

Allows you to select RS232, RS422 or RS455. Configuration options: [RS232] [RS422] [RS485]

[*Active*] Serial Port 3

The sub-items in this menu allow you to set the serial port configuration.

Use This Device [Enabled]

Allows you to enable or disable the serial port (COM). Configuration options: [Enabled] [Disabled]

Possible [Use Automatic Settings]

Allows you to select the Serial Port base address. Configuration options: [Use Automatic Settings] [IO=2F0h; IRQ=6;] [IO=2E0h; IRQ=6]

[*Active*] Serial Port 4

The sub-items in this menu allow you to set the serial port configuration.

Use This Device [Enabled]

Allows you to enable or disable the serial port (COM). Configuration options: [Enabled] [Disabled]

Possible [Use Automatic Settings]

Allows you to select the Serial Port base address. Configuration options: [Use Automatic Settings] [IO=2E8h; IRQ=7;] [IO=3E8h; IRQ=7]

[*Active*] Serial Port 5

The sub-items in this menu allow you to set the serial port configuration.

Use This Device [Enabled]

Allows you to enable or disable the serial port (COM). Configuration options: [Enabled] [Disabled]

Possible [Use Automatic Settings]

Allows you to select the Serial Port base address. Configuration options: [Use Automatic Settings] [IO=2D0h; IRQ=10:] [IO=3C0h; IRQ=10]

3.3.6 Power Management

Restore AC Power Loss [Last State]

- | | |
|--------------|--|
| [Always On] | The system goes into on state after an AC power loss. |
| [Always Off] | The system goes into off state after an AC power loss. |
| [Last State] | The system goes into either off or on state, whatever the system state was before the AC power loss. |

RTC wake system from S5 [Disabled]

Allows you to enable or disable system wake up on alarm event. When you select [Fixed Time], the system will wake up on a specified time. When you select [Dynamic Time], the system will wake up on the current time. Configuration options: [Disabled] [Fixed Time] [Dynamic Time]

3.3.7 Digital IO Port Configuration

The items in this menu allow you to modify Digital IO settings.

DIO Port 1~4 [Output]

Set DIO data flow as Input or Output. Configuration options: [Input] [Output]

Output Level [High]

Configuration options: [High][Low]

DIO Port 5~8 [Input]

Set DIO data flow as Input or Output. Configuration options: [Input] [Output]

3.4 Chipset menu

The Chipset menu items allow you to change the settings for the chipset.



Be cautious when changing the settings of the Advanced menu items. Incorrect field values can cause the system to malfunction.

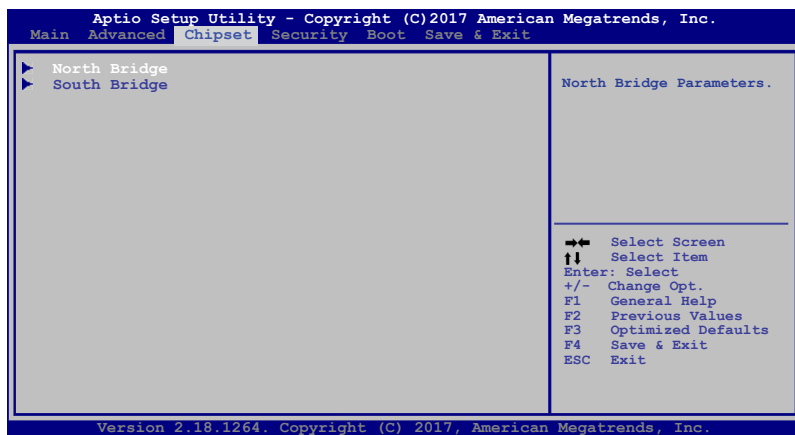

3.4.1 North Bridge

PMax TOLUD [2GB]

Allows you to select more useable memory on x86 OS. If you use external graphic card, set this option to 2GB. Configuration options: [2 GB] [2.25 GB] [2.5GB] [2.75GB] [3 GB]

Primary Display [Auto]

Allows you to select which of IGD/PCI graphics device should be the primary display. Configuration options: [Auto] [IGD] [PCIe]

Primary IGFX Boot Display [Auto]

Select the Video Device which will be activated during POST. Your selection does not take effect if you have installed an external graphics device. Secondary boot display selection will appear based on your selection. VGA modes can be supported only on the primary display. Configuration options: [Auto] [DVI] [LVDS] [VGA]

LVDS Panel Support [Enabled]

Enable or disable LVDS panel support. Configuration options: [Disabled] [Enabled]

LVDS Panel Type [1024x768]

Select the type of LCD panel used as display. Configuration options: [800x600] [1024x768] [1280x768] [1366x768] [1440x900] [1600x900] [1280x1024] [1400x1050] [1600x1200] [1680x1050] [1920x1080] [1920x1200]

LVDS Color Depth [24-bit]

Select the color depth of LCD panel used as display. Configuration options: [24-bit] [18-bit]

LVDS Channel Type [Single]

Select the channel type of LCD panel used as display. Configuration options: [Single] [Dual]

LVDS Brightness Type [Normal]

Select the brightness type of LCD panel used as display. Configuration options: [Normal] [Inverted]

LVDS Brightness Level [80%]

Select the brightness level of LCD panel used by display. Configuration options: [100%] [90%] [80%] [70%] ~ [20%] [10%] [0%]

3.4.2 South Bridge

Audio Controller [Enabled]

Configuration options: [Disabled] [Enabled]

Mini Card Lane Speed [Auto]

Configuration options: [Auto] [Gen 1] [Gen 2]

PCIe Slot Lane Speed [Auto]

Configuration options: [Auto] [Gen 1] [Gen 2]

3.5 Security menu

The Security menu items allow you to change the system security settings.



Administrator Password

If you have set an administrator password, we recommend that you enter the administrator password for accessing the system. Otherwise, you might be able to see or change only selected fields in the BIOS setup program.

To set an administrator password:



- If you have forgotten your BIOS password, erase the CMOS Real Time Clock (RTC) RAM to clear the BIOS password. See section **2.6 Jumpers** for information on how to erase the RTC RAM.
- The **Administrator** or **User Password** items on top of the screen show the default **Not Installed**. After you set a password, these items show **Installed**.

1. Select the **Administrator Password** item and press <Enter>.
2. From the **Create New Password** box, key in a password, then press <Enter>.
3. Confirm the password when prompted.

To change an administrator password:

1. Select the **Administrator Password** item and press <Enter>.
2. From the **Enter Current Password** box, key in the current password, then press <Enter>.
3. From the **Create New Password** box, key in a new password, then press <Enter>.

To clear the administrator password, follow the same steps as in changing an administrator password, but press <Enter> when prompted to create/confirm the password. After you clear the password, the **Administrator Password** item on top of the screen shows **Not Installed**.

User Password

If you have set a user password, you must enter the user password for accessing the system. The **User Password** item on top of the screen shows the default **Not Installed**. After you set a password, this item shows **Installed**.

To set a user password:

1. Select the **User Password** item and press <Enter>.
2. From the **Create New Password** box, key in a password, then press <Enter>.
3. Confirm the password when prompted.

To change a user password:

1. Select the **User Password** item and press <Enter>.
2. From the **Enter Current Password** box, key in the current password, then press <Enter>.
3. From the **Create New Password** box, key in a new password, then press <Enter>.
4. Confirm the password when prompted.

To clear the user password, follow the same steps as in changing a user password, but press <Enter> when prompted to create/confirm the password. After you clear the password, the **User Password** item on top of the screen shows **Not Installed**.

3.6 Boot menu

The Boot menu items allow you to change the system boot options.

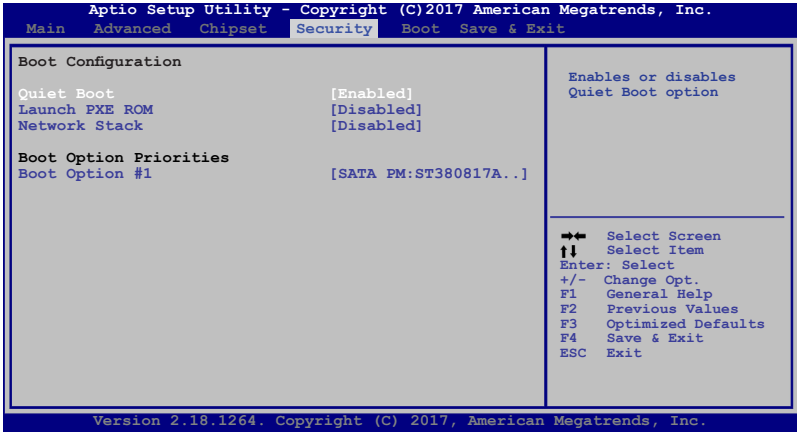

3.6.1 Boot Configuration

Quiet Boot [Enabled]

This item enables/disables Quiet Boot. Configuration options: [Disabled] [Enabled]

Launch PXE ROM [Disabled]

This item enables/disables the execution of UEFI and Legacy PXE OpROM. Configuration options: [Disabled] [Enabled]

Network Stack [Disabled]

This item enables/disables the network stack. Configuration options: [Disabled] [Enabled]

3.6.2 Boot Option Priorities

These items specify the boot device priority sequence from the available devices. The number of device items that appears on the screen depends on the number of devices installed in the system.



- To select the boot device during system startup, press <F7> during POST.
- To access Windows OS in Safe Mode, do any of the following:
 - Press <F5> during POST.
 - Press <F8> after POST.

3.7 Exit menu

The Save & Exit menu items allow you to load the optimal default values for the BIOS items, and save or discard your changes to the BIOS items.

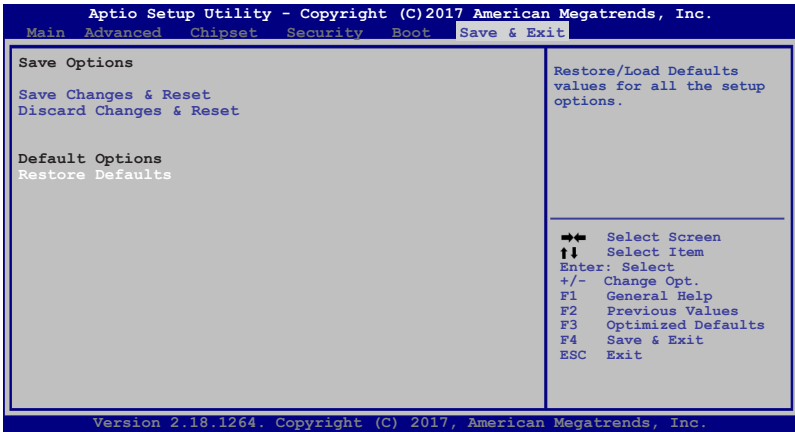

Save Changes & Reset

Once you are finished making your selections, choose this option from the Exit menu to ensure the values you selected are saved. When you select this option, a confirmation window appears. Select Yes to save changes and reset.

Discard Changes & Reset

This option allows you to reset the system without saving your changes. When you select this option, a confirmation window appears. Select Yes to discard changes and reset.

Restore Defaults

This option allows you to restore the default values for each of the parameters on the Setup menus. When you select this option or if you press <F3>, a confirmation window appears. Select Yes to load the default values.

Appendix

Notices

Federal Communications Commission Statement

This device complies with Part 15 of the FCC Rules. Operation is subject to the following two conditions:

- This device may not cause harmful interference.
- This device must accept any interference received including interference that may cause undesired operation.

This equipment has been tested and found to comply with the limits for a Class A digital device, pursuant to Part 15 of the FCC Rules. These limits are designed to provide reasonable protection against harmful interference in a residential installation. This equipment generates, uses and can radiate radio frequency energy and, if not installed and used in accordance with manufacturer's instructions, may cause harmful interference to radio communications. However, there is no guarantee that interference will not occur in a particular installation. If this equipment does cause harmful interference to radio or television reception, which can be determined by turning the equipment off and on, the user is encouraged to try to correct the interference by one or more of the following measures:

- Reorient or relocate the receiving antenna.
- Increase the separation between the equipment and receiver.
- Connect the equipment to an outlet on a circuit different from that to which the receiver is connected.
- Consult the dealer or an experienced radio/TV technician for help.



WARNING! The use of shielded cables for connection of the monitor to the graphics card is required to assure compliance with FCC regulations. Changes or modifications to this unit not expressly approved by the party responsible for compliance could void the user's authority to operate this equipment.



DO NOT throw the motherboard in municipal waste. This product has been designed to enable proper reuse of parts and recycling. This symbol of the crossed out wheeled bin indicates that the product (electrical and electronic equipment) should not be placed in municipal waste. Check local regulations for disposal of electronic products.



DO NOT throw the mercury-containing button cell battery in municipal waste. This symbol of the crossed out wheeled bin indicates that the battery should not be placed in municipal waste.



電子信息產品污染控制標示：圖中之數字為產品之環保使用期限。僅指電子信息產品中含有的有毒有害物質或元素不致發生外洩或突變從而對環境造成污染或對人身、財產造成嚴重損害的期限。

有毒有害物質或元素的名稱及含量說明標示：

部件名稱	有害物質或元素					
	鉛 (Pb)	汞 (Hg)	鎘 (Cd)	六 價 鉻 (Cr(VI))	多 溴 聯 苯 (PBB)	多 溴 二 苯 醚 (PBDE)
印刷電路板及其電子組件	×	○	○	○	○	○
外部信號連接頭及線材	×	○	○	○	○	○

○：表示該有毒有害物質在該部件所有均質材料中的含量均在 SJ/T 11363-2006 標準規定的限量要求以下。

×

×：表示該有毒有害物質至少在該部件的某一均質材料中的含量超出 SJ/T 11363-2006 標準規定的限量要求，然該部件仍符合歐盟指令 2002/95/EC 的規範。

備註：此產品所標示之環保使用期限，係指在一般正常使用狀況下。