

COM-TGUC6

COM Express Module

User's Manual 1st Ed

Copyright Notice

This document is copyrighted, 2021. All rights are reserved. The original manufacturer reserves the right to make improvements to the products described in this manual at any time without notice.

No part of this manual may be reproduced, copied, translated, or transmitted in any form or by any means without the prior written permission of the original manufacturer. Information provided in this manual is intended to be accurate and reliable. However, the original manufacturer assumes no responsibility for its use, or for any infringements upon the rights of third parties that may result from its use.

The material in this document is for product information only and is subject to change without notice. While reasonable efforts have been made in the preparation of this document to assure its accuracy, AAEON assumes no liabilities resulting from errors or omissions in this document, or from the use of the information contained herein.

AAEON reserves the right to make changes in the product design without notice to its users.

Acknowledgements

All other products' name or trademarks are properties of their respective owners.

- Microsoft Windows is a registered trademark of Microsoft Corp.
- Intel® and Celeron® are registered trademarks of Intel Corporation
- Intel Core™ is a trademark of Intel Corporation
- ITE is a trademark of Integrated Technology Express, Inc.
- IBM, PC/AT, PS/2, and VGA are trademarks of International Business Machines Corporation.

All other product names or trademarks are properties of their respective owners.

Omission from this list does not imply any claim of ownership by the publisher of this document.

Packing List

Before setting up your product, please make sure the following items have been shipped:

Item	Quantity
● COM-TGUC6	1

If any of these items are missing or damaged, please contact your distributor or sales representative immediately.

About this Document

This User's Manual contains all the essential information, such as detailed descriptions and explanations on the product's hardware and software features (if any), its specifications, dimensions, jumper/connector settings/definitions, and driver installation instructions (if any), to facilitate users in setting up their product.

Users may refer to the product page at AAEON.com for the latest version of this document.

Safety Precautions

Please read the following safety instructions carefully. It is advised that you keep this manual for future references

1. All cautions and warnings on the device should be noted.
2. Make sure the power source matches the power rating of the device.
3. Position the power cord so that people cannot step on it. Do not place anything over the power cord.
4. Always completely disconnect the power before working on the system's hardware.
5. No connections should be made when the system is powered as a sudden rush of power may damage sensitive electronic components.
6. If the device is not to be used for a long time, disconnect it from the power supply to avoid damage by transient over-voltage.
7. Always disconnect this device from any AC supply before cleaning.
8. While cleaning, use a damp cloth instead of liquid or spray detergents.
9. Make sure the device is installed near a power outlet and is easily accessible.
10. Keep this device away from humidity.
11. Place the device on a solid surface during installation to prevent falls
12. Do not cover the openings on the device to ensure optimal heat dissipation.
13. Watch out for high temperatures when the system is running.
14. Do not touch the heat sink or heat spreader when the system is running
15. Never pour any liquid into the openings. This could cause fire or electric shock.
16. As most electronic components are sensitive to static electrical charge, be sure to ground yourself to prevent static charge when installing the internal components. Use a grounding wrist strap and contain all electronic components in any static-shielded containers.

17. If any of the following situations arises, please contact our service personnel:
 - i. Damaged power cord or plug
 - ii. Liquid intrusion to the device
 - iii. Exposure to moisture
 - iv. Device is not working as expected or in a manner as described in this manual
 - v. The device is dropped or damaged
 - vi. Any obvious signs of damage displayed on the device
18. **DO NOT LEAVE THIS DEVICE IN AN UNCONTROLLED ENVIRONMENT WITH TEMPERATURES BEYOND THE DEVICE'S PERMITTED STORAGE TEMPERATURES (SEE CHAPTER 1) TO PREVENT DAMAGE.**

FCC Statement

Warning!



This device complies with Part 15 FCC Rules. Operation is subject to the following two conditions: (1) this device may not cause harmful interference, and (2) this device must accept any interference received including interference that may cause undesired operation.

Caution:

There is a danger of explosion if the battery is incorrectly replaced. Replace only with the same or equivalent type recommended by the manufacturer. Dispose of used batteries according to the manufacturer's instructions and your local government's recycling or disposal directives.

Attention:

Il y a un risque d'explosion si la batterie est remplacée de façon incorrecte. Ne la remplacer qu'avec le même modèle ou équivalent recommandé par le constructeur. Recycler les batteries usées en accord avec les instructions du fabricant et les directives gouvernementales de recyclage.

China RoHS Requirements (CN)

产品中有毒有害物质或元素名称及含量

AAEON Main Board/Daughter Board/Backplane

部件名称	有毒有害物质或元素					
	铅 (Pb)	汞 (Hg)	镉 (Cd)	六价铬 (Cr(VI))	多溴联苯 (PBB)	多溴二苯醚 (PBDE)
印刷电路板 及其电子组件	○	○	○	○	○	○
外部信号 连接器及线材	○	○	○	○	○	○

○：表示该有毒有害物质在该部件所有均质材料中的含量均在 SJ/T 11363-2006 标准规定的限量要求以下。

X：表示该有毒有害物质至少在该部件的某一均质材料中的含量超出 SJ/T 11363-2006 标准规定的限量要求。

备注：此产品所标示之环保使用期限，系指在一般正常使用状况下。

China RoHS Requirement (EN)

Poisonous or Hazardous Substances or Elements in Products

AAEON Main Board/Daughter Board/Backplane

Component	Poisonous or Hazardous Substances or Elements					
	Lead (Pb)	Mercury (Hg)	Cadmium (Cd)	Hexavalent Chromium (Cr(VI))	Polybrominated Biphenyls (PBB)	Polybrominated Diphenyl Ethers (PBDE)
PCB & Other Components	○	○	○	○	○	○
Wires & Connectors for External Connections	○	○	○	○	○	○
<p>O: The quantity of poisonous or hazardous substances or elements found in each of the component's parts is below the SJ/T 11363-2006-stipulated requirement.</p> <p>X: The quantity of poisonous or hazardous substances or elements found in at least one of the component's parts is beyond the SJ/T 11363-2006-stipulated requirement.</p> <p>Note: The Environment Friendly Use Period as labeled on this product is applicable under normal usage only</p>						

Table of Contents

Chapter 1 - Product Specifications	1
1.1 Specifications	2
Chapter 2 – Hardware Information	4
2.1 Dimensions	5
2.2 Jumpers and Connectors	7
2.3 List of Connectors.....	8
2.3.1 COM Express ROW A/B Connector (CN2)	8
2.3.2 COM Express ROW C/D Connector (CN3).....	13
2.5 Function Block Diagram	18
Chapter 3 - AMI BIOS Setup	19
3.1 System Test and Initialization	20
3.2 AMI BIOS Setup.....	21
3.3 Setup Submenu: Main.....	22
3.4 Setup Submenu: Advanced	23
3.4.1 Graphics Configuration.....	24
3.4.1.1 LVDS Panel Configuration	25
3.4.2 CPU Configuration.....	27
3.4.3 Memory Configuration.....	29
3.4.4 On-Module H/W Monitor	30
3.4.4.1 Smart Fan Mode Configuration	31
3.4.5 PCH-FW Configuration.....	34
3.4.6.1 Firmware Update Configuration	35
3.4.6 On-Module Configuration	36
3.4.7 Power Management	37
3.4.8 AAEON BIOS Robot.....	38
3.5 Setup Submenu: System I/O	40

3.5.1	PCI Express Configuration	41
3.5.2	Storage Configuration	44
3.5.3	HD Audio Configuration	46
3.5.4	Digital IO Port Configuration	47
3.5.5	Legacy Logical Devices Configuration	48
3.5.5.1	Serial Port 1 Configuration	49
3.5.5.2	Serial Port 2 Configuration	50
3.5.6	Serial Port Console Redirection	51
3.6	Setup Submenu: Security	52
3.6.1	Trusted Computing	53
3.6.2	Secure Boot	55
3.6.1.1	Key Management	56
3.7	Setup Submenu: Boot	57
3.8	Setup submenu: Save & Exit	58
Chapter 4 – Drivers Installation		59
4.1	Drivers Download and Installation	60
Appendix A - Watchdog Timer		63
A.1	Watchdog Timer Initial Program	64
Appendix B - I/O Information		69
B.1	I/O Address Map	70
B.2	Memory Address Map	72
B.3	Large Memory Address Map	73
B.4	IRQ Mapping Chart	74
Appendix C – Programming Digital I/O		85
C.1	Digital I/O Programming	86
C.2	Digital I/O Register	86
C.3	Digital I/O Sample Program	87

Chapter 1

Product Specifications

1.1 Specifications

System

Form Factor	COM Express Compact size, Type 6
CPU	11th Gen Intel® Core™ Series Processor
CPU Frequency	Up to 1.8 GHz, i7-1185GRE
Chipset	11th Gen Intel® Core™ Series Processor
Memory Type	DDR4 3200 SODIMM x 2
Max. Memory Capacity	Up to 32GB
BIOS	AMI BIOS
Wake on LAN	Yes
Watchdog Timer	255 Levels
Power Requirement	Standard: +12V
Power Supply Type	AT/ ATX Mode
Power Consumption (Typical)	3.5A at 12V, full load, i7-1185GRE
Dimensions (L x W)	3.74" x 3.74" (95mm x 95mm)
Operating Temperature	32°F ~ 140°F (0°C ~ 60°C)
Storage Temperature	-40°F ~ 185°F (-40°C ~ 85°C)
Operating Humidity	0% ~ 90% relative humidity, non-condensing
MTBF (Hours)	TBD
Certification	CE/FCC Class A

Display

VGA/LCD Controller	Intel® Iris® Xe Graphics/ UHD Graphics
Video Output	4 Simultaneous Displays: 18/24-bit 2 Channel LVDS/eDP x 1 (Default: LVDS) DDI x 3 VGA x 1

I/O

Ethernet	Intel® i225LM, up to 2.5 Gbps Ethernet x 1
Audio	High Definition Audio Interface
USB Port	USB2.0 x 8 USB3.2 Gen 2 x 4
Serial Port	2-wire UART x 2 (TX/RX)
HDD Interface	SATA III x 2
Expansion	PCIe Gen 4 [x4] x 1 PCIe Gen 3 [x1] x 5 LPC SMBus I2C
GPIO	GPIO 8-bit
Onboard Storage	--
TPM	2.0 (Optional)

Chapter 2

Hardware Information

2.1 Dimensions

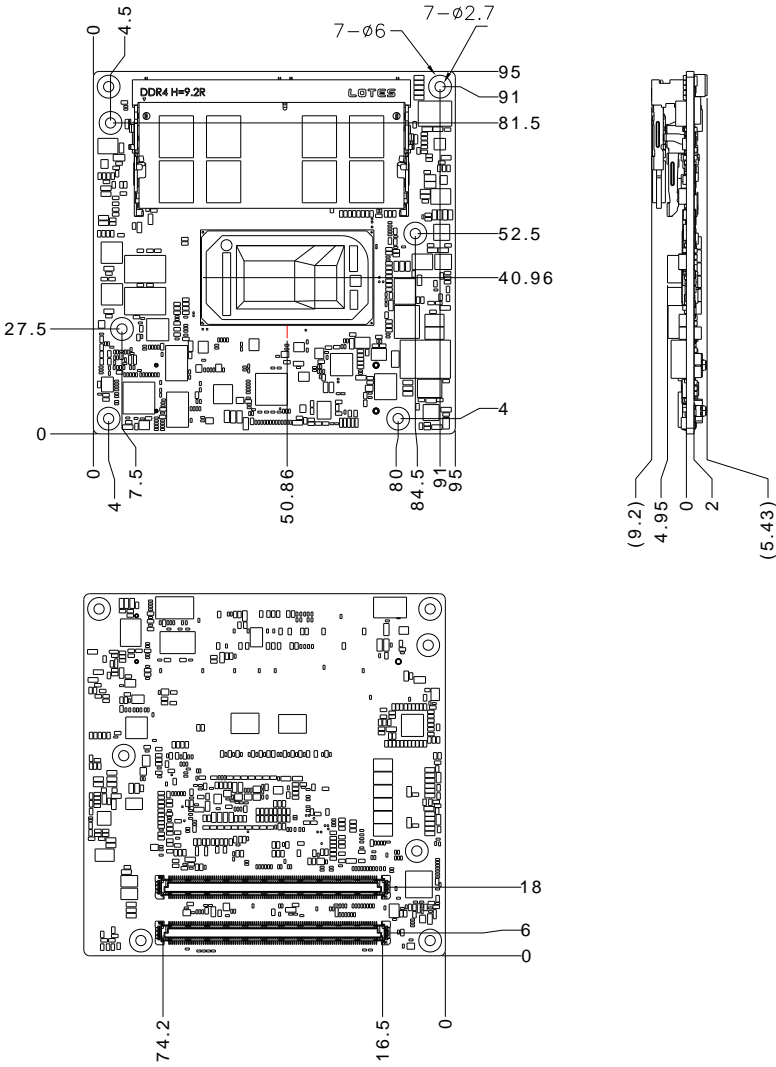

With Active Cooling (Part No: COM-TGUC6-FAN01)

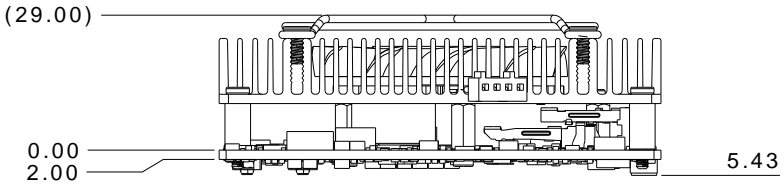

With Heat Spreader and Active Cooling (Part No: COM-TGUC6-HSP01 and COM-FAN02)

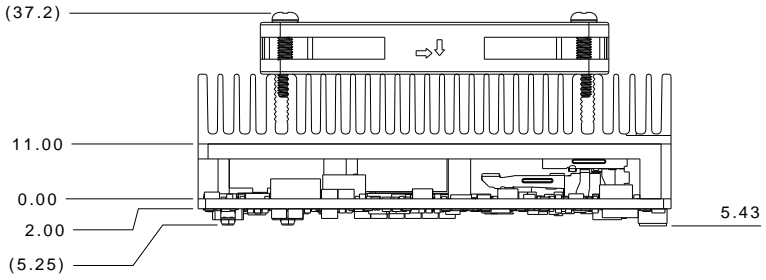

2.2 Jumpers and Connectors

Top Side

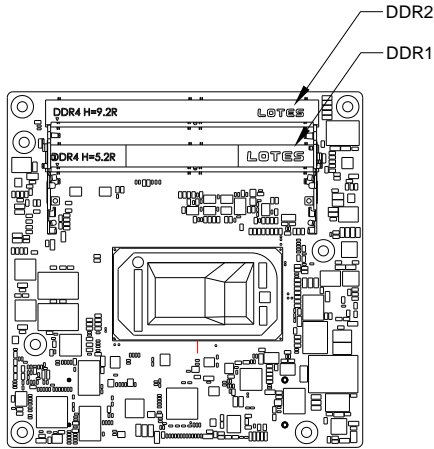

Bottom Side

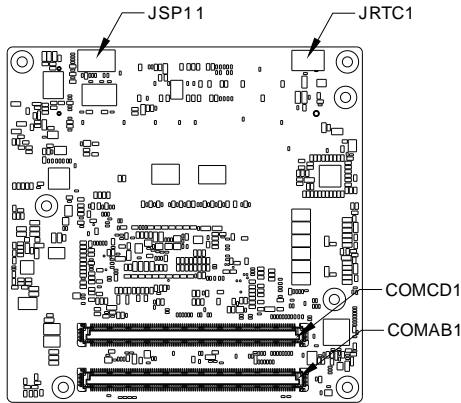

2.3 List of Connectors

Please refer to the table below for all of the board's connectors that you can configure for your application

Label	Function
COMAB1	Express ROW A/B Connector
COMCD1	Express ROW C/D Connector
DDR1	DDR4 SO-DIMMCOM Connector
DDR2	DDR4 SO-DIMMCOM Connector

2.3.1 COM Express ROW A/B Connector (CN2)

Row A		Row B	
Pin	Signal	Pin	Signal
A1	GND (FIXED)	B1	GND (FIXED)
A2	GBE0_MDI3-	B2	GBE0_ACT#
A3	GBE0_MDI3+	B3	LPC_FRAME#
A4	GBE0_LINK100#	B4	LPC_AD0
A5	GBE0_LINK1000#	B5	LPC_AD1
A6	GBE0_MDI2-	B6	LPC_AD2
A7	GBE0_MDI2+	B7	LPC_AD3
A8	GBE0_LINK#	B8	NA
A9	GBE0_MDI1-	B9	NA
A10	GBE0_MDI1+	B10	LPC_CLK
A11	GND (FIXED)	B11	GND (FIXED)
A12	GBE0_MDI0-	B12	PWRBTN#
A13	GBE0_MDI0+	B13	SMB_CK

Row A		Row B	
Pin	Signal	Pin	Signal
A14	NA	B14	SMB_DAT
A15	SUS_S3#	B15	SMB_ALERT#
A16	SATA0_TX+	B16	SATA1_TX+
A17	SATA0_TX-	B17	SATA1_TX-
A18	SUS_S4#	B18	SUS_STAT#
A19	SATA0_RX+	B19	SATA1_RX+
A20	SATA0_RX-	B20	SATA1_RX-
A21	GND (FIXED)	B21	GND (FIXED)
A22	NA	B22	NA
A23	NA	B23	NA
A24	SUS_S5#	B24	PWR_OK
A25	NA	B25	NA
A26	NA	B26	NA
A27	BATLOW#	B27	WDT
A28	(S)ATA_ACT#	B28	NA
A29	AC/HDA_SYNC	B29	HDA_SDIN1
A30	AC/HDA_RST#	B30	HDA_SDIN0
A31	GND (FIXED)	B31	GND (FIXED)
A32	HDA_BITCLK	B32	SPKR
A33	HDA_SDOOUT	B33	I2C_CK
A34	BIOS_DIS0#	B34	I2C_DAT
A35	THRMTRIP#	B35	THRM#
A36	USB6-	B36	USB7-
A37	USB6+	B37	USB7+
A38	USB_6_7_OC#	B38	USB_4_5_OC#

Row A		Row B	
Pin	Signal	Pin	Signal
A39	USB4-	B39	USB5-
A40	USB4+	B40	USB5+
A41	GND (FIXED)	B41	GND (FIXED)
A42	USB2-	B42	USB3-
A43	USB2+	B43	USB3+
A44	USB_2_3_OC#	B44	USB_0_1_OC#
A45	USB0-	B45	USB1-
A46	USB0+	B46	USB1+
A47	VCC_RTC	B47	EXCD1_PERST#(Option)
A48	EXCD0_PERST#	B48	NA
A49	NA	B49	SYS_RESET#
A50	LPC_SERIRQ	B50	CB_RESET#
A51	GND (FIXED)	B51	GND (FIXED)
A52	NA	B52	NA
A53	NA	B53	NA
A54	GPIO	B54	GPO1
A55	PCIE_TX4+	B55	PCIE_RX4+
A56	PCIE_TX4-	B56	PCIE_RX4-
A57	GND	B57	GPO2
A58	PCIE_TX3+	B58	PCIE_RX3+
A59	PCIE_TX3-	B59	PCIE_RX3-
A60	GND (FIXED)	B60	GND (FIXED)
A61	PCIE_TX2+	B61	PCIE_RX2+
A62	PCIE_TX2-	B62	PCIE_RX2-
A63	GPI1	B63	GPO3

Row A		Row B	
Pin	Signal	Pin	Signal
A64	PCIE_TX1+	B64	PCIE_RX1+
A65	PCIE_TX1-	B65	PCIE_RX1-
A66	GND	B66	WAKE0#
A67	GPI2	B67	WAKE1#
A68	PCIE_TX0+	B68	PCIE_RX0+
A69	PCIE_TX0-	B69	PCIE_RX0-
A70	GND (FIXED)	B70	GND (FIXED)
A71	LVDS_A0+	B71	LVDS_B0+
A72	LVDS_A0-	B72	LVDS_B0-
A73	LVDS_A1+	B73	LVDS_B1+
A74	LVDS_A1-	B74	LVDS_B1-
A75	LVDS_A2+	B75	LVDS_B2+
A76	LVDS_A2-	B76	LVDS_B2-
A77	LVDS_VDD_EN	B77	LVDS_B3+
A78	LVDS_A3+	B78	LVDS_B3-
A79	LVDS_A3-	B79	LVDS_BKLT_EN
A80	GND (FIXED)	B80	GND (FIXED)
A81	LVDS_A_CK+	B81	LVDS_B_CK+
A82	LVDS_A_CK-	B82	LVDS_B_CK-
A83	LVDS_I2C_CK	B83	LVDS_BKLT_CTRL
A84	LVDS_I2C_DAT	B84	VCC_5V_SBY
A85	GPI3	B85	VCC_5V_SBY
A86	KB_RST#(Option)	B86	VCC_5V_SBY
A87	EDP_HPD	B87	VCC_5V_SBY
A88	PCIE_CLK_REF+	B88	BIOS_DIS1#

Row A		Row B	
Pin	Signal	Pin	Signal
A89	PCIE_CLK_REF-	B89	VGA_RED
A90	GND (FIXED)	B90	GND (FIXED)
A91	SPI_POWER	B91	VGA_GRN
A92	SPI_MISO	B92	VGA_BLU
A93	GPO0	B93	VGA_HSYNC
A94	SPI_CLK	B94	VGA_VSYNC
A95	SPI_MOSI	B95	VGA_I2C_CK
A96	TPM_PP	B96	VGA_I2C_DAT
A97	NA	B97	SPI_CS#
A98	SER0_TX	B98	SMI#(Option)
A99	SER0_RX	B99	SCI#(Option)
A100	GND (FIXED)	B100	GND (FIXED)
A101	SER1_TX	B101	FAN_PWMOUT
A102	SER1_RX	B102	FAN_TACHIN
A103	LID#	B103	SLEEP#
A104	VCC_12V	B104	VCC_12V
A105	VCC_12V	B105	VCC_12V
A106	VCC_12V	B106	VCC_12V
A107	VCC_12V	B107	VCC_12V
A108	VCC_12V	B108	VCC_12V
A109	VCC_12V	B109	VCC_12V
A110	GND (FIXED)	B110	GND (FIXED)

2.4.2 COM Express ROW C/D Connector (CN3)

Row C		Row D	
Pin	Signal	Pin	Signal
C1	GND (FIXED)	D1	GND (FIXED)
C2	GND	D2	GND
C3	USB_SSRX0-	D3	USB_SSTX0-
C4	USB_SSRX0+	D4	USB_SSTX0+
C5	GND	D5	GND
C6	USB_SSRX1-	D6	USB_SSTX1-
C7	USB_SSRX1+	D7	USB_SSTX1+
C8	GND	D8	GND
C9	USB_SSRX2-	D9	USB_SSTX2-
C10	USB_SSRX2+	D10	USB_SSTX2+
C11	GND (FIXED)	D11	GND (FIXED)
C12	USB_SSRX3-	D12	USB_SSTX3-
C13	USB_SSRX3+	D13	USB_SSTX3+
C14	GND	D14	GND
C15	NA	D15	DDI1_CTRLCLK_AUX+
C16	NA	D16	DDI1_CTRLDATA_AUX-
C17	NA	D17	NA
C18	NA	D18	NA
C19	NA	D19	NA
C20	NA	D20	NA
C21	GND (FIXED)	D21	GND (FIXED)
C22	NA	D22	NA

Row C		Row D	
Pin	Signal	Pin	Signal
C23	NA	D23	NA
C24	DDI1_HPD	D24	NA
C25	NA	D25	NA
C26	NA	D26	DDI1_PAIR0+
C27	NA	D27	DDI1_PAIR0-
C28	NA	D28	NA
C29	NA	D29	DDI1_PAIR1+
C30	NA	D30	DDI1_PAIR1-
C31		D31	GND (FIXED)
C32	DDI2_CTRLCLK_AUX+	D32	DDI1_PAIR2+
C33	DDI2_CTRLCLK_AUX-	D33	DDI1_PAIR2-
C34	DDI2_DDC_AUX_SEL	D34	DDI1_DDC_AUX_SEL
C35	NA	D35	NA
C36	DDI3_CTRLCLK_AUX+	D36	DDI1_PAIR3+
C37	DDI3_CTRLCLK_AUX-	D37	DDI1_PAIR3-
C38	DDI3_DDC_AUX_SEL	D38	NA
C39	DDI3_PAIR0+	D39	DDI2_PAIR0+
C40	DDI3_PAIR0-	D40	DDI2_PAIR0-
C41	GND(FIXED)	D41	GND (FIXED)
C42	DDI3_PAIR1+	D42	DDI2_PAIR1+
C43	DDI3_PAIR1-	D43	DDI2_PAIR1-
C44	DDI3_HPD	D44	DDI2_HPD
C45	NA	D45	NA
C46	DDI3_PAIR2+	D46	DDI2_PAIR2+
C47	DDI3_PAIR2-	D47	DDI2_PAIR2-

Row C		Row D	
Pin	Signal	Pin	Signal
C48	NA	D48	NA
C49	DDI3_PAIR3+	D49	DDI2_PAIR3+
C50	DDI3_PAIR3-	D50	DDI2_PAIR3-
C51	GND(FIXED)	D51	GND (FIXED)
C52	PEG_RX0+	D52	PEG_TX0+
C53	PEG_RX0-	D53	PEG_TX0-
C54	NA	D54	PEG_LANE_RV#
C55	PEG_RX1+	D55	PEG_TX1+
C56	PEG_RX1-	D56	PEG_TX1-
C57	NA	D57	TYPE2#
C58	PEG_RX2+	D58	PEG_TX2+
C59	PEG_RX2-	D59	PEG_TX2-
C60	GND(FIXED)	D60	GND(FIXED)
C61	PEG_RX3+	D61	PEG_TX3+
C62	PEG_RX3-	D62	PEG_TX3-
C63	NA	D63	NA
C64	NA	D64	NA
C65	NA	D65	NA
C66	NA	D66	NA
C67	NA	D67	GND
C68	NA	D68	NA
C69	NA	D69	NA
C70	GND (FIXED)	D70	GND (FIXED)
C71	NA	D71	NA
C72	NA	D72	NA

Row C		Row D	
Pin	Signal	Pin	Signal
C73	GND	D73	GND
C74	NA	D74	NA
C75	NA	D75	NA
C76	GND	D76	GND
C77	NA	D77	NA
C78	NA	D78	NA
C79	NA	D79	NA
C80	GND (FIXED)	D80	GND (FIXED)
C81	NA	D81	NA
C82	NA	D82	NA
C83	NA	D83	NA
C84	GND	D84	GND
C85	NA	D85	NA
C86	NA	D86	NA
C87	GND	D87	GND
C88	NA	D88	NA
C89	NA	D89	NA
C90	GND (FIXED)	D90	GND (FIXED)
C91	NA	D91	NA
C92	NA	D92	NA
C93	GND	D93	GND
C94	NA	D94	NA
C95	NA	D95	NA
C96	GND	D96	GND
C97	NA	D97	NA

Row C		Row D	
Pin	Signal	Pin	Signal
C98	NA	D98	NA
C99	NA	D99	NA
C100	GND (FIXED)	D100	GND (FIXED)
C101	NA	D101	NA
C102	NA	D102	NA
C103	GND	D103	GND
C104	VCC_12V	D104	VCC_12V
C105	VCC_12V	D105	VCC_12V
C106	VCC_12V	D106	VCC_12V
C107	VCC_12V	D107	VCC_12V
C108	VCC_12V	D108	VCC_12V
C109	VCC_12V	D109	VCC_12V
C110	GND (FIXED)	D110	GND (FIXED)

2.5 Function Block Diagram

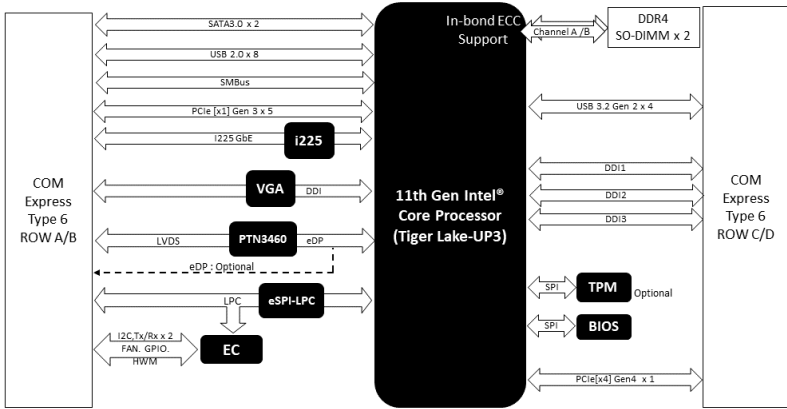

Chapter 3

AMI BIOS Setup

3.1 System Test and Initialization

The board uses certain routines to test and initialize board hardware. If the routines encounter an error during the tests, you will either hear a few short beeps or see an error message on the screen. There are two kinds of errors: fatal and non-fatal. The system can usually continue the boot up sequence with non-fatal errors.

System configuration verification routines check the current system configuration stored in the CMOS memory and BIOS NVRAM. If a system configuration is not found or a system configuration data error is detected, the system will load the optimized default and re-boot with this default system configuration automatically.

There are four situations in which you will need to setup system configuration:

- You are starting your system for the first time.
- You have changed the hardware attached to your system.
- The CMOS memory has lost power and the configuration information has been erased.

The COM-TGUC6 CMOS memory uses a backup battery for data retention. The battery must be replaced if it runs out of power.

3.2 AMI BIOS Setup

The AMI BIOS ROM has a built-in Setup program that allows users to modify the basic system configuration. This information is stored in the battery-backed CMOS RAM and BIOS NVRAM so it retains the Setup information when the power is turned off.

To enter Setup, power on the computer and press immediately.

The function of each menu is as follows:

Main – Date and time can be set here. Use <Tab> to switch between date elements.

Advanced – Enable/disable boot option for legacy network devices.

System I/O – System I/O information and configuration.

Security – Password for setup administrator can be set here.

Boot – Enable/disable Quiet Boot option.

Save & Exit – Save changes and exit Setup.

3.3 Setup Submenu: Main

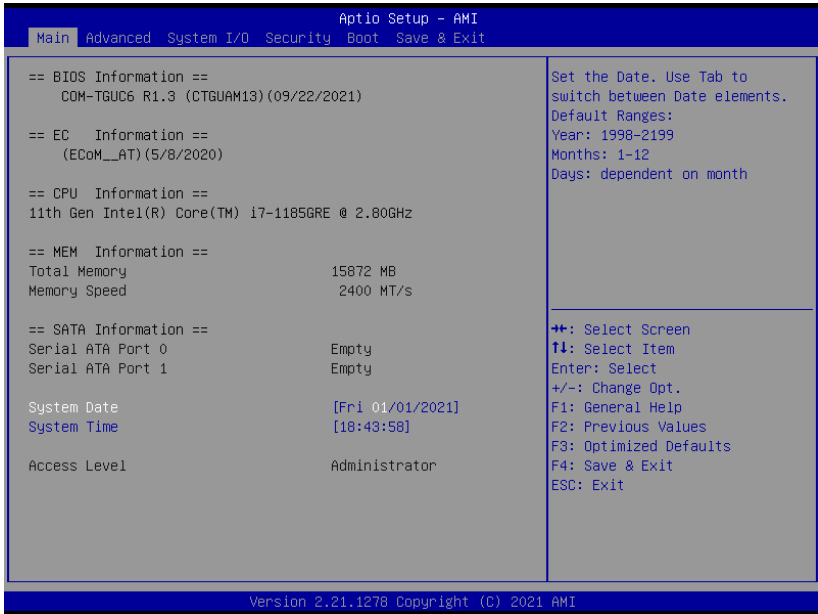

3.4 Setup Submenu: Advanced

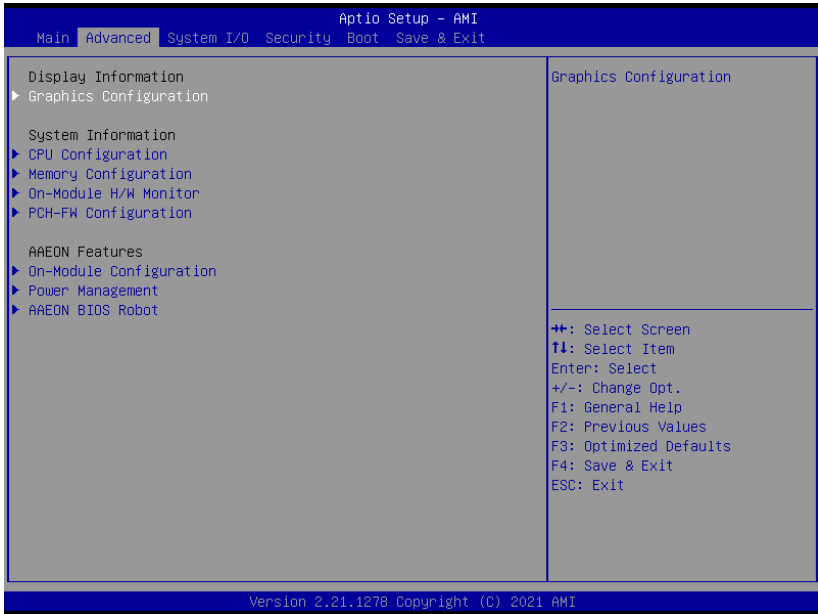

3.4.1 Graphics Configuration

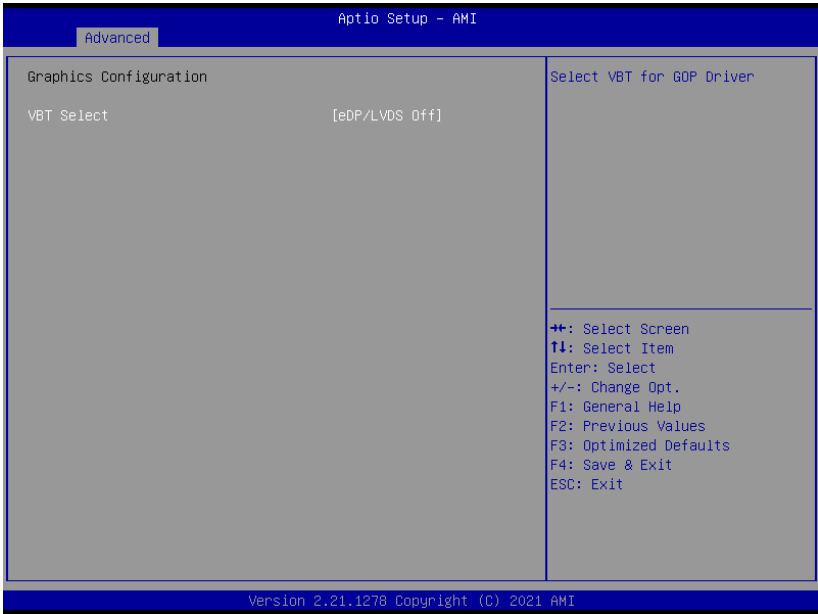

Options Summary		
VBT Select	LVDS On	
	eDP On	
	eDP/LVDS Off	Optimal Default, Failsafe Default
Select VBT for GOP Driver		

3.4.1.1 LVDS Panel Configuration

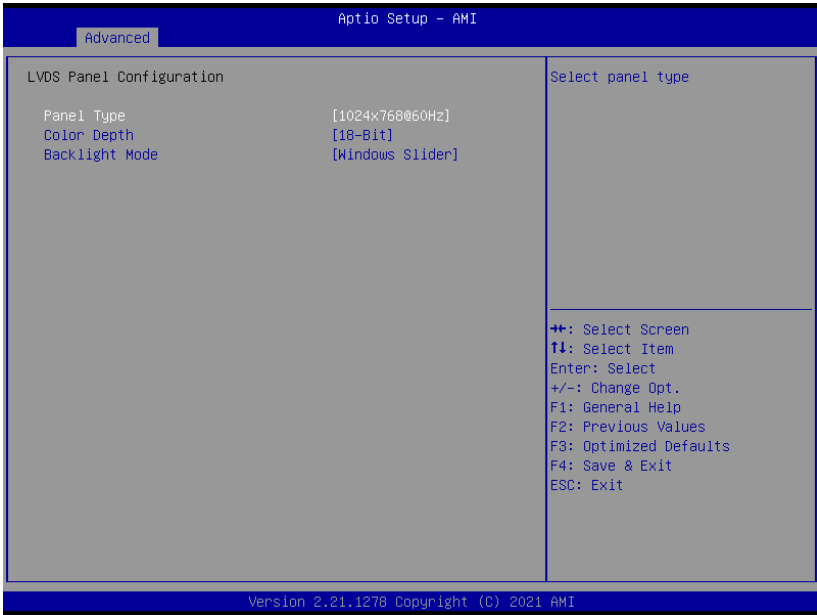

Options Summary		
Panel Type	640x480@60Hz	Optimal Default, Failsafe Default
	800x480@60Hz	
	800x600@60Hz	
	1024x600@60Hz	
	1024x768@60Hz	
	1280x768@60Hz	
	1280x800@60Hz	
	1280x1024@60Hz	
	1366x768@60Hz	
	1440x900@60Hz	
	1600x1200@60Hz	
1920x1080@60Hz		
1920x1200@60Hz		
Select panel type		

Table Continues on Next Page...

Options Summary		
Color Depth	18-Bit	Optimal Default, Failsafe Default
	24-Bit	
	36-Bit	
	48-Bit	
Select panel type		
Backlight Mode	BIOS & Application	Optimal Default, Failsafe Default
	Windows Slider	
Select backlight control signal type		

3.4.2 CPU Configuration

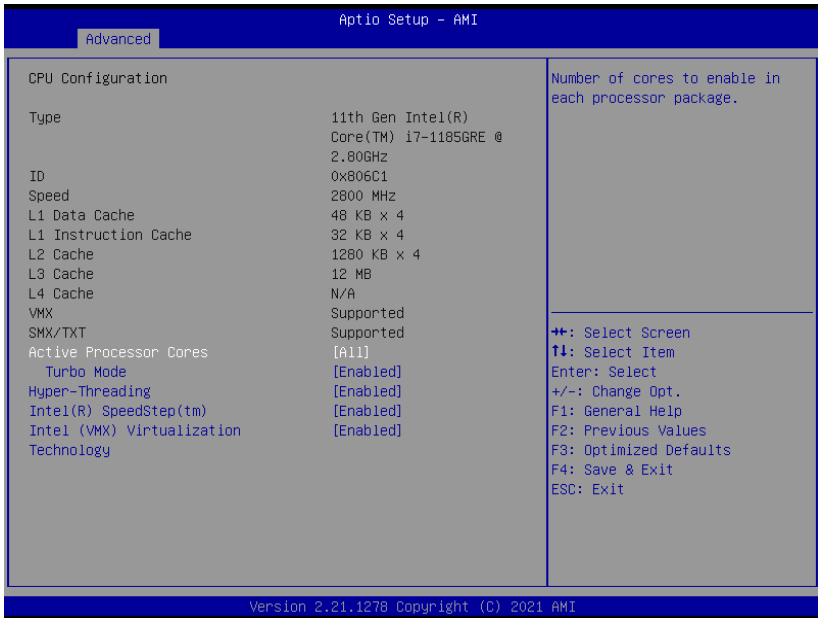

Options Summary		
Active Processor Cores	All	Optimal Default, Failsafe Default
	1	
	2	
	3	
Number of cores to enable in each processor package.		
Turbo Mode	Disabled	
	Enabled	Optimal Default, Failsafe Default
Enable/Disable processor Turbo Mode (requires EMTTM enabled too). AUTO means enabled		
Hyper-Threading	Disabled	
	Enabled	Optimal Default, Failsafe Default
Enable or Disable Hyper-Threading Technology.		
Intel(R) SpeedStep(tm)	Disabled	
	Enabled	Optimal Default, Failsafe Default
Allows more than two frequency ranges to be supported.		

Options Summary		
Intel (VMX) Virtualization	Disabled	
Technology	Enabled	Optimal Default, Failsafe Default
When enabled, a VMM can utilize the additional hardware capabilities provided by Vanderpool Technology.		

3.4.3 Memory Configuration

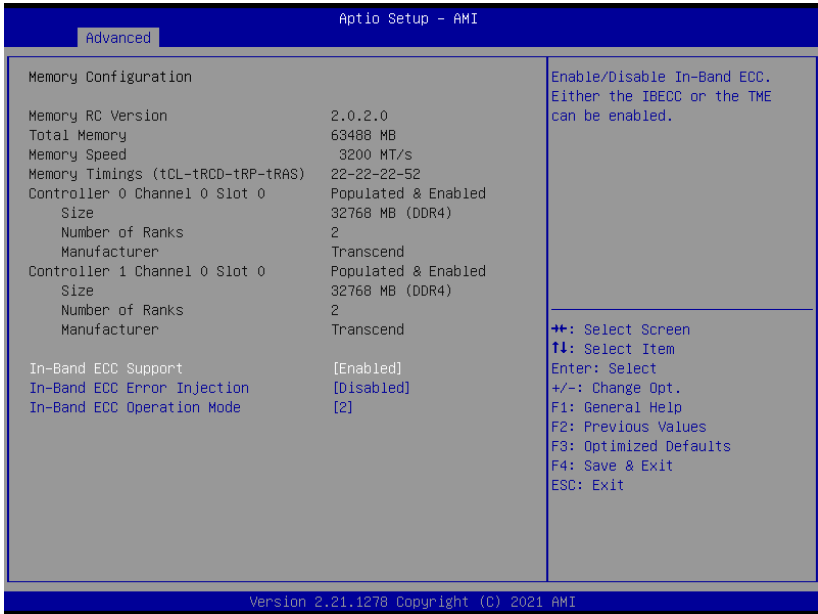

Options Summary		
In-Band ECC Support	Disabled	
	Enabled	Optimal Default, Failsafe Default
Enable/Disable In-Band ECC. Either the IBECC or the TME can be enabled.		
In-Band ECC Error Injection	Disabled	Optimal Default, Failsafe Default
	Enabled	
By enabling this Error Injection feature, the user acknowledges the security risks. Enabling Error Injection allows attackers who have access to the Host Operating System to inject IBECC errors that can cause unintended memory corruption and enable the leak of security data in the BIOS stolen memory regions.		
In-Band ECC Error Operation Mode	0	
	1	
	2	Optimal Default, Failsafe Default
0: Functional Mode protects requests based on the address range, 1: Makes all requests non-protected and ignore range checks, 2: Makes all requests protected and ignore range checks		

3.4.4 On-Module H/W Monitor

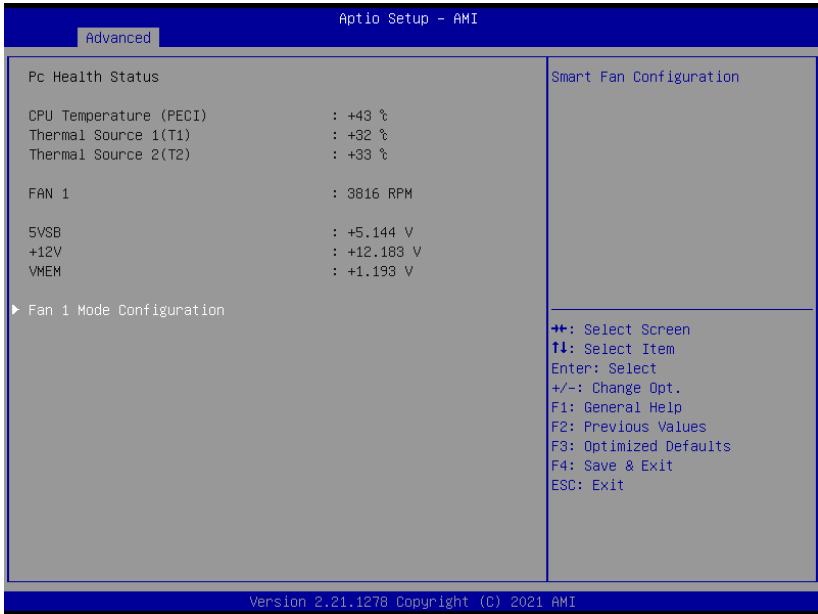

3.4.4.1 Smart Fan Mode Configuration

FAN 1: Full Mode

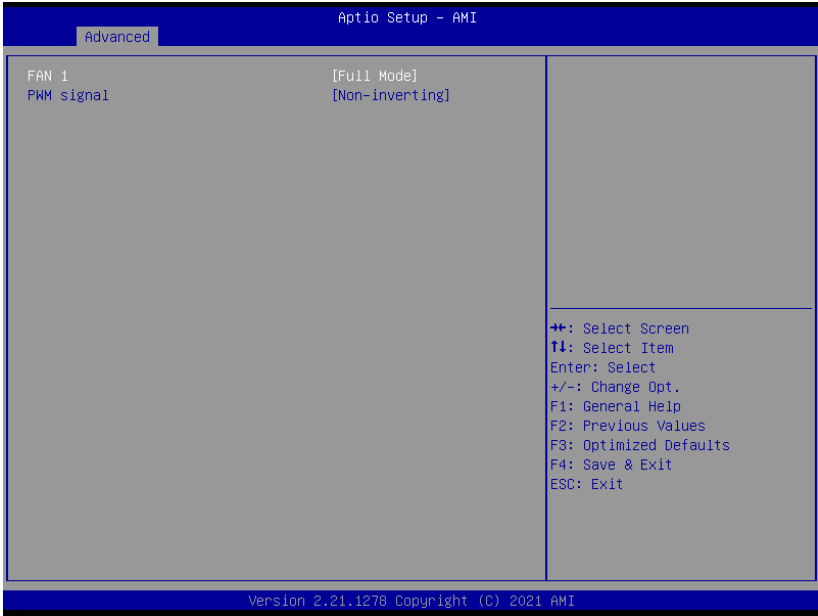

Options Summary		
FAN 1	Full Mode	Optimal Default, Failsafe Default
	Manual Mode by PWM	
	Auto Mode by PWM	
Smart Fan Mode Select		
PWM signal	Non-inverting	Optimal Default, Failsafe Default
	Inverting	
Select output PWM of inverting or non-inverting signal.		

FAN 1: Manual Mode by PWM



Options Summary

Manual Setting	70	Optimal Default, Failsafe Default
Set Fan at fixed Duty-Cycle Min=0 Max=100 Please input Dec number:		

FAN 1: Auto Mode by PWM

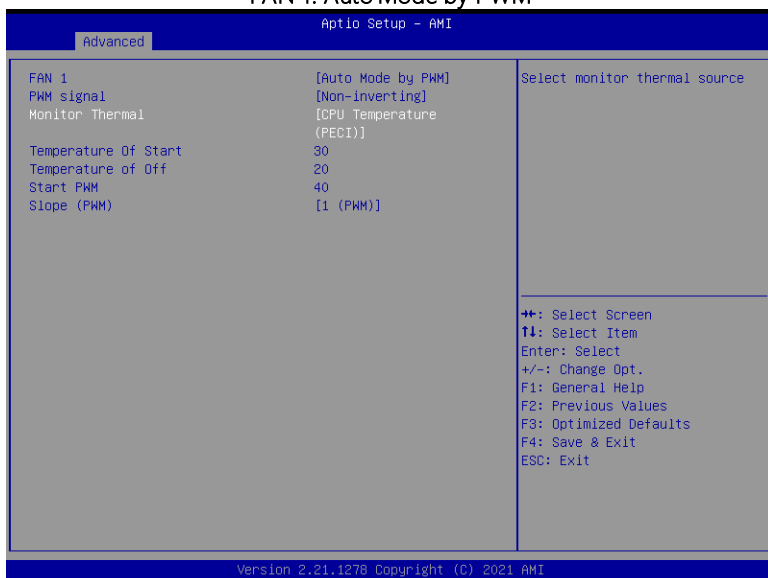

Options Summary		
Monitor Thermal	CPU Temperature (PECI)	Optimal Default, Failsafe Default
	Thermal Source 1(T1)	
	Thermal Source 2(T2)	
Select monitor thermal source		
Temperature Of Start	30	Optimal Default, Failsafe Default
Temperature Of Start		
Temperature of Off	20	Optimal Default, Failsafe Default
Temperature of Off		
Start PWM	40	Optimal Default, Failsafe Default
Start PWM		
Slope (PWM)	0 (PWM)	
	1 (PWM)	Optimal Default, Failsafe Default
	2 (PWM)	
	4 (PWM)	
	8 (PWM)	
	16 (PWM)	
	32 (PWM)	
	64 (PWM)	
Slope (PWM)		

3.4.5 PCH-FW Configuration

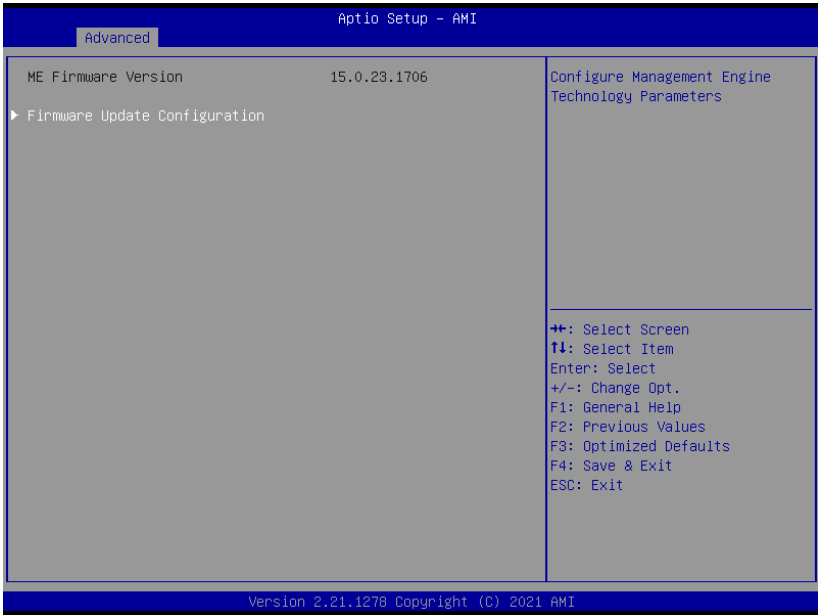

3.4.6.1 Firmware Update Configuration

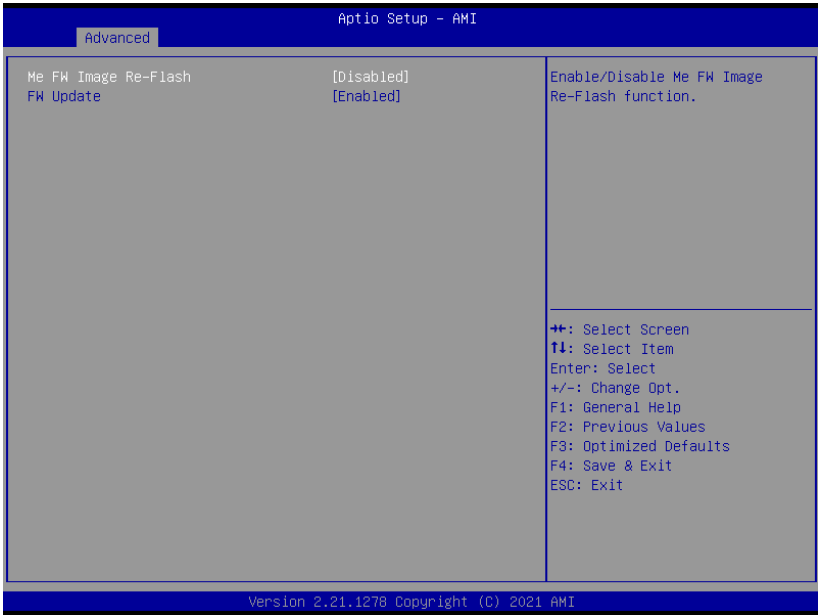

Options Summary		
Me FW Image Re-Flash	Disabled	Optimal Default, Failsafe Default
	Enabled	
Enable/ Disable Me FW Image Re-Flash Function.		
FW Update	Disabled	Optimal Default, Failsafe Default
	Enabled	
Enable/Disable ME FW Update Function		

3.4.6 On-Module Configuration

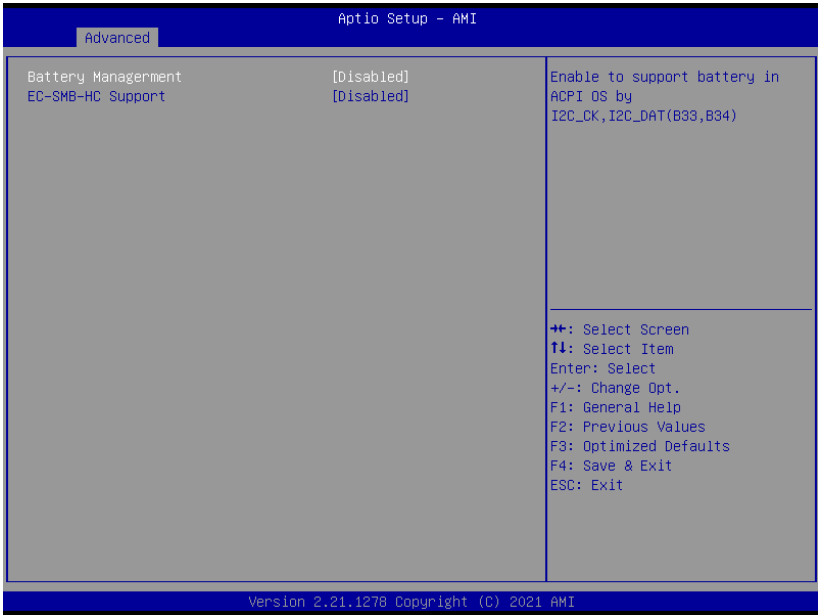

Options Summary		
Battery Management	Disabled	Optimal Default, Failsafe Default
	One Battery	
Enable to support battery in ACPI OS by I2C_CK, I2C_DAT (B33, B34)		
EC-SMB-HC Support	Disabled	Optimal Default, Failsafe Default
	Enabled	
SMBus Host Controller Interface via Embedded Controller.		

3.4.7 Power Management

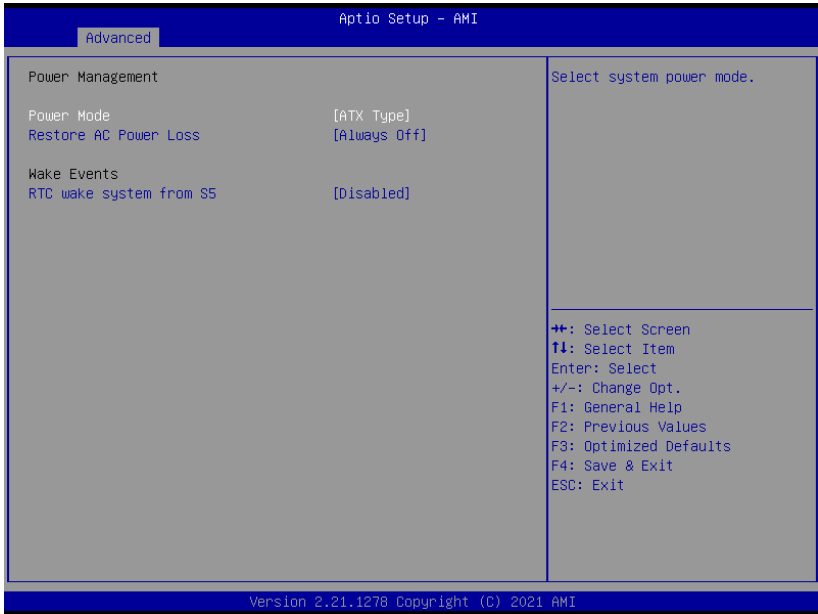

Options Summary		
Power Mode	ATX Type	Optimal Default, Failsafe Default
	AT Type	
Select system power mode.		
Restore AC Power Loss	Last State	Optimal Default, Failsafe Default
	Always On	
	Always Off	
SIO Restore AC Power Loss: To decide the behavior after system power cut then resupply. Note: The CMOS battery must be present.		
RTC wake system from S5	Disabled	Optimal Default, Failsafe Default
	Fixed Time	
	Dynamic Time	
	Bypass	
Fixed Time: System will wake on the hr::mn::sec Specified.		
Dynamic Time: System will wake on the current time + Increase minute(s)		
Bypass: BIOS will not control RTC wake function during system shutdown		

3.4.8 AAEON BIOS Robot

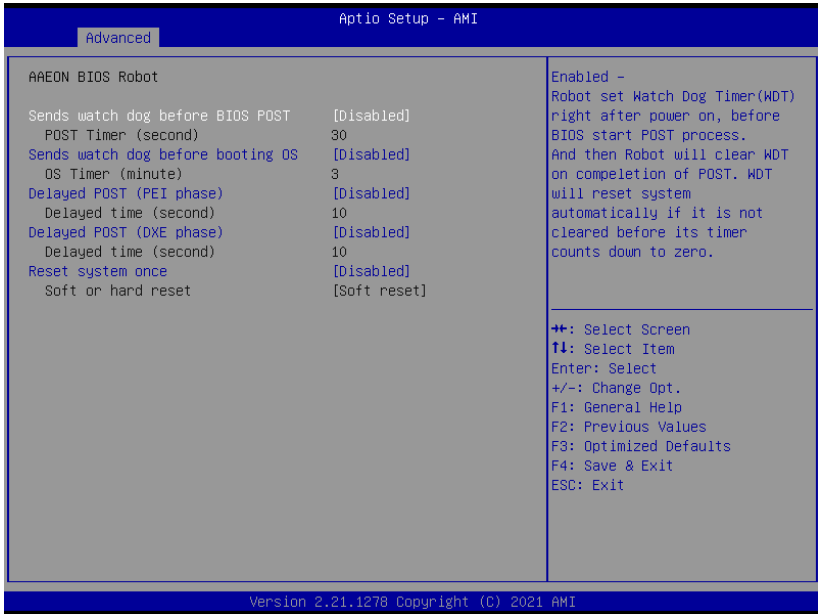

Options Summary		
Sends watch dog before BIOS POST	Disabled	Optimal Default, Failsafe Default
	Enabled	
Enabled - Robot set Watch Dog Timer (WDT) right after power on, before BIOS start POST process. And then Robot will clear WDT on completion of POST. WDT will reset system automatically if it is not cleared before its timer counts down to zero.		
Sends watch dog before booting OS	Disabled	Optimal Default, Failsafe Default
	Enabled	
Enabled - Robot set Watch Dog Timer (WDT) after POST completion before BIOS transfer control to OS. Warning: Before enabling this function, a program in OS must be in responsible for clearing WDT. Also, this function should be disabled if OS is going to update itself.		
Delayed POST (PEI phase)	Disabled	Optimal Default, Failsafe Default
	Enabled	
Enabled - Robot holds BIOS from starting POST, right after power on. This allows BIOS POST to start with stable power or start after system is physically warmed-up. Note: Robot does this before 'Send watch dog'.		

Options Summary		
Delayed POST (DXE phase)	Disabled	Optimal Default, Failsafe Default
	Enabled	
Enabled - Robot holds BIOS before POST completion. This allows BIOS POST to start with stable power or start after system is physically warmed-up. Note: Robot does this after 'Send watch dog before BIOS POST'.		
Reset system once	Disabled	Optimal Default, Failsafe Default
	Enabled	
Enabled - Robot resets system for one time on each boot. This will send a soft or hard reset to onboard devices, thus puts devices to more stable state.		

3.5 Setup Submenu: System I/O



3.5.1 PCI Express Configuration

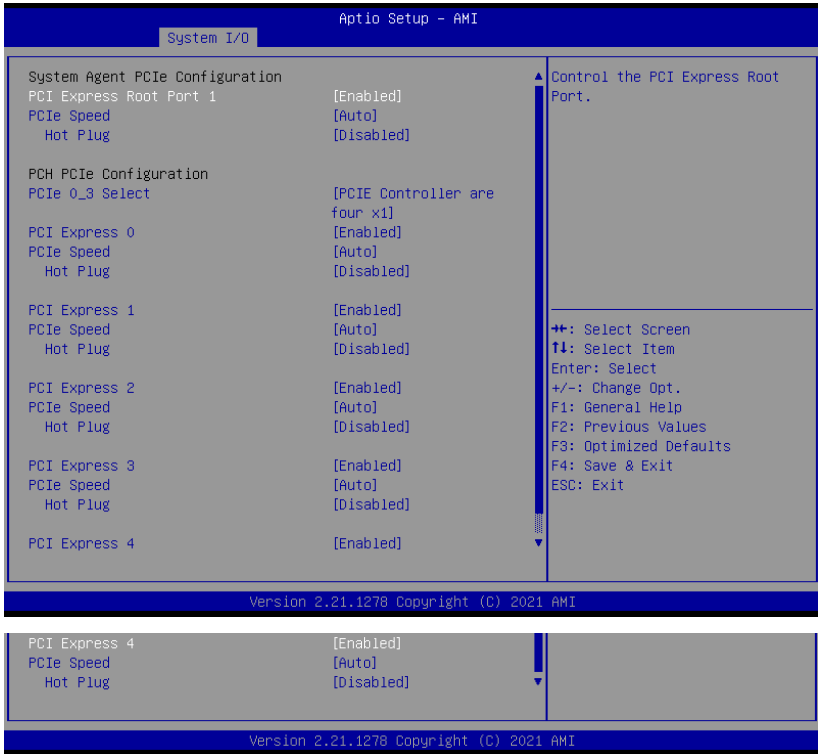

Options Summary		
PCI Express Root Port 1	Disabled	
	Enabled	Optimal Default, Failsafe Default
Control the PCI Express Root Port.		
PCIe Speed	Auto	Optimal Default, Failsafe Default
	Gen1	
	Gen2	
	Gen3	
	Gen4	
Configure PCIe Speed		
Hot Plug	Disabled	Optimal Default, Failsafe Default
	Enabled	
PCI Express Hot Plug Enable/Disable		

Options Summary		
PCIe 0_3 Select	PCIe Controller are four x1	Optimal Default, Failsafe Default
	PCIe Controller are one x2 and two x1	
	PCIe Controller are two x2	
	PCIe Controller is one x4	
PCIe Controller Selection		
PCI Express 0	Disable	
	Enable	Optimal Default, Failsafe Default
Control the PCI Express Root Port.		
PCIe Speed	Auto	Optimal Default, Failsafe Default
	Gen1	
	Gen2	
	Gen3	
Configure PCIe Speed		
Hot Plug	Disabled	Optimal Default, Failsafe Default
	Enabled	
PCI Express Hot Plug Enable/Disable		
PCI Express 1	Disable	
	Enable	Optimal Default, Failsafe Default
Control the PCI Express Root Port.		
PCIe Speed	Auto	Optimal Default, Failsafe Default
	Gen1	
	Gen2	
	Gen3	
Configure PCIe Speed		
Hot Plug	Disabled	Optimal Default, Failsafe Default
	Enabled	
PCI Express Hot Plug Enable/Disable		
PCI Express 2	Disable	
	Enable	Optimal Default, Failsafe Default
Control the PCI Express Root Port.		
PCIe Speed	Auto	Optimal Default, Failsafe Default
	Gen1	
	Gen2	
	Gen3	
Configure PCIe Speed		
Hot Plug	Disabled	Optimal Default, Failsafe Default
	Enabled	
PCI Express Hot Plug Enable/Disable		

Options Summary		
PCI Express 3	Disable	
	Enable	Optimal Default, Failsafe Default
Control the PCI Express Root Port.		
PCIe Speed	Auto	Optimal Default, Failsafe Default
	Gen1	
	Gen2	
	Gen3	
Configure PCIe Speed		
Hot Plug	Disabled	Optimal Default, Failsafe Default
	Enabled	
PCI Express Hot Plug Enable/Disable		
PCI Express 4	Disable	
	Enable	Optimal Default, Failsafe Default
Control the PCI Express Root Port.		
PCIe Speed	Auto	Optimal Default, Failsafe Default
	Gen1	
	Gen2	
	Gen3	
Configure PCIe Speed		
Hot Plug	Disabled	Optimal Default, Failsafe Default
	Enabled	
PCI Express Hot Plug Enable/Disable		

3.5.2 Storage Configuration

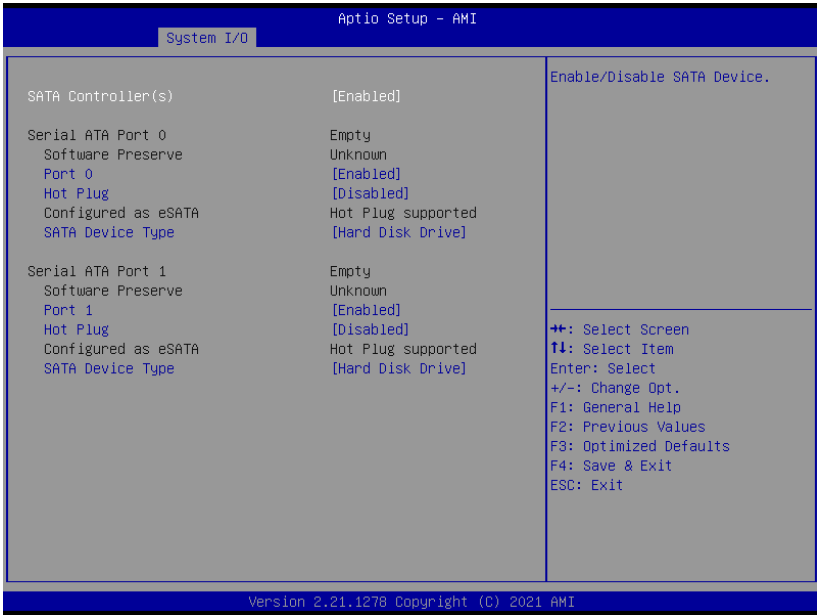

Options Summary		
SATA Controller(s)	Enabled	Optimal Default, Failsafe Default
	Disabled	
Enable/Disable SATA Device.		
Port 0	Disabled	
	Enabled	Optimal Default, Failsafe Default
Enable or Disable SATA Port		
Hot Plug	Disabled	Optimal Default, Failsafe Default
	Enabled	
Designates this port as Hot Pluggable		
SATA Device Type	Hard Disk Drive	Optimal Default, Failsafe Default
	Solid State Drive	
Identify the SATA port is connected to Solid State Drive or Hard Disk Drive		
Port 1	Disabled	
	Enabled	Optimal Default, Failsafe Default
Enable or Disable SATA Port		

Options Summary		
Hot Plug	Disabled	Optimal Default, Failsafe Default
	Enabled	
Designates this port as Hot Pluggable		
SATA Device Type	Hard Disk Drive	Optimal Default, Failsafe Default
	Solid State Drive	
Identify the SATA port is connected to Solid State Drive or Hard Disk Drive		

3.5.3 HD Audio Configuration

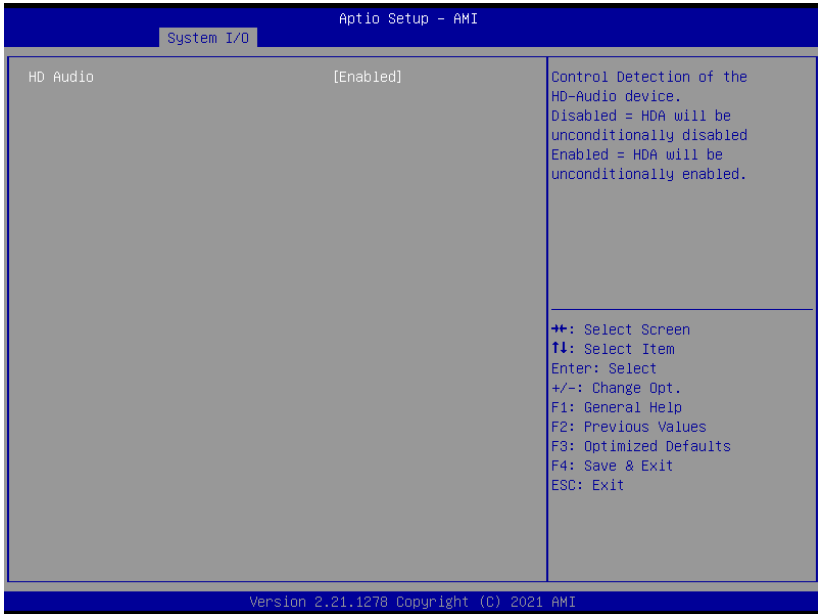

Options Summary		
HD Audio	Disabled	Optimal Default, Failsafe Default
	Enabled	
Control Detection of the HD-Audio device. Disabled = HDA will be unconditionally disabled Enabled = HDA will be unconditionally enabled.		

3.5.4 Digital IO Port Configuration



Options Summary		
GPI*	Input	Optimal Default, Failsafe Default
	Output	
Set DIO as Input or Output		
GPO*	Input	Optimal Default, Failsafe Default
	Output	
Set DIO as Input or Output		
Output Level	Low	Optimal Default, Failsafe Default
	High	
Set output level when DIO pin is output		

3.5.5 Legacy Logical Devices Configuration



3.5.5.1 Serial Port1 Configuration

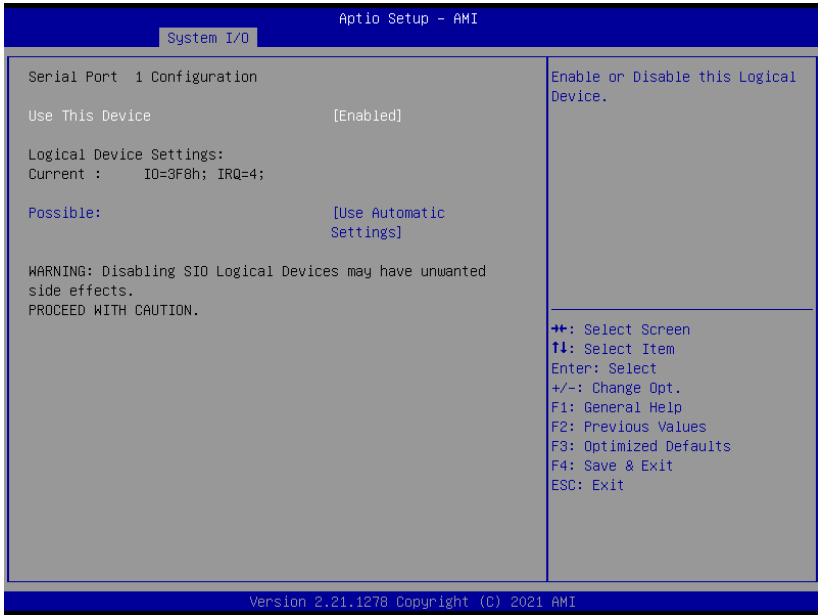

Options Summary		
Use This Device	Disabled	Optimal Default, Failsafe Default
	Enabled	
Enable or Disable this Logical Device.		
Possible:	Use Automatic Settings	Optimal Default, Failsafe Default
	IO=3F8h; IRQ=4; DMA;	
	IO=2C8h; IRQ=11; DMA;	
Allows the user to change the device resource settings. New settings will be reflected on this setup page after system restarts.		

3.5.5.2 Serial Port2 Configuration

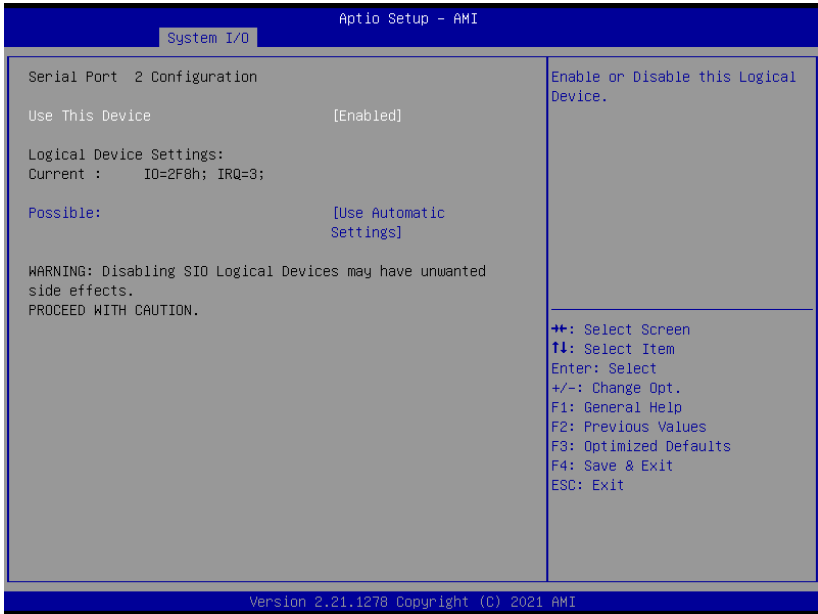

Options Summary		
Use This Device	Disabled	Optimal Default, Failsafe Default
	Enabled	
Enable or Disable this Logical Device.		
Possible:	Use Automatic Settings	Optimal Default, Failsafe Default
	IO=2F8h; IRQ=3 DMA;	
	IO=2D8h; IRQ=10; DMA;	
Allows the user to change the device resource settings. New settings will be reflected on this setup page after system restarts.		

3.5.6 Serial Port Console Redirection

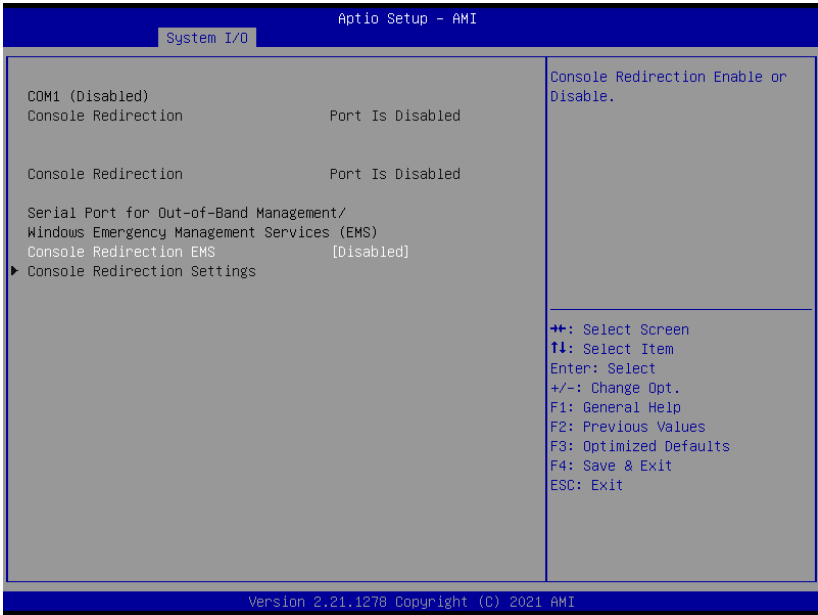

Options Summary		
Console Redirection	Disabled	Optimal Default, Failsafe Default
EMS	Enabled	
Console Redirection Enable or Disable.		

3.6 Setup Submenu: Security

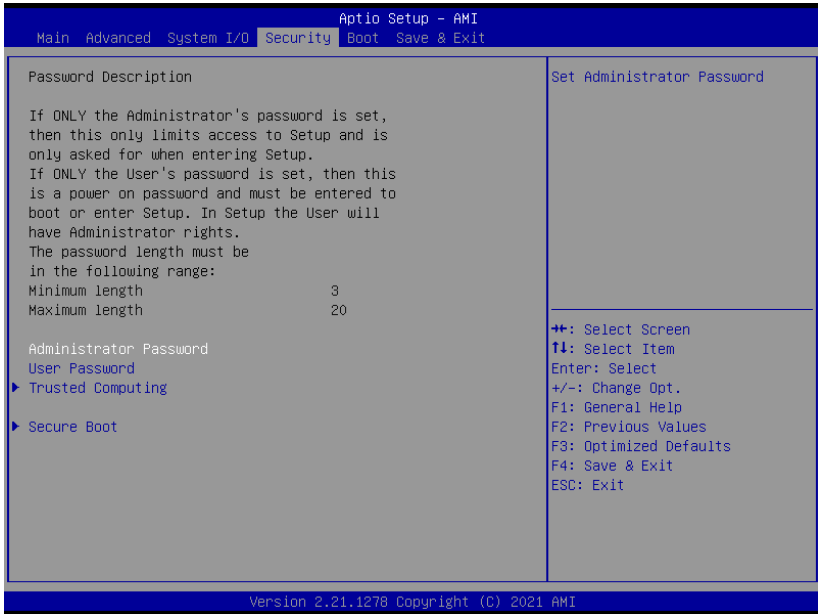

Change Administrator/User Password

You can set an Administrator password. If you set an Administrator password, you can then set a User password. User passwords do not have access to many of the features in the Setup utility.

Select the password you want to set and press <Enter>. A dialog box will appear which lets you set the password. Passwords must be between 3 and 20 letters or numbers. Press <Enter> and re-enter the password into the next dialog box that appears. Press <Enter> after you have retyped it correctly. The password is required at boot time, or when the user enters the Setup utility.

Remove Password

Highlight this item and type in the current password. At the next dialog box press <Enter> to disable password protection.

3.6.1 Trusted Computing

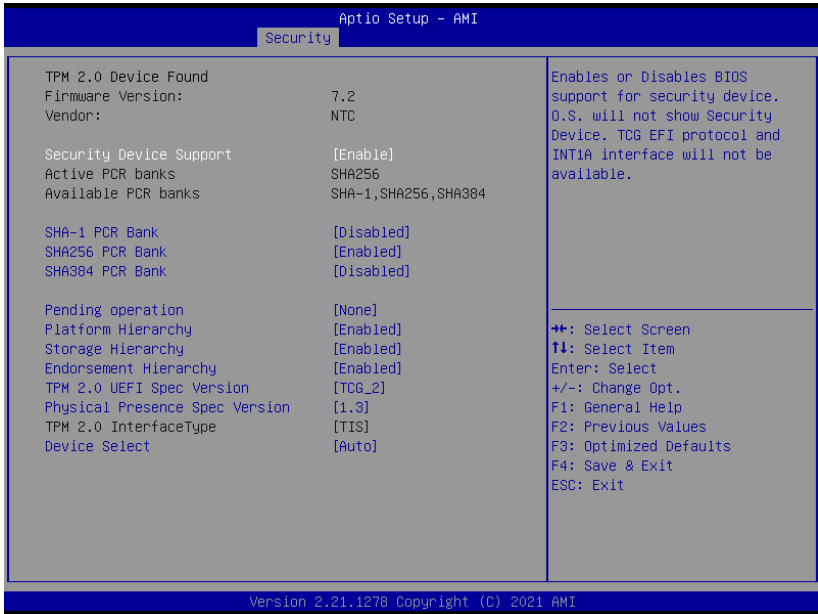

Options Summary		
Security Device Support	Disable	Optimal Default, Failsafe Default
	Enable	
Enables or Disables BIOS support for security device. O.S. will not show Security Device. TGU EFI protocol and INT1A interface will not be available.		
SHA-1 PCR Bank	Disabled	Optimal Default, Failsafe Default
	Enabled	
Enable or Disable SHA-1 PCR Bank		
SHA256 PCR Bank	Disabled	
	Enabled	Optimal Default, Failsafe Default
Enable or Disable SHA256 PCR Bank		
SHA384 PCR Bank	Disabled	Optimal Default, Failsafe Default
	Enabled	
Enable or Disable SHA384 PCR Bank		

Table Continues on Next Page...

Options Summary		
Pending operation	None	Optimal Default, Failsafe Default
	TPM Clear	
Schedule an Operation for the Security Device. Note: Your Computer will reboot during restart in order to change State of Security Device.		
Platform Hierarchy	Disabled	
	Enabled	Optimal Default, Failsafe Default
Enable or Disable Platform Hierarchy		
Storage Hierarchy	Disabled	
	Enabled	Optimal Default, Failsafe Default
Enable or Disable Storage Hierarchy		
Endorsement Hierarchy	Disabled	
	Enabled	Optimal Default, Failsafe Default
Enable or Disable Endorsement Hierarchy		
TPM 2.0 UEFI Spec Version	TCG_1_2	
	TCG_2	Optimal Default, Failsafe Default
Select the TCG2 Spec Version Support, TCG_1_2: the Compatible mode for Win8/Win10, TCG_2: Support new TCG2 protocol and event format for win10 or later		
Physical Presence Spec Version	1.2	
	1.3	Optimal Default, Failsafe Default
Select to Tell O.S. to support PPI Spec Version 1.2 or 1.3. Note some HCK tests might not support 1.3.		
Device Select	TPM 1.2	
	TPM 2.0	
	Auto	Optimal Default, Failsafe Default
TPM 1.2 will restrict support to TPM 1.2 devices, TPM 2.0 will restrict support to TPM 2.0 devices, Auto will support both with the default set to TPM 2.0 devices if not found, TPM 1.2 devices will be enumerated		

3.6.2 Secure Boot

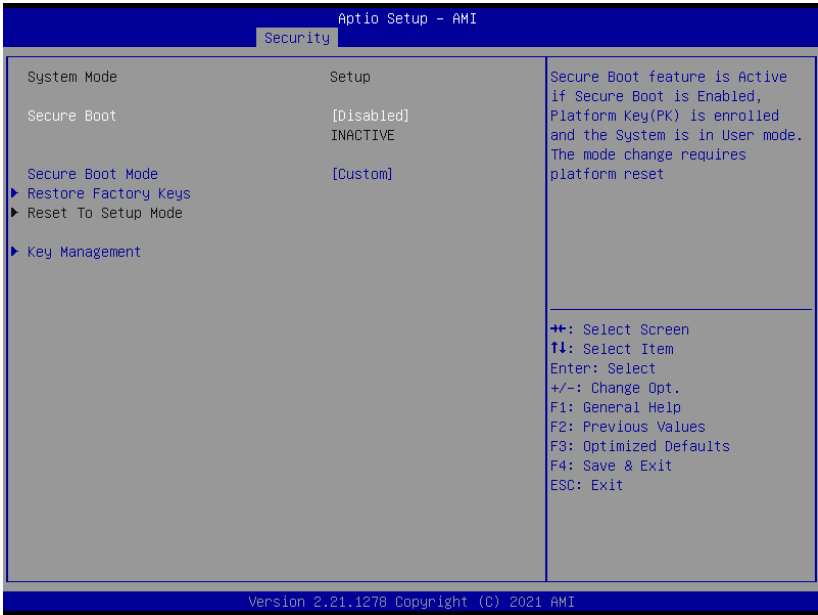

Options Summary		
Secure Boot	Disabled	Optimal Default, Failsafe Default
	Enabled	
Secure Boot feature is Active if Secure Boot is Enabled, Platform Key (PK) is enrolled and the System is in User mode. The mode change requires platform reset		
Secure Boot Mode	Standard	Optimal Default, Failsafe Default
	Custom	
Secure Boot mode options: Standard or Custom. In Custom mode, Secure Boot Policy variables can be configured by a physically present user without full authentication		

3.7 Setup Submenu: Boot

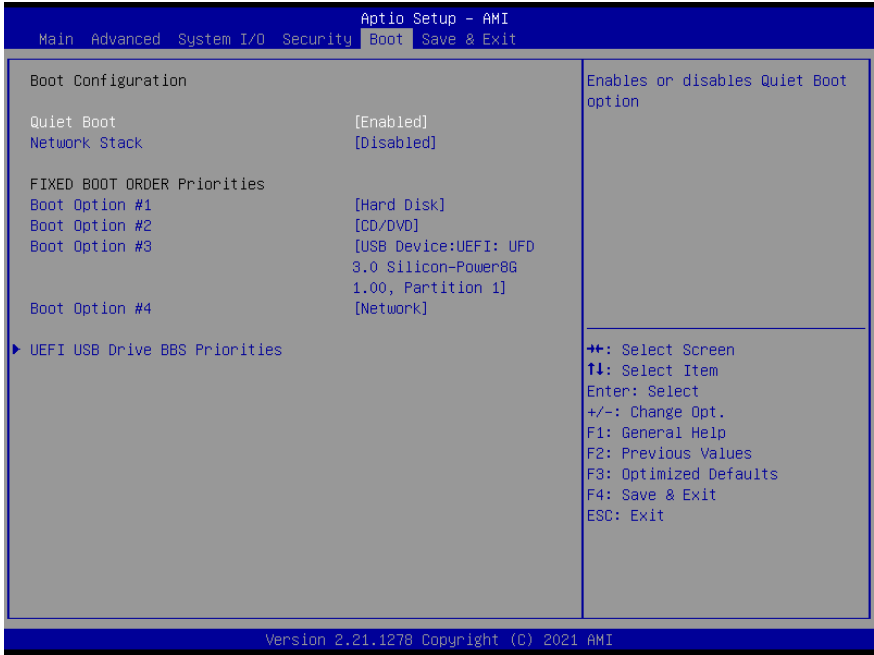

Options Summary		
Quiet Boot	Disabled	Optimal Default, Failsafe Default
	Enabled	
Enables or Disables Quite Boot option		
Network Stack	Disabled	Optimal Default, Failsafe Default
	UEFI	
Enable/Disable UEFI Network Stack		

3.8 Setup submenu: Save & Exit

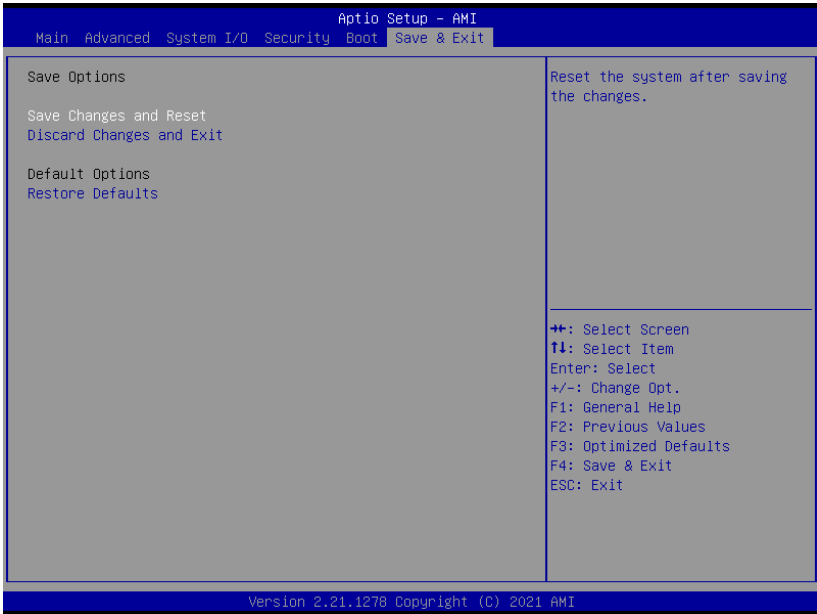

Chapter 4

Drivers Installation

4.1 Drivers Download and Installation

Drivers for the COM-TGUC6 can be downloaded from the product page on the AAEON website by following this link:

<https://www.aaeon.com/en/p/com-express-cpu-modules-com-tguc6>

Download the driver(s) you need and follow the steps below to install them.

Audio Driver (Windows 10)

1. Open the folder where you unzipped the **Audio Drivers**
2. Run the **Setup.exe** in the folder
3. Follow the instructions
4. Drivers will be installed automatically

Chipset Driver (Windows 10)

1. Open the folder where you unzipped the **Chipset Drivers**
2. Run the **SetupChipset.exe** file in the folder
3. Follow the instructions
4. Drivers will be installed automatically

Graphics Driver (Windows 10)

1. Open the folder where you unzipped the **Graphics Drivers**
2. Run the **igxpin.exe** file in the folder
3. Follow the instructions
4. Drivers will be installed automatically
5. Refer to the ReadMe.txt for any assistance.

LAN Drivers (Windows 10)

1. Open the folder where you unzipped the **LAN Drivers**
2. Read the ReadMe.txt file before proceeding. **Caution:** Be sure to install the driver package before installing the Intel® PROSet package.
3. Open the **Wired_driver_26.3_x64** folder
4. Run the **Wired_driver_26.3_x64.exe** file in the folder
5. Follow the instructions, drivers will be installed automatically.
6. After installing the LAN driver, install Intel® PROSet package (optional)
7. Open the **Wired_PROSet_26.3_x64** folder
8. Run the **Wired_PROSet_26.3_x64.exe** file in the folder
9. Follow the instructions
10. Drivers will be installed automatically

Intel® Active Management Technology Drivers (Windows 10)

1. Open the folder where you unzipped the **Intel AMT Drivers**
2. Drivers must be installed manually, refer to Windows guidance to complete steps.

Intel® Management Engine Interface Drivers (Windows 10)

1. Open the folder where you unzipped the **Intel MEI Drivers**
2. Drivers must be installed manually, refer to Windows guidance to complete steps.

Peripheral Driver (Linux)

1. Open the folder where you unzipped the **Peripheral Drivers**
2. Follow the instructions contained within the user guides to install the related drivers.

Appendix A

Watchdog Timer

A.1 Watchdog Timer Initial Program

Table 1: Embedded BRAM relative register table

	Default Value	Note
Index	0x284(Note1)	BRAM Index Register
Data	0x285(Note2)	BRAM Data Register
Logical Device Number	0xA8(Note3)	Watch dog Logical Device Number
Function and Device Number	0x00(Note4)	Watch dog Function/Device Number

Table 2: Watchdog relative register table

	Option Register	BitNum	Value	Note
Timer Counter	0x00(Note5)		(Note10)	Time of watchdog timer (0~255)
Counting Unit	0x01(Note6)	0(Note7)	0(Note11)	Select time unit. 0: second 1: minute
Watchdog RST pulse width	0x01(Note8)	[3:2](Note9)	0(Note12)	0: 20ms 1: 60ms 2: 100ms 3: 250ms

```

*****
// Embedded BRAM relative definition (Please reference to Table 1)
#define byte EcBRAMIndex //This parameter is represented from Note1
#define byte EcBRAMData //This parameter is represented from Note2
#define byte BRAMLDRReg //This parameter is represented from Note3
#define byte BRAMFnDataReg //This parameter is represented from Note4
#define void EcBRAMWriteByte(byte Offset, byte Value);
#define byte EcBRAMReadByte(byte Offset);
#define void IOWriteByte(byte Offset, byte Value);
#define byte IOReadByte(byte Offset);
// WatchDog relative definition (Please reference to Table 2)
#define byte TimerReg //This parameter is represented from Note5
#define byte TimerVal // This parameter is represented from Note10
#define byte UnitReg //This parameter is represented from Note6
#define byte UnitBit //This parameter is represented from Note7
#define byte UnitVal //This parameter is represented from Note11
#define byte RSTReg //This parameter is represented from Note8
#define byte RSTBit //This parameter is represented from Note9
#define byte RSTVal //This parameter is represented from Note12
*****

```

```
*****
VOID Main() {
    // Procedure : AaeonWDTConfig
    // (byte)Timer : Time of WDT timer.(0x00~0xFF)
    // (boolean)Unit : Select time unit(0: second, 1: minute).
    AaeonWDTConfig();

    // Procedure : AaeonWDTEnable
    // This procedure will enable the WDT counting.
    AaeonWDTEnable();
}
*****
```

```

*****
// Procedure : AaeonWDTEnable
VOID AaeonWDTEnable (){
    WDTEnableDisable(1);
}

// Procedure : AaeonWDTConfig
VOID AaeonWDTConfig (){
    // Disable WDT counting
    WDTEnableDisable(0);
    // WDT relative parameter setting
    WDTParameterSetting();
}

VOID WDTEnableDisable(byte Value){
    ECBRAMWriteByte(TimerReg , Value);
}

VOID WDTParameterSetting(){
    Byte TempByte;

    // Watchdog Timer counter setting
    ECBRAMWriteByte(TimerReg , TimerVal);
    // WDT counting unit setting
    TempByte = ECBRAMReadByte(UnitReg);
    TempByte |= (UnitVal << UnitBit);
    ECBRAMWriteByte(UnitReg , TempByte);
    // WDT RST pulse width setting
    TempByte = ECBRAMReadByte(RSTReg);
    TempByte |= (RSTVal << RSTBit);
    ECBRAMWriteByte(RSTReg , TempByte);
}
*****

```



```

*****
VOID ECBRAMWriteByte(byte OPReg, byte OPBit, byte Value){
    IOWriteByte(EcBRAMIndex, 0x10);
    IOWriteByte(EcBRAMData, BRAMLDNReg);
    IOWriteByte(EcBRAMIndex, 0x11);
    IOWriteByte(EcBRAMData, BRAMFnDataReg);

    IOWriteByte(EcBRAMIndex, 0x13 + OPReg);
    IOWriteByte(EcBRAMData, Value);

    IOWriteByte(EcBRAMIndex, 0x12);
    IOWriteByte(EcBRAMData, 0x30);        //Write start
}

Byte ECBRAMReadByte(byte OPReg){
    IOWriteByte(EcBRAMIndex, 0x10);
    IOWriteByte(EcBRAMData, BRAMLDNReg);
    IOWriteByte(EcBRAMIndex, 0x11);
    IOWriteByte(EcBRAMData, BRAMFnDataReg);

    IOWriteByte(EcBRAMIndex, 0x12);
    IOWriteByte(EcBRAMData, 0x10);        //Read start

    IOWriteByte(EcBRAMIndex, 0x13 + OPReg);
    Return      IOReadByte(EcBRAMData, Value);
}
*****

```







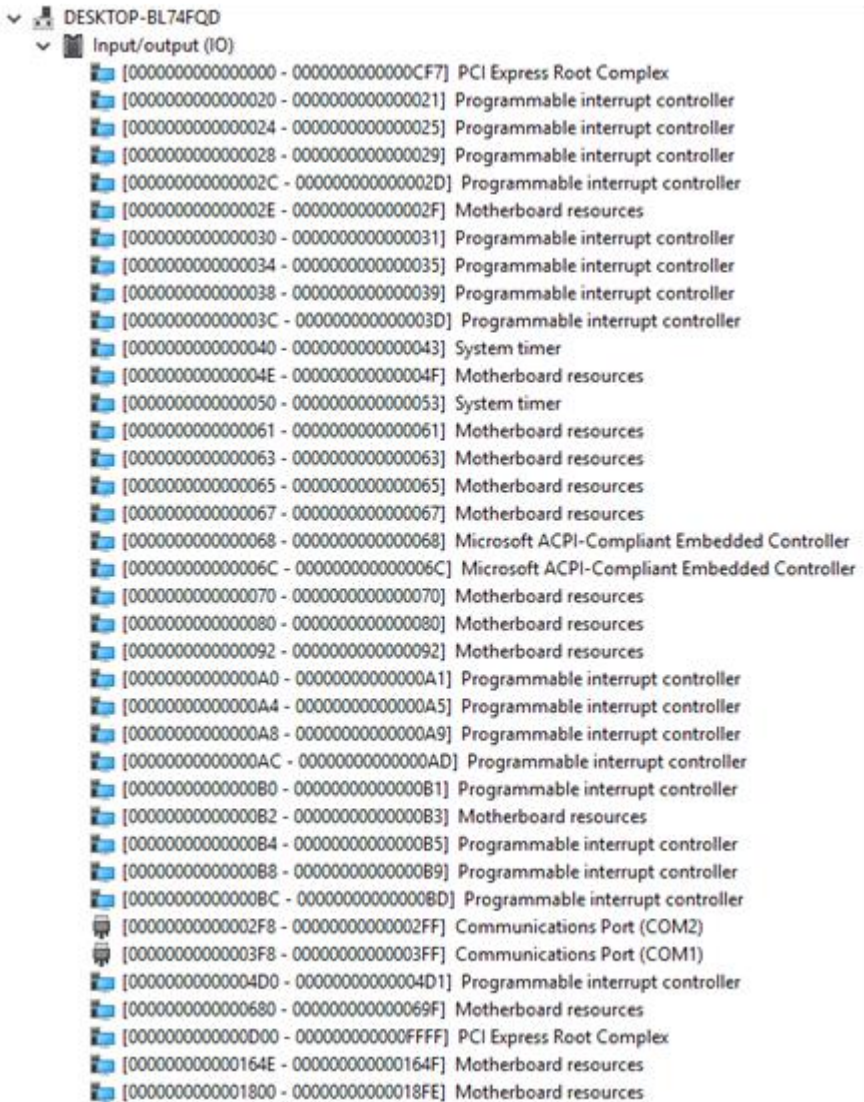

Appendix B

I/O Information

B.1 I/O Address Map



Address Range	Device Description
[0000000000000000 - 0000000000000CF7]	PCI Express Root Complex
[0000000000000020 - 0000000000000021]	Programmable interrupt controller
[0000000000000024 - 0000000000000025]	Programmable interrupt controller
[0000000000000028 - 0000000000000029]	Programmable interrupt controller
[000000000000002C - 000000000000002D]	Programmable interrupt controller
[000000000000002E - 000000000000002F]	Motherboard resources
[0000000000000030 - 0000000000000031]	Programmable interrupt controller
[0000000000000034 - 0000000000000035]	Programmable interrupt controller
[0000000000000038 - 0000000000000039]	Programmable interrupt controller
[000000000000003C - 000000000000003D]	Programmable interrupt controller
[0000000000000040 - 0000000000000043]	System timer
[000000000000004E - 000000000000004F]	Motherboard resources
[0000000000000050 - 0000000000000053]	System timer
[0000000000000061 - 0000000000000061]	Motherboard resources
[0000000000000063 - 0000000000000063]	Motherboard resources
[0000000000000065 - 0000000000000065]	Motherboard resources
[0000000000000067 - 0000000000000067]	Motherboard resources
[0000000000000068 - 0000000000000068]	Microsoft ACPI-Compliant Embedded Controller
[000000000000006C - 000000000000006C]	Microsoft ACPI-Compliant Embedded Controller
[0000000000000070 - 0000000000000070]	Motherboard resources
[0000000000000080 - 0000000000000080]	Motherboard resources
[0000000000000092 - 0000000000000092]	Motherboard resources
[00000000000000A0 - 00000000000000A1]	Programmable interrupt controller
[00000000000000A4 - 00000000000000A5]	Programmable interrupt controller
[00000000000000A8 - 00000000000000A9]	Programmable interrupt controller
[00000000000000AC - 00000000000000AD]	Programmable interrupt controller
[00000000000000B0 - 00000000000000B1]	Programmable interrupt controller
[00000000000000B2 - 00000000000000B3]	Motherboard resources
[00000000000000B4 - 00000000000000B5]	Programmable interrupt controller
[00000000000000B8 - 00000000000000B9]	Programmable interrupt controller
[00000000000000BC - 00000000000000BD]	Programmable interrupt controller
[00000000000002F8 - 00000000000002FF]	Communications Port (COM2)
[00000000000003F8 - 00000000000003FF]	Communications Port (COM1)
[00000000000004D0 - 00000000000004D1]	Programmable interrupt controller
[0000000000000680 - 000000000000069F]	Motherboard resources
[0000000000000D00 - 0000000000000FFF]	PCI Express Root Complex
[000000000000164E - 000000000000164F]	Motherboard resources
[0000000000001800 - 00000000000018FE]	Motherboard resources

	[0000000000001800 - 00000000000018FE]	Motherboard resources
	[0000000000001854 - 0000000000001857]	Motherboard resources
	[0000000000002000 - 00000000000020FE]	Motherboard resources
	[0000000000003000 - 000000000000303F]	Intel(R) Iris(R) Xe Graphics
	[0000000000003060 - 000000000000307F]	Standard SATA AHCI Controller
	[0000000000003080 - 0000000000003083]	Standard SATA AHCI Controller
	[0000000000003090 - 0000000000003097]	Standard SATA AHCI Controller
	[000000000000EFA0 - 000000000000EFBF]	Intel(R) SMBus - A0A3

B.2 Memory Address Map

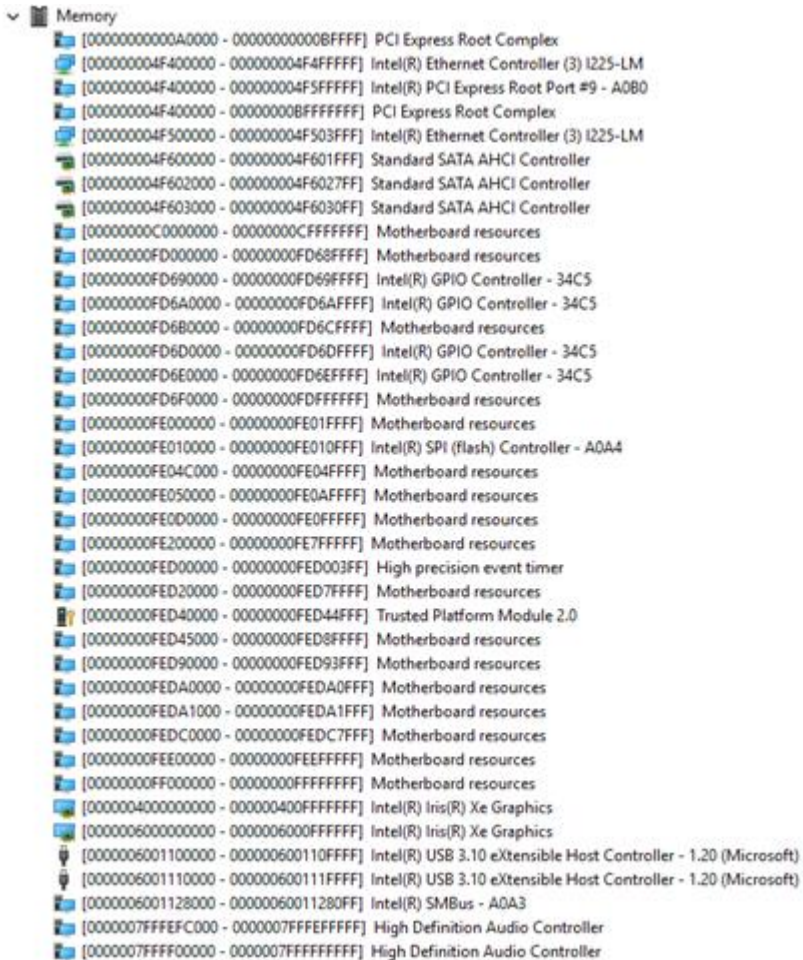

Address Range	Device Name
[00000000000A0000 - 00000000000BFFFF]	PCI Express Root Complex
[000000004F400000 - 000000004F4FFFFF]	Intel(R) Ethernet Controller (3) I225-LM
[000000004F400000 - 000000004F5FFFFF]	Intel(R) PCI Express Root Port #9 - A0B0
[000000004F400000 - 00000000BFFFFFFF]	PCI Express Root Complex
[000000004F500000 - 000000004F503FFF]	Intel(R) Ethernet Controller (3) I225-LM
[000000004F600000 - 000000004F601FFF]	Standard SATA AHCI Controller
[000000004F602000 - 000000004F6027FF]	Standard SATA AHCI Controller
[000000004F603000 - 000000004F6030FF]	Standard SATA AHCI Controller
[00000000C0000000 - 00000000CFFFFFFF]	Motherboard resources
[00000000FD000000 - 00000000FD68FFFF]	Motherboard resources
[00000000FD690000 - 00000000FD69FFFF]	Intel(R) GPIO Controller - 34C5
[00000000FD6A0000 - 00000000FD6AFFFF]	Intel(R) GPIO Controller - 34C5
[00000000FD6B0000 - 00000000FD6CFFFF]	Motherboard resources
[00000000FD6D0000 - 00000000FD6DFFFF]	Intel(R) GPIO Controller - 34C5
[00000000FD6E0000 - 00000000FD6EFFFF]	Intel(R) GPIO Controller - 34C5
[00000000FD6F0000 - 00000000FD6FFFFF]	Motherboard resources
[00000000FE000000 - 00000000FE01FFFF]	Motherboard resources
[00000000FE010000 - 00000000FE010FFF]	Intel(R) SPI (flash) Controller - A0A4
[00000000FE04C000 - 00000000FE04FFFF]	Motherboard resources
[00000000FE050000 - 00000000FE0AFFFF]	Motherboard resources
[00000000FE0D0000 - 00000000FE0FFFFF]	Motherboard resources
[00000000FE200000 - 00000000FE7FFFFF]	Motherboard resources
[00000000FED00000 - 00000000FED003FF]	High precision event timer
[00000000FED20000 - 00000000FED7FFFF]	Motherboard resources
[00000000FED40000 - 00000000FED44FFF]	Trusted Platform Module 2.0
[00000000FED45000 - 00000000FED8FFFF]	Motherboard resources
[00000000FED90000 - 00000000FED93FFF]	Motherboard resources
[00000000FEDA0000 - 00000000FEDA0FFF]	Motherboard resources
[00000000FEDA1000 - 00000000FEDA1FFF]	Motherboard resources
[00000000FEDC0000 - 00000000FEDC7FFF]	Motherboard resources
[00000000FEE00000 - 00000000FEEFFFFF]	Motherboard resources
[00000000FF000000 - 00000000FFFFFFFF]	Motherboard resources
[0000000400000000 - 0000000400FFFFFF]	Intel(R) Iris(R) Xe Graphics
[0000000600000000 - 0000000600FFFFFF]	Intel(R) Iris(R) Xe Graphics
[0000000600110000 - 0000000600110FFFFF]	Intel(R) USB 3.10 eXtensible Host Controller - 1.20 (Microsoft)
[0000000600111000 - 0000000600111FFFFF]	Intel(R) USB 3.10 eXtensible Host Controller - 1.20 (Microsoft)
[00000006001128000 - 000000060011280FFF]	Intel(R) SMBus - A0A3
[00000007FFFEC000 - 00000007FFFEEFFFFF]	High Definition Audio Controller
[00000007FFFF0000 - 00000007FFFFFFFFFF]	High Definition Audio Controller







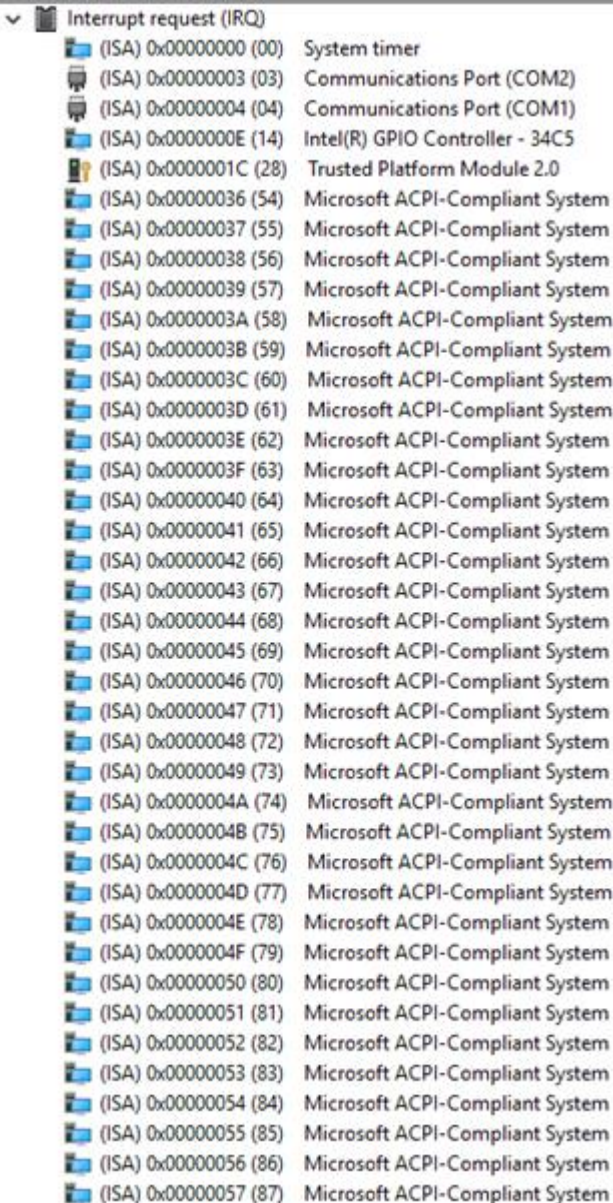

































B.3 Large Memory Address Map









































- ▼  Large Memory
 -  [0000004000000000 - 0000007FFFFFFFFF] PCI Express Root Complex
 -









































B.4 IRQ Mapping Chart



















































































Device Name	IRQ
System timer	(ISA) 0x00000000 (00)
Communications Port (COM2)	(ISA) 0x00000003 (03)
Communications Port (COM1)	(ISA) 0x00000004 (04)
Intel(R) GPIO Controller - 34C5	(ISA) 0x0000000E (14)
Trusted Platform Module 2.0	(ISA) 0x0000001C (28)
Microsoft ACPI-Compliant System	(ISA) 0x00000036 (54)
Microsoft ACPI-Compliant System	(ISA) 0x00000037 (55)
Microsoft ACPI-Compliant System	(ISA) 0x00000038 (56)
Microsoft ACPI-Compliant System	(ISA) 0x00000039 (57)
Microsoft ACPI-Compliant System	(ISA) 0x0000003A (58)
Microsoft ACPI-Compliant System	(ISA) 0x0000003B (59)
Microsoft ACPI-Compliant System	(ISA) 0x0000003C (60)
Microsoft ACPI-Compliant System	(ISA) 0x0000003D (61)
Microsoft ACPI-Compliant System	(ISA) 0x0000003E (62)
Microsoft ACPI-Compliant System	(ISA) 0x0000003F (63)
Microsoft ACPI-Compliant System	(ISA) 0x00000040 (64)
Microsoft ACPI-Compliant System	(ISA) 0x00000041 (65)
Microsoft ACPI-Compliant System	(ISA) 0x00000042 (66)
Microsoft ACPI-Compliant System	(ISA) 0x00000043 (67)
Microsoft ACPI-Compliant System	(ISA) 0x00000044 (68)
Microsoft ACPI-Compliant System	(ISA) 0x00000045 (69)
Microsoft ACPI-Compliant System	(ISA) 0x00000046 (70)
Microsoft ACPI-Compliant System	(ISA) 0x00000047 (71)
Microsoft ACPI-Compliant System	(ISA) 0x00000048 (72)
Microsoft ACPI-Compliant System	(ISA) 0x00000049 (73)
Microsoft ACPI-Compliant System	(ISA) 0x0000004A (74)
Microsoft ACPI-Compliant System	(ISA) 0x0000004B (75)
Microsoft ACPI-Compliant System	(ISA) 0x0000004C (76)
Microsoft ACPI-Compliant System	(ISA) 0x0000004D (77)
Microsoft ACPI-Compliant System	(ISA) 0x0000004E (78)
Microsoft ACPI-Compliant System	(ISA) 0x0000004F (79)
Microsoft ACPI-Compliant System	(ISA) 0x00000050 (80)
Microsoft ACPI-Compliant System	(ISA) 0x00000051 (81)
Microsoft ACPI-Compliant System	(ISA) 0x00000052 (82)
Microsoft ACPI-Compliant System	(ISA) 0x00000053 (83)
Microsoft ACPI-Compliant System	(ISA) 0x00000054 (84)
Microsoft ACPI-Compliant System	(ISA) 0x00000055 (85)
Microsoft ACPI-Compliant System	(ISA) 0x00000056 (86)
Microsoft ACPI-Compliant System	(ISA) 0x00000057 (87)









































 (ISA) 0x00000057 (87)	Microsoft ACPI-Compliant System
 (ISA) 0x00000058 (88)	Microsoft ACPI-Compliant System
 (ISA) 0x00000059 (89)	Microsoft ACPI-Compliant System
 (ISA) 0x0000005A (90)	Microsoft ACPI-Compliant System
 (ISA) 0x0000005B (91)	Microsoft ACPI-Compliant System
 (ISA) 0x0000005C (92)	Microsoft ACPI-Compliant System
 (ISA) 0x0000005D (93)	Microsoft ACPI-Compliant System
 (ISA) 0x0000005E (94)	Microsoft ACPI-Compliant System
 (ISA) 0x0000005F (95)	Microsoft ACPI-Compliant System
 (ISA) 0x00000060 (96)	Microsoft ACPI-Compliant System
 (ISA) 0x00000061 (97)	Microsoft ACPI-Compliant System
 (ISA) 0x00000062 (98)	Microsoft ACPI-Compliant System
 (ISA) 0x00000063 (99)	Microsoft ACPI-Compliant System
 (ISA) 0x00000064 (100)	Microsoft ACPI-Compliant System
 (ISA) 0x00000065 (101)	Microsoft ACPI-Compliant System
 (ISA) 0x00000066 (102)	Microsoft ACPI-Compliant System
 (ISA) 0x00000067 (103)	Microsoft ACPI-Compliant System
 (ISA) 0x00000068 (104)	Microsoft ACPI-Compliant System
 (ISA) 0x00000069 (105)	Microsoft ACPI-Compliant System
 (ISA) 0x0000006A (106)	Microsoft ACPI-Compliant System
 (ISA) 0x0000006B (107)	Microsoft ACPI-Compliant System
 (ISA) 0x0000006C (108)	Microsoft ACPI-Compliant System
 (ISA) 0x0000006D (109)	Microsoft ACPI-Compliant System
 (ISA) 0x0000006E (110)	Microsoft ACPI-Compliant System
 (ISA) 0x0000006F (111)	Microsoft ACPI-Compliant System
 (ISA) 0x00000070 (112)	Microsoft ACPI-Compliant System
 (ISA) 0x00000071 (113)	Microsoft ACPI-Compliant System
 (ISA) 0x00000072 (114)	Microsoft ACPI-Compliant System
 (ISA) 0x00000073 (115)	Microsoft ACPI-Compliant System
 (ISA) 0x00000074 (116)	Microsoft ACPI-Compliant System
 (ISA) 0x00000075 (117)	Microsoft ACPI-Compliant System
 (ISA) 0x00000076 (118)	Microsoft ACPI-Compliant System
 (ISA) 0x00000077 (119)	Microsoft ACPI-Compliant System
 (ISA) 0x00000078 (120)	Microsoft ACPI-Compliant System
 (ISA) 0x00000079 (121)	Microsoft ACPI-Compliant System
 (ISA) 0x0000007A (122)	Microsoft ACPI-Compliant System
 (ISA) 0x0000007B (123)	Microsoft ACPI-Compliant System
 (ISA) 0x0000007C (124)	Microsoft ACPI-Compliant System
 (ISA) 0x0000007D (125)	Microsoft ACPI-Compliant System
 (ISA) 0x0000007E (126)	Microsoft ACPI-Compliant System









































 (ISA) 0x0000007E (126)	Microsoft ACPI-Compliant System
 (ISA) 0x0000007F (127)	Microsoft ACPI-Compliant System
 (ISA) 0x00000080 (128)	Microsoft ACPI-Compliant System
 (ISA) 0x00000081 (129)	Microsoft ACPI-Compliant System
 (ISA) 0x00000082 (130)	Microsoft ACPI-Compliant System
 (ISA) 0x00000083 (131)	Microsoft ACPI-Compliant System
 (ISA) 0x00000084 (132)	Microsoft ACPI-Compliant System
 (ISA) 0x00000085 (133)	Microsoft ACPI-Compliant System
 (ISA) 0x00000086 (134)	Microsoft ACPI-Compliant System
 (ISA) 0x00000087 (135)	Microsoft ACPI-Compliant System
 (ISA) 0x00000088 (136)	Microsoft ACPI-Compliant System
 (ISA) 0x00000089 (137)	Microsoft ACPI-Compliant System
 (ISA) 0x0000008A (138)	Microsoft ACPI-Compliant System
 (ISA) 0x0000008B (139)	Microsoft ACPI-Compliant System
 (ISA) 0x0000008C (140)	Microsoft ACPI-Compliant System
 (ISA) 0x0000008D (141)	Microsoft ACPI-Compliant System
 (ISA) 0x0000008E (142)	Microsoft ACPI-Compliant System
 (ISA) 0x0000008F (143)	Microsoft ACPI-Compliant System
 (ISA) 0x00000090 (144)	Microsoft ACPI-Compliant System
 (ISA) 0x00000091 (145)	Microsoft ACPI-Compliant System
 (ISA) 0x00000092 (146)	Microsoft ACPI-Compliant System
 (ISA) 0x00000093 (147)	Microsoft ACPI-Compliant System
 (ISA) 0x00000094 (148)	Microsoft ACPI-Compliant System
 (ISA) 0x00000095 (149)	Microsoft ACPI-Compliant System
 (ISA) 0x00000096 (150)	Microsoft ACPI-Compliant System
 (ISA) 0x00000097 (151)	Microsoft ACPI-Compliant System
 (ISA) 0x00000098 (152)	Microsoft ACPI-Compliant System
 (ISA) 0x00000099 (153)	Microsoft ACPI-Compliant System
 (ISA) 0x0000009A (154)	Microsoft ACPI-Compliant System
 (ISA) 0x0000009B (155)	Microsoft ACPI-Compliant System
 (ISA) 0x0000009C (156)	Microsoft ACPI-Compliant System
 (ISA) 0x0000009D (157)	Microsoft ACPI-Compliant System
 (ISA) 0x0000009E (158)	Microsoft ACPI-Compliant System
 (ISA) 0x0000009F (159)	Microsoft ACPI-Compliant System
 (ISA) 0x000000A0 (160)	Microsoft ACPI-Compliant System
 (ISA) 0x000000A1 (161)	Microsoft ACPI-Compliant System
 (ISA) 0x000000A2 (162)	Microsoft ACPI-Compliant System
 (ISA) 0x000000A3 (163)	Microsoft ACPI-Compliant System
 (ISA) 0x000000A4 (164)	Microsoft ACPI-Compliant System
 (ISA) 0x000000A5 (165)	Microsoft ACPI-Compliant System









































 (ISA) 0x000000A5 (165)	Microsoft ACPI-Compliant System
 (ISA) 0x000000A6 (166)	Microsoft ACPI-Compliant System
 (ISA) 0x000000A7 (167)	Microsoft ACPI-Compliant System
 (ISA) 0x000000A8 (168)	Microsoft ACPI-Compliant System
 (ISA) 0x000000A9 (169)	Microsoft ACPI-Compliant System
 (ISA) 0x000000AA (170)	Microsoft ACPI-Compliant System
 (ISA) 0x000000AB (171)	Microsoft ACPI-Compliant System
 (ISA) 0x000000AC (172)	Microsoft ACPI-Compliant System
 (ISA) 0x000000AD (173)	Microsoft ACPI-Compliant System
 (ISA) 0x000000AE (174)	Microsoft ACPI-Compliant System
 (ISA) 0x000000AF (175)	Microsoft ACPI-Compliant System
 (ISA) 0x000000B0 (176)	Microsoft ACPI-Compliant System
 (ISA) 0x000000B1 (177)	Microsoft ACPI-Compliant System
 (ISA) 0x000000B2 (178)	Microsoft ACPI-Compliant System
 (ISA) 0x000000B3 (179)	Microsoft ACPI-Compliant System
 (ISA) 0x000000B4 (180)	Microsoft ACPI-Compliant System
 (ISA) 0x000000B5 (181)	Microsoft ACPI-Compliant System
 (ISA) 0x000000B6 (182)	Microsoft ACPI-Compliant System
 (ISA) 0x000000B7 (183)	Microsoft ACPI-Compliant System
 (ISA) 0x000000B8 (184)	Microsoft ACPI-Compliant System
 (ISA) 0x000000B9 (185)	Microsoft ACPI-Compliant System
 (ISA) 0x000000BA (186)	Microsoft ACPI-Compliant System
 (ISA) 0x000000BB (187)	Microsoft ACPI-Compliant System
 (ISA) 0x000000BC (188)	Microsoft ACPI-Compliant System
 (ISA) 0x000000BD (189)	Microsoft ACPI-Compliant System
 (ISA) 0x000000BE (190)	Microsoft ACPI-Compliant System
 (ISA) 0x000000BF (191)	Microsoft ACPI-Compliant System
 (ISA) 0x000000C0 (192)	Microsoft ACPI-Compliant System
 (ISA) 0x000000C1 (193)	Microsoft ACPI-Compliant System
 (ISA) 0x000000C2 (194)	Microsoft ACPI-Compliant System
 (ISA) 0x000000C3 (195)	Microsoft ACPI-Compliant System
 (ISA) 0x000000C4 (196)	Microsoft ACPI-Compliant System
 (ISA) 0x000000C5 (197)	Microsoft ACPI-Compliant System
 (ISA) 0x000000C6 (198)	Microsoft ACPI-Compliant System
 (ISA) 0x000000C7 (199)	Microsoft ACPI-Compliant System
 (ISA) 0x000000C8 (200)	Microsoft ACPI-Compliant System
 (ISA) 0x000000C9 (201)	Microsoft ACPI-Compliant System
 (ISA) 0x000000CA (202)	Microsoft ACPI-Compliant System
 (ISA) 0x000000CB (203)	Microsoft ACPI-Compliant System
 (ISA) 0x000000CC (204)	Microsoft ACPI-Compliant System









































 (ISA) 0x000000CC (204)	Microsoft ACPI-Compliant System
 (ISA) 0x00000100 (256)	Microsoft ACPI-Compliant System
 (ISA) 0x00000101 (257)	Microsoft ACPI-Compliant System
 (ISA) 0x00000102 (258)	Microsoft ACPI-Compliant System
 (ISA) 0x00000103 (259)	Microsoft ACPI-Compliant System
 (ISA) 0x00000104 (260)	Microsoft ACPI-Compliant System
 (ISA) 0x00000105 (261)	Microsoft ACPI-Compliant System
 (ISA) 0x00000106 (262)	Microsoft ACPI-Compliant System
 (ISA) 0x00000107 (263)	Microsoft ACPI-Compliant System
 (ISA) 0x00000108 (264)	Microsoft ACPI-Compliant System
 (ISA) 0x00000109 (265)	Microsoft ACPI-Compliant System
 (ISA) 0x0000010A (266)	Microsoft ACPI-Compliant System
 (ISA) 0x0000010B (267)	Microsoft ACPI-Compliant System
 (ISA) 0x0000010C (268)	Microsoft ACPI-Compliant System
 (ISA) 0x0000010D (269)	Microsoft ACPI-Compliant System
 (ISA) 0x0000010E (270)	Microsoft ACPI-Compliant System
 (ISA) 0x0000010F (271)	Microsoft ACPI-Compliant System
 (ISA) 0x00000110 (272)	Microsoft ACPI-Compliant System
 (ISA) 0x00000111 (273)	Microsoft ACPI-Compliant System
 (ISA) 0x00000112 (274)	Microsoft ACPI-Compliant System
 (ISA) 0x00000113 (275)	Microsoft ACPI-Compliant System
 (ISA) 0x00000114 (276)	Microsoft ACPI-Compliant System
 (ISA) 0x00000115 (277)	Microsoft ACPI-Compliant System
 (ISA) 0x00000116 (278)	Microsoft ACPI-Compliant System
 (ISA) 0x00000117 (279)	Microsoft ACPI-Compliant System
 (ISA) 0x00000118 (280)	Microsoft ACPI-Compliant System
 (ISA) 0x00000119 (281)	Microsoft ACPI-Compliant System
 (ISA) 0x0000011A (282)	Microsoft ACPI-Compliant System
 (ISA) 0x0000011B (283)	Microsoft ACPI-Compliant System
 (ISA) 0x0000011C (284)	Microsoft ACPI-Compliant System
 (ISA) 0x0000011D (285)	Microsoft ACPI-Compliant System
 (ISA) 0x0000011E (286)	Microsoft ACPI-Compliant System
 (ISA) 0x0000011F (287)	Microsoft ACPI-Compliant System
 (ISA) 0x00000120 (288)	Microsoft ACPI-Compliant System
 (ISA) 0x00000121 (289)	Microsoft ACPI-Compliant System
 (ISA) 0x00000122 (290)	Microsoft ACPI-Compliant System
 (ISA) 0x00000123 (291)	Microsoft ACPI-Compliant System
 (ISA) 0x00000124 (292)	Microsoft ACPI-Compliant System
 (ISA) 0x00000125 (293)	Microsoft ACPI-Compliant System
 (ISA) 0x00000126 (294)	Microsoft ACPI-Compliant System

































 (ISA) 0x00000126 (294)	Microsoft ACPI-Compliant System
 (ISA) 0x00000127 (295)	Microsoft ACPI-Compliant System
 (ISA) 0x00000128 (296)	Microsoft ACPI-Compliant System
 (ISA) 0x00000129 (297)	Microsoft ACPI-Compliant System
 (ISA) 0x0000012A (298)	Microsoft ACPI-Compliant System
 (ISA) 0x0000012B (299)	Microsoft ACPI-Compliant System
 (ISA) 0x0000012C (300)	Microsoft ACPI-Compliant System
 (ISA) 0x0000012D (301)	Microsoft ACPI-Compliant System
 (ISA) 0x0000012E (302)	Microsoft ACPI-Compliant System
 (ISA) 0x0000012F (303)	Microsoft ACPI-Compliant System
 (ISA) 0x00000130 (304)	Microsoft ACPI-Compliant System
 (ISA) 0x00000131 (305)	Microsoft ACPI-Compliant System
 (ISA) 0x00000132 (306)	Microsoft ACPI-Compliant System
 (ISA) 0x00000133 (307)	Microsoft ACPI-Compliant System
 (ISA) 0x00000134 (308)	Microsoft ACPI-Compliant System
 (ISA) 0x00000135 (309)	Microsoft ACPI-Compliant System
 (ISA) 0x00000136 (310)	Microsoft ACPI-Compliant System
 (ISA) 0x00000137 (311)	Microsoft ACPI-Compliant System
 (ISA) 0x00000138 (312)	Microsoft ACPI-Compliant System
 (ISA) 0x00000139 (313)	Microsoft ACPI-Compliant System
 (ISA) 0x0000013A (314)	Microsoft ACPI-Compliant System
 (ISA) 0x0000013B (315)	Microsoft ACPI-Compliant System
 (ISA) 0x0000013C (316)	Microsoft ACPI-Compliant System
 (ISA) 0x0000013D (317)	Microsoft ACPI-Compliant System
 (ISA) 0x0000013E (318)	Microsoft ACPI-Compliant System
 (ISA) 0x0000013F (319)	Microsoft ACPI-Compliant System
 (ISA) 0x00000140 (320)	Microsoft ACPI-Compliant System
 (ISA) 0x00000141 (321)	Microsoft ACPI-Compliant System
 (ISA) 0x00000142 (322)	Microsoft ACPI-Compliant System
 (ISA) 0x00000143 (323)	Microsoft ACPI-Compliant System
 (ISA) 0x00000144 (324)	Microsoft ACPI-Compliant System
 (ISA) 0x00000145 (325)	Microsoft ACPI-Compliant System
 (ISA) 0x00000146 (326)	Microsoft ACPI-Compliant System
 (ISA) 0x00000147 (327)	Microsoft ACPI-Compliant System
 (ISA) 0x00000148 (328)	Microsoft ACPI-Compliant System
 (ISA) 0x00000149 (329)	Microsoft ACPI-Compliant System
 (ISA) 0x0000014A (330)	Microsoft ACPI-Compliant System
 (ISA) 0x0000014B (331)	Microsoft ACPI-Compliant System
 (ISA) 0x0000014C (332)	Microsoft ACPI-Compliant System
 (ISA) 0x0000014D (333)	Microsoft ACPI-Compliant System

 (ISA) 0x0000014D (333)	Microsoft ACPI-Compliant System
 (ISA) 0x0000014E (334)	Microsoft ACPI-Compliant System
 (ISA) 0x0000014F (335)	Microsoft ACPI-Compliant System
 (ISA) 0x00000150 (336)	Microsoft ACPI-Compliant System
 (ISA) 0x00000151 (337)	Microsoft ACPI-Compliant System
 (ISA) 0x00000152 (338)	Microsoft ACPI-Compliant System
 (ISA) 0x00000153 (339)	Microsoft ACPI-Compliant System
 (ISA) 0x00000154 (340)	Microsoft ACPI-Compliant System
 (ISA) 0x00000155 (341)	Microsoft ACPI-Compliant System
 (ISA) 0x00000156 (342)	Microsoft ACPI-Compliant System
 (ISA) 0x00000157 (343)	Microsoft ACPI-Compliant System
 (ISA) 0x00000158 (344)	Microsoft ACPI-Compliant System
 (ISA) 0x00000159 (345)	Microsoft ACPI-Compliant System
 (ISA) 0x0000015A (346)	Microsoft ACPI-Compliant System
 (ISA) 0x0000015B (347)	Microsoft ACPI-Compliant System
 (ISA) 0x0000015C (348)	Microsoft ACPI-Compliant System
 (ISA) 0x0000015D (349)	Microsoft ACPI-Compliant System
 (ISA) 0x0000015E (350)	Microsoft ACPI-Compliant System
 (ISA) 0x0000015F (351)	Microsoft ACPI-Compliant System
 (ISA) 0x00000160 (352)	Microsoft ACPI-Compliant System
 (ISA) 0x00000161 (353)	Microsoft ACPI-Compliant System
 (ISA) 0x00000162 (354)	Microsoft ACPI-Compliant System
 (ISA) 0x00000163 (355)	Microsoft ACPI-Compliant System
 (ISA) 0x00000164 (356)	Microsoft ACPI-Compliant System
 (ISA) 0x00000165 (357)	Microsoft ACPI-Compliant System
 (ISA) 0x00000166 (358)	Microsoft ACPI-Compliant System
 (ISA) 0x00000167 (359)	Microsoft ACPI-Compliant System
 (ISA) 0x00000168 (360)	Microsoft ACPI-Compliant System
 (ISA) 0x00000169 (361)	Microsoft ACPI-Compliant System
 (ISA) 0x0000016A (362)	Microsoft ACPI-Compliant System
 (ISA) 0x0000016B (363)	Microsoft ACPI-Compliant System
 (ISA) 0x0000016C (364)	Microsoft ACPI-Compliant System
 (ISA) 0x0000016D (365)	Microsoft ACPI-Compliant System
 (ISA) 0x0000016E (366)	Microsoft ACPI-Compliant System
 (ISA) 0x0000016F (367)	Microsoft ACPI-Compliant System
 (ISA) 0x00000170 (368)	Microsoft ACPI-Compliant System
 (ISA) 0x00000171 (369)	Microsoft ACPI-Compliant System
 (ISA) 0x00000172 (370)	Microsoft ACPI-Compliant System
 (ISA) 0x00000173 (371)	Microsoft ACPI-Compliant System
 (ISA) 0x00000174 (372)	Microsoft ACPI-Compliant System

 (ISA) 0x00000174 (372)	Microsoft ACPI-Compliant System
 (ISA) 0x00000175 (373)	Microsoft ACPI-Compliant System
 (ISA) 0x00000176 (374)	Microsoft ACPI-Compliant System
 (ISA) 0x00000177 (375)	Microsoft ACPI-Compliant System
 (ISA) 0x00000178 (376)	Microsoft ACPI-Compliant System
 (ISA) 0x00000179 (377)	Microsoft ACPI-Compliant System
 (ISA) 0x0000017A (378)	Microsoft ACPI-Compliant System
 (ISA) 0x0000017B (379)	Microsoft ACPI-Compliant System
 (ISA) 0x0000017C (380)	Microsoft ACPI-Compliant System
 (ISA) 0x0000017D (381)	Microsoft ACPI-Compliant System
 (ISA) 0x0000017E (382)	Microsoft ACPI-Compliant System
 (ISA) 0x0000017F (383)	Microsoft ACPI-Compliant System
 (ISA) 0x00000180 (384)	Microsoft ACPI-Compliant System
 (ISA) 0x00000181 (385)	Microsoft ACPI-Compliant System
 (ISA) 0x00000182 (386)	Microsoft ACPI-Compliant System
 (ISA) 0x00000183 (387)	Microsoft ACPI-Compliant System
 (ISA) 0x00000184 (388)	Microsoft ACPI-Compliant System
 (ISA) 0x00000185 (389)	Microsoft ACPI-Compliant System
 (ISA) 0x00000186 (390)	Microsoft ACPI-Compliant System
 (ISA) 0x00000187 (391)	Microsoft ACPI-Compliant System
 (ISA) 0x00000188 (392)	Microsoft ACPI-Compliant System
 (ISA) 0x00000189 (393)	Microsoft ACPI-Compliant System
 (ISA) 0x0000018A (394)	Microsoft ACPI-Compliant System
 (ISA) 0x0000018B (395)	Microsoft ACPI-Compliant System
 (ISA) 0x0000018C (396)	Microsoft ACPI-Compliant System
 (ISA) 0x0000018D (397)	Microsoft ACPI-Compliant System
 (ISA) 0x0000018E (398)	Microsoft ACPI-Compliant System
 (ISA) 0x0000018F (399)	Microsoft ACPI-Compliant System
 (ISA) 0x00000190 (400)	Microsoft ACPI-Compliant System
 (ISA) 0x00000191 (401)	Microsoft ACPI-Compliant System
 (ISA) 0x00000192 (402)	Microsoft ACPI-Compliant System
 (ISA) 0x00000193 (403)	Microsoft ACPI-Compliant System
 (ISA) 0x00000194 (404)	Microsoft ACPI-Compliant System
 (ISA) 0x00000195 (405)	Microsoft ACPI-Compliant System
 (ISA) 0x00000196 (406)	Microsoft ACPI-Compliant System
 (ISA) 0x00000197 (407)	Microsoft ACPI-Compliant System
 (ISA) 0x00000198 (408)	Microsoft ACPI-Compliant System
 (ISA) 0x00000199 (409)	Microsoft ACPI-Compliant System
 (ISA) 0x0000019A (410)	Microsoft ACPI-Compliant System
 (ISA) 0x0000019B (411)	Microsoft ACPI-Compliant System

 (ISA) 0x0000019B (411)	Microsoft ACPI-Compliant System
 (ISA) 0x0000019C (412)	Microsoft ACPI-Compliant System
 (ISA) 0x0000019D (413)	Microsoft ACPI-Compliant System
 (ISA) 0x0000019E (414)	Microsoft ACPI-Compliant System
 (ISA) 0x0000019F (415)	Microsoft ACPI-Compliant System
 (ISA) 0x000001A0 (416)	Microsoft ACPI-Compliant System
 (ISA) 0x000001A1 (417)	Microsoft ACPI-Compliant System
 (ISA) 0x000001A2 (418)	Microsoft ACPI-Compliant System
 (ISA) 0x000001A3 (419)	Microsoft ACPI-Compliant System
 (ISA) 0x000001A4 (420)	Microsoft ACPI-Compliant System
 (ISA) 0x000001A5 (421)	Microsoft ACPI-Compliant System
 (ISA) 0x000001A6 (422)	Microsoft ACPI-Compliant System
 (ISA) 0x000001A7 (423)	Microsoft ACPI-Compliant System
 (ISA) 0x000001A8 (424)	Microsoft ACPI-Compliant System
 (ISA) 0x000001A9 (425)	Microsoft ACPI-Compliant System
 (ISA) 0x000001AA (426)	Microsoft ACPI-Compliant System
 (ISA) 0x000001AB (427)	Microsoft ACPI-Compliant System
 (ISA) 0x000001AC (428)	Microsoft ACPI-Compliant System
 (ISA) 0x000001AD (429)	Microsoft ACPI-Compliant System
 (ISA) 0x000001AE (430)	Microsoft ACPI-Compliant System
 (ISA) 0x000001AF (431)	Microsoft ACPI-Compliant System
 (ISA) 0x000001B0 (432)	Microsoft ACPI-Compliant System
 (ISA) 0x000001B1 (433)	Microsoft ACPI-Compliant System
 (ISA) 0x000001B2 (434)	Microsoft ACPI-Compliant System
 (ISA) 0x000001B3 (435)	Microsoft ACPI-Compliant System
 (ISA) 0x000001B4 (436)	Microsoft ACPI-Compliant System
 (ISA) 0x000001B5 (437)	Microsoft ACPI-Compliant System
 (ISA) 0x000001B6 (438)	Microsoft ACPI-Compliant System
 (ISA) 0x000001B7 (439)	Microsoft ACPI-Compliant System
 (ISA) 0x000001B8 (440)	Microsoft ACPI-Compliant System
 (ISA) 0x000001B9 (441)	Microsoft ACPI-Compliant System
 (ISA) 0x000001BA (442)	Microsoft ACPI-Compliant System
 (ISA) 0x000001BB (443)	Microsoft ACPI-Compliant System
 (ISA) 0x000001BC (444)	Microsoft ACPI-Compliant System
 (ISA) 0x000001BD (445)	Microsoft ACPI-Compliant System
 (ISA) 0x000001BE (446)	Microsoft ACPI-Compliant System
 (ISA) 0x000001BF (447)	Microsoft ACPI-Compliant System
 (ISA) 0x000001C0 (448)	Microsoft ACPI-Compliant System
 (ISA) 0x000001C1 (449)	Microsoft ACPI-Compliant System
 (ISA) 0x000001C2 (450)	Microsoft ACPI-Compliant System

 (ISA) 0x000001C2 (450)	Microsoft ACPI-Compliant System
 (ISA) 0x000001C3 (451)	Microsoft ACPI-Compliant System
 (ISA) 0x000001C4 (452)	Microsoft ACPI-Compliant System
 (ISA) 0x000001C5 (453)	Microsoft ACPI-Compliant System
 (ISA) 0x000001C6 (454)	Microsoft ACPI-Compliant System
 (ISA) 0x000001C7 (455)	Microsoft ACPI-Compliant System
 (ISA) 0x000001C8 (456)	Microsoft ACPI-Compliant System
 (ISA) 0x000001C9 (457)	Microsoft ACPI-Compliant System
 (ISA) 0x000001CA (458)	Microsoft ACPI-Compliant System
 (ISA) 0x000001CB (459)	Microsoft ACPI-Compliant System
 (ISA) 0x000001CC (460)	Microsoft ACPI-Compliant System
 (ISA) 0x000001CD (461)	Microsoft ACPI-Compliant System
 (ISA) 0x000001CE (462)	Microsoft ACPI-Compliant System
 (ISA) 0x000001CF (463)	Microsoft ACPI-Compliant System
 (ISA) 0x000001D0 (464)	Microsoft ACPI-Compliant System
 (ISA) 0x000001D1 (465)	Microsoft ACPI-Compliant System
 (ISA) 0x000001D2 (466)	Microsoft ACPI-Compliant System
 (ISA) 0x000001D3 (467)	Microsoft ACPI-Compliant System
 (ISA) 0x000001D4 (468)	Microsoft ACPI-Compliant System
 (ISA) 0x000001D5 (469)	Microsoft ACPI-Compliant System
 (ISA) 0x000001D6 (470)	Microsoft ACPI-Compliant System
 (ISA) 0x000001D7 (471)	Microsoft ACPI-Compliant System
 (ISA) 0x000001D8 (472)	Microsoft ACPI-Compliant System
 (ISA) 0x000001D9 (473)	Microsoft ACPI-Compliant System
 (ISA) 0x000001DA (474)	Microsoft ACPI-Compliant System
 (ISA) 0x000001DB (475)	Microsoft ACPI-Compliant System
 (ISA) 0x000001DC (476)	Microsoft ACPI-Compliant System
 (ISA) 0x000001DD (477)	Microsoft ACPI-Compliant System
 (ISA) 0x000001DE (478)	Microsoft ACPI-Compliant System
 (ISA) 0x000001DF (479)	Microsoft ACPI-Compliant System
 (ISA) 0x000001E0 (480)	Microsoft ACPI-Compliant System
 (ISA) 0x000001E1 (481)	Microsoft ACPI-Compliant System
 (ISA) 0x000001E2 (482)	Microsoft ACPI-Compliant System
 (ISA) 0x000001E3 (483)	Microsoft ACPI-Compliant System
 (ISA) 0x000001E4 (484)	Microsoft ACPI-Compliant System
 (ISA) 0x000001E5 (485)	Microsoft ACPI-Compliant System
 (ISA) 0x000001E6 (486)	Microsoft ACPI-Compliant System
 (ISA) 0x000001E7 (487)	Microsoft ACPI-Compliant System
 (ISA) 0x000001E8 (488)	Microsoft ACPI-Compliant System
 (ISA) 0x000001E9 (489)	Microsoft ACPI-Compliant System

	(ISA) 0x000001E9 (489)	Microsoft ACPI-Compliant System
	(ISA) 0x000001EA (490)	Microsoft ACPI-Compliant System
	(ISA) 0x000001EB (491)	Microsoft ACPI-Compliant System
	(ISA) 0x000001EC (492)	Microsoft ACPI-Compliant System
	(ISA) 0x000001ED (493)	Microsoft ACPI-Compliant System
	(ISA) 0x000001EE (494)	Microsoft ACPI-Compliant System
	(ISA) 0x000001EF (495)	Microsoft ACPI-Compliant System
	(ISA) 0x000001F0 (496)	Microsoft ACPI-Compliant System
	(ISA) 0x000001F1 (497)	Microsoft ACPI-Compliant System
	(ISA) 0x000001F2 (498)	Microsoft ACPI-Compliant System
	(ISA) 0x000001F3 (499)	Microsoft ACPI-Compliant System
	(ISA) 0x000001F4 (500)	Microsoft ACPI-Compliant System
	(ISA) 0x000001F5 (501)	Microsoft ACPI-Compliant System
	(ISA) 0x000001F6 (502)	Microsoft ACPI-Compliant System
	(ISA) 0x000001F7 (503)	Microsoft ACPI-Compliant System
	(ISA) 0x000001F8 (504)	Microsoft ACPI-Compliant System
	(ISA) 0x000001F9 (505)	Microsoft ACPI-Compliant System
	(ISA) 0x000001FA (506)	Microsoft ACPI-Compliant System
	(ISA) 0x000001FB (507)	Microsoft ACPI-Compliant System
	(ISA) 0x000001FC (508)	Microsoft ACPI-Compliant System
	(ISA) 0x000001FD (509)	Microsoft ACPI-Compliant System
	(ISA) 0x000001FE (510)	Microsoft ACPI-Compliant System
	(ISA) 0x000001FF (511)	Microsoft ACPI-Compliant System
	(PCI) 0x00000010 (16)	High Definition Audio Controller
	(PCI) 0xFFFFFFFF6 (-10)	Intel(R) Ethernet Controller (3) I225-LM
	(PCI) 0xFFFFFFFF7 (-9)	Intel(R) Ethernet Controller (3) I225-LM
	(PCI) 0xFFFFFFFF8 (-8)	Intel(R) Ethernet Controller (3) I225-LM
	(PCI) 0xFFFFFFFF9 (-7)	Intel(R) Ethernet Controller (3) I225-LM
	(PCI) 0xFFFFFFFFFA (-6)	Intel(R) Ethernet Controller (3) I225-LM
	(PCI) 0xFFFFFFFFB (-5)	Intel(R) Iris(R) Xe Graphics
	(PCI) 0xFFFFFFFFC (-4)	Intel(R) USB 3.10 eXtensible Host Controller - 1.20 (Microsoft)
	(PCI) 0xFFFFFFFFD (-3)	Intel(R) USB 3.10 eXtensible Host Controller - 1.20 (Microsoft)
	(PCI) 0xFFFFFFFFE (-2)	Standard SATA AHCI Controller

Appendix C

Programming Digital I/O

C.1 Digital I/O Programming

The COM-TGUC6 utilizes an AAEON chipset as its Digital I/O controller.

Below are the procedures to complete its configuration, which you can use to develop a customized program to fit your application.

C.2 Digital I/O Register

Table 1: Embedded BRAM relative register table

	Default Value	Note
Index	0x284(Note1)	BRAM Index Register
Data	0x285(Note2)	BRAM Data Register
Logical Device Number	0xA2(Note3)	Watchdog Logical Device Number
IO Direction Function and Device Number	0x00(Note4)	DIO Input/ Output Function/Device Number
IO Vaule/Status Function and Device Number	0x01(Note5)	DIO Output Data Function/Device Number

Table 2: Digital I/O relative register table

	Register			
	Option Register	BitNum	Value	Note
GPI0 Pin Status	0x00(Note6)	0(Note7)	(Note15)	GPA2
GPI1 Pin Status	0x00(Note6)	1(Note8)	(Note16)	GPA3
GPI2 Pin Status	0x00(Note6)	2(Note9)	(Note17)	GPA4
GPI3 Pin Status	0x00(Note6)	3(Note10)	(Note18)	GPA5
GPO0 Pin Status	0x00(Note6)	4(Note11)	(Note19)	GPJ0
GPO1 Pin Status	0x00(Note6)	5(Note12)	(Note20)	GPJ1
GPO2 Pin Status	0x00(Note6)	6(Note13)	(Note21)	GPJ2
GPO3 Pin Status	0x00(Note6)	7(Note14)	(Note22)	GPJ3

C.3 Digital I/O Sample Program

```
*****
// Embedded BRAM relative definition (Please reference to Table 1)
#define byte EcBRAMIndex //This parameter is represented from Note1
#define byte EcBRAMData //This parameter is represented from Note2
#define byte BRAMLDNReg //This parameter is represented from Note3
#define byte BRAMFnData0Reg //This parameter is represented from Note4
#define byte BRAMFnData1Reg //This parameter is represented from Note5
#define void EcBRAMWriteByte(byte Offset, byte Value);
#define byte EcBRAMReadByte(byte Offset);
#define void IOWriteByte(byte Offset, byte Value);
#define byte IOReadByte(byte Offset);
// Digital Input Status relative definition (Please reference to Table 2)
#define byte DIO0ToDIO7Reg // This parameter is represented from Note6
#define byte DIO0Bit // This parameter is represented from Note7
#define byte DIO1Bit // This parameter is represented from Note8
#define byte DIO2Bit // This parameter is represented from Note9
#define byte DIO3Bit // This parameter is represented from Note10
#define byte DIO4Bit // This parameter is represented from Note11
#define byte DIO5Bit // This parameter is represented from Note12
#define byte DIO6Bit // This parameter is represented from Note13
#define byte DIO7Bit // This parameter is represented from Note14
#define byte DIO0Val // This parameter is represented from Note15
#define byte DIO1Val // This parameter is represented from Note16
#define byte DIO2Val // This parameter is represented from Note17
#define byte DIO3Val // This parameter is represented from Note18
#define byte DIO4Val // This parameter is represented from Note19
#define byte DIO5Val // This parameter is represented from Note20
#define byte DIO6Val // This parameter is represented from Note21
#define byte DIO7Val // This parameter is represented from Note22
*****
```

```
*****
VOID Main() {
    Boolean PinStatus;

    // Procedure : AaeonReadPinStatus
    // Input :
    //     Example, Read Digital I/O Pin 3 status
    // Output :
    //     InputStatus :
    //         0: Digital I/O Pin level is low
    //         1: Digital I/O Pin level is High
    PinStatus = AaeonReadPinStatus(DIO0ToDIO7Reg, DIO3Bit);

    // Procedure : AaeonSetOutputLevel
    // Input :
    //     Example, Set Digital I/O Pin 6 level
    AaeonSetOutputLevel(DIO0ToDIO7Reg, DIO6Bit, DIO6Val);
}
*****
```

```
*****
Boolean AaeonReadPinStatus(byte OptionReg, byte BitNum){
    Byte TempByte;

    TempByte = ECBRAMReadByte(BRAMFnData1Reg, OptionReg);
    If (TempByte & BitNum == 0)
        Return 0;
    Return 1;
}
VOID AaeonSetOutputLevel(byte OptionReg, byte BitNum, byte Value){
    Byte TempByte;

    TempByte = ECBRAMReadByte(BRAMFnData1Reg, OptionReg);
    TempByte |= (Value << BitNum);
    ECBRAMWriteByte(OptionReg, BitNum, Value);
}
*****
```

```
*****  
VOID ECBRAMWriteByte(byte OPReg, byte OPBit, byte Value){  
    IOWriteByte(EcBRAMIndex, 0x10);  
    IOWriteByte(EcBRAMData, BRAMLDNReg);  
    IOWriteByte(EcBRAMIndex, 0x11);  
    IOWriteByte(EcBRAMData, BRAMFnDataReg);  
  
    IOWriteByte(EcBRAMIndex, 0x13 + OPReg);  
    IOWriteByte(EcBRAMData, Value);  
  
    IOWriteByte(EcBRAMIndex, 0x12);  
    IOWriteByte(EcBRAMData, 0x30);        //Write start  
}  
  
Byte ECBRAMReadByte(byte FnDataReg, byte OPReg){  
    IOWriteByte(EcBRAMIndex, 0x10);  
    IOWriteByte(EcBRAMData, BRAMLDNReg);  
    IOWriteByte(EcBRAMIndex, 0x11);  
    IOWriteByte(EcBRAMData, FnDataReg);  
  
    IOWriteByte(EcBRAMIndex, 0x12);  
    IOWriteByte(EcBRAMData, 0x10);        //Read start  
  
    IOWriteByte(EcBRAMIndex, 0x13 + OPReg);  
    Return    IOReadByte(EcBRAMData, Value);  
}  
*****
```