

# COM-ICDB7

---

COM Express CPU Module

User's Manual 3<sup>rd</sup> Ed

## Copyright Notice

---

This document is copyrighted, 2023. All rights are reserved. The original manufacturer reserves the right to make improvements to the products described in this manual at any time without notice.

No part of this manual may be reproduced, copied, translated, or transmitted in any form or by any means without the prior written permission of the original manufacturer. Information provided in this manual is intended to be accurate and reliable. However, the original manufacturer assumes no responsibility for its use, or for any infringements upon the rights of third parties that may result from its use.

The material in this document is for product information only and is subject to change without notice. While reasonable efforts have been made in the preparation of this document to assure its accuracy, AAEON assumes no liabilities resulting from errors or omissions in this document, or from the use of the information contained herein.

AAEON reserves the right to make changes in the product design without notice to its users.

## Acknowledgements

---

All other products' name or trademarks are properties of their respective owners.

- Microsoft® Windows is a registered trademark of Microsoft Corp.
- Intel® and Xeon® are registered trademarks of Intel Corporation
- ITE is a trademark of Integrated Technology Express, Inc.
- IBM, PC/AT, PS/2, and VGA are trademarks of International Business Machines Corporation.

All other product names or trademarks are properties of their respective owners.

Omission from this list does not imply any claim of ownership by the publisher of this document.

## Packing List

---

Before setting up your product, please make sure the following items have been shipped:

Item	Quantity
● COM-ICDB7	1

If any of these items are missing or damaged, please contact your distributor or sales representative immediately.

## About this Document

---

This User's Manual contains all the essential information, such as detailed descriptions and explanations on the product's hardware and software features (if any), its specifications, dimensions, jumper/connector settings/definitions, and driver installation instructions (if any), to facilitate users in setting up their product.

Users may refer to the product page at [AAEON.com](http://AAEON.com) for the latest version of this document.

## Safety Precautions

---

Please read the following safety instructions carefully. It is advised that you keep this manual for future references

1. All cautions and warnings on the device should be noted.
2. Make sure the power source matches the power rating of the device.
3. Position the power cord so that people cannot step on it. Do not place anything over the power cord.
4. Always completely disconnect the power before working on the system's hardware.
5. No connections should be made when the system is powered as a sudden rush of power may damage sensitive electronic components.
6. If the device is not to be used for a long time, disconnect it from the power supply to avoid damage by transient over-voltage.
7. Always disconnect this device from any AC supply before cleaning.
8. While cleaning, use a damp cloth instead of liquid or spray detergents.
9. Make sure the device is installed near a power outlet and is easily accessible.
10. Keep this device away from humidity.
11. Place the device on a solid surface during installation to prevent falls
12. Do not cover the openings on the device to ensure optimal heat dissipation.
13. Watch out for high temperatures when the system is running.
14. Do not touch the heat sink or heat spreader when the system is running
15. Never pour any liquid into the openings. This could cause fire or electric shock.
16. As most electronic components are sensitive to static electrical charge, be sure to ground yourself to prevent static charge when installing the internal components. Use a grounding wrist strap and contain all electronic components in any static-shielded containers.

17. If any of the following situations arises, please the contact our service personnel:
  - i. Damaged power cord or plug
  - ii. Liquid intrusion to the device
  - iii. Exposure to moisture
  - iv. Device is not working as expected or in a manner as described in this manual
  - v. The device is dropped or damaged
  - vi. Any obvious signs of damage displayed on the device
18. **DO NOT LEAVE THIS DEVICE IN AN UNCONTROLLED ENVIRONMENT WITH TEMPERATURES BEYOND THE DEVICE'S PERMITTED STORAGE TEMPERATURES (SEE CHAPTER 1) TO PREVENT DAMAGE.**

### **Warning!**



This device complies with Part 15 FCC Rules. Operation is subject to the following two conditions: (1) this device may not cause harmful interference, and (2) this device must accept any interference received including interference that may cause undesired operation.

### **Caution:**

*There is a danger of explosion if the battery is incorrectly replaced. Replace only with the same or equivalent type recommended by the manufacturer. Dispose of used batteries according to the manufacturer's instructions and your local government's recycling or disposal directives.*

### **Attention:**

*Il y a un risque d'explosion si la batterie est remplacée de façon incorrecte. Ne la remplacer qu'avec le même modèle ou équivalent recommandé par le constructeur. Recycler les batteries usées en accord avec les instructions du fabricant et les directives gouvernementales de recyclage.*



## China RoHS Requirements (CN)

产品中有毒有害物质或元素名称及含量

AAEON Main Board/ Daughter Board/ Backplane

部件名称	有毒有害物质或元素					
	铅 (Pb)	汞 (Hg)	镉 (Cd)	六价铬 (Cr(VI))	多溴联苯 (PBB)	多溴二苯醚 (PBDE)
印刷电路板 及其电子组件	X	X	○	○	○	○
外部信号 连接器及线材	X	X	○	○	○	○
<p>O: 表示该有毒有害物质在该部件所有均质材料中的含量均在 SJ/T 11363-2006 标准规定的限量要求以下。</p> <p>X: 表示该有毒有害物质至少在该部件的某一均质材料中的含量超出 SJ/T 11363-2006 标准规定的限量要求。</p> <p>备注: 此产品所标示之环保使用期限, 系指在一般正常使用状况下。</p>						

## China RoHS Requirement (EN)

Poisonous or Hazardous Substances or Elements in Products

AAEON Main Board/ Daughter Board/ Backplane

Component	Poisonous or Hazardous Substances or Elements					
	Lead (Pb)	Mercury (Hg)	Cadmium (Cd)	Hexavalent Chromium (Cr(VI))	Polybrominated Biphenyls (PBB)	Polybrominated Diphenyl Ethers (PBDE)
PCB & Other Components	X	X	○	○	○	○
Wires & Connectors for External Connections	X	X	○	○	○	○
<p>O: The quantity of poisonous or hazardous substances or elements found in each of the component's parts is below the SJ/T 11363-2006-stipulated requirement.</p> <p>X: The quantity of poisonous or hazardous substances or elements found in at least one of the component's parts is beyond the SJ/T 11363-2006-stipulated requirement.</p> <p><b>Note:</b> The Environment Friendly Use Period as labeled on this product is applicable under normal usage only</p>						

# Table of Contents

---

<b>Chapter 1 - Product Specifications</b> .....	<b>1</b>
1.1 Specifications .....	2
<b>Chapter 2 – Hardware Information</b> .....	<b>4</b>
2.1 Dimensions .....	5
2.2 Switches and Connectors .....	8
2.3 List of Connectors.....	10
2.3.1 AT/ATX Switch (SW1) .....	10
2.3.2 Battery (CN3).....	10
2.3.3 EC Programming Header (CN4).....	11
2.3.4 BIOS Programming Header (CN5).....	11
2.3.5 ROW A/B Connector (CN8).....	12
2.3.6 ROW C/D Connector (CN9) .....	17
2.3.7 LPC (CN10) .....	22
2.3.8 LAN GPIO (I210-IT) (CN11) .....	22
2.4 Function Block Diagram.....	23
2.5 Hardware Assembly .....	24
2.5.1 CPU Cooler Assembly.....	24
2.5.2 Heat Spreader Assembly.....	26
<b>Chapter 3 - AMI BIOS Setup</b> .....	<b>28</b>
3.1 System Test and Initialization .....	29
3.2 AMI BIOS Setup .....	30
3.3 Setup Submenu: Main.....	31
3.4 Setup Submenu: Advanced.....	32
3.4.1 Trusted Computing.....	33
3.4.2 NVMe Configuration.....	35
3.4.3 Hardware Monitor .....	36

3.4.4	SIO Configuration.....	37
3.4.5	Serial Port Configuration.....	38
3.4.6	Serial Port Console Redirection .....	39
3.4.7	AAEON BIOS Robot.....	40
3.4.8	Power Management.....	42
3.4.9	Digital IO Port Configuration .....	43
3.5	Setup Submenu: Platform Configuration .....	44
3.5.1	PCH-IO Configuration .....	45
3.5.2	PCI Express Configuration.....	46
3.5.3	SATA Configuration .....	47
3.5.4	Server ME Configuration.....	48
3.6	Setup Submenu: Socket Configuration.....	49
3.6.1	Processor Configuration.....	50
3.6.2	Memory Configuration.....	51
3.6.3	Memory Topology .....	52
3.6.4	IIO Configuration.....	53
3.6.5	Socket0 Configuration .....	54
3.7	Setup Submenu: Security.....	55
3.7.1	Secure Boot.....	56
3.7.2	Key Management.....	57
3.8	Setup Submenu: Boot .....	59
3.8.1	BBS Priorities.....	60
3.9	Setup Submenu: Save & Exit.....	61
<b>Chapter 4 – Drivers Installation.....</b>		<b>62</b>
4.1	Drivers Download and Installation.....	63

Appendix A - I/O Information..... 64

    A.1 I/O Address Map ..... 65

    A.2 Memory Address Map ..... 67

    A.3 IRQ Mapping Chart..... 68

# Chapter 1

---

Product Specifications

## 1.1 Specifications

### System

Form Factor	PICMG COM Express R3.0, Type 7
CPU	Intel® Xeon® D1700 LCC Processors
CPU Frequency	Up to 2.0 GHz, D-1746TER
Chipset	SoC
Memory Type	DDR4 SODIMM Socket x 2
Max. Memory Capacity	Up to 64GB (ECC Support by SKU)
BIOS	UEFI
Wake on LAN	Yes
Watchdog Timer	255 Levels
Power Requirement	+12V and +5VSB for ATX, +12V for AT
Power Supply Type	AT (Default)/ATX
Power Consumption (Typical)	7.75A @12V, D-1746TER
Dimension (L x W)	4.92" x 3.75" (125mm x 95mm)
Operating Temperature	32°F ~ 140°F (0°C ~ 60°C)
Storage Temperature	-40°F ~ 185°F (-40°C ~ 85°C)
Operating Humidity	0% ~ 90% relative humidity, non-condensing
Certification	CE / FCC Class A (Pre-test with Class B standard)

### Display

Graphic Controller	N/A
Video Output	N/A

## I/O

Ethernet	1GbE: Intel® I210-IT 10GbE: 10GbE x 4 (Base-KR to Carrier Board)
Audio	—
USB Port	USB 2.0 x 4, USB 3.2 Gen 1 x 1
Serial Port	2-Wire UART (Tx/Rx) x 2
HDD Interface	SATA III x 2
Expansion Slot	PCIe [x16] x 1, PCIe [x4] X 4 I2C x 1 (Windows® 10 Ready) LPC x 1 SMBus x 1
GPIO	8-bit
Onboard Storage	—
TPM	TPM 2.0



# Chapter 2

---

Hardware Information

## 2.1 Dimensions

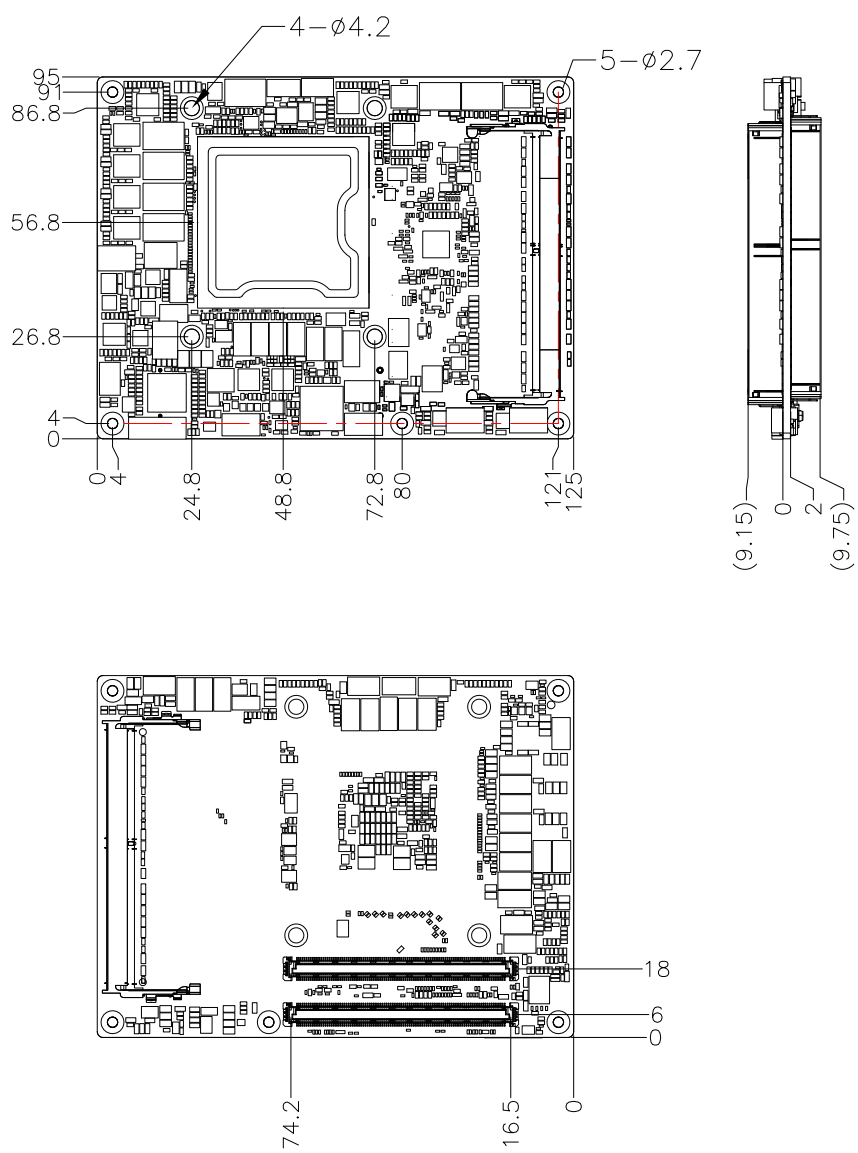

With DDR:

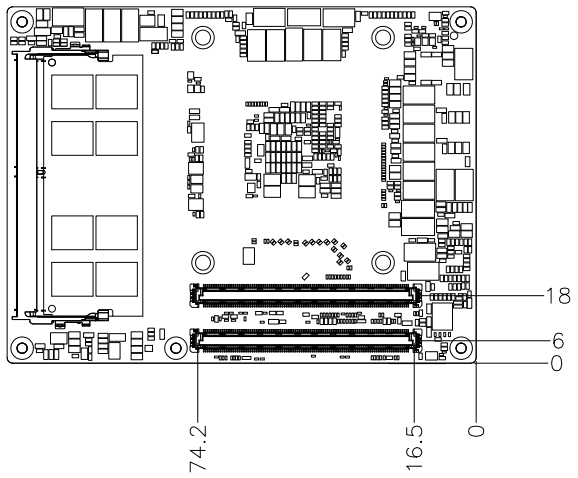
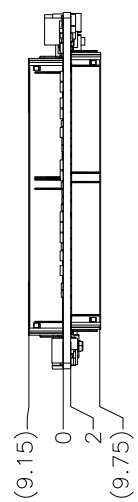
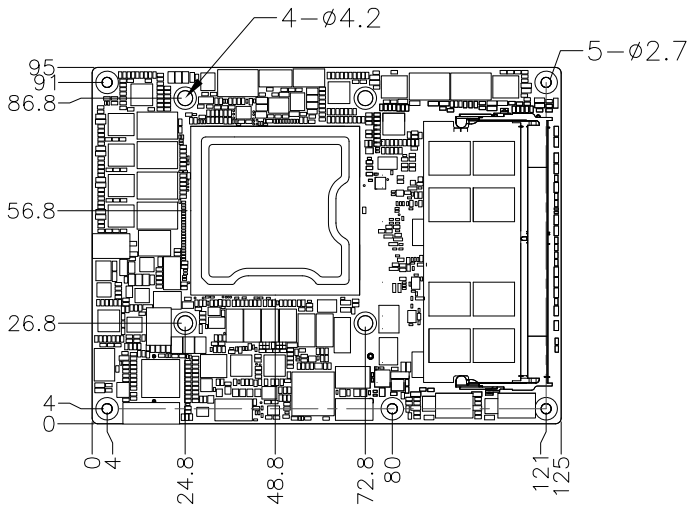

With Heatspreader and Active Cooler:

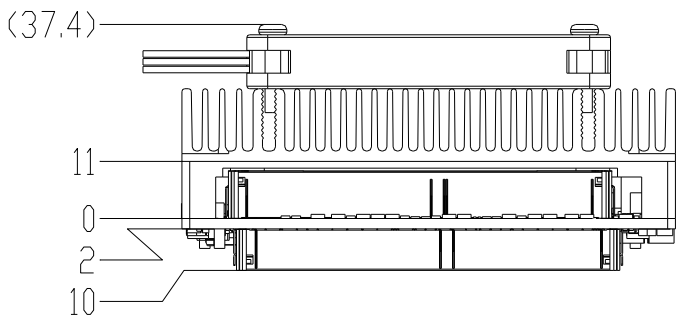

With Active Cooler:

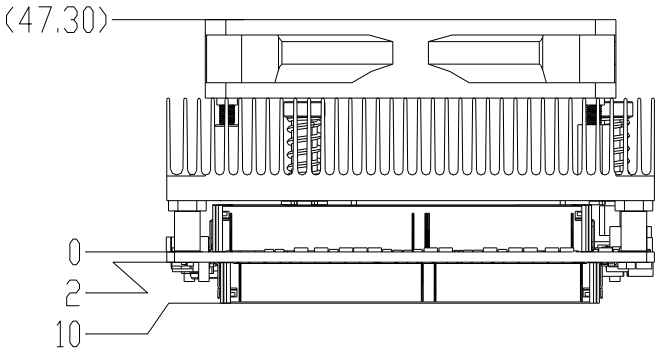

## 2.2 Switches and Connectors

### Top Side

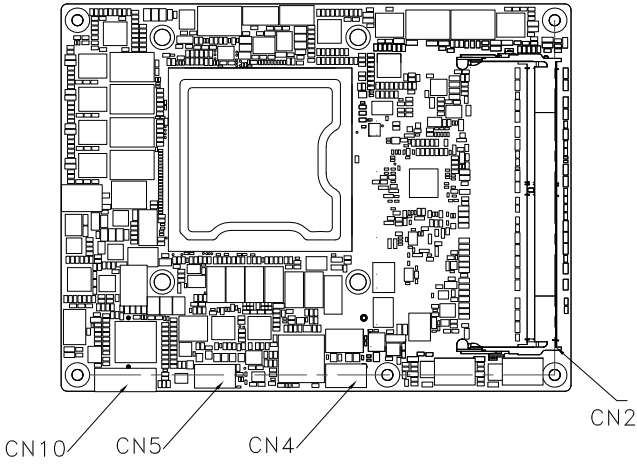

### Bottom Side

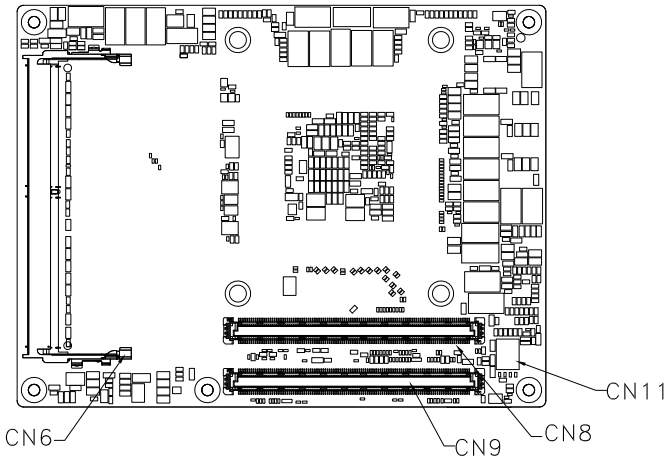

### Top Side with DDR

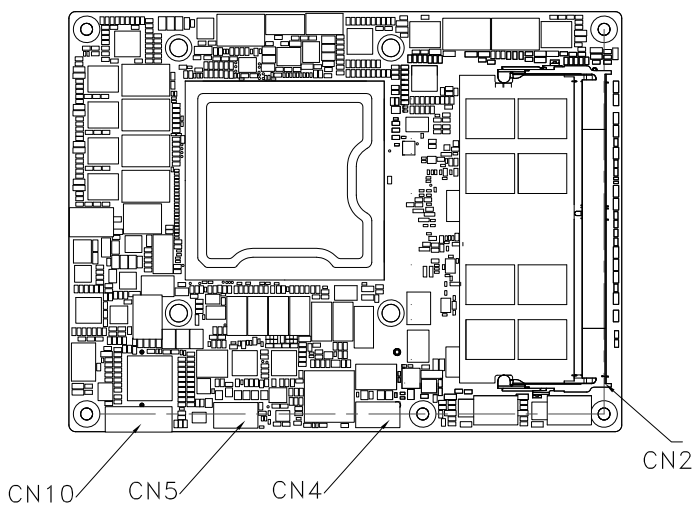

### Bottom Side with DDR

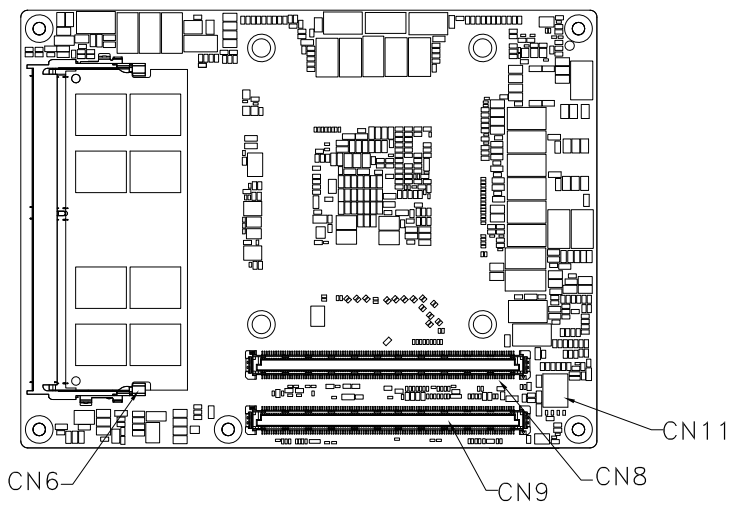

## 2.3 List of Connectors

---

Please refer to the table below for all of the board's switches and connectors that you can configure for your application

Label	Function
SW1	AT/ATX Switch
CN3	Battery
CN4	EC Programming Header
CN5	BIOS Programming Header
CN8	ROW A/B
CN9	ROW C/D
CN10	LPC
CN11	LAN GPIO (I210-IT)

### 2.3.1 AT/ATX Switch (SW1)

---

Pin	ON	OFF
1	AT Mode (Default)	ATX Mode
2	RTC Reset	RTC Normal (Default)

### 2.3.2 Battery (CN3)

---

Pin	Signal
1	+3.3V
2	GND

### 2.3.3 EC Programming Header (CN4)

---

Pin	Signal
1	SPI_MISO
2	GND
3	SPI_CLK
4	+3.3VSB
5	SPI_MOSI
6	SPI_CS
7	NC

### 2.3.4 BIOS Programming Header (CN5)

---

Pin	Signal
1	SPI_MISO
2	GND
3	SPI_CLK
4	+3.3VSB
5	SPI_MOSI
6	SPI_CS
7	NC



### 2.3.5 ROW A/B Connector (CN8)

Row A		Row B	
Pin	Signal	Pin	Signal
A1	GND(FIXED)	B1	GND(FIXED)
A2	GBE0_MDI3-	B2	GBE0_ACT#
A3	GBE0_MDI3+	B3	LPC_FRAME#
A4	GBE0_LINK100#	B4	LPC_AD0
A5	GBE0_LINK1000#	B5	LPC_AD1
A6	GBE0_MDI2-	B6	LPC_AD2
A7	GBE0_MDI2+	B7	LPC_AD3
A8	GBE0_LINK#	B8	LPC_DRQ0#
A9	GBE0_MDI1-	B9	LPC_DRQ1#
A10	GBE0_MDI1+	B10	LPC_CLK
A11	GND(FIXED)	B11	GND(FIXED)
A12	GBE0_MDI0-	B12	PWRBTN#
A13	GBE0_MDI0+	B13	SMB_CK
A14	GBE0_CTREF	B14	SMB_DAT
A15	SUS_S3#	B15	SMB_ALERT#
A16	SATA0_TX+	B16	SATA1_TX+
A17	SATA0_TX-	B17	SATA1_TX-
A18	SUS_S4#	B18	SUS_STAT#
A19	SATA0_RX+	B19	SATA1_RX+
A20	SATA0_RX-	B20	SATA1_RX-
A21	GND(FIXED)	B21	GND(FIXED)
A22	PCIE_TX15+	B22	PCIE_RX15+
A23	PCIE_TX15-	B23	PCIE_RX15-

Row A		Row B	
Pin	Signal	Pin	Signal
A24	SUS_S5#	B24	PWR_OK
A25	PCIE_TX14+	B25	PCIE_RX14+
A26	PCIE_TX14-	B26	PCIE_RX14-
A27	BATLOW#	B27	WDT
A28	(S)ATA_ACT#	B28	RSVD
A29	RSVD	B29	RSVD
A30	RSVD	B30	RSVD
A31	GND(FIXED)	B31	GND(FIXED)
A32	RSVD	B32	SPKR
A33	RSVD	B33	I2C_CK
A34	BIOS_DIS0#	B34	I2C_DAT
A35	THRMTRIP#	B35	THRM#
A36	PCIE_TX13+	B36	PCIE_RX13+
A37	PCIE_TX13-	B37	PCIE_RX13-
A38	GND	B38	GND
A39	PCIE_TX12+	B39	PCIE_RX12+
A40	PCIE_TX12-	B40	PCIE_RX12-
A41	GND(FIXED)	B41	GND(FIXED)
A42	USB2-	B42	USB3-
A43	USB2+	B43	USB3+
A44	USB_2_3_OC#	B44	USB_0_1_OC#
A45	USB0-	B45	USB1-
A46	USB0+	B46	USB1+
A47	VCC_RTC	B47	ESPI_EN
A48	RSVD	B48	RSVD

Row A		Row B	
Pin	Signal	Pin	Signal
A49	RSVD	B49	SYS_RESET#
A50	LPC_SERIRQ	B50	CB_RESET#
A51	GND(FIXED)	B51	GND(FIXED)
A52	PCIE_TX5+	B52	PCIE_RX5+
A53	PCIE_TX5-	B53	PCIE_RX5-
A54	GPIO	B54	GPO1
A55	PCIE_TX4+	B55	PCIE_RX4+
A56	PCIE_TX4-	B56	PCIE_RX4-
A57	GND	B57	GPO2
A58	PCIE_TX3+	B58	PCIE_RX3+
A59	PCIE_TX3-	B59	PCIE_RX3-
A60	GND(FIXED)	B60	GND(FIXED)
A61	PCIE_TX2+	B61	PCIE_RX2+
A62	PCIE_TX2-	B62	PCIE_RX2-
A63	GPIO	B63	GPO3
A64	PCIE_TX1+	B64	PCIE_RX1+
A65	PCIE_TX1-	B65	PCIE_RX1-
A66	GND	B66	WAKE0#
A67	GPIO	B67	WAKE1#
A68	PCIE_TX0+	B68	PCIE_RX0+
A69	PCIE_TX0-	B69	PCIE_RX0-
A70	GND(FIXED)	B70	GND(FIXED)
A71	PCIE_TX8+	B71	PCIE_RX8+
A72	PCIE_TX8-	B72	PCIE_RX8-
A73	GND	B73	GND

Row A		Row B	
Pin	Signal	Pin	Signal
A74	PCIE_TX9+	B74	PCIE_RX9+
A75	PCIE_TX9-	B75	PCIE_RX9-
A76	GND	B76	GND
A77	PCIE_TX10+	B77	PCIE_RX10+
A78	PCIE_TX10-	B78	PCIE_RX10-
A79	GND	B79	GND
A80	GND(FIXED)	B80	GND(FIXED)
A81	PCIE_TX11+	B81	PCIE_RX11+
A82	PCIE_TX11-	B82	PCIE_RX11-
A83	GND	B83	GND
A84	NCSI_TX_EN	B84	VCC_5V_SBY
A85	GPI3	B85	VCC_5V_SBY
A86	RSVD	B86	VCC_5V_SBY
A87	RSVD	B87	VCC_5V_SBY
A88	PCIE_CK_REF+	B88	BIOS_DIS1#
A89	PCIE_CK_REF-	B89	NCSI_RX_ER
A90	GND(FIXED)	B90	GND(FIXED)
A91	SPI_POWER	B91	NCSI_CLK_IN
A92	SPI_MISO	B92	NCSI_RXD1
A93	GPO0	B93	NCSI_RXD0
A94	SPI_CLK	B94	NCSI_CRS_DV
A95	SPI_MOSI	B95	NCSI_TXD1
A96	TPM_PP	B96	NCSI_TXD0
A97	TYPE10#	B97	SPI_CS#
A98	SER0_TX	B98	NCSI_ARB_IN

Row A		Row B	
Pin	Signal	Pin	Signal
A99	SER0_RX	B99	NCSI_ARB_OUT
A100	GND(FIXED)	B100	GND(FIXED)
A101	SER1_TX	B101	FAN_PWMOUT
A102	SER1_RX	B102	FAN_TACHIN
A103	LID#	B103	SLEEP#
A104	VCC_12V	B104	VCC_12V
A105	VCC_12V	B105	VCC_12V
A106	VCC_12V	B106	VCC_12V
A107	VCC_12V	B107	VCC_12V
A108	VCC_12V	B108	VCC_12V
A109	VCC_12V	B109	VCC_12V
A110	GND(FIXED)	B110	GND(FIXED)

### 2.3.6 ROW C/D Connector (CN9)

Row C		Row D	
Pin	Signal	Pin	Signal
C1	GND(FIXED)	D1	GND(FIXED)
C2	GND	D2	GND
C3	USB_SSRX0-	D3	USB_SSTX0-
C4	USB_SSRX0+	D4	USB_SSTX0+
C5	GND	D5	GND
C6	USB_SSRX1-	D6	USB_SSTX1-
C7	USB_SSRX1+	D7	USB_SSTX1+
C8	GND	D8	GND
C9	USB_SSRX2-	D9	USB_SSTX2-
C10	USB_SSRX2+	D10	USB_SSTX2+
C11	GND(FIXED)	D11	GND(FIXED)
C12	USB_SSRX3-	D12	USB_SSTX3-
C13	USB_SSRX3+	D13	USB_SSTX3+
C14	GND	D14	GND
C15	10G_PHY_MDC_SCL3	D15	10G_PHY_MDIO_SDA3
C16	10G_PHY_MDC_SCL2	D16	10G_PHY_MDIO_SDA2
C17	10G_SDP2	D17	10G_SDP3
C18	GND	D18	GND
C19	PCIE_RX6+	D19	PCIE_TX6+
C20	PCIE_RX6-	D20	PCIE_TX6-
C21	GND(FIXED)	D21	GND(FIXED)
C22	PCIE_RX7+	D22	PCIE_TX7+
C23	PCIE_RX7-	D23	PCIE_TX7-

Row C		Row D	
Pin	Signal	Pin	Signal
C24	10G_INT2	D24	10G_INT3
C25	GND	D25	GND
C26	10G_KR_RX3+	D26	10G_KR_TX3+
C27	10G_KR_RX3-	D27	10G_KR_TX3-
C28	GND	D28	GND
C29	10G_KR_RX2+	D29	10G_KR_TX2+
C30	10G_KR_RX2-	D30	10G_KR_TX2-
C31	GND(FIXED)	D31	GND(FIXED)
C32	10G_SFP_SDA3	D32	10G_SFP_SCL3
C33	10G_SFP_SDA2	D33	10G_SFP_SCL2
C34	10G_PHY_RST_23	D34	10G_PHY_SEL_23
C35	10G_PHY_RST_01	D35	10G_PHY_SEL_01
C36	10G_LED_SDA	D36	RSVD
C37	10G_LED_SCL	D37	RSVD
C38	10G_SFP_SDA1	D38	10G_SFP_SCL1
C39	10G_SFP_SDA0	D39	10G_SFP_SCL0
C40	10G_SDP0	D40	10G_SDP1
C41	GND(FIXED)	D41	GND(FIXED)
C42	10G_KR_RX1+	D42	10G_KR_TX1+
C43	10G_KR_RX1-	D43	10G_KR_TX1-
C44	GND	D44	GND
C45	10G_PHY_MDC_SCL1	D45	10G_PHY_MDIO_SDA1
C46	10G_PHY_MDC_SCL0	D46	10G_PHY_MDIO_SDA0
C47	10G_INT0	D47	10G_INT1
C48	GND	D48	GND

Row C		Row D	
Pin	Signal	Pin	Signal
C49	10G_KR_RX0+	D49	10G_KR_TX0+
C50	10G_KR_RX0-	D50	10G_KR_TX0-
C51	GND(FIXED)	D51	GND(FIXED)
C52	PCIE_RX16+	D52	PCIE_TX16+
C53	PCIE_RX16-	D53	PCIE_TX16-
C54	TYPE0#	D54	RSVD
C55	PCIE_RX17+	D55	PCIE_TX17+
C56	PCIE_RX17-	D56	PCIE_TX17-
C57	TYPE1#	D57	TYPE2#
C58	PCIE_RX18+	D58	PCIE_TX18+
C59	PCIE_RX18-	D59	PCIE_TX18-
C60	GND(FIXED)	D60	GND(FIXED)
C61	PCIE_RX19+	D61	PCIE_TX19+
C62	PCIE_RX19-	D62	PCIE_TX19-
C63	RSVD	D63	RSVD
C64	RSVD	D64	RSVD
C65	PCIE_RX20+	D65	PCIE_TX20+
C66	PCIE_RX20-	D66	PCIE_TX20-
C67	RSVD	D67	GND
C68	PCIE_RX21+	D68	PCIE_TX21+
C69	PCIE_RX21-	D69	PCIE_TX21-
C70	GND(FIXED)	D70	GND(FIXED)
C71	PCIE_RX22+	D71	PCIE_TX22+
C72	PCIE_RX22-	D72	PCIE_TX22-
C73	GND	D73	GND



Row C		Row D	
Pin	Signal	Pin	Signal
C74	PCIE_RX23+	D74	PCIE_TX23+
C75	PCIE_RX23-	D75	PCIE_TX23-
C76	GND	D76	GND
C77	RSVD	D77	RSVD
C78	PCIE_RX24+	D78	PCIE_TX24+
C79	PCIE_RX24-	D79	PCIE_TX24-
C80	GND(FIXED)	D80	GND(FIXED)
C81	PCIE_RX25+	D81	PCIE_TX25+
C82	PCIE_RX25-	D82	PCIE_TX25-
C83	RSVD	D83	RSVD
C84	GND	D84	GND
C85	PCIE_RX26+	D85	PCIE_TX26+
C86	PCIE_RX26-	D86	PCIE_TX26-
C87	GND	D87	GND
C88	PCIE_RX27+	D88	PCIE_TX27+
C89	PCIE_RX27-	D89	PCIE_TX27-
C90	GND(FIXED)	D90	GND(FIXED)
C91	PCIE_RX28+	D91	PCIE_TX28+
C92	PCIE_RX28-	D92	PCIE_TX28-
C93	GND	D93	GND
C94	PCIE_RX29+	D94	PCIE_TX29+
C95	PCIE_RX29-	D95	PCIE_TX29-
C96	GND	D96	GND
C97	RSVD	D97	RSVD
C98	PCIE_RX30+	D98	PCIE_TX30+

Row C		Row D	
Pin	Signal	Pin	Signal
C99	PCIE_RX30-	D99	PCIE_TX30-
C100	GND(FIXED)	D100	GND(FIXED)
C101	PCIE_RX31+	D101	PCIE_TX31+
C102	PCIE_RX31-	D102	PCIE_TX31-
C103	GND	D103	GND
C104	VCC_12V	D104	VCC_12V
C105	VCC_12V	D105	VCC_12V
C106	VCC_12V	D106	VCC_12V
C107	VCC_12V	D107	VCC_12V
C108	VCC_12V	D108	VCC_12V
C109	VCC_12V	D109	VCC_12V
C110	GND(FIXED)	D110	GND(FIXED)

### 2.3.7 LPC (CN10)

---

Pin	Signal
1	LAD0
2	LAD1
3	LAD2
4	LAD3
5	+3.3V
6	LFRAME#
7	LRESET#
8	GND
9	LCLK
10	NC
11	NC
12	SERIRQ

### 2.3.8 LAN GPIO (I210-IT) (CN11)

---

Pin	Signal
1	SDP1
2	SDP2
3	SDP3
4	SDP4
5	GND
6	GND

## 2.4 Function Block Diagram

### COM-ICDB7 Block Diagram

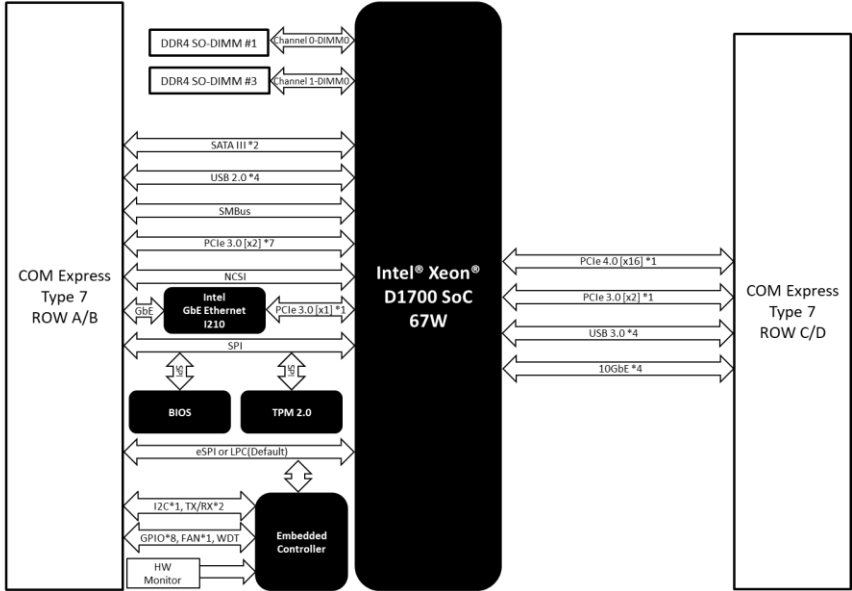

## 2.5 Hardware Assembly

### 2.5.1 CPU Cooler Assembly

Step 1:

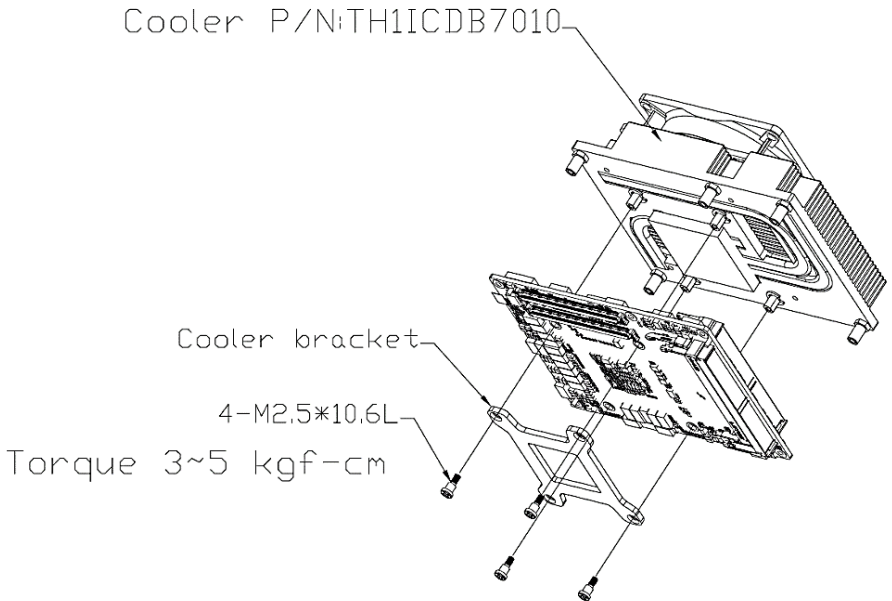

**Note:** Slightly tighten all four screws in diagonal order. Then, repeat with torque 3-5 kgf-cm with proper tools.

**Note:** According to the CPU spec, the CPU case should be kept at or below 85°C for your thermal design consideration.

Step 2:

5-M2.5\*20L  
Torque 3~5 kgf-cm

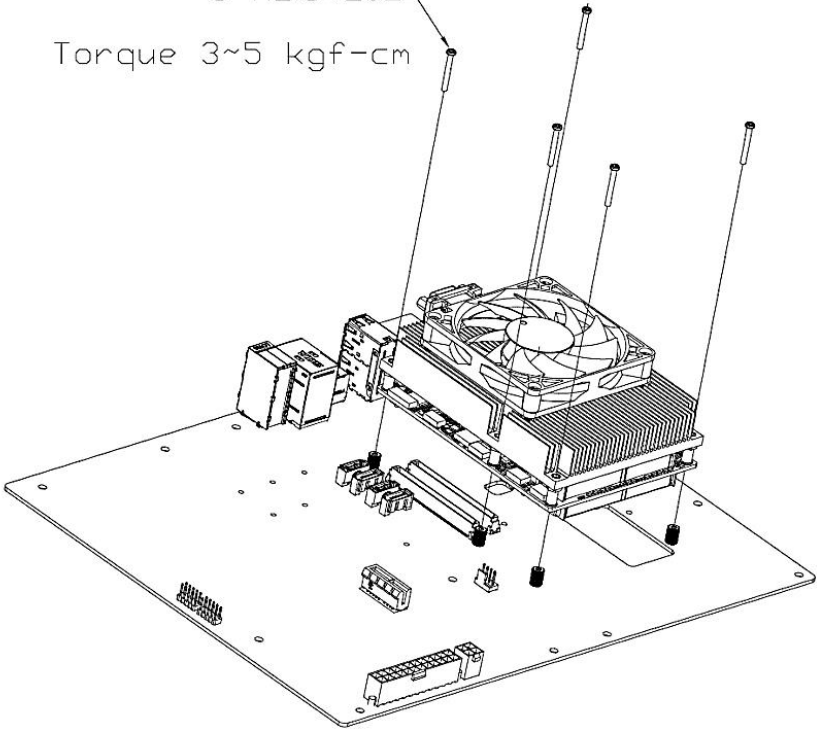

## 2.5.2 Heat Spreader Assembly

Step 1:

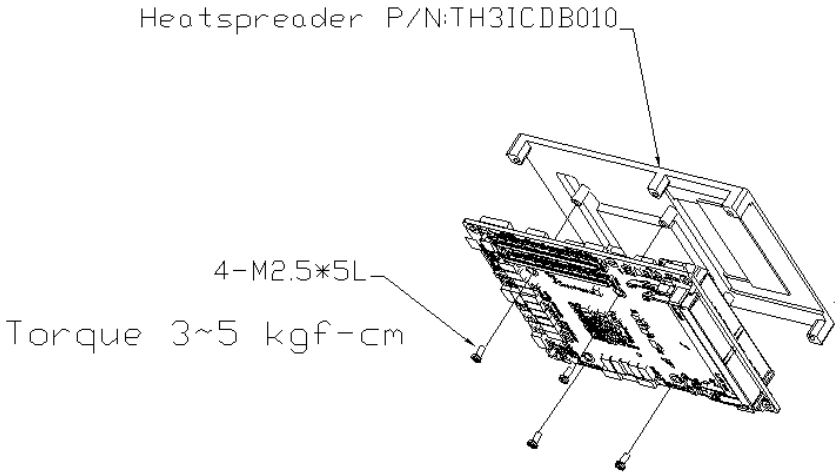

**Note:** Slightly tighten all four screws in diagonal order. Then, repeat with torque 3-5 kgf-cm with proper tools

**Note:** According to the CPU spec, the CPU Tcase should be kept at or below 85°C for your thermal design consideration.

Step 2:

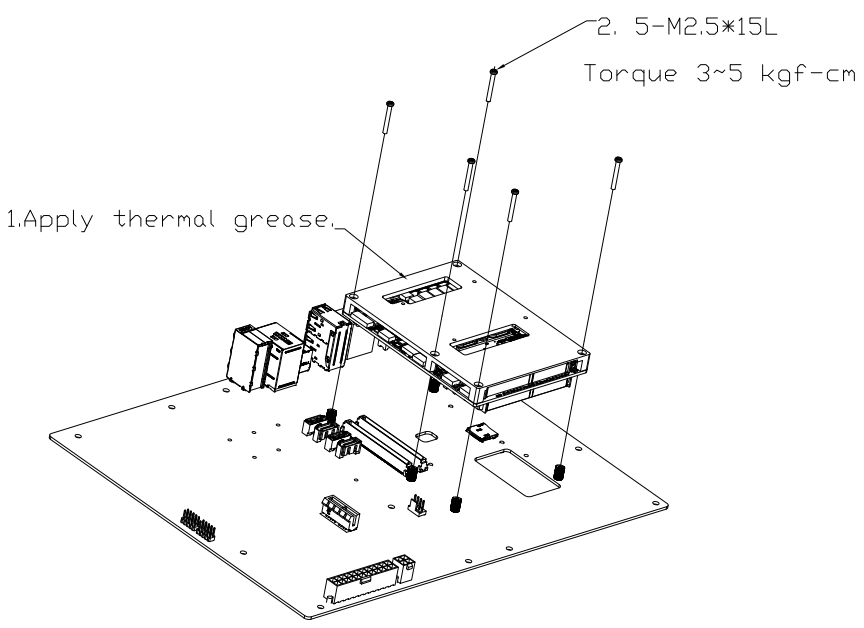



# Chapter 3

---

AMI BIOS Setup

## 3.1 System Test and Initialization

---

These routines test and initialize board hardware. If the routines encounter an error during the tests, you will either hear a few short beeps or see an error message on the screen. There are two kinds of errors: fatal and non-fatal. The system can usually continue the boot up sequence with non-fatal errors.

### System configuration verification

These routines check the current system configuration stored in the CMOS memory and BIOS NVRAM. If system configuration is not found or system configuration data error is detected, system will load optimized default and re-boot with this default system configuration automatically.

There are four situations in which you will need to setup system configuration:

1. You are starting your system for the first time.
2. You have changed the hardware attached to your system.
3. The system configuration is reset by Clear-CMOS jumper.
4. The CMOS memory has lost power and the configuration information has been erased.

The COM-ICDB7 CMOS memory has an integral lithium battery backup for data retention. However, you will need to replace the complete unit when it finally runs down.

## 3.2 AMI BIOS Setup

---

AMI BIOS ROM has a built-in Setup program that allows users to modify the basic system configuration. This type of information is stored in battery-backed CMOS RAM and BIOS NVRAM so that it retains the Setup information when the power is turned off.

### Entering Setup

Power on the computer and press <Del> or <ESC> immediately. This will allow you to enter Setup.

### Main

Set the date, use tab to switch between date elements.

### Advanced

Enable/disable boot option for legacy network devices.

### Platform Configuration

Chipset and ME Parameters.

### Socket Configuration

Processor and Memory Parameters.

### Security

Set setup administrator password

### Boot

Enables/disables quiet boot option.

### Save & Exit

Exit system setup after saving the changes.

### 3.3 Setup Submenu: Main

**Aptio Setup - AMI**

Main Advanced Platform Configuration Socket Configuration Security Boot Save & Exit

BIOS Information CDM-ICDB7 R1.2 (CID7AM12) (06/17/2022)	Set the Date. Use Tab to switch between Date elements. Default Ranges: Year: 1998-9999 Months: 1-12 Days: Dependent on month Range of Years may vary.
BIOS Vendor Compliance	American Megatrends UEFI 2.8; PI 1.7
EC Information (CIDB7E10) (6/14/2022)	
System Date	[Tue 07/19/2022]
System Time	[01:54:34]
Access Level	Administrator

++: Select Screen  
T1: Select Item  
Enter: Select  
+/-: Change Opt.  
F1: General Help  
F2: Previous Values  
F3: Optimized Defaults  
F4: Save & Exit  
ESC: Exit

Version 2.22.1285 Copyright (C) 2022 AMI

### 3.4 Setup Submenu: Advanced

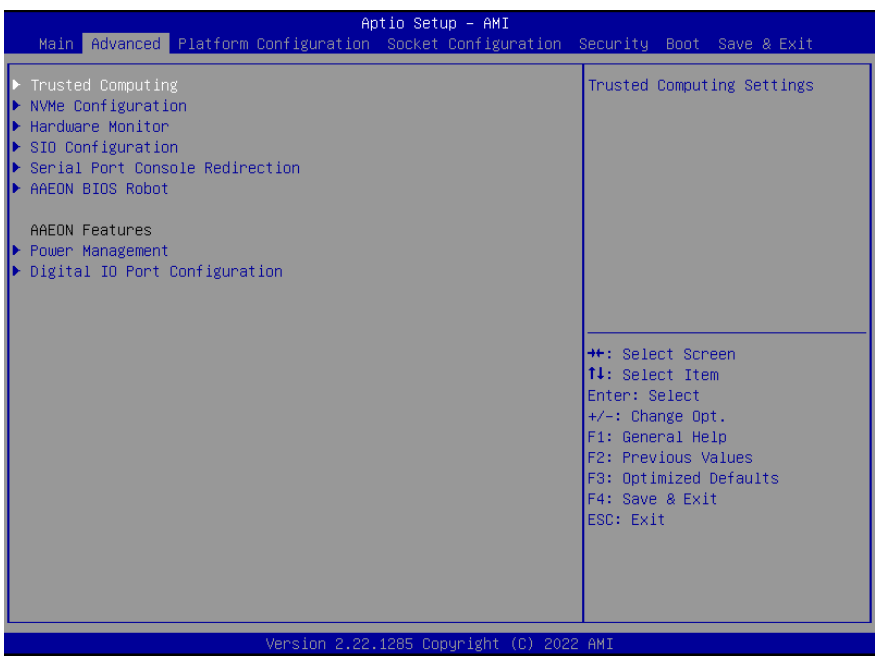

### 3.4.1 Trusted Computing

Aptio Setup - AMI

Advanced		
TPM 2.0 Device Found Firmware Version: 7.2 Vendor: NTC  Security Device Support [Enable] Active PCR banks SHA256 Available PCR banks SHA-1,SHA256,SHA384  SHA-1 PCR Bank [Disabled] SHA256 PCR Bank [Enabled] SHA384 PCR Bank [Disabled]  Pending operation [None] Platform Hierarchy [Enabled] Storage Hierarchy [Enabled] Endorsement Hierarchy [Enabled] TPM 2.0 UEFI Spec Version [TCG_2] Physical Presence Spec Version [1.3] TPM 2.0 InterfaceType [TIS] Device Select [Auto]	Enables or Disables BIOS support for security device. O.S. will not show Security Device. TCG EFI protocol and INT1A interface will not be available.	+-: Select Screen T1: Select Item Enter: Select +/-: Change Opt. F1: General Help F2: Previous Values F3: Optimized Defaults F4: Save & Exit ESC: Exit
Version 2.21.1278 Copyright (C) 2021 AMI		

Options Summary		
<b>Security Device Support</b>	Enable	Optimal Default, Failsafe Default
	Disable	
Enables or Disables BIOS support for security device. O.S. will not show Security Device. TCG EFI protocol and INT1A interface will not be available.		
<b>SHA-1 PCR Bank</b>	Disabled	Optimal Default, Failsafe Default
	Enabled	
Enable or Disable SHA-1 PCR Bank.		
<b>SHA256 PCR Bank</b>	Enabled	Optimal Default, Failsafe Default
	Disabled	
Enable or Disable SHA256 PCR Bank.		
<b>SHA384 PCR Bank</b>	Enabled	Optimal Default, Failsafe Default
	Disabled	
Enable or Disable SHA384 PCR Bank.		
<b>SM3_256 PCR Bank</b>	Enabled	Optimal Default, Failsafe Default
	Disabled	
Enable or Disable SM3_256 PCR Bank.		

Options Summary		
Pending operation	None	Optimal Default, Failsafe Default
	TPM Clear	
Schedule an Operation for the Security Device. <b>Note:</b> Your Computer will reboot during restart in order to change State of Security Device.		
Platform Hierarchy	Enabled	Optimal Default, Failsafe Default
	Disabled	
Enable or Disable Platform Hierarchy.		
Storage Hierarchy	Enabled	Optimal Default, Failsafe Default
	Disabled	
Enable or Disable Storage Hierarchy.		
Endorsement Hierarchy	Enabled	Optimal Default, Failsafe Default
	Disabled	
Enable or Disable Endorsement Hierarchy.		
TPM 2.0 UEFI Spec Version	TCG_2	Optimal Default, Failsafe Default
	TCG_1_2	
Select the TCH2 Spec Version Support. TCG_1_2: The Compatible mode for Win8/Win10. TCG_2: Support new TCG2 protocol and event format for Win10 or later.		
Physical Presence Spec Version	1.3	Optimal Default, Failsafe Default
	1.2	
Select to Tell O.S. to support PPI Spec Version 1.2 or 1.3. Note some HCK tests might not support 1.3.		
Device Select	Auto	Optimal Default, Failsafe Default
	TPM 1.2	
	TPM 2.0	
TPM 1.2 will restrict support to TPM 1.2 devices, TPM 2.0 will restrict support to TPM 2.0 devices, Auto will support both with the default set to TPM 2.0 devices if not found, TPM 1.2 devices will be enumerated.		

## 3.4.2 NVMe Configuration

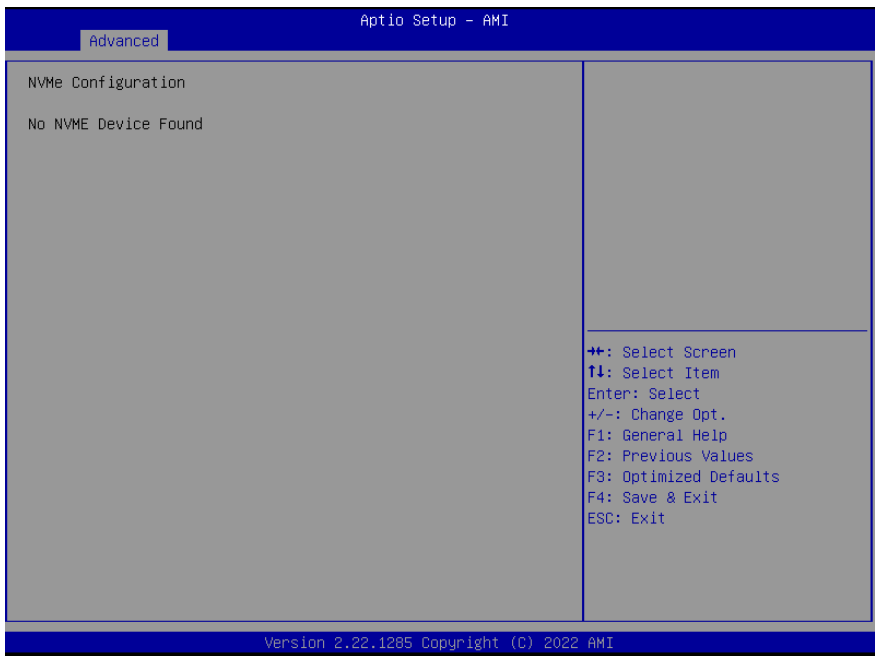



### 3.4.3 Hardware Monitor

Aptio Setup - AMI

Advanced

<p>Pc Health Status</p> <p>CPU Temperature : +42 ℃            System Temperature : +39 ℃            System Temperature 2 : +37 ℃</p> <p>System FAN : 3823 RPM</p> <p>5VSB : +4.910 V            +12V : +11.533 V            VMEM : +1.202 V            VCORE : +1.780 V            P1V05 : +1.055 V</p> <p>▶ Fan 1 Mode Configuration</p>	<p>Smart Fan Configuration</p> <hr/> <p>             ++: Select Screen              ↑↓: Select Item              Enter: Select              +/-: Change Opt.              F1: General Help              F2: Previous Values              F3: Optimized Defaults              F4: Save &amp; Exit              ESC: Exit           </p>
---	--

Version 2.22.1285 Copyright (C) 2022 AMI

Options Summary		
<b>System Fan</b>	Full Mode	Optimal Default, Failsafe Default
	Manual Mode by PWM	
	Auto Mode by PWM	
<b>PWM signal</b>	Non-inverting	Optimal Default, Failsafe Default
	Inverting	
Select output PWM of inverting or non-uninverting signal.		

### 3.4.4 SIO Configuration

Aptio Setup - AMI

Advanced

AMI SIO Driver Version : A5.17.00

Super IO Chip Logical Device(s) Configuration

- ▶ [\*Active\*] Serial Port 1
- ▶ [\*Active\*] Serial Port 2

WARNING: Logical Devices state on the left side of the control, reflects the current Logical Device state. Changes made during Setup Session will be shown after you restart the system.

View and Set Basic properties of the SIO Logical device. Like IO Base, IRQ Range, DMA Channel and Device Mode.

++: Select Screen  
F4: Select Item  
Enter: Select  
+/-: Change Opt.  
F1: General Help  
F2: Previous Values  
F3: Optimized Defaults  
F4: Save & Exit  
ESC: Exit

Version 2.22.1285 Copyright (C) 2022 AMI

### 3.4.5 Serial Port Configuration

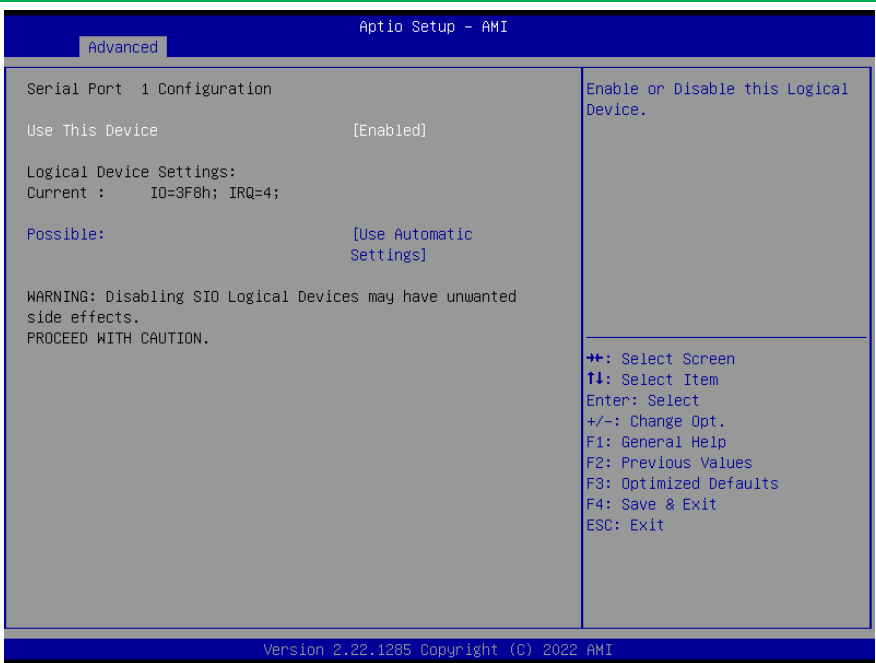

Options Summary		
Use This Device	Disable	
	Enable	Optimal Default, Failsafe Default
Enable or Disable this Logical Device.		
Possible:	Use Automatic Settings	Optimal Default, Failsafe Default
	IO=3F8h; IRQ=4	
	IO=2F8h; IRQ=3	
Allows user to change Device's Resource settings. New settings will be reflected on This Setup Page after System restarts.		

### 3.4.6 Serial Port Console Redirection

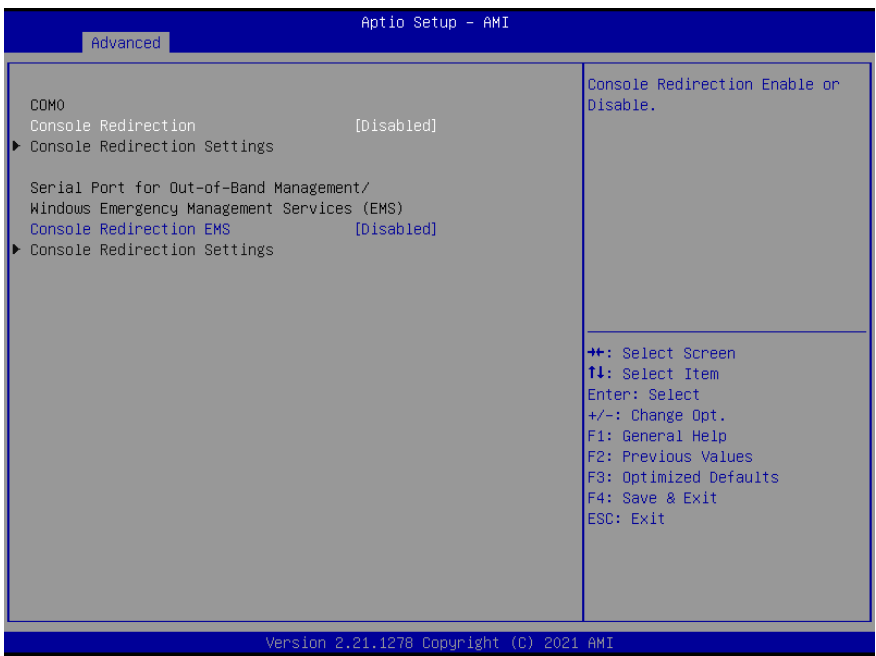

Options Summary		
Console Redirection	Disabled	Optimal Default, Failsafe Default
	Enabled	
Console Redirection Enable or Disable.		
Console Redirection EMS	Disabled	Optimal Default, Failsafe Default
	Enabled	
Console Redirection Enable or Disable.		

### 3.4.7 AAEON BIOS Robot

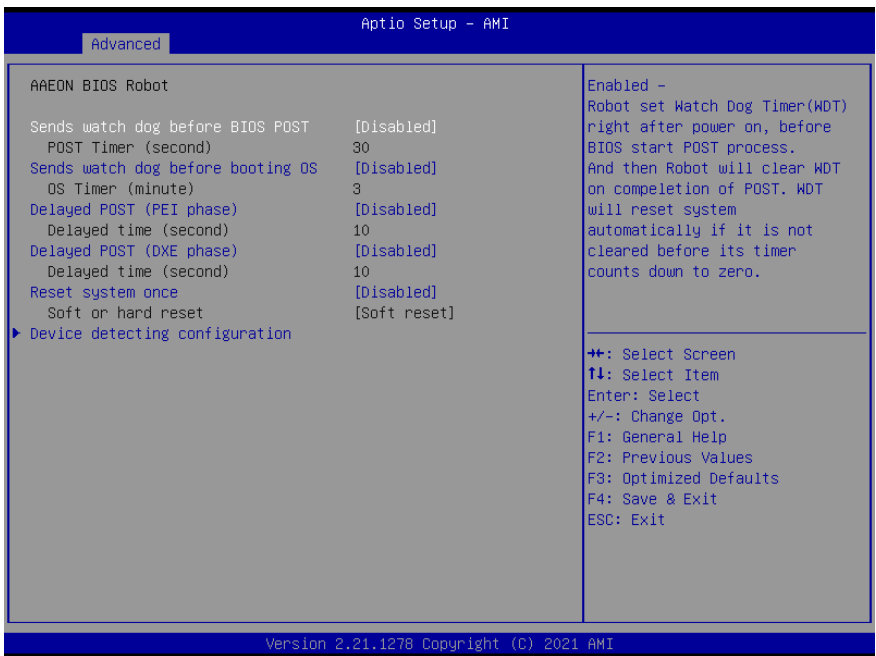

Options Summary		
Sends watch dog before BIOS POST	Disabled	Optimal Default, Failsafe Default
	Enabled	
Enabled - Robot set Watch Dog Timer (WDT) right after power on, before BIOS start POST process. And then Robot will clear WDT on completion of POST. WDT will reset system automatically if it is not cleared before its timer counts down to zero.		
POST Timer (second)	30	Optimal Default, Failsafe Default
Timer count set to Watch Dog Timer for POST. <b>Warning:</b> Do not set to a value equal or shorter than normal POST time, otherwise system may never complete POST unless clearing BIOS settings. More than 2 x normal POST time is suggested.		
Sends watch dog before booting OS	Disabled	Optimal Default, Failsafe Default
	Enabled	
Enabled - Robot set Watch Dog Timer (WDT) after POST completion, before BIOS transfer control to OS. <b>Warning:</b> Before enabling this function, a program in OS must be in responsible for clearing WDT. Also, this function should be disabled if OS is going to update itself.		

Options Summary		
OS Timer (minute)	3	Optimal Default, Failsafe Default
Timer count set to Watch Dog Timer for OS loading.		
Delayed POST (PEI phase)	Disabled	Optimal Default, Failsafe Default
	Enabled	
Enabled - Robot holds BIOS from starting POST, right after power on. This allows BIOS POST to start with stable power or start after system is physically warmed-up. <b>Note:</b> Robot does this before 'Sends watch dog'.		
Delayed time (second)	10	Optimal Default, Failsafe Default
Period of time for Robot to hold BIOS from POST.		
Delayed POST (DXE phase)	Disabled	Optimal Default, Failsafe Default
	Enabled	
Enabled - Robot holds BIOS before POST completion. This allows BIOS POST to start with stable power or start after system is physically warmed-up. <b>Note:</b> Robot does this after 'Sends watch dog before BIOS POST'.		
Delayed time (second)	10	Optimal Default, Failsafe Default
Period of time for Robot to hold BIOS from POST.		
Reset system once	Disabled	Optimal Default, Failsafe Default
	Enabled	
Enabled - Robot resets system for one time on each boot. This will send a soft or hard reset to onboard devices, thus puts devices to more stable state.		
Soft or hard reset	Soft reset	Optimal Default, Failsafe Default
	Hard reset"	
Select reset type robot should send on each boot.		

### 3.4.8 Power Management

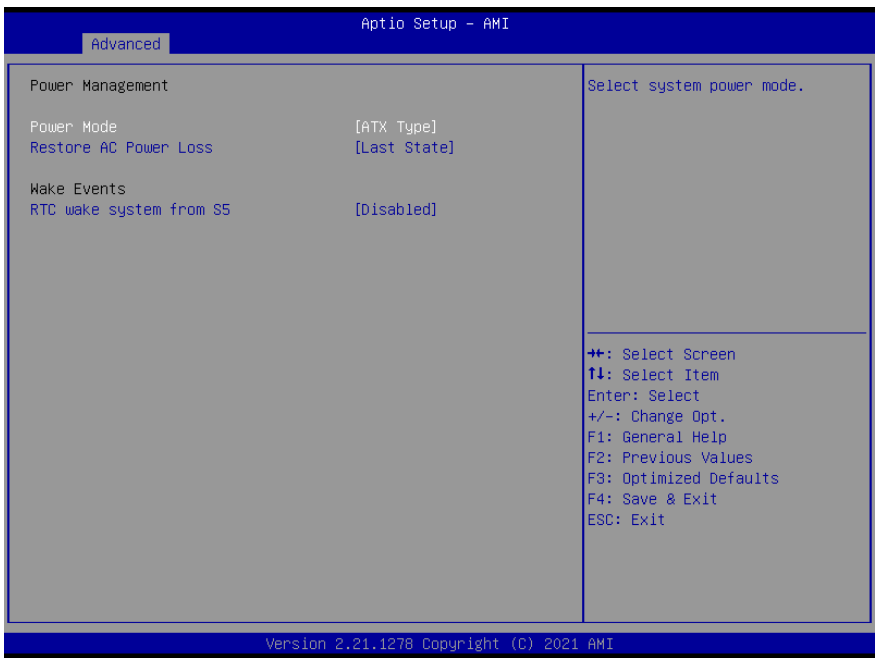

Options Summary		
Power Mode	ATX Type	Optimal Default, Failsafe Default
	AT Type	
Select power supply mode.		
Restore AC Power Loss	Last State	Optimal Default, Failsafe Default
	Always On	
	Always Off	
Select power state when power is re-applied after a power failure.		
RTC wake system from S5	Disable	Optimal Default, Failsafe Default
	Fixed Time	
Fixed Time: System will wake on the hr::min::sec specified.		
Dynamic Time: System will wake on the current time + Increase minute(s).		

### 3.4.9 Digital IO Port Configuration

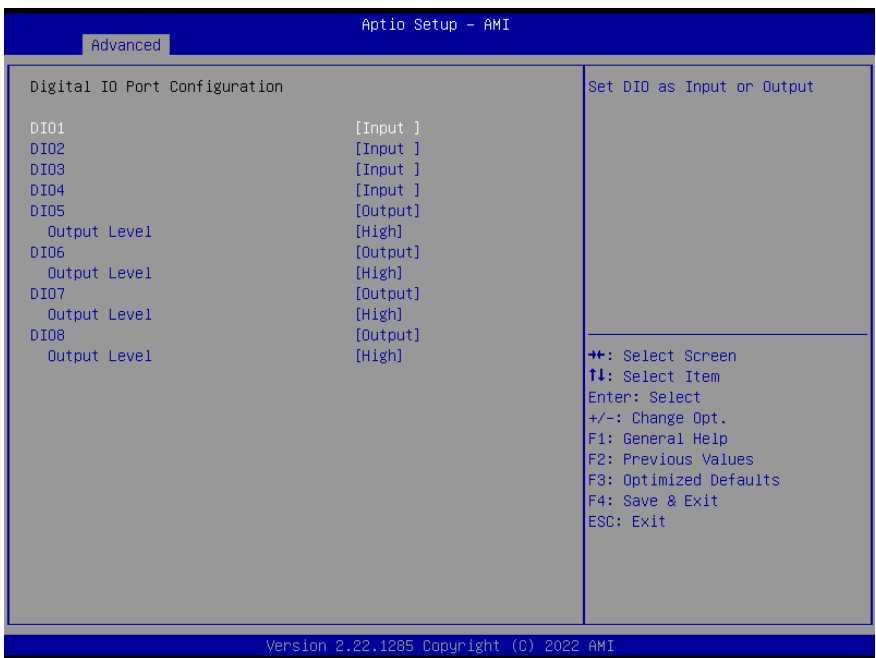

Options Summary		
DIO Port*	Output	
	Input	
Set DIO as Input or Output.		
Output Level	High	
	Low	
Set output level when DIO pin is output.		



### 3.5 Setup Submenu: Platform Configuration

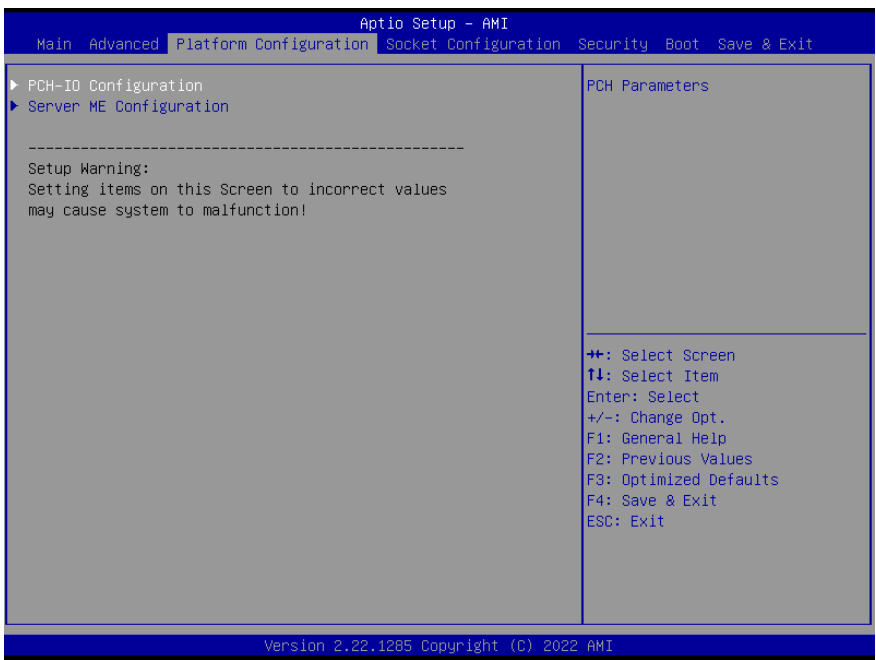

### 3.5.1 PCH-IO Configuration

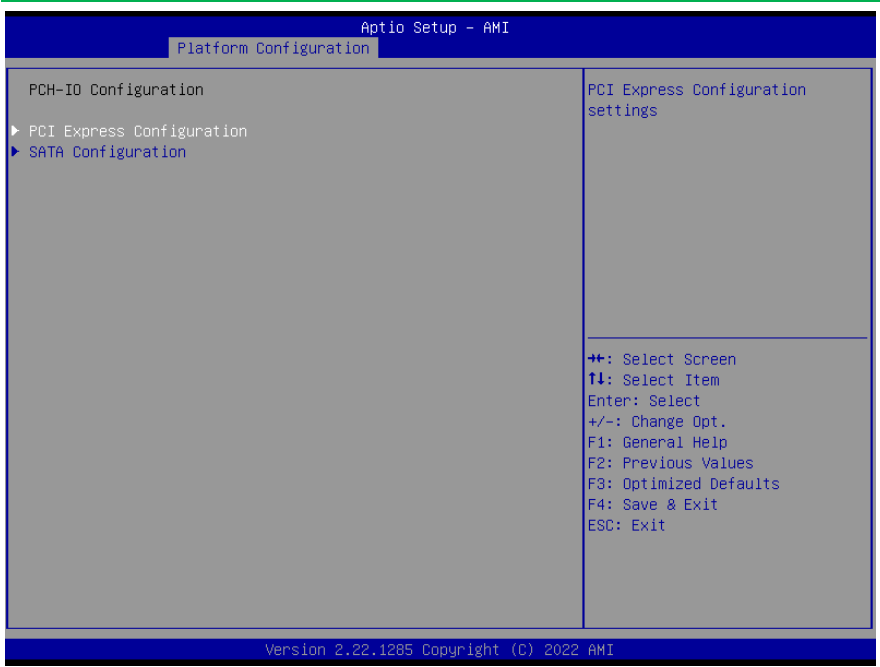

### 3.5.2 PCI Express Configuration

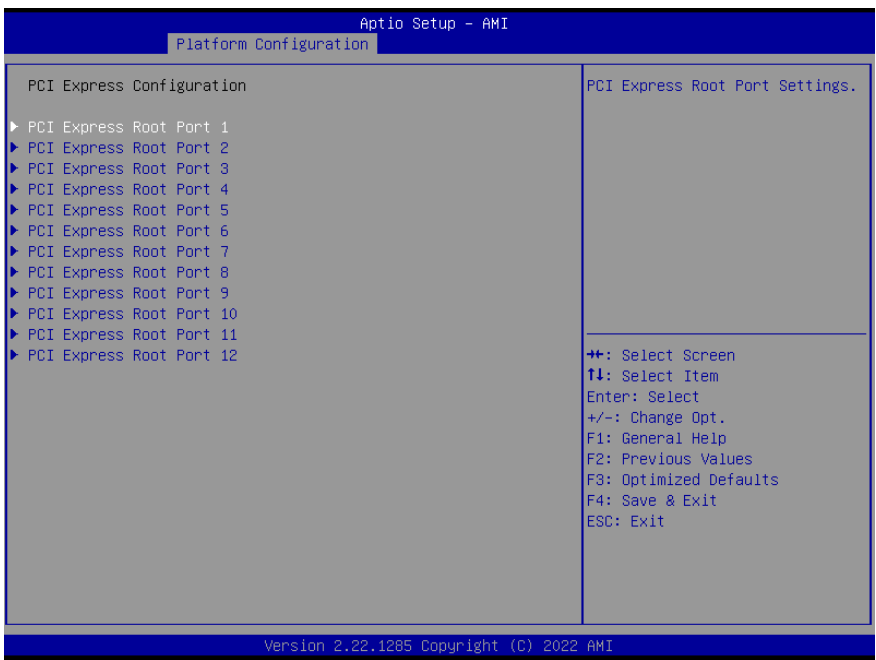

Options Summary		
PCI Express Root Port*	Disabled	
	Enabled	Optimal Default, Failsafe Default
Control the PCI Express Root Port.		
ASPM	Disabled	
	Enabled	Optimal Default, Failsafe Default
Control the PCI Express Root Port.		
PCI Express Root Port*	Disabled	Optimal Default, Failsafe Default
	L0s	
	L1	
	L0sL1	
	Auto	
PCI Express Active State Power Management settings.		
Hot Plug	Disabled	Optimal Default, Failsafe Default
	Enabled	
PCI Express Hot Plug Enable/Disable.		

## Options Summary

PCIe Speed	Gen1	
	Gen2	
	Gen3	Optimal Default, Failsafe Default
Configure PCIe Speed Auto is equal to Gen2 or Gen3 depending on DTR soft strap.		

## 3.5.3 SATA Configuration

The screenshot shows the 'Aptio Setup - AMI' interface with the 'Platform Configuration' tab selected. The 'SATA Controller Configuration' section is expanded, showing the following settings:

- SATA Configuration: [Enabled]
- SATA Port 0: [Not Installed]
  - Port 0: [Enabled]
  - Hot Plug: [Disabled]
- SATA Port 1: HGST HTE725032 - 320.0 GB
  - Port 1: [Enabled]
  - Hot Plug: [Disabled]

The 'SATA test settings' section is also visible, containing the following options:

- ++: Select Screen
- f1: Select Item
- Enter: Select
- +/-: Change Opt.
- F1: General Help
- F2: Previous Values
- F3: Optimized Defaults
- F4: Save & Exit
- ESC: Exit

At the bottom of the screen, the version information is displayed: 'Version 2.22.1285 Copyright (C) 2022 AMI'.

## Options Summary

SATA Configuration	Enabled	Optimal Default, Failsafe Default
	Disabled	
SATA test settings.		
Port*	Enabled	Optimal Default, Failsafe Default
	Disabled	
Enable or Disable SATA Port.		
Hot Plug	Enabled	
	Disabled	Optimal Default, Failsafe Default
Designates this port as Hot Pluggable.		

### 3.5.4 Server ME Configuration

The screenshot shows the 'Platform Configuration' screen in the Aptio Setup - AMI BIOS. The 'General ME Configuration' section is expanded, displaying the following information:

Oper. Firmware Version	11:5.0.4.17
Backup Firmware Version	N/A
Recovery Firmware Version	11:5.0.4.17
ME Firmware Status #1	0x00000245
ME Firmware Status #2	0x89116026
Current State	Operational
Error Code	No Error
Recovery Cause	N/A

Navigation instructions are listed in the bottom right corner:

- ++: Select Screen
- ↑↓: Select Item
- Enter: Select
- +/-: Change Opt.
- F1: General Help
- F2: Previous Values
- F3: Optimized Defaults
- F4: Save & Exit
- ESC: Exit

At the bottom of the screen, the text reads: 'Version 2.22.1285 Copyright (C) 2022 AMI'.

### 3.6 Setup Submenu: Socket Configuration

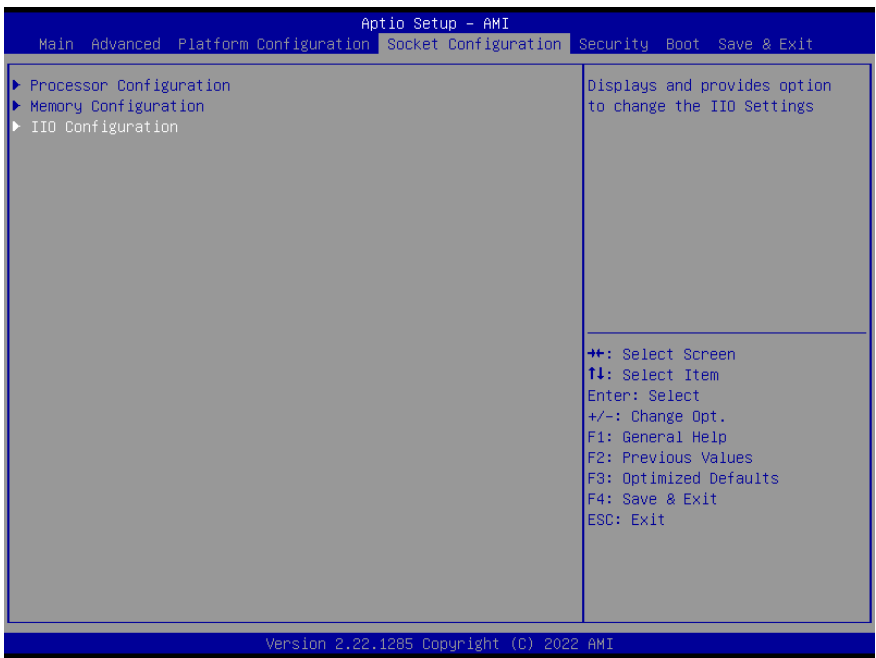

### 3.6.1 Processor Configuration

Aptio Setup - AMI		
Socket Configuration		
Processor Configuration		Enables Hyper Threading (Software Method to Enable/Disable Logical Processor threads).
-----		
Processor BSP Revision	606C1 - ICX-D LCC B	
Processor Socket	Socket 0	Socket 1
Processor ID	000606C1*	
Processor Frequency	2.000GHz	
Processor Max Ratio	14H	
Processor Min Ratio	08H	
Microcode Revision	010001A0	
L1 Cache RAM(Per Core)	80KB	
L2 Cache RAM(Per Core)	1280KB	
L3 Cache RAM(Per Package)	15360KB	
Processor 0 Version	Intel(R) Xeon(R) D-1746 TER CPU @ 2.00GHz	
Hyper-Threading [ALL]	[Enable]	
++: Select Screen T1: Select Item Enter: Select +/-: Change Opt. F1: General Help F2: Previous Values F3: Optimized Defaults F4: Save & Exit ESC: Exit		
Version 2.22.1285 Copyright (C) 2022 AMI		

Options Summary		
Hyper-Threading [ALL]	Disable	
	Enable	Optimal Default, Failsafe Default
Enable Hyper Threading (Software Method to Enable/Disable Logical Processor threads).		

### 3.6.2 Memory Configuration

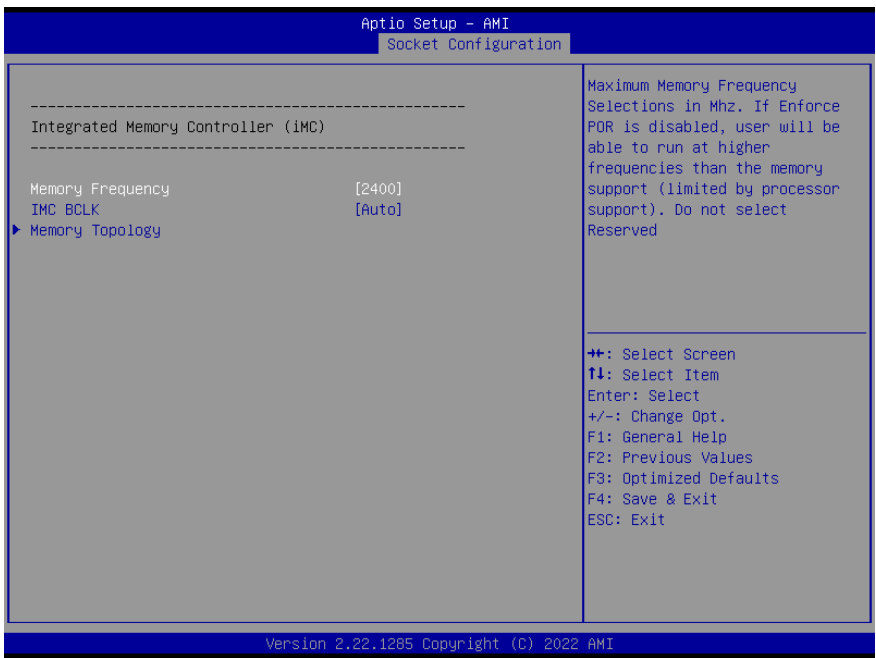

Options Summary		
Memory Frequency	2400	Optimal Default, Failsafe Default
	2666	
	2933	
Maximum Memory Frequency Selections in Mhz. If Enforce POR is disabled, user will be able to run at higher frequencies than the memory support (limited by processor support). Do not select Reserved.		



### 3.6.3 Memory Topology

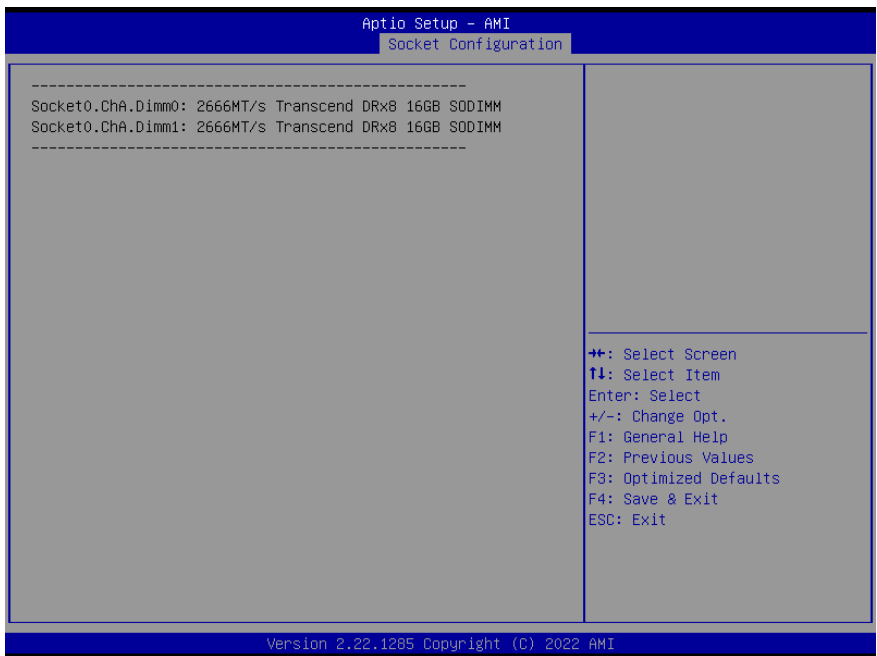

## 3.6.4 IIO Configuration



### 3.6.5 Socket0 Configuration



Options Summary		
IOU0 (IIO PCIe Port 1)	Auto	Optimal Default, Failsafe Default
	X4X4X4X4	
	X4X4X8	
	X8X4X4	
	X8X8	
	X16	
Selects PCIe port Bifurcation for selected slot(s).		

## 3.7 Setup Submenu: Security

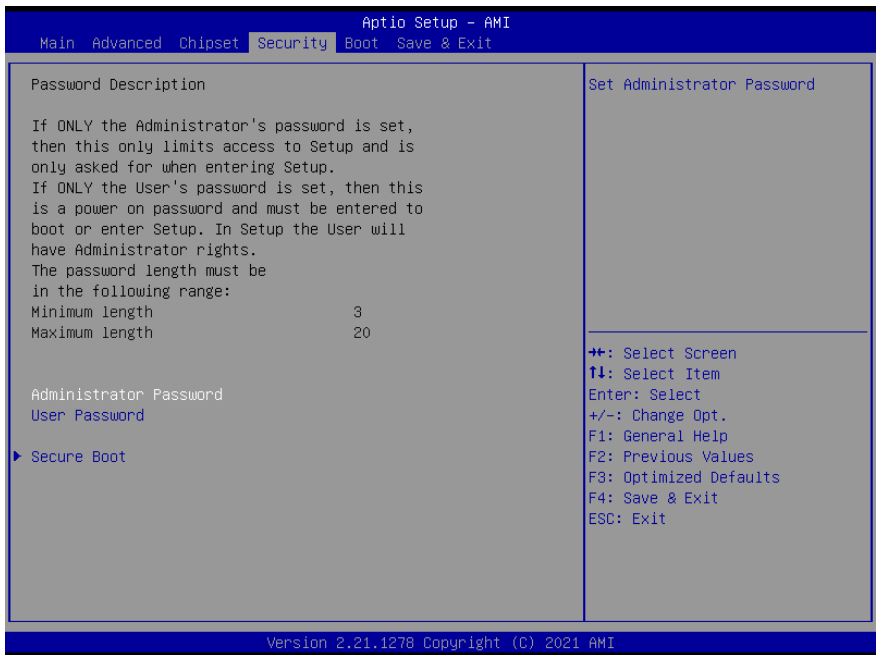

### Change User/Supervisor Password

You can install a Supervisor password, and if you install a supervisor password, you can then install a user password. A user password does not provide access to many of the features in the Setup utility.

If you highlight these items and press Enter, a dialog box appears which lets you enter a password. You can enter no more than six letters or numbers. Press Enter after you have typed in the password. A second dialog box asks you to retype the password for confirmation. Press Enter after you have retyped it correctly. The password is required at boot time, or when the user enters the Setup utility.

### Removing the Password

Highlight this item and type in the current password. At the next dialog box press Enter to disable password protection.

### 3.7.1 Secure Boot



Options Summary		
Secure Boot	Disabled	Optimal Default, Failsafe Default
	Enabled	
Secure Boot feature is Active if Secure Boot is Enabled, Platform Key (PK) is enrolled and the System is in User mode. The mode change requires platform reset.		
Secure Boot Mode	Custom	Optimal Default, Failsafe Default
	Standard	
Secure Boot mode options: Standard or Custom. In Custom mode, Secure Boot Policy variables can be configured by a physically present user without full authentication.		
Restore Factory Keys		
Force System to User Mode. Install factory default Secure Boot key databases.		
Reset to Setup Mode		
Delete all Secure Boot key databases from NVRAM.		



Options Summary	
Remove 'UEFI CA' from DB	
Device Guard ready system must not list 'Microsoft UEFI CA' Certificate in Authorized Signature database (db).	
Restore DB defaults	
Restore DB variable to factory defaults	
Platform Key (PK)	Details
	Export
	Update
	Delete
Key Exchange Keys	Details
	Export
	Update
	Append
	Delete
Authorized Signatures	Details
	Export
	Update
	Append
	Delete
Forbidden Signatures	Details
	Export
	Update
	Append
	Delete
Authorized Timestamps	Update
	Append
OS Recovery Signatures	Update
	Append
Enroll Factory Defaults or load certificates from a file:	
1.Public Key Certificate:	
a) EFI_SIGNATURE_LIST	
b) EFI_CERT_X509 (DER)	
c) EFI_CERT_RSA2048 (bin)	
d) EFI_CERT_SHAXXX	
2.Authenticated UEFI Variable	
3.EFI PE/COFF Image (SHA256)	
Key Source: Factory, External, Mixed	

### 3.8 Setup Submenu: Boot

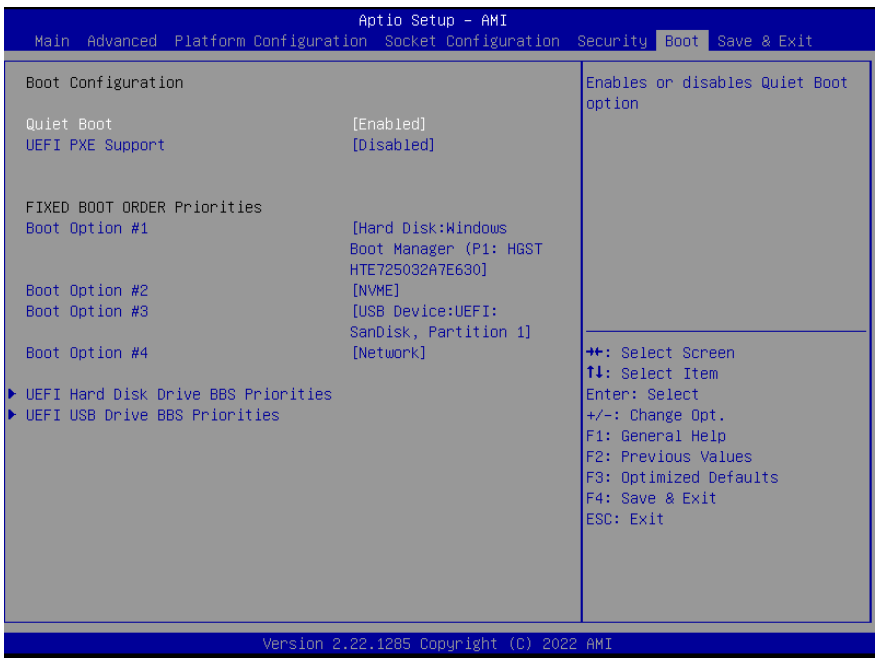

Options Summary		
Quiet Boot	Disabled	
	Enabled	Optimal Default, Failsafe Default
Enable or Disable Quiet Boot option.		
UEFI PXE Support	Disabled	Optimal Default, Failsafe Default
	Enabled	
Enable/Disable UEFI Network Stack.		
FIXED BOOT ORDER Priorities		Sets the system boot order



### 3.8.1 BBS Priorities

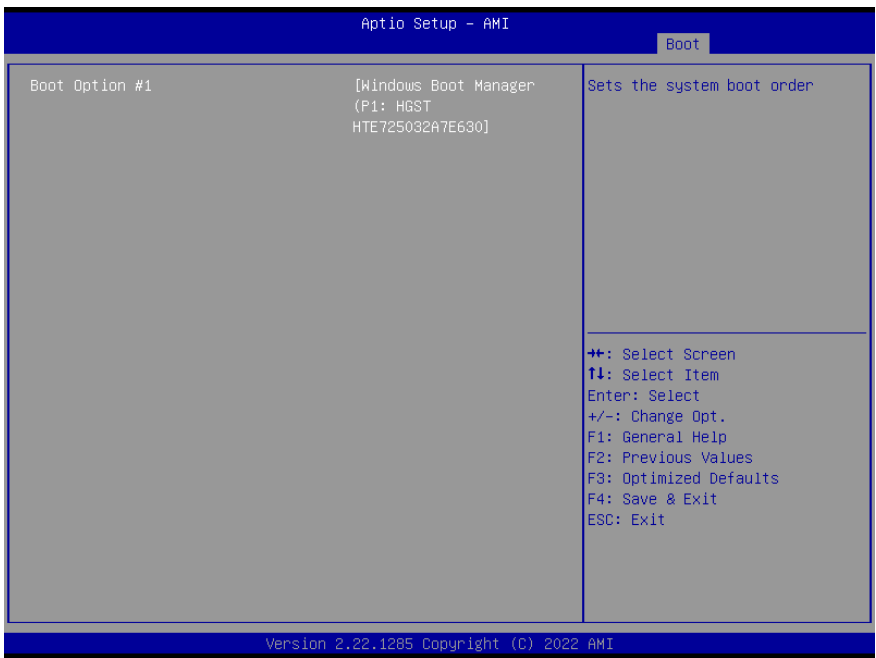

### 3.9 Setup Submenu: Save & Exit

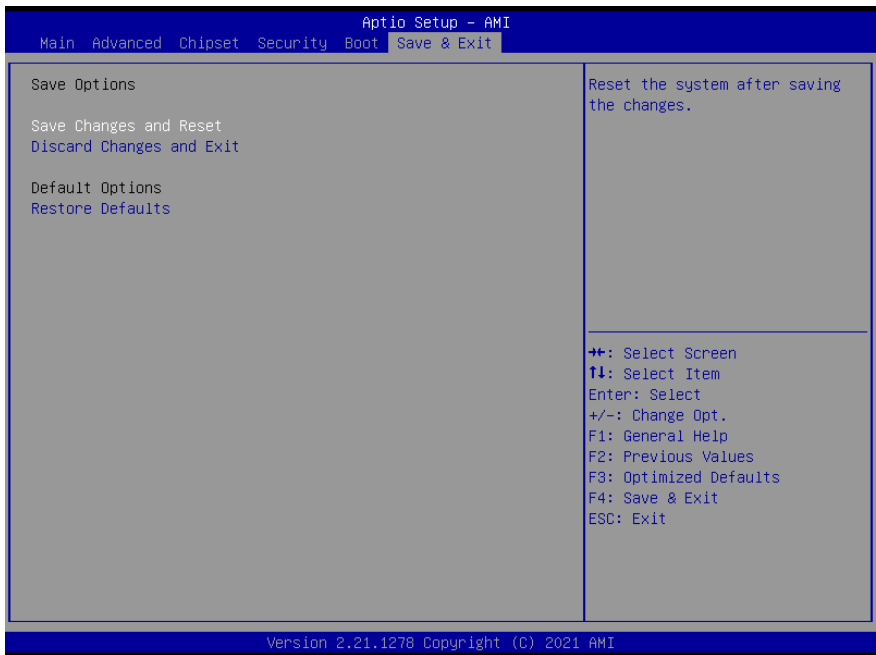

Options Summary	
Save Changes and Reset	Reset the system after saving the changes.
Discard Changes and Exit	Exit system setup without saving any changes.
Restore Defaults	Restore/Load Default values for all the setup options.

# Chapter 4

---

Drivers Installation

## 4.1 Drivers Download and Installation

---

Drivers for the COM-ICDB7 can be downloaded from the product page on the AAEON website by following this link:

<https://www.aaeon.com/en/p/com-express-cpu-modules-com-icdb7>

Download the driver(s) you need and follow the steps below to install them.

### Chipset Driver (Windows 10)

1. Open the folder where you unzipped the **Chipset Drivers**
2. Run the **SetupChipset.exe** file in the folder
3. Follow the instructions
4. Drivers will be installed automatically

### LAN Driver (Windows 10)

1. Open the folder where you unzipped the **LAN Drivers**
2. Click the **ProWinx64.exe** file in the folder.
3. Follow the instructions
4. Drivers will be installed automatically

### Network Adapter Driver (Windows 10)

1. Open the folder where you unzipped the **Network Adapter Drivers**
2. Click the **Autorun.exe** file in the folder.
3. Follow the instructions
4. Drivers will be installed automatically











# Appendix A

---

I/O Information

## A.1 I/O Address Map

Input/output (I/O)	
[0000000000000000 - 000000000000000F]	Direct memory access controller
[0000000000000000 - 0000000000000CF7]	PCI Express Root Complex
[0000000000000010 - 000000000000001F]	Motherboard resources
[0000000000000020 - 000000000000003D]	Programmable interrupt controller
[0000000000000040 - 0000000000000043]	System timer
[0000000000000050 - 0000000000000053]	System timer
[0000000000000061 - 0000000000000061]	System speaker
[0000000000000070 - 0000000000000071]	System CMOS/real time clock
[0000000000000072 - 0000000000000073]	System CMOS/real time clock
[0000000000000074 - 0000000000000077]	System CMOS/real time clock
[0000000000000080 - 0000000000000080]	Motherboard resources
[0000000000000081 - 0000000000000083]	Direct memory access controller
[0000000000000084 - 0000000000000086]	Motherboard resources
[0000000000000087 - 0000000000000087]	Direct memory access controller
[0000000000000088 - 0000000000000088]	Motherboard resources
[0000000000000089 - 000000000000008B]	Direct memory access controller
[000000000000008C - 000000000000008E]	Motherboard resources
[000000000000008F - 000000000000008F]	Direct memory access controller
[0000000000000090 - 000000000000009F]	Motherboard resources
[00000000000000A0 - 00000000000000BD]	Programmable interrupt controller
[00000000000000C0 - 00000000000000DF]	Direct memory access controller
[00000000000000F0 - 00000000000000F0]	Numeric data processor
[00000000000002F8 - 00000000000002FF]	Communications Port (COM2)
[00000000000003F8 - 00000000000003FF]	Communications Port (COM2)
[00000000000003F8 - 00000000000003FF]	Communications Port (COM1)
[0000000000000400 - 000000000000041F]	Motherboard resources
[00000000000004D0 - 00000000000004D1]	Programmable interrupt controller
[0000000000000500 - 00000000000005FE]	Motherboard resources
[0000000000000500 - 00000000000005FE]	Motherboard resources
[0000000000001000 - 0000000000005FFF]	PCI Express Root Complex
[0000000000004000 - 0000000000004FFF]	CDF PCIeRP[9] - 18AE
[0000000000005020 - 000000000000503F]	Standard SATA AHCI Controller
[0000000000005040 - 0000000000005047]	CDF HSUART - 18D8 (COM5)
[0000000000005050 - 0000000000005057]	CDF HSUART - 18D8 (COM4)
[0000000000005060 - 0000000000005067]	CDF HSUART - 18D8 (COM3)
[0000000000005070 - 0000000000005073]	Standard SATA AHCI Controller
[0000000000005080 - 0000000000005087]	Standard SATA AHCI Controller
[0000000000006000 - 000000000000AFFF]	PCI Express Root Complex
[000000000000A000 - 000000000000A07F]	NVIDIA GeForce GT 1030
[000000000000A000 - 000000000000AFFF]	Intel(R) PCI Express Root Port A - 347A
[000000000000B000 - 000000000000FFFF]	PCI Express Root Complex









































	[0000000000004000 - 0000000000004FFF]	CDF PCIeRP[9] - 18AE
	[0000000000005020 - 000000000000503F]	Standard SATA AHCI Controller
	[0000000000005040 - 0000000000005047]	CDF HSUART - 18D8 (COM5)
	[0000000000005050 - 0000000000005057]	CDF HSUART - 18D8 (COM4)
	[0000000000005060 - 0000000000005067]	CDF HSUART - 18D8 (COM3)
	[0000000000005070 - 0000000000005073]	Standard SATA AHCI Controller
	[0000000000005080 - 0000000000005087]	Standard SATA AHCI Controller
	[0000000000006000 - 000000000000AFFF]	PCI Express Root Complex
	[000000000000A000 - 000000000000A07F]	NVIDIA GeForce GT 1030
	[000000000000A000 - 000000000000AFFF]	Intel(R) PCI Express Root Port A - 347A
	[000000000000B000 - 000000000000FFFF]	PCI Express Root Complex









































## A.2 Memory Address Map

















Memory
[0000000000A0000 - 0000000000BFFFF] PCI Express Root Complex
[0000000000C8000 - 0000000000CFFFF] PCI Express Root Complex
[0000000009000000 - 000000000B3FFFFFF] PCI Express Root Complex
[00000000B3D00000 - 00000000B3D1FFFF] Intel(R) I210 Gigabit Network Connection
[00000000B3D00000 - 00000000B3DFFFFFF] CDF PCIeRP[9] - 18AE
[00000000B3D20000 - 00000000B3D23FFF] Intel(R) I210 Gigabit Network Connection
[00000000B3E80000 - 00000000B3EFFFFFF] Intel (R) PMON MSM Registers - 09A7
[00000000B3F00000 - 00000000B3F7FFF] Intel (R) PMON MSM Registers - 09A7
[00000000B3F80000 - 00000000B3F81FFF] Standard SATA AHCI Controller
[00000000B3F82000 - 00000000B3F83FFF] Intel (R) MSM Registers - 09A6
[00000000B3F87000 - 00000000B3F87FFF] Standard SATA AHCI Controller
[00000000B3F88000 - 00000000B3F880FF] Standard SATA AHCI Controller
[00000000B3FFFD00 - 00000000B3FFFDFF] CDF HSUART - 18D8 (COM3)
[00000000B3FFFE00 - 00000000B3FFFEFF] CDF HSUART - 18D8 (COM4)
[00000000B3FFFF00 - 00000000B3FFFFFF] CDF HSUART - 18D8 (COM5)
[00000000B4000000 - 00000000D7FFFFFF] PCI Express Root Complex
[00000000D6000000 - 00000000D70FFFF] Intel(R) PCI Express Root Port A - 347A
[00000000D70FC000 - 00000000D70FFFF] High Definition Audio Controller
[00000000D8000000 - 00000000FB7FFFF] PCI Express Root Complex
[00000000FB300000 - 00000000FB6FFFF] PCI Express Root Port
[00000000FD000000 - 00000000FD69FFF] Motherboard resources
[00000000FD6F0000 - 00000000FDFFFFF] Motherboard resources
[00000000FDC20000 - 00000000FDC21FFF] Unknown device
[00000000FDC50000 - 00000000FDC51FFF] Unknown device
[00000000FE000000 - 00000000FE01FFFF] Motherboard resources
[00000000FE010000 - 00000000FE010FFF] CDF SPI - 18E0
[00000000FE010000 - 00000000FE010FFF] PCI Express Root Complex
[00000000FE200000 - 00000000FE7FFFF] Motherboard resources
[00000000FEC00000 - 00000000FECFFFF] Advanced programmable interrupt controller
[00000000FED00000 - 00000000FED003FF] High precision event timer
[00000000FED40000 - 00000000FED44FFF] Trusted Platform Module 2.0
[00000000FF000000 - 00000000FFFFFFF] Motherboard resources
[00000000FF000000 - 00000000FFFFFFF] Motherboard resources
[00000020FFFA00000 - 0000020FFFA1FFFF] CDF PCIeRP[9] - 18AE
[0000020FFFA40000 - 0000020FFFA4FFFF] Intel(R) USB 3.0 eXtensible Host Controller - 1.0 (Microsoft)
[0000020FFFA77000 - 0000020FFFA77FFF] CDF ME:HECI#3 - 18D6
[0000020FFFA78000 - 0000020FFFA78FFF] CDF ME:HECI#2 - 18D4
[0000020FFFA79000 - 0000020FFFA79FFF] CDF ME:HECI#1 - 18D3
[0000021FFFF00000 - 0000021FFFF1FFFF] Intel(R) PCI Express Root Port A - 347A
[0000022FD8000000 - 0000022FDFFFFFF] Intel(R) Ethernet Connection E823-L/X557-AT 10GBASE-T #3
[0000022FD8000000 - 0000022FFC4FFFF] PCI Express Root Port
[0000022FE0000000 - 0000022FE7FFFFF] Intel(R) Ethernet Connection E823-L/X557-AT 10GBASE-T #2
[0000022FEB000000 - 0000022FEBFFFFFF] Intel(R) Ethernet Connection E823-L/X557-AT 10GBASE-T
[0000022FF0000000 - 0000022FF7FFFFF] Intel(R) Ethernet Connection E823-L/X557-AT 10GBASE-T #4
[0000022FFC4C0000 - 0000022FFC4CFFF] Intel(R) Ethernet Connection E823-L/X557-AT 10GBASE-T #3
[0000022FFC4D0000 - 0000022FFC4DFFF] Intel(R) Ethernet Connection E823-L/X557-AT 10GBASE-T #2
[0000022FFC4E0000 - 0000022FFC4EFFF] Intel(R) Ethernet Connection E823-L/X557-AT 10GBASE-T
[0000022FFC4F0000 - 0000022FFC4FFFF] Intel(R) Ethernet Connection E823-L/X557-AT 10GBASE-T #4



## A.3 IRQ Mapping Chart

▼		Interrupt request (IRQ)	
		(ISA) 0x00000000 (00)	System timer
		(ISA) 0x00000003 (03)	Communications Port (COM2)
		(ISA) 0x00000004 (04)	Communications Port (COM1)
		(ISA) 0x00000004 (04)	Communications Port (COM2)
		(ISA) 0x00000008 (08)	System CMOS/real time clock
		(ISA) 0x0000000D (13)	Numeric data processor
		(ISA) 0x00000015 (21)	Unknown device
		(ISA) 0x00000036 (54)	Microsoft ACPI-Compliant System
		(ISA) 0x00000037 (55)	Microsoft ACPI-Compliant System
		(ISA) 0x00000038 (56)	Microsoft ACPI-Compliant System
		(ISA) 0x00000039 (57)	Microsoft ACPI-Compliant System
		(ISA) 0x0000003A (58)	Microsoft ACPI-Compliant System
		(ISA) 0x0000003B (59)	Microsoft ACPI-Compliant System
		(ISA) 0x0000003C (60)	Microsoft ACPI-Compliant System
		(ISA) 0x0000003D (61)	Microsoft ACPI-Compliant System
		(ISA) 0x0000003E (62)	Microsoft ACPI-Compliant System
		(ISA) 0x0000003F (63)	Microsoft ACPI-Compliant System
		(ISA) 0x00000040 (64)	Microsoft ACPI-Compliant System
		(ISA) 0x00000041 (65)	Microsoft ACPI-Compliant System
		(ISA) 0x00000042 (66)	Microsoft ACPI-Compliant System
		(ISA) 0x00000043 (67)	Microsoft ACPI-Compliant System
		(ISA) 0x00000044 (68)	Microsoft ACPI-Compliant System
		(ISA) 0x00000045 (69)	Microsoft ACPI-Compliant System
		(ISA) 0x00000046 (70)	Microsoft ACPI-Compliant System
		(ISA) 0x00000047 (71)	Microsoft ACPI-Compliant System
		(ISA) 0x00000048 (72)	Microsoft ACPI-Compliant System
		(ISA) 0x00000049 (73)	Microsoft ACPI-Compliant System
		(ISA) 0x0000004A (74)	Microsoft ACPI-Compliant System
		(ISA) 0x0000004B (75)	Microsoft ACPI-Compliant System
		(ISA) 0x0000004C (76)	Microsoft ACPI-Compliant System
		(ISA) 0x0000004D (77)	Microsoft ACPI-Compliant System
		(ISA) 0x0000004E (78)	Microsoft ACPI-Compliant System
		(ISA) 0x0000004F (79)	Microsoft ACPI-Compliant System
		(ISA) 0x00000050 (80)	Microsoft ACPI-Compliant System
		(ISA) 0x00000051 (81)	Microsoft ACPI-Compliant System
		(ISA) 0x00000052 (82)	Microsoft ACPI-Compliant System
		(ISA) 0x00000053 (83)	Microsoft ACPI-Compliant System
		(ISA) 0x00000054 (84)	Microsoft ACPI-Compliant System
		(ISA) 0x00000055 (85)	Microsoft ACPI-Compliant System

 (PCI) 0xFFFFFC2 (-62)	Intel(R) Ethernet Connection E823-L/X557-AT 10GBASE-T #3
 (PCI) 0xFFFFFC3 (-61)	Intel(R) Ethernet Connection E823-L/X557-AT 10GBASE-T #3
 (PCI) 0xFFFFFC4 (-60)	Intel(R) Ethernet Connection E823-L/X557-AT 10GBASE-T #3
 (PCI) 0xFFFFFC5 (-59)	Intel(R) Ethernet Connection E823-L/X557-AT 10GBASE-T #3
 (PCI) 0xFFFFFC6 (-58)	Intel(R) Ethernet Connection E823-L/X557-AT 10GBASE-T #3
 (PCI) 0xFFFFFC7 (-57)	Intel(R) Ethernet Connection E823-L/X557-AT 10GBASE-T #3
 (PCI) 0xFFFFFC8 (-56)	Intel(R) Ethernet Connection E823-L/X557-AT 10GBASE-T #3
 (PCI) 0xFFFFFC9 (-55)	Intel(R) Ethernet Connection E823-L/X557-AT 10GBASE-T #3
 (PCI) 0xFFFFFCA (-54)	Intel(R) Ethernet Connection E823-L/X557-AT 10GBASE-T #3
 (PCI) 0xFFFFFCB (-53)	Intel(R) Ethernet Connection E823-L/X557-AT 10GBASE-T #3
 (PCI) 0xFFFFFCC (-52)	Intel(R) Ethernet Connection E823-L/X557-AT 10GBASE-T #3
 (PCI) 0xFFFFFCD (-51)	Intel(R) Ethernet Connection E823-L/X557-AT 10GBASE-T #2
 (PCI) 0xFFFFFCE (-50)	Intel(R) Ethernet Connection E823-L/X557-AT 10GBASE-T #2
 (PCI) 0xFFFFFCF (-49)	Intel(R) Ethernet Connection E823-L/X557-AT 10GBASE-T #2
 (PCI) 0xFFFFFD0 (-48)	Intel(R) Ethernet Connection E823-L/X557-AT 10GBASE-T #2
 (PCI) 0xFFFFFD1 (-47)	Intel(R) Ethernet Connection E823-L/X557-AT 10GBASE-T #2
 (PCI) 0xFFFFFD2 (-46)	Intel(R) Ethernet Connection E823-L/X557-AT 10GBASE-T #2
 (PCI) 0xFFFFFD3 (-45)	Intel(R) Ethernet Connection E823-L/X557-AT 10GBASE-T #2
 (PCI) 0xFFFFFD4 (-44)	Intel(R) Ethernet Connection E823-L/X557-AT 10GBASE-T #2
 (PCI) 0xFFFFFD5 (-43)	Intel(R) Ethernet Connection E823-L/X557-AT 10GBASE-T #2
 (PCI) 0xFFFFFD6 (-42)	Intel(R) Ethernet Connection E823-L/X557-AT 10GBASE-T #2
 (PCI) 0xFFFFFD7 (-41)	Intel(R) Ethernet Connection E823-L/X557-AT 10GBASE-T #2
 (PCI) 0xFFFFFD8 (-40)	Intel(R) Ethernet Connection E823-L/X557-AT 10GBASE-T
 (PCI) 0xFFFFFD9 (-39)	Intel(R) Ethernet Connection E823-L/X557-AT 10GBASE-T
 (PCI) 0xFFFFFDA (-38)	Intel(R) Ethernet Connection E823-L/X557-AT 10GBASE-T
 (PCI) 0xFFFFFDB (-37)	Intel(R) Ethernet Connection E823-L/X557-AT 10GBASE-T
 (PCI) 0xFFFFFDC (-36)	Intel(R) Ethernet Connection E823-L/X557-AT 10GBASE-T
 (PCI) 0xFFFFFDD (-35)	Intel(R) Ethernet Connection E823-L/X557-AT 10GBASE-T
 (PCI) 0xFFFFFDE (-34)	Intel(R) Ethernet Connection E823-L/X557-AT 10GBASE-T
 (PCI) 0xFFFFFDF (-33)	Intel(R) Ethernet Connection E823-L/X557-AT 10GBASE-T
 (PCI) 0xFFFFFE0 (-32)	Intel(R) Ethernet Connection E823-L/X557-AT 10GBASE-T
 (PCI) 0xFFFFFE1 (-31)	Intel(R) Ethernet Connection E823-L/X557-AT 10GBASE-T
 (PCI) 0xFFFFFE2 (-30)	Intel(R) Ethernet Connection E823-L/X557-AT 10GBASE-T
 (PCI) 0xFFFFFE3 (-29)	Intel(R) Ethernet Connection E823-L/X557-AT 10GBASE-T #4
 (PCI) 0xFFFFFE4 (-28)	Intel(R) Ethernet Connection E823-L/X557-AT 10GBASE-T #4
 (PCI) 0xFFFFFE5 (-27)	Intel(R) Ethernet Connection E823-L/X557-AT 10GBASE-T #4
 (PCI) 0xFFFFFE6 (-26)	Intel(R) Ethernet Connection E823-L/X557-AT 10GBASE-T #4
 (PCI) 0xFFFFFE7 (-25)	Intel(R) Ethernet Connection E823-L/X557-AT 10GBASE-T #4
 (PCI) 0xFFFFFE8 (-24)	Intel(R) Ethernet Connection E823-L/X557-AT 10GBASE-T #4
 (PCI) 0xFFFFFE9 (-23)	Intel(R) Ethernet Connection E823-L/X557-AT 10GBASE-T #4

	(PCI) 0xFFFFFFFFE (-18)	Intel(R) I210 Gigabit Network Connection
	(PCI) 0xFFFFFFFFF (-17)	Intel(R) I210 Gigabit Network Connection
	(PCI) 0xFFFFFFFF0 (-16)	Intel(R) I210 Gigabit Network Connection
	(PCI) 0xFFFFFFFF1 (-15)	Intel(R) I210 Gigabit Network Connection
	(PCI) 0xFFFFFFFF2 (-14)	Intel(R) I210 Gigabit Network Connection
	(PCI) 0xFFFFFFFF3 (-13)	Intel(R) I210 Gigabit Network Connection
	(PCI) 0xFFFFFFFF4 (-12)	Intel(R) I210 Gigabit Network Connection
	(PCI) 0xFFFFFFFF5 (-11)	Intel(R) I210 Gigabit Network Connection
	(PCI) 0xFFFFFFFF6 (-10)	Intel(R) I210 Gigabit Network Connection
	(PCI) 0xFFFFFFFF7 (-9)	Intel(R) I210 Gigabit Network Connection
	(PCI) 0xFFFFFFFF8 (-8)	Intel(R) I210 Gigabit Network Connection
	(PCI) 0xFFFFFFFF9 (-7)	Intel(R) I210 Gigabit Network Connection
	(PCI) 0xFFFFF0FA (-6)	Intel(R) USB 3.0 eXtensible Host Controller - 1.0 (Microsoft)
	(PCI) 0xFFFFF0FB (-5)	Standard SATA AHCI Controller
	(PCI) 0xFFFFF0FC (-4)	PCI Express Root Port
	(PCI) 0xFFFFF0FD (-3)	Intel(R) PCI Express Root Port A - 347A
	(PCI) 0xFFFFF0FE (-2)	CDF PCIeRP[9] - 18AE