

BOXER-8651AI

AI@Edge Compact Fanless Embedded
AI System with NVIDIA[®] Jetson Orin[™] NX

User's Manual 1st Ed

Copyright Notice

This document is copyrighted, 2023. All rights are reserved. The original manufacturer reserves the right to make improvements to the products described in this manual at any time without notice.

No part of this manual may be reproduced, copied, translated, or transmitted in any form or by any means without the prior written permission of the original manufacturer. Information provided in this manual is intended to be accurate and reliable. However, the original manufacturer assumes no responsibility for its use, or for any infringements upon the rights of third parties that may result from its use.

The material in this document is for product information only and is subject to change without notice. While reasonable efforts have been made in the preparation of this document to assure its accuracy, AAEMON assumes no liabilities resulting from errors or omissions in this document, or from the use of the information contained herein.

AAEMON reserves the right to make changes in the product design without notice to its users.

Acknowledgements

All other products' name or trademarks are properties of their respective owners.

- NVIDIA®, the NVIDIA logo, Jetson™, Jetson Orin™ NX, and NVIDIA JetPack™ are trademarks of the NVIDIA Corporation.
- Arm® and Arm®v8-M architecture are registered trademarks of Arm Limited.
- Linux® is the registered trademark of Linus Torvalds in the U.S. and other countries.
- Ubuntu is a registered trademark of Canonical.

All other product names or trademarks are properties of their respective owners. No ownership is implied or assumed for products, names or trademarks not herein listed by the publisher of this document.

Packing List

Before setting up your product, please make sure the following items have been shipped:

Item	Quantity
● BOXER-8651AI	1
● Wallmount Bracket	2
● Screw Package	1
● Power Connector	1
● Power Adapter (Optional)	1
● Power Cord (Optional)	1

If any of these items are missing or damaged, please contact your distributor or sales representative immediately.

About this Document

This User's Manual contains all the essential information, such as detailed descriptions and explanations on the product's hardware and software features (if any), its specifications, dimensions, jumper/connector settings/definitions, and driver installation instructions (if any), to facilitate users in setting up their product.

Users may refer to the product page at AAEON.com for the latest version of this document.

Safety Precautions

Please read the following safety instructions carefully. It is advised that you keep this manual for future references

1. All cautions and warnings on the device should be noted.
2. All cables and adapters supplied by AAEON are certified and in accordance with the material safety laws and regulations of the country of sale. Do not use any cables or adapters not supplied by AAEON to prevent system malfunction or fires.
3. Make sure the power source matches the power rating of the device.
4. Position the power cord so that people cannot step on it. Do not place anything over the power cord.
5. Always completely disconnect the power before working on the system's hardware.
6. No connections should be made when the system is powered as a sudden rush of power may damage sensitive electronic components.
7. If the device is not to be used for a long time, disconnect it from the power supply to avoid damage by transient over-voltage.
8. Always disconnect this device from any power supply before cleaning.
9. While cleaning, use a damp cloth instead of liquid or spray detergents.
10. Make sure the device is installed near a power outlet and is easily accessible.
11. Keep this device away from humidity.
12. Place the device on a solid surface during installation to prevent falls
13. Do not cover the openings on the device to ensure optimal heat dissipation.
14. Watch out for high temperatures when the system is running.
15. Do not touch the heat sink or heat spreader when the system is running
16. Never pour any liquid into the openings. This could cause fire or electric shock.

17. As most electronic components are sensitive to static electrical charge, be sure to ground yourself to prevent static charge when installing the internal components. Use a grounding wrist strap and contain all electronic components in any static-shielded containers.
18. If any of the following situations arises, please the contact our service personnel:
 - i. Damaged power cord or plug
 - ii. Liquid intrusion to the device
 - iii. Exposure to moisture
 - iv. Device is not working as expected or in a manner as described in this manual
 - v. The device is dropped or damaged
 - vi. Any obvious signs of damage displayed on the device
19. **DO NOT LEAVE THIS DEVICE IN AN UNCONTROLLED ENVIRONMENT WITH TEMPERATURES BEYOND THE DEVICE'S PERMITTED STORAGE TEMPERATURES (SEE CHAPTER 1) TO PREVENT DAMAGE.**

FCC Statement

Warning!



This device complies with Part 15 FCC Rules. Operation is subject to the following two conditions: (1) this device may not cause harmful interference, and (2) this device must accept any interference received including interference that may cause undesired operation.

Caution:

There is a danger of explosion if the battery is incorrectly replaced. Replace only with the same or equivalent type recommended by the manufacturer. Dispose of used batteries according to the manufacturer's instructions and your local government's recycling or disposal directives.

Attention:

Il y a un risque d'explosion si la batterie est remplacée de façon incorrecte. Ne la remplacer qu'avec le même modèle ou équivalent recommandé par le constructeur. Recycler les batteries usées en accord avec les instructions du fabricant et les directives gouvernementales de recyclage.

产品中有毒有害物质或元素名称及含量

AAEON System

QO4-381 Rev.A0

部件名称	有毒有害物质或元素					
	铅 (Pb)	汞 (Hg)	镉 (Cd)	六价铬 (Cr(VI))	多溴联苯 (PBB)	多溴二苯 醚(PBDE)
印刷电路板 及其电子组件	×	○	○	○	○	○
外部信号 连接器及线材	×	○	○	○	○	○
外壳	○	○	○	○	○	○
中央处理器 与内存	×	○	○	○	○	○
硬盘	×	○	○	○	○	○
液晶模块	×	×	○	○	○	○
光驱	×	○	○	○	○	○
触控模块	×	○	○	○	○	○
电源	×	○	○	○	○	○
电池	×	○	○	○	○	○

本表格依据 SJ/T 11364 的规定编制。

○：表示该有毒有害物质在该部件所有均质材料中的含量均在 GB/T 26572 标准规定的限量要求以下。

×：表示该有害物质的某一均质材料超出了 GB/T 26572 的限量要求，然而该部件仍符合欧盟指令 2011/65/EU 的规范。

备注：

- 一、此产品所标示之环保使用期限，系指在一般正常使用状况下。
- 二、上述部件物质中央处理器、内存、硬盘、光驱、电源为选购品。
- 三、上述部件物质液晶模块、触控模块仅一体机产品适用。

Hazardous and Toxic Materials List

AAEON System

QO4-381 Rev.A0

Component Name	Hazardous or Toxic Materials or Elements					
	Lead (Pb)	Mercury (Hg)	Cadmium (Cd)	Hexavalent Chromium (Cr(VI))	Polybrominated biphenyls (PBBS)	Polybrominated ethers (PBDES)
PCB and Components	X	O	O	O	O	O
Wires & Connectors for Ext.Connections	X	O	O	O	O	O
Chassis	O	O	O	O	O	O
CPU & RAM	X	O	O	O	O	O
HDD Drive	X	O	O	O	O	O
LCD Module	X	X	O	O	O	O
Optical Drive	X	O	O	O	O	O
Touch Control Module	X	O	O	O	O	O
PSU	X	O	O	O	O	O
Battery	X	O	O	O	O	O

This form is prepared in compliance with the provisions of SJ/T 11364.

O: The level of toxic or hazardous materials present in this component and its parts is below the limit specified by GB/T 26572.

X: The level of toxic of hazardous materials present in the component exceed the limits specified by GB/T 26572, but is still in compliance with EU Directive 2011/65/EU (RoHS 2).

Notes:

1. The Environment Friendly Use Period indicated by labelling on this product is applicable only to use under normal conditions.
2. Individual components including the CPU, RAM/memory, HDD, optical drive, and PSU are optional.
3. LCD Module and Touch Control Module only applies to certain products which feature these components.

Table of Contents

Chapter 1 - Product Specifications	1
1.1 Specifications	2
Chapter 2 – Hardware Information	4
2.1 Dimensions	5
2.2 Jumpers and Connectors.....	6
2.3 List of Jumpers	8
2.3.1 Jumper Settings	8
2.3.2 AT/ATX Mode Selection (CN2).....	9
2.4 List of Connectors.....	10
2.4.1 Front Panel Connector (CN2)	11
2.4.2 RTC Connector (CN3).....	11
2.4.3 Micro USB (Flash OS) (CN4).....	12
2.4.4 HDMI Connector (CN5)	12
2.4.5 COM Port Connector (RS-232 + CANBus) (CN6)	13
2.4.6 COM Port Connector (RS-232/422/485) (CN7/SW2).....	15
2.4.7 RS-232/422/485 Select (SW2)	16
2.4.8 DIO Port Connector (CN8).....	17
2.4.9 COM+DIO port Connector (CN7+CN8/SW2)	18
2.4.10 UART Debug Port Connector (CN9)	19
2.4.11 RJ-45 Connector (CN10)	19
2.4.12 M.2 2230 E-Key (CN11).....	20
2.4.13 RJ-45 Connector (CN10)	21
2.4.14 USB 3.2 Gen 2 Type-A Port (CN13).....	21
2.4.15 USB 2.0 Type-A Port (CN14).....	22
2.4.16 DC Power In Connector (CN19).....	22
2.4.17 Nano SIM Connector (CN20).....	23

2.4.18	M.2 3052 B-Key (CN21).....	24
2.5	Hardware Installation.....	25
2.5.1	Expansion Module Installation.....	25
Chapter 3	– BSP Flash Guide.....	30
3.1	Before Installation.....	31
3.2	Connecting to PC/Force Recovery Mode.....	32
3.3	Flash Image to Board.....	34
3.4	Check BSP Version.....	35
Chapter 4	– OS User Guide.....	36
4.1	Introduction.....	37
4.2	Update Note.....	38
4.3	BOXER-8651AI Power Mode.....	39

Chapter 1

Product Specifications

1.1 Specifications

System

AI Accelerator	NVIDIA® Jetson Orin™ NX
CPU	6-core Arm® Cortex® -A78AE Armv8.2 64-bit CPU
System Memory	8GB LPDDR5
Storage Device	M.2 3052 B-Key x 1 for M.2 2242 B+M-Key SSD (Default Storage) M.2 2230 E-Key x 1 (Optional)
Display Interface	HDMI 2.1 (Type-A) x 1
Ethernet	RJ-45 x 1 for GbE LAN
I/O	USB 3.2 Gen 2 (Type-A) x 2 USB 2.0 (Type-A) x 2 DB-9 for RS-232 (Rx/Tx/CTS/RTS)/485 x 1 and CANBus FD x 1 DB-15 for RS-232 (Rx/Tx)/422/485 x 1 and DIO x 8 Micro USB x 1 for OS Flash Recovery Button x 1 Antenna x 2
Expansion	M.2 3042/3052 B-Key x 1 (4G/5G/M.2 2242 B+M-Key storage) M.2 2230 E-Key x 1 (Wi-Fi/BT/Storage) SIM Slot x 1
Indicator	Power LED x 1
OS Support	Linux (NVIDIA Jetpack™ 5.0 up)

Power Supply

Power Requirement 12V~24V DC in with 2-pin Terminal Block x 1

Mechanical

Mounting Wallmount

Dimensions (W x D x H) 4.13" x 3.54" x 2.05" (105mm x 90mm x 52mm), w/o bracket

Gross Weight 2.4 lb. (1.1Kg)

Net Weight 1.58 lb. (0.7Kg)

Environmental

Operating Temperature -5°F ~ 131°F (-15°C ~ 55°C), according to IEC60068-2 with 0.5 m/s AirFlow

Storage Temperature -40°F ~ 185°F (-40°C ~ 85°C)

Storage Humidity 5% ~ 95% @ 40C, non-condensing

Anti-Vibration 3.5Grm / 5~500Hz / Operation

Anti-Shock 50G peak acceleration

Certification CE/FCC Class A

Chapter 2

Hardware Information

2.1 Dimensions

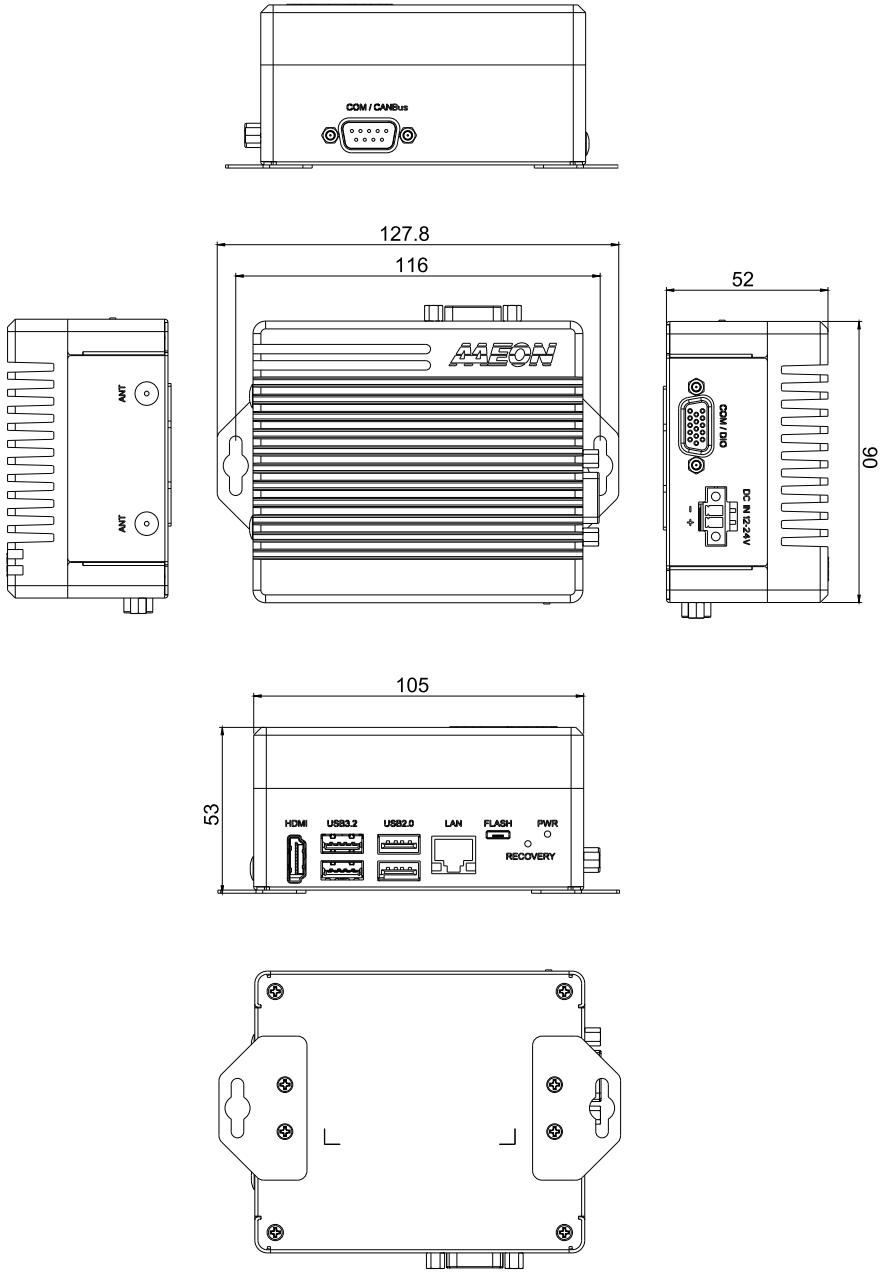

2.2 Jumpers and Connectors

Top

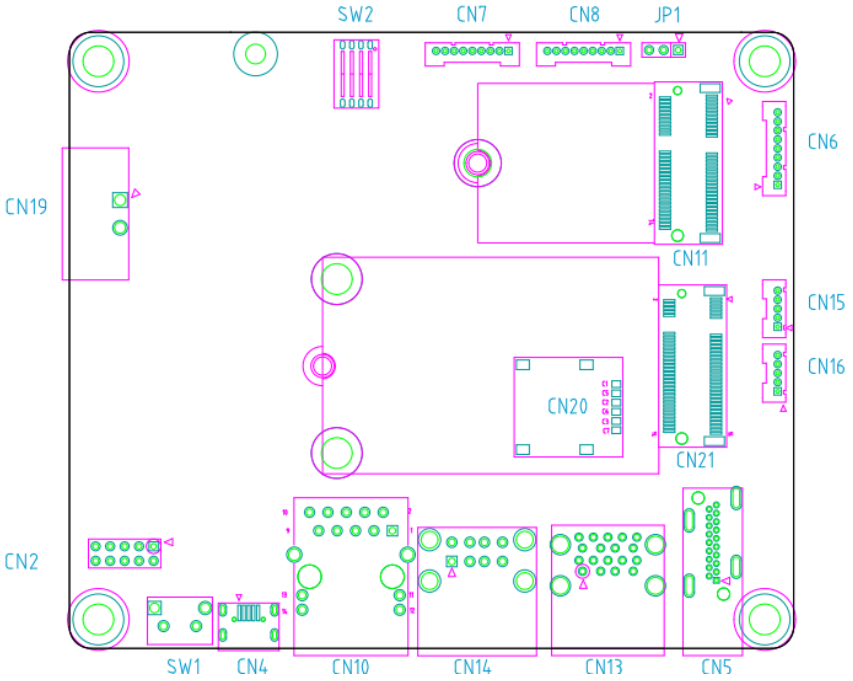

Bottom

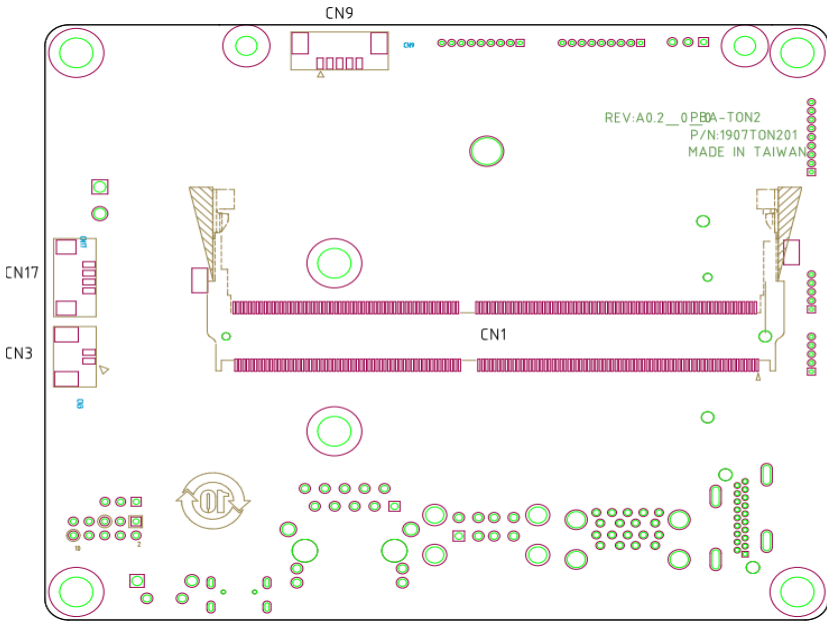

2.3 List of Jumpers

The board has a number of jumpers that allow you to configure your system to suit your application.

The table below shows the function of each of the board's jumpers

Label	Function
CN2	AT/ATX Mode Selection

2.3.1 Jumper Settings

You configure your card to match the needs of your application by setting jumpers. A jumper is the simplest kind of electric switch. It consists of two metal pins and a small metal clip (often protected by a plastic cover) that slides over the pins to connect them. To "close" a jumper you connect the pins with the clip.

To "open" a jumper you remove the clip. Sometimes a jumper will have three pins, labeled 1, 2 and 3. In this case you would connect either pins 1 and 2 or 2 and 3.

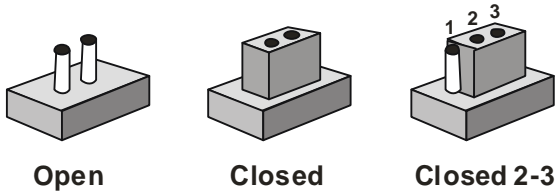

A pair of needle-nose pliers may be helpful when working with jumpers.

If you have any doubts about the best hardware configuration for your application, contact your local distributor or sales representative before you make any change.

Generally, you simply need a standard cable to make most connections.

2.3.2 AT/ATX Mode Selection (CN2)

CN2 Pin	Function
7-8	Close ATX
7-8	Open AT (Default)

2.4 List of Connectors

The board has a number of connectors that allow you to configure your system to suit your application.

The table below shows the function of each of the board's connectors

Label	Function
CN1	NVIDIA Jetson Orin NX Connector
CN2	Front Panel Connector
CN3	RTC Battery Connector
CN4	Micro USB for Flash OS
CN5	HDMI Connector
CN6	RS-232 + CANBus Connector (/dev/ttyTHS1)
CN7	RS-232/422/485 Connector (/dev/ttyTHS0)
CN8	GPIO Wafer Connector
CN9	UART Debug Wafer
CN10	RJ-45 Connector
CN11	M.2 2230 E-Key
CN13	USB 3.2 Gen 2 Type-A Port
CN14	USB 2.0 Type-A Port
CN15	USB 2.0 Wafer
CN16	USB 2.0 Wafer
CN17	FAN Wafer Connector (5V)
CN19	12~24V DC Power in Connector (3.81mm)
CN20	Nano SIM Connector
CN21	M.2 3052 B-Key
CN22	UART Debug Port
SW2	RS-232/422/485 Select

2.4.1 Front Panel Connector (CN2)

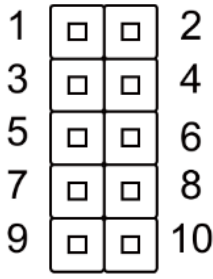

Pin	Signal	Pin	Signal
1	Button power	2	GND
3	Recovery	4	GND
5	System Reset	6	GND
7	AC OK	8	PD 10Kohm
9	3.3V AO	10	5V AO

2.4.2 RTC Connector (CN3)

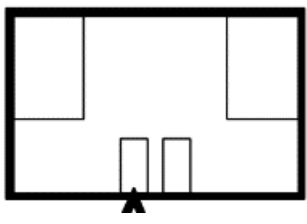

Pin	Signal	Pin	Signal
1	+3V	2	GND

2.4.3 Micro USB (Flash OS) (CN4)

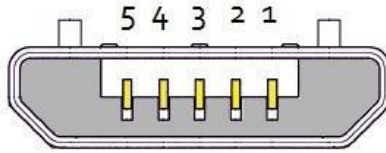

USB Micro-B

Pin	Signal	Pin	Signal
1	+5V	2	USB1-
3	USB1+	4	
5	GND		

2.4.4 HDMI Connector (CN5)

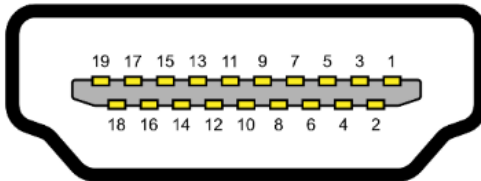

Pin	Signal	Pin	Signal
1	HDMI_DATA2_P	2	GND
3	HDMI_DATA2_N	4	HDMI_DATA1_P
5	GND	6	HDMI_DATA1_N
7	HDMI_DATA0_P	8	GND
9	HDMI_DATA0_N	10	HDMI_CLK_P
11	GND	12	HDMI_CLK_N
13	NC	14	NC
15	HDMI_SCL	16	HDMI_SDA

Pin	Signal	Pin	Signal
17	GND	18	HDMI_PWR
19	HDMI_HDP		

2.4.5 COM Port Connector (RS-232 + CANBus) (CN6)

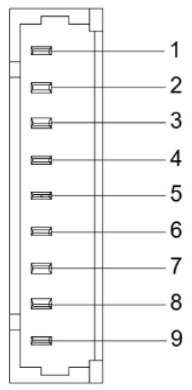

Pin	RS-232	CANBus
1		CAN0_L
2		CAN0_H
3	RXD	
4	RTS#	
5	TXD	
6	CTS#	
7		
8		
9	GND	GND

DB-9 Port (Male)

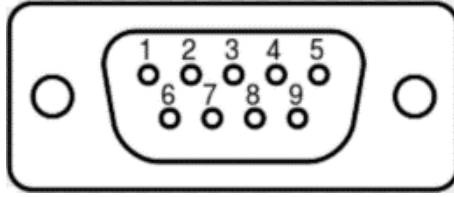

Pin	RS-232	CANBus
1		CAN0_L
2	RXD	
3	TXD	
4		
5	GND	
6		CAN0_H
7	RTS#	
8	CTS#	
9		

2.4.6 COM Port Connector (RS-232/422/485) (CN7/SW2)

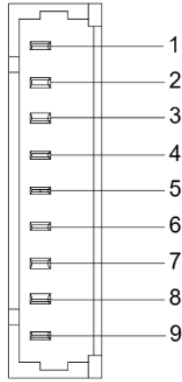

Pin	RS-232	RS-422	CANBus
1		TXD-	TXD-
2			
3	RXD	RXD+	TXD+
4			
5	TXD	TXD+	
6			
7		RXD-	
8			
9	GND	GND	GND

2.4.7 RS-232/422/485 Select (SW2)

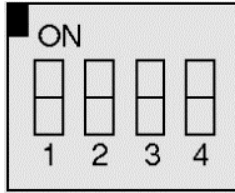

Mode	S-1	S-2	S-3	S-4
1T/1R RS-232	On	On		
1T/1R RS-422	On	Off		
1T/1R RS-485	Off	On		
Low power shutdown	Off	Off		
250kbps for RS-232 and RS-485/RS-422				On
RS-232 to 3Mbps and RS-485/RS-422 to 20Mbps				Off
Enable RS-422/RS-485 Bias and Termination Resistors.			On	
Disable RS-422/RS-485 Bias and Termination Resistors.			Off	

2.4.8 DIO Port Connector (CN8)

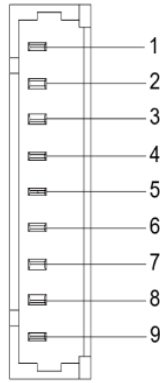

Pin	Function	DTS Name	GPIO
1	GPIO13	PH.00	391
2	I2S0 LRCK	PI.02	401
3	GPIO11	PQ.06	454
4	I2S0 SDIN	PI.01	400
5	GPIO09	PAC.06	492
6	I2S0 SDOOUT	PI.00	399
7	GPIO01	PQ.05	453
8	I2S0 SCLK	PH.07	398
9	GND		GND

Export GPIO then you can control GPIO from user space through sysfs.

For example:

```
GPIO ID:PY.02
```

```
Export PY.02
```

```
# echo PY.02 > /sys/class/gpio/export
```

```
1. Set GPIO direction to output mode
```

```
# echo "out" > /sys/class/gpio/PY.02/direction
```

```
# echo 1 > /sys/class/gpio/PY.02/value #Set output:1
```

```
# echo 0 > /sys/class/gpio/PY.02/value #Set output:0
```

```

2. Set GPIO direction to input mode
# echo "in" > /sys/class/gpio/PY.02/direction
# cat /sys/class/gpio/PY.02/value    #Read GPIO input value
Unexport PY.02
# echo PY.02 > /sys/class/gpio/unexport

```

2.4.9 COM+DIO port Connector (CN7+CN8/SW2)

DB-15 Port (Female)

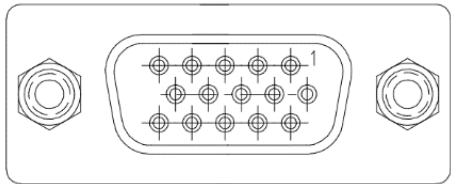

Pin	RS-232	RS-422	RS-485
1		TX-	D-
2	RXD	TX+	D+
3	TXD	RX+	
4		RX-	
5	GND		

Pin	Function	DTS Name	GPIO No.
6	GPIO13	PH.00	391
7	GPIO11	PQ.06	454
8	GPIO09	PAC.06	492
9	GPIO01	PQ.05	453
10	GND		
11	I2S0_LRCK	PI.02	401
12	I2S0_SDIN	PI.01	400
13	I2S0_SDOOUT	PI.00	399

Pin	RS-232	RS-422	RS-485
14	I2S0_SCLK	PH.07	398
15	NC		

2.4.10 UART Debug Port Connector (CN9)

Pin	Signal
1	VCC 3.3V
2	UART TX
3	UART RX
4	GND
5	GND

2.4.11 RJ-45 Connector (CN10)

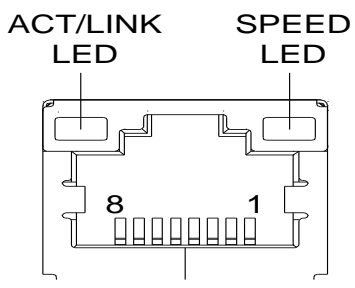

Pin	Signal	Pin	Signal
1	MDI0+	2	MDI0-
3	MDI1+	4	MDI1-
5	MDI2+	6	MDI2-
7	MDI3+	8	MDI3-

Note: Speed LED 1000Base-T Green, 10/100Base-T no LED.

2.4.12 M.2 2230 E-Key (CN11)

74	3.3V	GND	75
72	3.3V	RESERVED/REFCLKn1	73
70	UIM_POWER_SRC/GPIO1/PEWAKE1#	RESERVED/REFCLKp1	71
68	UIM_POWER_SNK/CLKREQ1#	GND	69
66	UIM_SWP/PERST1#	RESERVED/PETn1	67
64	RESERVED	RESERVED/PETp1	65
62	ALERT# (O)(0/3.3V)	GND	63
60	I2C_CLK (I)(0/3.3V)	RESERVED/PERn1	61
58	I2C_DATA (I/O)(0/3.3V)	RESERVED/PERp1	59
56	W_DISABLE1# (I)(0/3.3V)	GND	57
54	W_DISABLE2# (I)(0/3.3V)	PEWAKE0# (I/O)(0/3.3V)	55
52	PERST0# (I)(0/3.3V)	CLKREQ0# (I/O)(0/3.3V)	53
50	SUSCLK(32kHz) (I)(0/3.3V)	GND	51
48	COEX1 (I/O)(0/1.8V)	REFCLKn0	49
46	COEX2(I/O)(0/1.8V)	REFCLKp0	47
44	COEX3(I/O)(0/1.8V)	GND	45
42	VENDOR DEFINED	PETn0	43
40	VENDOR DEFINED	PETp0	41
38	VENDOR DEFINED	GND	39
36	UART CTS (I)(0/1.8V)	PERn0	37
34	UART RTS (O)(0/1.8V)	PERp0	35
32	UART RXD (I)(0/1.8V)	GND	33
	Module Key	Module Key	
	Module Key	Module Key	
	Module Key	Module Key	
	Module Key	Module Key	
22	UART TXD (O)(0/1.8V)	SDIO RESET# (I)(0/1.8V)	23
20	UART WAKE# (O)(0/3.3V)	SDIO WAKE# (O)(0/1.8V)	21
18	GND	SDIO DATA3(I/O)(0/1.8V)	19
16	LED2# (O)(OD)	SDIO DATA2(I/O)(0/1.8V)	17
14	PCM_IN/I2S SD_IN (I)(0/1.8V)	SDIO DATA1(I/O)(0/1.8V)	15
12	PCM_OUT/I2S SD_OUT (O)(0/1.8V)	SDIO DATA0(I/O)(0/1.8V)	13
10	PCM_SYNC/I2S WS (I/O)(0/1.8V)	SDIO CMD(I/O)(0/1.8V)	11
8	PCM_CLK/I2S SCK (I/O)(0/1.8V)	SDIO CLK(I)(0/1.8V)	9
6	LED1# (O)(OD)	GND	7
4	3.3V	USB_D-	5
2	3.3V	USB_D+	3
		GND	1

2.4.13 RJ-45 Connector (CN10)

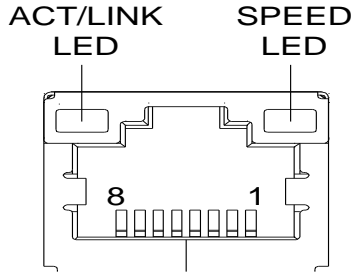

Pin	Signal	Pin	Signal
1	MDIO+	2	MDIO-

2.4.14 USB 3.2 Gen 2 Type-A Port (CN13)

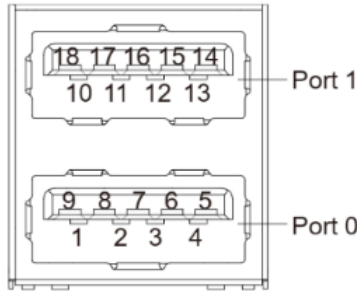

Pin	Signal	Pin	Signal
U1	VBUS_1	U10	VBUS_2
U2	(A)D-	U11	(B)D-
U3	(A)D+	U12	(B)D+
U4	GND	U13	GND
U5	(A)SSRX-	U14	(B)SSRX-
U6	(A)SSRX+	U15	(B)SSRX+

Pin	Signal	Pin	Signal
U7	GND	U16	GND
U8	(A)SSTX-	U17	(B)SSTX-
U9	(A)SSTX+	U18	(B)SSTX+

2.4.15 USB 2.0 Type-A Port (CN14)

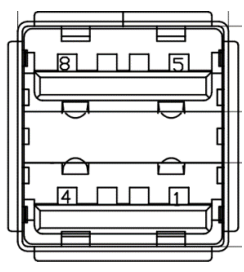

Pin	Signal	Pin	Signal
1	VBUS_1	5	VBUS_2
2	(A)D-	6	(B)D-
3	(A)D+	7	(B)D+
4	GND	8	GND

2.4.16 DC Power In Connector (CN19)

Pin	Signal	Pin	Signal
1	PWR_IN	2	GND

2.4.17 Nano SIM Connector (CN20)

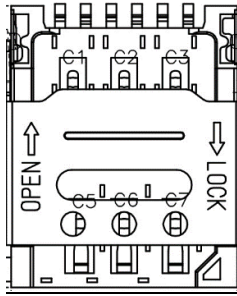

Pin	Signal
C1	VCC
C2	RST
C3	CLK
C5	GND
C6	VPP
C7	I/O

2.4.18 M.2 3052 B-Key (CN21)

74	3.3V	GND	75
72	3.3V	GND	73
70	3.3V	GND	71
68	SUSCLK(32kHz) (O)(Q/3.3V)	PEDET (NC-PCIe/GND-SATA)	69
	Connector Key	N/C	67
	Connector Key	Connector Key	
	Connector Key	Connector Key	
	Connector Key	Connector Key	
58	N/C	GND	57
56	N/C	REFCLKp	55
54	PEWAKE# (I/O)(Q/3.3V) or N/C	REFCLKn	53
52	CLKREQ# (I/O)(Q/3.3V) or N/C	GND	51
50	PERST# (O)(Q/3.3V) or N/C	PETp0/SATA-A+	49
48	N/C	PETn0/SATA-A-	47
46	N/C	GND	45
44	N/C	PERp0/SATA-B-	43
42	N/C	PERn0/SATA-B+	41
40	N/C	GND	39
38	DEVSLP (O)	PETp1	37
36	N/C	PETn1	35
34	N/C	GND	33
32	N/C	PERp1	31
30	N/C	PERn1	29
28	N/C	GND	27
26	N/C	PETp2	25
24	N/C	PETn2	23
22	N/C	GND	21
20	N/C	PERp2	19
18	3.3V	PERn2	17
16	3.3V	GND	15
14	3.3V	PETp3	13
12	3.3V	PETn3	11
10	DAS/DSS# (I/O)/LED1# (I)(O/3.3V)	GND	9
8	N/C	PERp3	7
6	N/C	PERn3	5
4	3.3V	GND	3
2	3.3V	GND	1

2.5 Hardware Installation

2.5.1 Expansion Module Installation

Before installing your expansion module, ensure the system is powered down and disconnect the power cord from the system. Make sure you have the expansion module(s) ready to install. See Chapter 1 for expansion module specifications for compatibility.

Turn the BOXER-8651AI system over so the bottom is facing up. Install each module by first inserting at an angle (approx. 30°), then gently pressing down and securing. Refer to the images below for guidance on removing the bottom panel, and overleaf for which slot corresponds with each module.

To access the interior, first remove the four (4) screws on the bottom of the chassis, as shown.

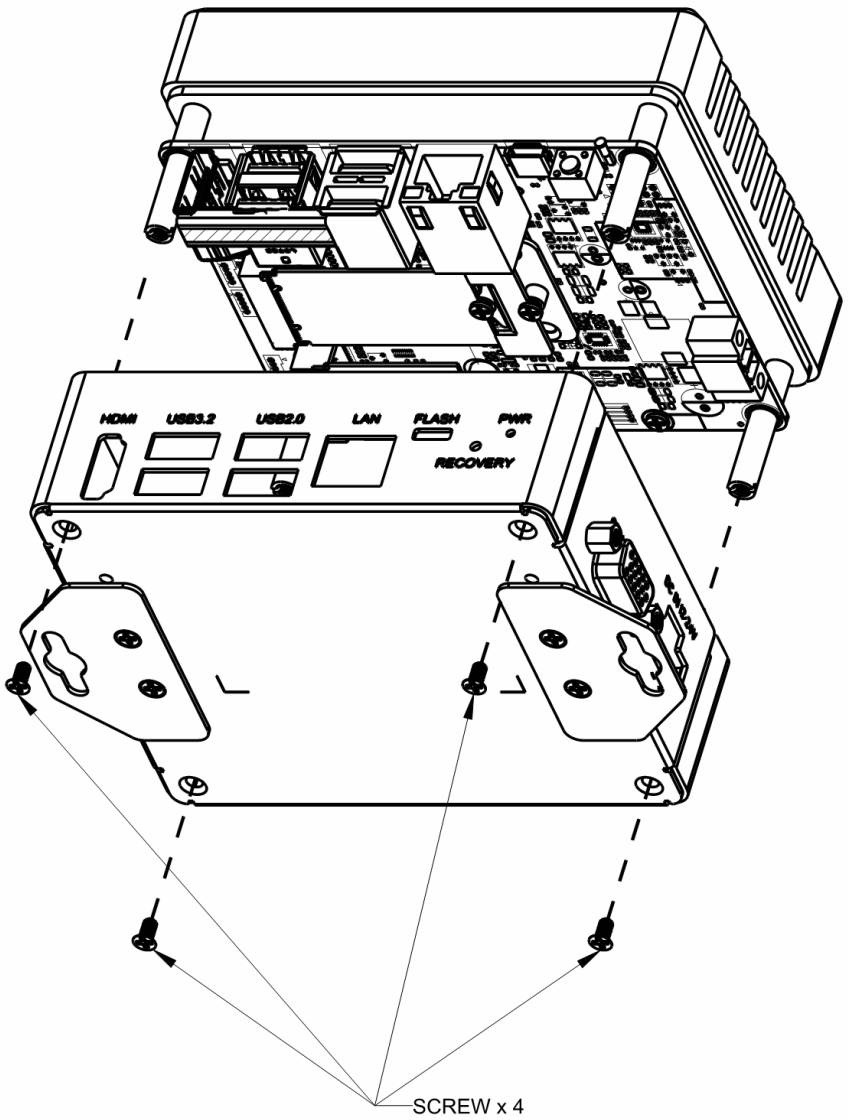

M.2 3042 B-Key (M.2 2242 B + M-Key Storage Module)

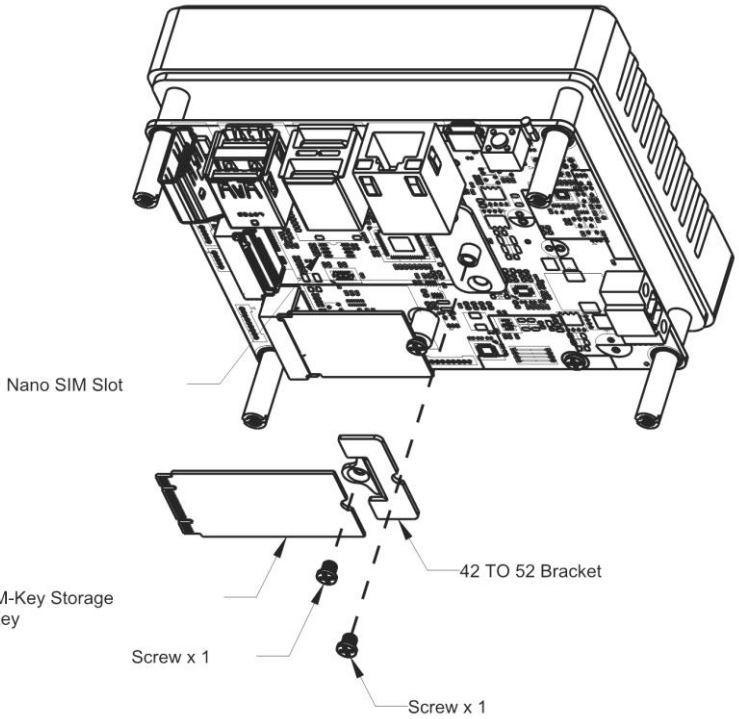

M.2 3052 B-Key

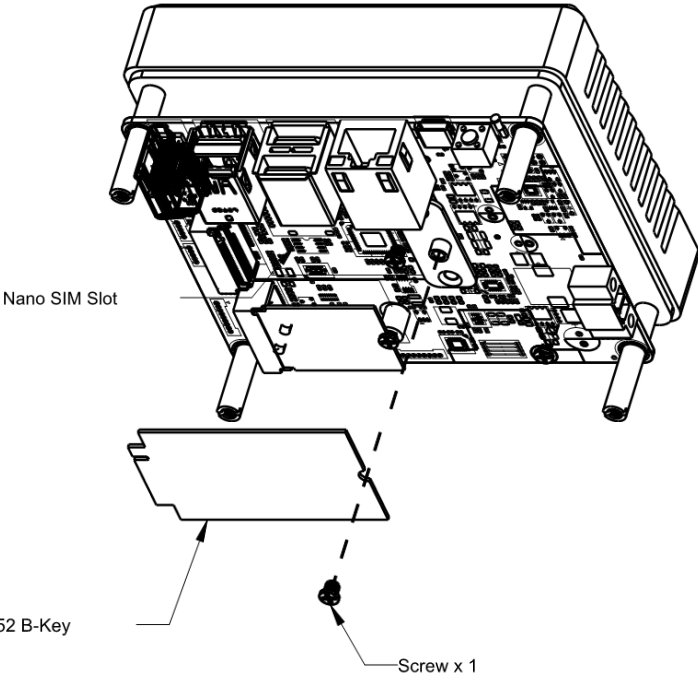

M.2 3052 B-Key

Screw x 1

M.2 2230 E-Key

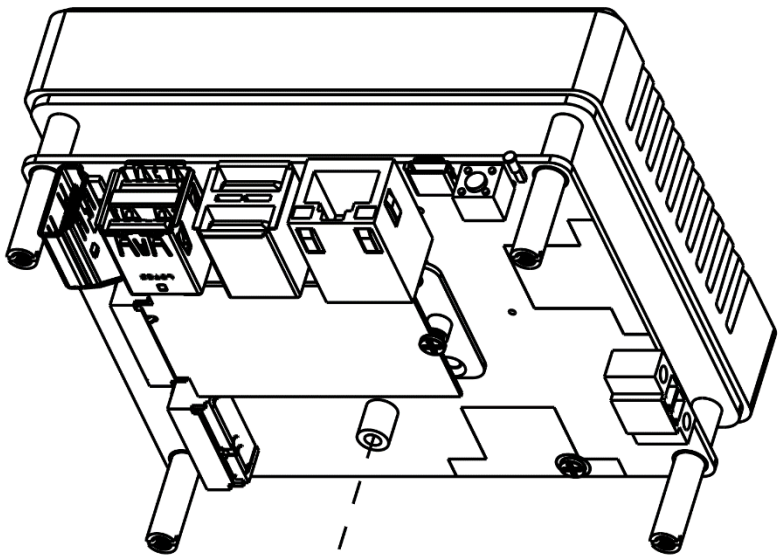

M.2 E-Key

Screw x 1

Chapter 3

BSP Flash Guide

3.1 Before Installation

Before starting the process make sure your BOXER-8651AI system is turned off and the power is disconnected. You will need a Host PC running Ubuntu 18.04, and make sure the NVIDIA® Jetson Orin™ NX module is installed onto the BOXER-8651AI carrier board system.

Note: Do not use a virtual machine as a host PC, as some virtual machines may have unstable USB connections which can cause the flash procedure to fail.

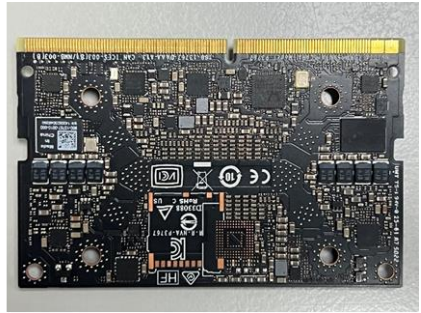

Download the compressed BSP image file:

"[BOXER_8651AI_J5.1.1_A00_1.0.2_20230822.tar.gz](#)" into the Host Ubuntu 18.04 PC directory.

Note: No spaces, special characters, or non-English characters can be used for the name of the folder where the file is stored, or its parent folder.

Ensure the language settings of Ubuntu 18.04 are set to English, and the format setting is the United States, to prevent flash failure.

3.2 Connecting to PC/Force Recovery Mode

Step 1:

On the Host computer, open Linux terminal and enter the following command to extract the compressed BSP image files (BSP file name may vary):

```
$ sudo tar -zxvf BOXER_8651AI_J5.1.1_A00_1.0.2_20230822.tar.gz
```

Note: Do not decompress the file (Internal.tar.gz) using a Windows OS, BSP should only be decompressed in a Linux EXT3/4 file system.

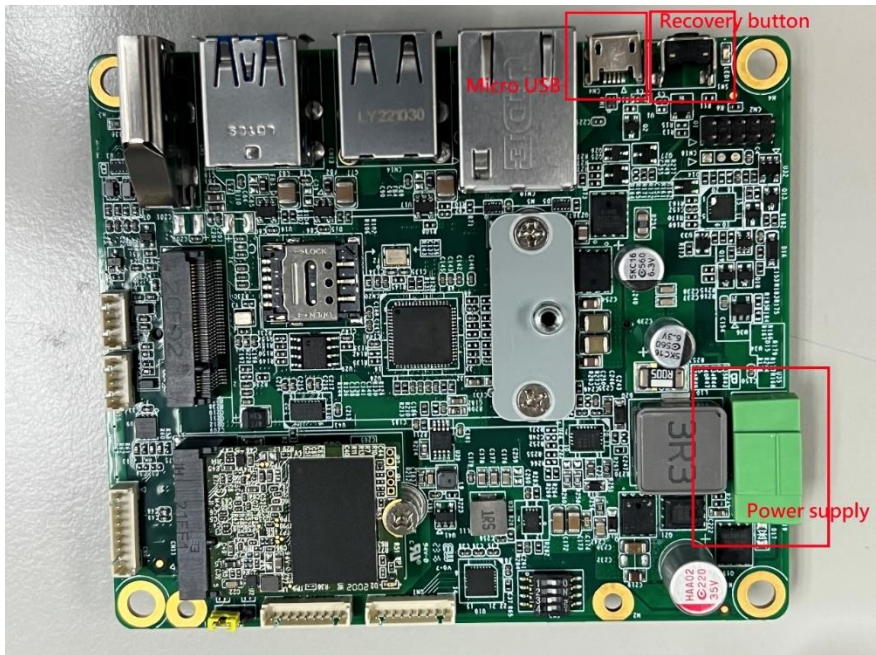

Step 2:

Perform the following actions to force the system to start in USB Recovery Mode:

1. Connect the Micro-USB plug on the USB cable to the Recovery Port on the BOXER-8651AI and the other end to an available USB port on the Host PC.
2. Connect the BOXER-8651AI power supply.

3. Press and hold the recovery key button. While holding the recovery key button, power on the system, and continue to hold the recovery key button for two seconds, then release. The BOXER-8651AI should then enter recovery mode.
4. To check if device is in recovery mode, enter the **lsusb** command in the terminal on the Host PC.

```
$ lsusb | grep "0955:7523"
```

If successful, the command will return **"0955:7523 Nvidia Corp"**

```
Bus 001 Device 018: ID 0955:7523 NVidia Corp.
```

Note: Recovery mode cannot be initiated if the NVIDIA® Jetson Orin™ NX module is disassembled. Ensure the NVIDIA® Jetson Orin™ NX module is installed and refer to the image below to perform the steps:

3.3 Flash Image to Board

Use the following steps to flash the OS to the BOXER-8651AI.

- 1) Open terminal on the Ubuntu Host PC, then access the folder you extracted in the previous section.
- 2) Enter the following command in terminal to flash the image:

```
$ ./flashboxer.sh -s 62517420 nvme
```

- 3) Wait until the image is installed. Once finished you should see the following:

```
writing item=16, 9:0:secondary_gpt, 32008902144, 16896, gpt_secondary_9_0.bin, 16896, fixed-<reserved>-0, 59012273e727e6a457084ff7805a26ed6cf1c4fa
[ 309]: l4t_flash_from_kernel: Successfully flash the external device
[ 309]: l4t_flash_from_kernel: Flashing success
[ 309]: l4t_flash_from_kernel: The device size indicated in the partition layout xnl is smaller than the actual size. This utility will try to fix the GPT.
Flash is successful
Reboot device
Cleaning up...
```

From the second time onwards, you can flash 10 images once at most, using the flash command as follows:

```
$ ./flashboxer.sh -m nvme
```

3.4 Check BSP Version

Once the flash image is successfully installed, the BOXER-8651AI will reboot automatically, then check the BSP version to see if the system is flashing the correct version of BSP.

Open a Terminal, and type command "`cat /proc/product`"

You will see the product name with version and date

```
BOXER-8651AI_J5.1.1_A00_1.0.2_20230822
```

```
{PJ_IF}_{JPV_IF}_A00_{IMGV_IF}_{BD_IF}
```

For example:

```
BOXER-8651AI_J5.1.1_A00_1.0.2_20230822
```

Note: Filename may differ from this example.

{PJ_IF} is Project Information; e.g. BOXER-8651AI

{IMGV_IF} is Build Version; e.g. 1.0.2

{JPV_IF} is Jetpack Version; e.g. J5.1.1

{BD_IF} is Build Date; e.g. 20230822

Chapter 4

OS User Guide

4.1 Introduction

The BOXER-8651AI's OS, Ubuntu/Linux version, and preinstalled SDK components are as follows:

For **Jetpack 5.1.1 (L4t 35.3.1)**

1. Ubuntu/Linux version
 - a. Ubuntu version: 20.04.6
 - b. Kernel version: 5.10.104-tegra
 - c. UEFI version: 3.1-32827747
2. Built-in all Jetson SDK Components
 - a. CUDA Toolkit for L4T 11.4.19
 - b. cuDNN 8.6.0
 - c. TensorRT 8.5.2
 - d. OpenCV 4.5.4
 - e. VPI 2.2
 - f. NVIDIA Container Runtime 1.11
 - g. Multimedia API 35.3
 - h. Nsight Systems 2023.1
 - i. Nsight Graphics 2022.6
 - j. Nsight Compute 2022.2
 - k. Compute Sanitizer 2022.2
 - l. Nsight DL Designer 2022.2
 - m. Deepstream 6.2
3. Built-in Allxon DMS
 - a. Please refer to <https://www.allxon.com/solutions>

Default login user/password is:

Account: **aaeon**

Password: **aaeon**

4.2 Update Note

Running `$ sudo apt upgrade` command in terminal will overwrite the **Aaeon kernel device tree (.dtb)/kernel image(Image)/bootloader** in OS, which can lead to unexpected results including losing I/O ports.

So Aaeon default disable Nvidia apt Repo for updating Nvidia apt package.

AAEON maintains updated versions of BSP on the product page, which follow updates to the NVIDIA Jetpack software. Contact your AAEON representative or visit the product page to download the latest version of AAEON BSP for your system:

<https://www.aaeon.com/en/>

4.3 BOXER-8651AI Power Mode

NVIDIA® Jetson Orin™ NX power mode can be selected and monitored by GUI, please refer to the following picture:

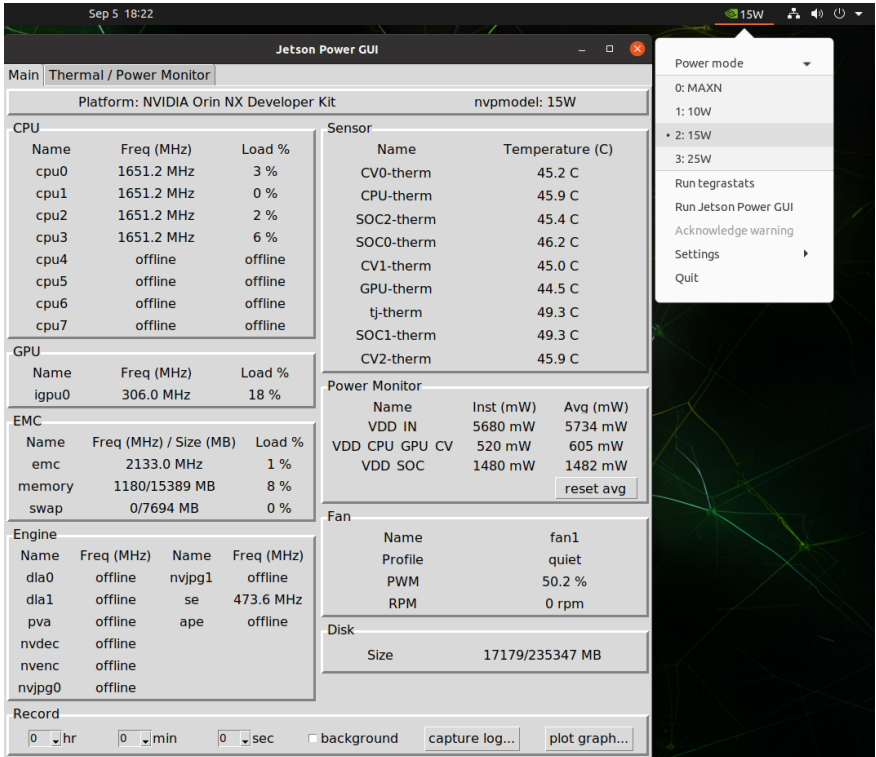

Note: Power mode is dependent on DRAM size. For more detailed information please visit <https://developer.nvidia.com/embedded/jetson-modules>