

# BOXER-8646AI

---

AI@Edge Fanless PoE Embedded AI System  
with NVIDIA<sup>®</sup> AGX Orin<sup>™</sup>

User's Manual 2<sup>nd</sup> Ed

## Copyright Notice

---

This document is copyrighted, 2024. All rights are reserved. The original manufacturer reserves the right to make improvements to the products described in this manual at any time without notice.

No part of this manual may be reproduced, copied, translated, or transmitted in any form or by any means without the prior written permission of the original manufacturer. Information provided in this manual is intended to be accurate and reliable. However, the original manufacturer assumes no responsibility for its use, or for any infringements upon the rights of third parties that may result from its use.

The material in this document is for product information only and is subject to change without notice. While reasonable efforts have been made in the preparation of this document to assure its accuracy, AAEMON assumes no liabilities resulting from errors or omissions in this document, or from the use of the information contained herein.

AAEMON reserves the right to make changes in the product design without notice to its users.

## Acknowledgements

---

All other products' name or trademarks are properties of their respective owners.

- NVIDIA®, the NVIDIA logo, Jetson™, Jetson Orin™, and JetPack™ are trademarks of the NVIDIA Corporation.
- Arm® and Arm®v8-M architecture are registered trademarks of Arm Limited.
- Linux® is the registered trademark of Linus Torvalds in the U.S. and other countries.
- Ubuntu is a registered trademark of Canonical.

All other product names or trademarks are properties of their respective owners. No ownership is implied or assumed for products, names or trademarks not herein listed by the publisher of this document.

## Packing List

---

Before setting up your product, please make sure the following items have been shipped:

Item	Quantity
● BOXER-8646AI	1
● Wallmount Bracket	2
● Screw Package	1
● Power Connector	1
● Power Adapter (Optional)	1
● Power Cord (Optional)	1

If any of these items are missing or damaged, please contact your distributor or sales representative immediately.

## About this Document

---

This User's Manual contains all the essential information, such as detailed descriptions and explanations on the product's hardware and software features (if any), its specifications, dimensions, jumper/connector settings/definitions, and driver installation instructions (if any), to facilitate users in setting up their product.

Users may refer to the product page at [AAEON.com](http://AAEON.com) for the latest version of this document.

## Safety Precautions

---

Please read the following safety instructions carefully. It is advised that you keep this manual for future references

1. All cautions and warnings on the device should be noted.
2. All cables and adapters supplied by AAEON are certified and in accordance with the material safety laws and regulations of the country of sale. Do not use any cables or adapters not supplied by AAEON to prevent system malfunction or fires.
3. Make sure the power source matches the power rating of the device.
4. Position the power cord so that people cannot step on it. Do not place anything over the power cord.
5. Always completely disconnect the power before working on the system's hardware.
6. No connections should be made when the system is powered as a sudden rush of power may damage sensitive electronic components.
7. If the device is not to be used for a long time, disconnect it from the power supply to avoid damage by transient over-voltage.
8. Always disconnect this device from any power supply before cleaning.
9. While cleaning, use a damp cloth instead of liquid or spray detergents.
10. Make sure the device is installed near a power outlet and is easily accessible.
11. Keep this device away from humidity.
12. Place the device on a solid surface during installation to prevent falls
13. Do not cover the openings on the device to ensure optimal heat dissipation.
14. Watch out for high temperatures when the system is running.
15. Do not touch the heat sink or heat spreader when the system is running
16. Never pour any liquid into the openings. This could cause fire or electric shock.

17. As most electronic components are sensitive to static electrical charge, be sure to ground yourself to prevent static charge when installing the internal components. Use a grounding wrist strap and contain all electronic components in any static-shielded containers.
18. If any of the following situations arises, please the contact our service personnel:
  - i. Damaged power cord or plug
  - ii. Liquid intrusion to the device
  - iii. Exposure to moisture
  - iv. Device is not working as expected or in a manner as described in this manual
  - v. The device is dropped or damaged
  - vi. Any obvious signs of damage displayed on the device
19. **DO NOT LEAVE THIS DEVICE IN AN UNCONTROLLED ENVIRONMENT WITH TEMPERATURES BEYOND THE DEVICE'S PERMITTED STORAGE TEMPERATURES (SEE CHAPTER 1) TO PREVENT DAMAGE.**

## FCC Statement

---

### **Warning!**



This device complies with Part 15 FCC Rules. Operation is subject to the following two conditions: (1) this device may not cause harmful interference, and (2) this device must accept any interference received including interference that may cause undesired operation.

### **Caution:**

*There is a danger of explosion if the battery is incorrectly replaced. Replace only with the same or equivalent type recommended by the manufacturer. Dispose of used batteries according to the manufacturer's instructions and your local government's recycling or disposal directives.*

### **Attention:**

*Il y a un risque d'explosion si la batterie est remplacée de façon incorrecte. Ne la remplacer qu'avec le même modèle ou équivalent recommandé par le constructeur. Recycler les batteries usées en accord avec les instructions du fabricant et les directives gouvernementales de recyclage.*



## 产品中有毒有害物质或元素名称及含量

AAEON System

QO4-381 Rev.A0

部件名称	有毒有害物质或元素					
	铅 (Pb)	汞 (Hg)	镉 (Cd)	六价铬 (Cr(VI))	多溴联苯 (PBB)	多溴二苯 醚(PBDE)
印刷电路板 及其电子组件	×	○	○	○	○	○
外部信号 连接器及线材	×	○	○	○	○	○
外壳	○	○	○	○	○	○
中央处理器 与内存	×	○	○	○	○	○
硬盘	×	○	○	○	○	○
液晶模块	×	×	○	○	○	○
光驱	×	○	○	○	○	○
触控模块	×	○	○	○	○	○
电源	×	○	○	○	○	○
电池	×	○	○	○	○	○

本表格依据 SJ/T 11364 的规定编制。

○：表示该有毒有害物质在该部件所有均质材料中的含量均在 GB/T 26572 标准规定的限量要求以下。

×：表示该有害物质的某一均质材料超出了 GB/T 26572 的限量要求，然而该部件

仍符合欧盟指令 2011/65/EU 的规范。

备注：

一、此产品所标示之环保使用期限，系指在一般正常使用状况下。

二、上述部件物质中央处理器、内存、硬盘、光驱、电源为选购品。

三、上述部件物质液晶模块、触控模块仅一体机产品适用。

**Hazardous and Toxic Materials List**

AAEON System

QO4-381 Rev.A0

Component Name	Hazardous or Toxic Materials or Elements					
	Lead (Pb)	Mercury (Hg)	Cadmium (Cd)	Hexavalent Chromium (Cr(VI))	Polybrominated biphenyls (PBBS)	Polybrominated diphenyl ethers (PBDES)
PCB and Components	X	O	O	O	O	O
Wires & Connectors for Ext.Connections	X	O	O	O	O	O
Chassis	O	O	O	O	O	O
CPU & RAM	X	O	O	O	O	O
HDD Drive	X	O	O	O	O	O
LCD Module	X	X	O	O	O	O
Optical Drive	X	O	O	O	O	O
Touch Control Module	X	O	O	O	O	O
PSU	X	O	O	O	O	O
Battery	X	O	O	O	O	O

This form is prepared in compliance with the provisions of SJ/T 11364.

O: The level of toxic or hazardous materials present in this component and its parts is below the limit specified by GB/T 26572.

X: The level of toxic of hazardous materials present in the component exceed the limits specified by GB/T 26572, but is still in compliance with EU Directive 2011/65/EU (RoHS 2).

Notes:

1. The Environment Friendly Use Period indicated by labelling on this product is applicable only to use under normal conditions.
2. Individual components including the CPU, RAM/memory, HDD, optical drive, and PSU are optional.
3. LCD Module and Touch Control Module only applies to certain products which feature these components.

# Table of Contents

---

<b>Chapter 1 - Product Specifications</b> .....	<b>1</b>
1.1 Specifications .....	2
<b>Chapter 2 – Hardware Information</b> .....	<b>4</b>
2.1 Dimensions .....	5
2.2 Jumpers and Connectors.....	6
2.3 List of Jumpers .....	8
2.3.1 Jumper Settings .....	8
2.3.2 Auto Power Button (CN20) .....	9
2.4 List of Connectors.....	10
2.4.1 RTC Battery Connector (CN1).....	12
2.4.2 HDMI Connector (CN3) .....	12
2.4.3 USB 3.2 Type A (CN16).....	13
2.4.4 DC-In Power Connector (CN25) .....	13
2.4.5 Giga Ethernet Connector (CN35) .....	14
2.4.6 10G Ethernet Connector (CN37) .....	14
2.4.7 COM 1/COM 2 Port .....	15
2.4.7.1 COM Port Connector (/dev/ttyTHS4) (CN9, UP SW2) .....	15
2.4.7.2 COM Port Connector (/dev/ttyTHS1) (CN9, Down SW1) .....	16
2.4.8 RS-232/422/485 Select (SW1, SW2) .....	17
2.4.9 UART0 Console Debug Connector (CN24) .....	17
2.4.10 Front Panel Connector (CN20) .....	18
2.4.11 PoE Ethernet Connector (CN29/CN30/CN31/CN32/CN33/CN34).....	19
2.4.12 MicroSD Connector (CN18).....	19
2.4.13 Audio Connector (CN13) .....	20
2.4.14 M.2 2230 E-Key Connector (CN7) .....	21
2.4.15 M.2 2280 M-Key Connector (CN8).....	22

2.4.16	M.2 3052 B-Key (CN6) .....	23
2.4.17	GPIO Connector (CN26).....	24
2.4.18	Micro USB (Flash OS) (CN19) .....	24
2.5	Hardware Installation .....	25
2.5.1	Expansion Module Installation.....	25
<b>Chapter 3</b>	<b>– BSP Flash Guide.....</b>	<b>28</b>
3.1	Before Installation.....	29
3.2	Connecting to PC/ Force Recovery Mode.....	30
3.3	Flash Image to Board.....	32
3.4	Check BSP Version.....	33
<b>Chapter 4</b>	<b>– OS User Guide.....</b>	<b>34</b>
4.1	Introduction .....	35
4.2	Update Note.....	36
4.3	BOXER-8646AI Power Mode.....	37
4.4	How to Release IP of PoE LAN .....	38

# Chapter 1

---

Product Specifications

## 1.1 Specifications

---

### System

<b>AI Accelerator</b>	NVIDIA® Jetson AGX Orin™
<b>CPU</b>	8-core ARM v8.2 64bit CPU, 2MB L2 + 4MB L3
<b>System Memory</b>	32GB LPDDR5
<b>Storage Device</b>	64GB eMMC 5.1 M.2 2280 M-Key x 1 (NVMe)
<b>Display Interface</b>	HDMI 2.0 (Type-A) x 1
<b>Ethernet</b>	RJ-45 x 12 for GbE PoE/PSE (802.3af/at, Max. 120W) RJ-45 x 1 for 10G LAN RJ-45 x 1 for Giga LAN
<b>I/O</b>	USB 3.2 Gen 1 (Type-A) x 2 USB 2.0 (Type-A) x 2 Micro USB x 1 for OS Flash Mic-in x 1 Line-out x 1 DB-9 x 1 for CANBus FD x 2 DB-9 x 2 for RS-232/422/485 DB-9 x 1 for DIO x 8 3-Pin Terminal Block x 1 for Power Input Power Button x 1 Recovery Button x 1 Antenna Hole x 6
<b>Expansion</b>	M.2 2230 E-Key x 1 (Wi-Fi/BT) M.2 3052 B-Key x 1 (LTE) M.2 2280 M-Key x 1 (NVMe) SIM Slot x 1

## System

Indicator	Power LED x 1
OS Support	Linux (NVIDIA Jetpack™ 5.0 or above)

## Power Supply

Power Requirement	3-Pin Terminal Block x 1 for 19V ~ 24V Input
-------------------	--

## Mechanical

Mounting	Wall Mount Kit
Dimensions (W x D x H)	10.42" x 7.24" x 3.67" (264.76mm x 184.00mm x 93.30mm)
Gross Weight	12.13 lb. (5.5Kg)
Net Weight	9.92 lb. (4.5Kg)

## Environmental

Operating Temperature	-4°F ~ 122°F (-20°C ~ 50°C with 0.5 m/s airflow)
Storage Temperature	-40°F ~ 158°F (-40°C ~ 70°C)
Storage Humidity	5 ~ 95% @ 40°C, non-condensing
Anti-Vibration	3.5Grm / 5~500Hz
Anti-Shock	50G peak acceleration
Certification	CE/FCC class A

**Note:** Actual USB, LAN and COM transmission rates are dependent on the user scenario and HW design.

# Chapter 2

---

Hardware Information



## 2.1 Dimensions

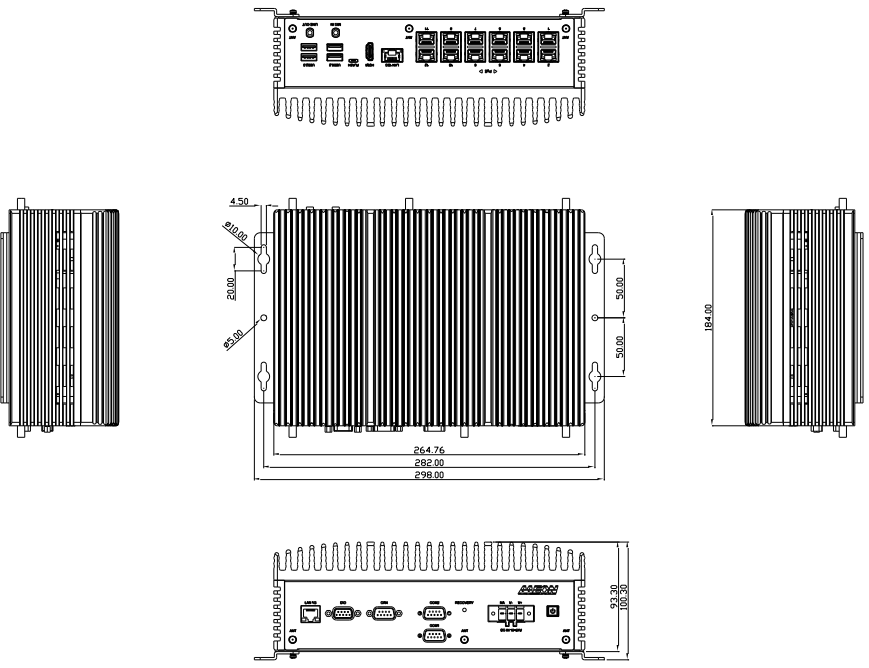

## 2.2 Jumpers and Connectors

Top

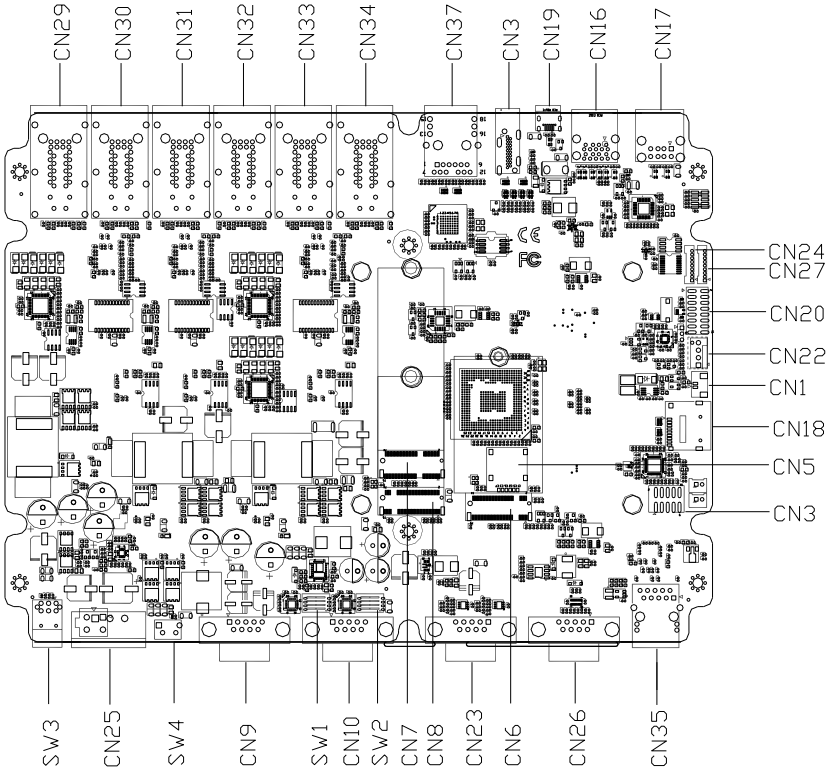

# Bottom

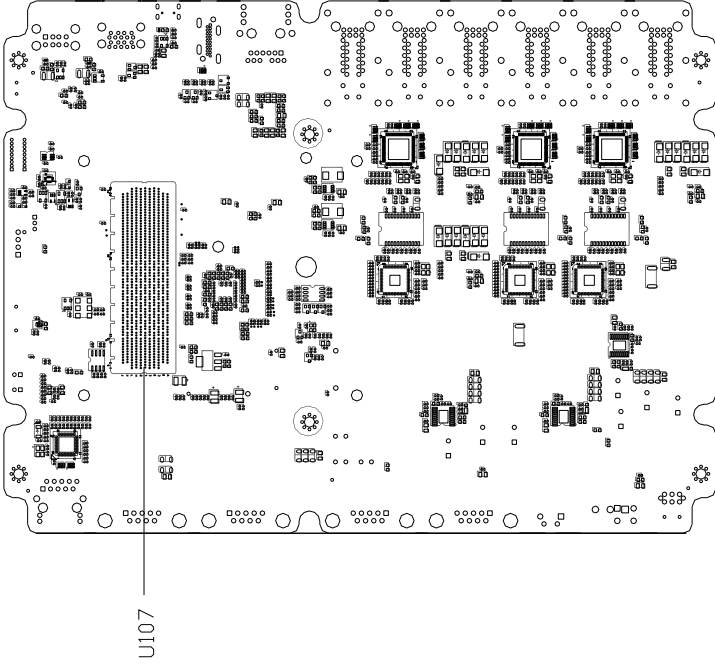

## 2.3 List of Jumpers

---

The board has a number of jumpers that allow you to configure your system to suit your application.

The table below shows the function of each of the board's jumpers

Label	Function
CN20 (5-6)	AT/ATX Mode Select

### 2.3.1 Jumper Settings

---

You configure your card to match the needs of your application by setting jumpers. A jumper is the simplest kind of electric switch. It consists of two metal pins and a small metal clip (often protected by a plastic cover) that slides over the pins to connect them. To "close" a jumper you connect the pins with the clip.

To "open" a jumper you remove the clip. Sometimes a jumper will have three pins, labeled 1, 2 and 3. In this case you would connect either pins 1 and 2 or 2 and 3.

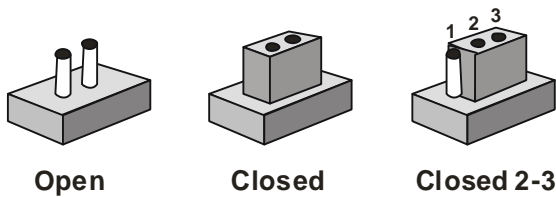

A pair of needle-nose pliers may be helpful when working with jumpers.

If you have any doubts about the best hardware configuration for your application, contact your local distributor or sales representative before you make any change.

Generally, you simply need a standard cable to make most connections.

### 2.3.2 Auto Power Button (CN20)

---

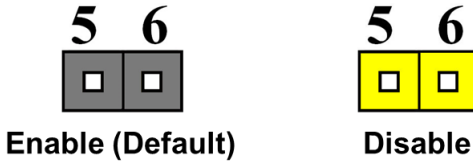

Pin	Function
5-6	Open ATX (Default)
5-6	Close AT

## 2.4 List of Connectors

---

The board has a number of connectors that allow you to configure your system to suit your application.

The table below shows the function of each of the board's connectors

Label	Function
CN1	RTC Battery Connector
CN3	HDMI Connector
CN6	M.2 3052 B-Key
CN7	M.2 2230 E-Key
CN8	M.2 2280 M-Key
CN9	COM 1/COM 2 Port
CN13	Audio Connector
CN16	USB 3.2 Type-A
CN17	USB 2.0 Type-A
CN18	Micro SD Port
CN19	Micro USB (Flash OS)
CN20	Front Panel Connector
CN22	Fan Connector
CN23	CANBus Connector
CN24	UART0 Console Debug Connector
CN25	DC-In Power Connector
CN26	GPIO Connector
CN29	Dual PoE Ethernet Connector (HUB1)
CN30	Dual PoE Ethernet Connector (HUB1)
CN31	Dual PoE Ethernet Connector (HUB2)
CN32	Dual PoE Ethernet Connector (HUB2)
CN33	Dual PoE Ethernet Connector (HUB3)
CN34	Dual PoE Ethernet Connector (HUB3)

Label	Function
CN35	Giga Ethernet Connector (PHY)
CN37	10G Ethernet Connector
SW4	Recovery Switch
SW5	Reset Switch
SW3	Power Switch
SW1	RS-232/422/485 (/dev/ttyTHS1)
SW2	RS-232/422/485 (/dev/ttyTHS4)
U107	Jetson AGX Orin Module Connector

### 2.4.1 RTC Battery Connector (CN1)

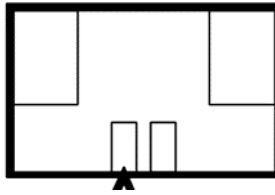

Pin	Signal	Pin	Signal
1	+3V	2	GND

### 2.4.2 HDMI Connector (CN3)

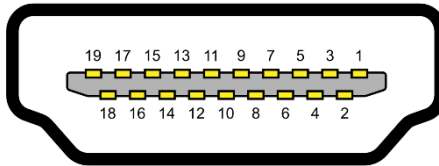

Pin	Signal	Pin	Signal
1	HDMI_DATA2_P	2	GND
3	HDMI_DATA2_N	4	HDMI_DATA1_P
5	GND	6	HDMI_DATA1_N
7	HDMI_DATA0_P	8	GND
9	HDMI_DATA0_N	10	HDMI_CLK_P
11	GND	12	HDMI_CLK_N
13	NC	14	NC
15	HDMI_SCL	16	HDMI_SDA
17	GND	18	HDMI_PWR
19	HDMI_HDP	-	-



### 2.4.3 USB 3.2 Type A (CN16)

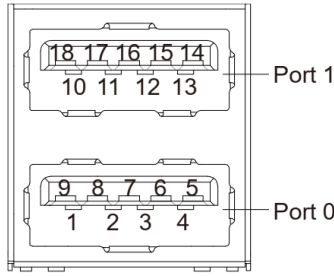

Pin	Signal	Pin	Signal
U1	VBUS_1	U10	VBUS_2
U2	(A)D-	U11	(B)D-
U3	(A)D+	U12	(B)D+
U4	GND	U13	GND
U5	(A)SSRX-	U14	(B)SSRX-
U6	(A)SSRX+	U15	(B)SSRX+
U7	GND	U16	GND
U8	(A)SSTX-	U17	(B)SSTX-
U9	(A)SSTX+	U18	(B)SSTX+

### 2.4.4 DC-In Power Connector (CN25)

Pin	Signal	Pin	Signal
1	PWR_IN	2	GND
3	NC	-	-

## 2.4.5 Giga Ethernet Connector (CN35)

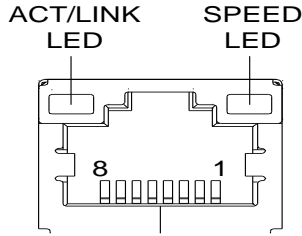

Pin	Signal	Pin	Signal
1	MDI0+	2	MDI0-
3	MDI1+	4	MDI1-
5	MDI2+	6	MDI2-
7	MDI3+	8	MDI3-

## 2.4.6 10G Ethernet Connector (CN37)

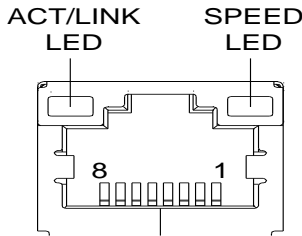

Pin	Signal	Pin	Signal
1	MDI0+	2	MDI0-
3	MDI1+	4	MDI1-
5	MDI2+	6	MDI2-
7	MDI3+	8	MDI3-

## 2.4.7 COM 1/COM 2 Port

### 2.4.7.1 COM Port Connector (/dev/ttyTHS4) (CN9, UP SW2)

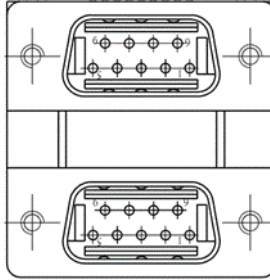

Pin	RS-232	RS-422	RS-485
1	-	TX-	D-
2	RXD	TX+	D+
3	TXD	RX+	-
4	-	RX-	-
5	GND	-	-
6	-	-	-
7	-	-	-
8	-	-	-
9	-	-	-

### 2.4.7.2 COM Port Connector (/dev/ttyTHS1) (CN9, Down SW1)

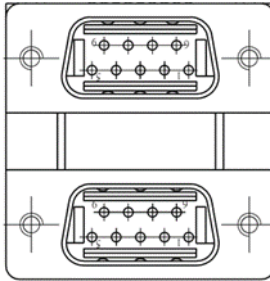

Pin	RS-232	RS-422	RS-485
1	-	TX-	D-
2	RXD	TX+	D+
3	TXD	RX+	-
4	-	RX-	-
5	GND	-	-
6	-	-	-
7	-	-	-
8	-	-	-
9	-	-	-

## 2.4.8 RS-232/422/485 Select (SW1, SW2)

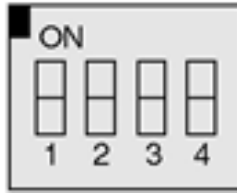

Mode	S-1	S-2	S-3	S-4
1T/1R RS-232	On	On	-	-
1T/1R RS-422	On	Off	-	-
1T/1R RS-485	Off	On	-	-
Low power shutdown	Off	Off	-	-
250kbps for RS-232 and RS-485/RS-422	-	-	-	On
RS-232 to 3Mbps and RS-485/RS-422 to 20Mbps	-	-	-	Off
Enable RS-422/RS-485 bias and termination resistors.	-	-	On	-
Disable RS-422/RS-485 bias and termination resistors.	-	-	Off	-

## 2.4.9 UART0 Console Debug Connector (CN24)

Pin	Signal
1	VCC 3.3V
2	UART RX
3	GND
4	UART TX
5	GND

## 2.4.10 Front Panel Connector (CN20)

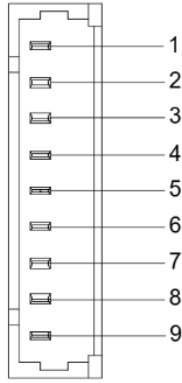

Pin	Signal	Pin	Signal
1	Carrier board standby	2	GND
3	Button power	4	CVM_PRSENT1
5	System Overcurrent Indicator	6	GND
7	LED Green	8	LED_Blue
9	LED Power (105ohm Pu)	10	-

### 2.4.11 PoE Ethernet Connector (CN29/CN30/CN31/CN32/CN33/CN34)

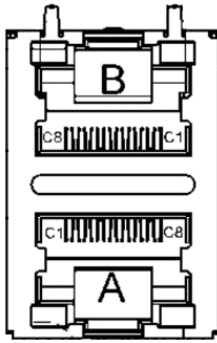

Pin	Signal	Pin	Signal
1	MDI0+	2	MDI0-
3	MDI1+	4	MDI1-
5	MDI2+	6	MDI2-
7	MDI3+	8	MDI3-

### 2.4.12 MicroSD Connector (CN18)

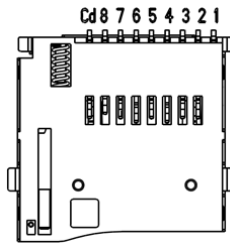

USB Card Pin Map

Pin (Card)	Pin (Connector)	Function
1	#1	DAT2
2	#2	CD/DAT3

## USB Card Pin Map

Pin (Card)	Pin (Connector)	Function
3	#3	CMD
4	#4	VDD
5	#5	CLK
6	#6	VSS
7	#7	DAT0
8	#8	DAT1

## 2.4.13 Audio Connector (CN13)

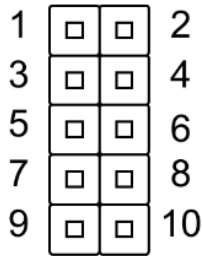

Pin	Signal	Pin	Signal
1	MIC1	2	GND
3	MIC2	4	GPIO4
5	HPO_R	6	MIC_IN_DET
7	GND	8	-
9	HPO_L	10	GPIO3

GPIO3: Headphone or jack detection

GPIO4: Presence – detects if audio dongle is connected to header.



## 2.4.14 M.2 2230 E-Key Connector (CN7)

		GND	75
74	3.3V	RESERVED/REFCLKn1	73
72	3.3V	RESERVED/REFCLKp1	71
70	UIM_POWER_SRC/GPIO1/PEWAKE1#	GND	69
68	UIM_POWER_SNK/CLKREQ1#	RESERVED/PETn1	67
66	UIM_SWP/PERST1#	RESERVED/PETp1	65
64	RESERVED	GND	63
62	ALERT# (O)(0/3.3V)	RESERVED/PERn1	61
60	I2C_CLK (I)(0/3.3V)	RESERVED/PERp1	59
58	I2C_DATA (I/O)(0/3.3V)	GND	57
56	W_DISABLE1# (I)(0/3.3V)	PEWAKE0# (I/O)(0/3.3V)	55
54	W_DISABLE2# (I)(0/3.3V)	CLKREQ0# (I/O)(0/3.3V)	53
52	PERST0# (I)(0/3.3V)	GND	51
50	SUSCLK(32kHz) (I)(0/3.3V)	REFCLKn0	49
48	COEX1 (I/O)(0/1.8V)	REFCLKp0	47
46	COEX2(I/O)(0/1.8V)	GND	45
44	COEX3(I/O)(0/1.8V)	PETn0	43
42	VENDOR DEFINED	PETp0	41
40	VENDOR DEFINED	GND	39
38	VENDOR DEFINED	PERn0	37
36	UART CTS (I)(0/1.8V)	PERp0	35
34	UART RTS (O)(0/1.8V)	GND	33
32	UART RXD (I)(0/1.8V)	Module Key	
	Module Key	Module Key	
	Module Key	Module Key	
	Module Key	Module Key	
	Module Key	Module Key	
22	UART TXD (O)(0/1.8V)	SDIO RESET# (I)(0/1.8V)	23
20	UART WAKE# (O)(0/3.3V)	SDIO WAKE# (O)(0/1.8V)	21
18	GND	SDIO DATA3(I/O)(0/1.8V)	19
16	LED2# (O)(OD)	SDIO DATA2(I/O)(0/1.8V)	17
14	PCM_IN/I2S SD_IN (I)(0/1.8V)	SDIO DATA1(I/O)(0/1.8V)	15
12	PCM_OUT/I2S SD_OUT (O)(0/1.8V)	SDIO DATA0(I/O)(0/1.8V)	13
10	PCM_SYNC/I2S WS (I/O)(0/1.8V)	SDIO CMD(I/O)(0/1.8V)	11
8	PCM_CLK/I2S SCK (I/O)(0/1.8V)	SDIO CLK(I)(0/1.8V)	9
6	LED1# (O)(OD)	GND	7
4	3.3V	USB_D-	5
2	3.3V	USB_D+	3
		GND	1

## 2.4.15 M.2 2280 M-Key Connector (CN8)

74	3.3V	GND	75
72	3.3V	GND	73
70	3.3V	GND	71
68	SUSCLK(32kHz) (O)(0/3.3V)	PEDET (NC-PCIe/GND-SATA)	69
	Connector Key	N/C	67
	Connector Key	Connector Key	
	Connector Key	Connector Key	
	Connector Key	Connector Key	
	Connector Key	Connector Key	
58	N/C	GND	57
56	N/C	REFCLKp	55
54	PEWAKE# (I/O)(0/3.3V) or N/C	REFCLKn	53
52	CLKREQ# (I/O)(0/3.3V) or N/C	GND	51
50	PERST# (O)(0/3.3V) or N/C	PETp0/SATA-A+	49
48	N/C	PETn0/SATA-A-	47
46	N/C	GND	45
44	N/C	PERp0/SATA-B-	43
42	N/C	PERn0/SATA-B+	41
40	N/C	GND	39
38	DEVSFP (O)	PETp1	37
36	N/C	PETn1	35
34	N/C	GND	33
32	N/C	PERp1	31
30	N/C	PERn1	29
28	N/C	GND	27
26	N/C	PETp2	25
24	N/C	PETn2	23
22	N/C	GND	21
20	N/C	PERp2	19
18	3.3V	PERn2	17
16	3.3V	GND	15
14	3.3V	PETp3	13
12	3.3V	PETn3	11
10	DAS/DSS# (I/O)/LED1# (I)(0/3.3V)	GND	9
8	N/C	PERp3	7
6	N/C	PERn3	5
4	3.3V	GND	3
2	3.3V	GND	1

## 2.4.16 M.2 3052 B-Key (CN6)

74	1.8V	GND	75
72	1.8V	RESERVED/REFCLKN1	73
70	UIM_Power_In/GPIO1/PEWake1#	RESERVED/REFCLKP1	71
68	UIM_Power_Out/CLKREQ1#	GND	69
66	UIM_SWP/PERST1#	Reserved/PERn1	67
64	RESERVED	Reserved/PERp1	65
62	ALERTW (I)(0/3.3)	GND	63
60	I2C CLK (O)(0/3.3)	Reserved/PETn1	61
58	I2C DATA (IO)(0/3.3)	Reserved/PETp1	59
56	W_DISABLE#1 (O)(0/3.3V)	GND	57
54	Reserved/W_DISABLE#2 (O)(0/3.3V)	PEWake0# (IO)(0/3.3V)	55
52	PERST0# (O)(0/3.3V)	CLKREQ0# (IO)(0/3.3V)	53
50	SUSCLK(32kHz) (O)(0/3.3V)	GND	51
48	COEX1(I/O)(0/1.8V)	REFCLKNO	49
46	COEX2(I/O)(0/1.8V)	REFCLKPO	47
44	COEX3(I/O)(0/1.8V)	GND	45
42	VENDOR DEFINED	PERn0	43
40	VENDOR DEFINED	PERp0	41
38	VENDOR DEFINED	GND	39
36	UART RTS (O)(0/1.8V)	PETn0	37
34	UART CTS (I)(0/1.8V)	PETp0	35
32	UART Tx (O)(0/1.8V)	GND	33
	Connector Key	Connector Key	
	Connector Key	Connector Key	
	Connector Key	Connector Key	
	Connector Key	Connector Key	
22	UART Rx (I)(0/1.8V)	SDIO Reset(O)(0/1.8V)	23
20	UART Wake (I)(0/3.3V)	SDIO Wake(I)(0/1.8V)	21
18	GND	SDIO DAT3(IO)(0/1.8V)	19
16	LED#2 (I)(OD)	SDIO DAT2(IO)(0/1.8V)	17
14	PCM_OUT/I2S SD_OUT (O)(0/1.8V)	SDIO DAT1(IO)(0/1.8V)	15
12	PCM_IN/I2S SD_IN (I)(0/1.8V)	SDIO DAT0(IO)(0/1.8V)	13
10	PCM_SYNC/I2S WS (OI)(0/1.8V)	SDIO CMD(IO)(0/1.8V)	11
8	PCM_CLK/I2S SCK (OI)(0/1.8V)	SDIO CLK(O)(0/1.8V)	9
6	LED#1 (I)(OD)	GND	7
4	1.8V	USB_D-	5
2	1.8V	USB_D+	3
		GND	1

### 2.4.17 GPIO Connector (CN26)

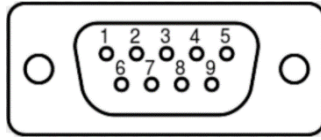

Pin	Function	Voltage Level
1	GPIO493	3.3V-
2	GPIO491	3.3V-
3	GPIO495	3.3V-
4	GPIO393	3.3V-
5	GND	3.3V-
6	GPIO492	3.3V-
7	GPIO494	3.3V-
8	GPIO422	3.3V-
9	GPIO344	GND

### 2.4.18 Micro USB (Flash OS) (CN19)

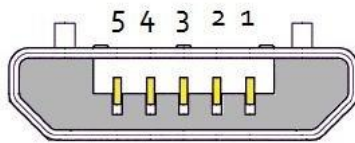

USB Micro-B

Pin	Signal	Pin	Signal
1	+5V	2	USB1-
3	USB1+	4	-
5	GND	-	-

## 2.5 Hardware Installation

### 2.5.1 Expansion Module Installation

Before installing your expansion module, ensure the system is powered down and disconnect the power cord from the system. Make sure you have the expansion module ready to install. See Chapter 1 for expansion module specifications for compatibility.

Turn the BOXER-8646AI system over so the bottom is facing up. Install each module by first inserting at an angle (approx 30°), then gently pressing down and securing. Refer to the images below for guidance on removing the bottom panel, and overleaf for which slot corresponds with M.2 2280, M.2 3052 and M.2 2230 modules.

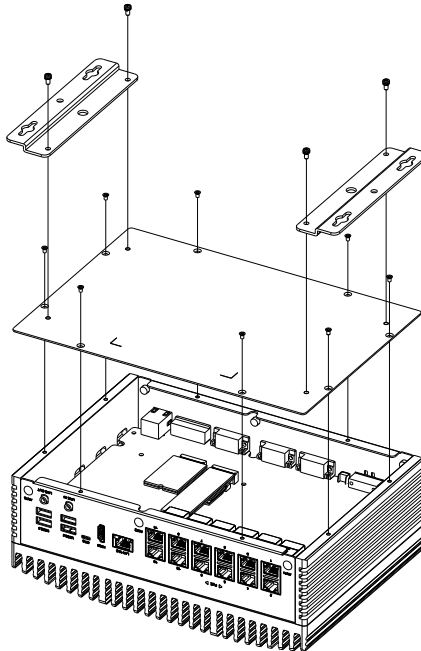

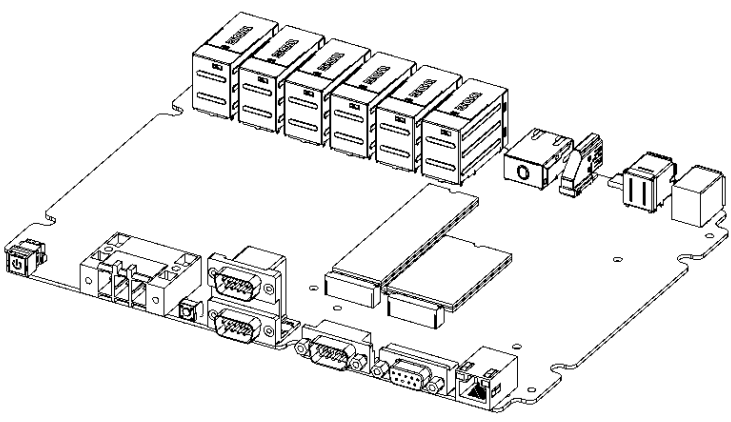
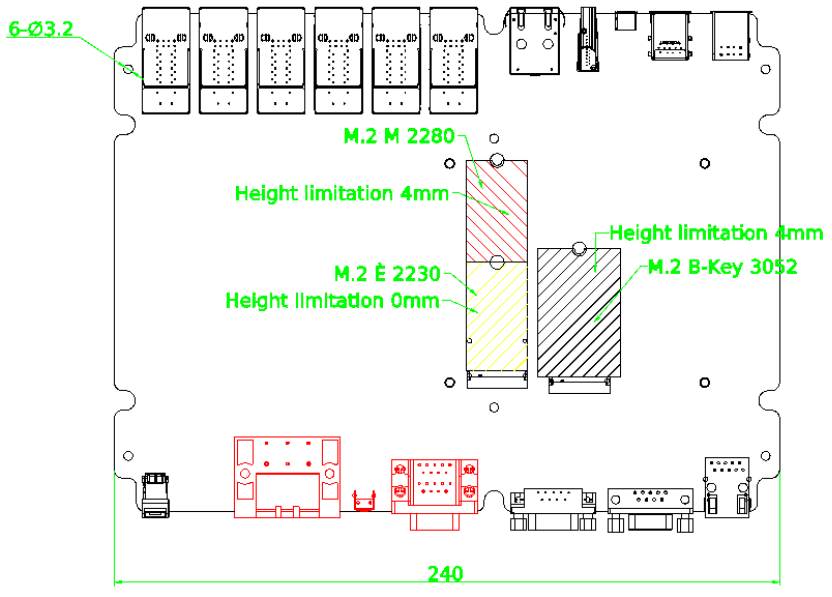

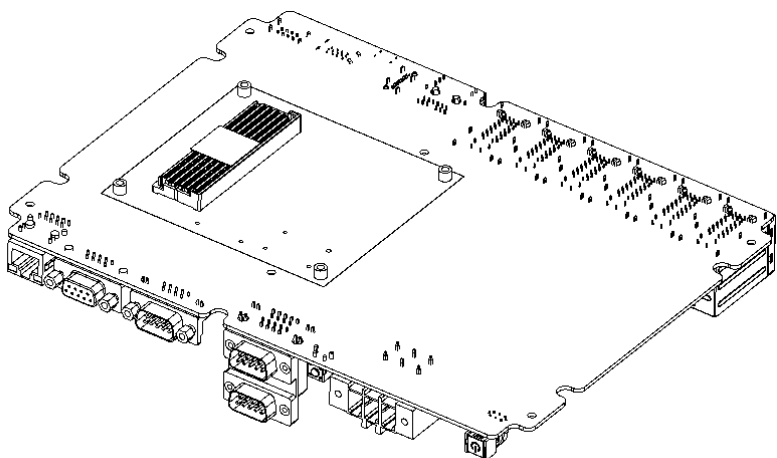
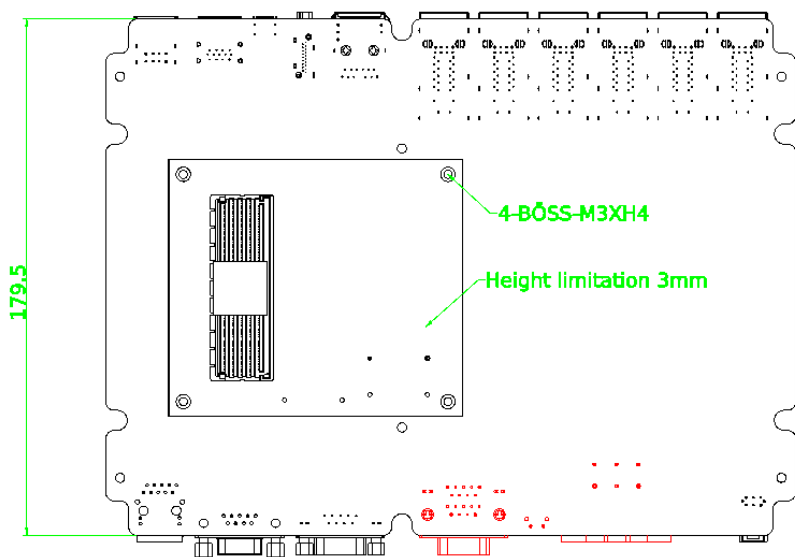

# Chapter 3

---

BSP Flash Guide



### 3.1 Before Installation

---

Before starting the process make sure your BOXER-8646AI system is turned off and the power is disconnected. You will need a Host PC running Ubuntu 18.04, and make sure the NVIDIA Jetson Orin AGX module is installed onto the BOXER-8646AI carrier board system.

**Note:** Do not use a virtual machine as a host PC, as some virtual machines may have unstable USB connections which can cause the flash procedure to fail.



Download the compressed BSP image file “**Internal.tar.gz**” into the Host Ubuntu 18.04 PC directory.

**Note:** No spaces, special characters, or non-English characters can be used for the name of the folder where the file is stored, or its parent folder.

Ensure the language settings of Ubuntu 18.04 are set to English, and the format setting is the United States, to prevent flash failure.

## 3.2 Connecting to PC/ Force Recovery Mode

---

### Step 1:

On the Host computer, open Linux terminal and enter the following command to extract the compressed BSP image files (BSP file name may vary):

```
$ sudo tar -zxvf Internal.tar.gz
```

**Note:** Do not decompress the file (Internal.tar.gz) using a Windows OS, BSP should only be decompressed in a Linux EXT3/4 file system.

### Step 2:

Perform the following actions to force the system to start in USB Recovery Mode:

1. Connect the Micro-USB plug on the USB cable to the Recovery Port on the BOXER-8646AI, and the other end to an available USB port on the Host PC.
2. Connect the BOXER-8646AI to a power supply.
3. Press and hold the recovery key button. While holding the recovery key button, power on the system, and continue to hold the recovery key button for two seconds, then release. The BOXER-8646AI should then enter recovery mode.
4. To check if device is in recovery mode, enter the command `lsusb` in terminal on Host.

```
$ lsusb | grep "0955:7223"
```

If successful, the command will return "0955:7223 Nvidia Corp"

```
Bus 001 Device 003: ID 0955:7223 NVidia Corp.
```

**Note:** Recovery mode cannot be initiated if the NVIDIA Jetson Orin AGX module is disassembled. Ensure the NVIDIA Jetson Orin AGX module is installed and refer to the image below to perform the steps:

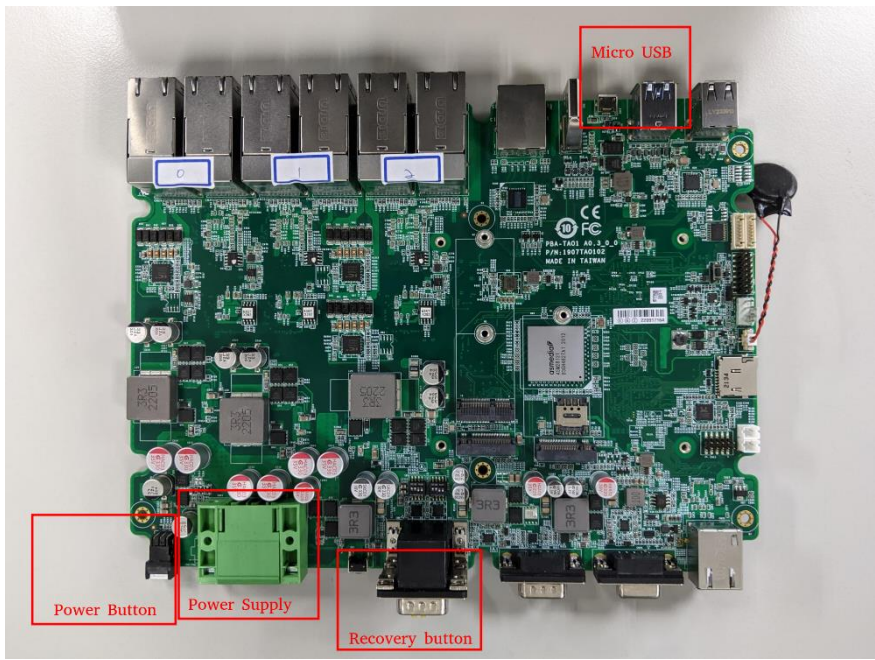

### 3.3 Flash Image to Board

---

Use the following steps to flash the OS to the BOXER-8646

AI.

- 1) Open terminal on the Ubuntu Host PC, then access the folder you extracted in the previous section.
- 2) Enter the following command in terminal to flash the image:  
**\$ sudo ./flashboxer.sh**
- 3) Wait as the image is installed. Once complete you should see the following:

```
[ 883.0285 ] Flashing completed
[ 883.0287 ] Coldbooting the device
[ 883.0328 ] tegrarcM_v2 --chip 0x23 --ismb2
[ 883.0363 ] MB2 version 01.00.0000
[ 883.1397 ]
[ 883.1399 ] Coldbooting the device
[ 883.1443 ] tegrarcM_v2 --chip 0x23 --reboot coldboot
[ 883.1479 ] MB2 version 01.00.0000
[ 883.2727 ]
*** The target t186ref has been flashed successfully. ***
Reset the board to boot from internal eMMC.
```

### 3.4 Check BSP Version

---

Once the flash image is successfully installed, the BOXER-8646AI will reboot automatically, then check the BSP version to see if the system is flashing the correct version of BSP.

Open a Terminal, and type command “`cat /proc/product`”

```
aaeon@linux:~$ cat /proc/product
BOXER-8646AI_J5.0.2_E00_1.0.1_20221123
BOXER-8646AI.Ubuntu20.04_AGXORINJP5.0.2_V1.0.1_23/11/2022
```

The version name will follow the format of:

`{PJ_IF}.` `{OS_IF}``_{PLF_IF}``{JPV_IF}``_{IMGV_IF}``_{BD_IF}`

For example:

**BOXER-8646AI.Ubuntu20.04\_AGXORINJP5.0.2\_V1.0.1\_23/11/2022**

Note: Filename may differ from this example.

`{OS_IF}` is OS Information; e.g. Ubuntu20.04

`{PLF_IF}` is Platform Information; e.g. AGXORIN

`{PJ_IF}` is Project Information; e.g. BOXER-8646AI

`{IMGV_IF}` is Build Number; e.g. v1.0.0

`{JPV_IF}` is Jetpack Version; e.g. jp5.0.2

`{BD_IF}` is Build Date; e.g. 17/08/2022

# Chapter 4

---

OS User Guide

## 4.1 Introduction

---

The BOXER-8646AI's OS, Ubuntu/Linux version, and preinstalled SDK components are as follows:

For **Jetpack 5.0.2 (L4t 35.1)**

1. Ubuntu/Linux version
  - a. Ubuntu version: 20.04.4
  - b. Kernel version: 5.10.104-tegra
  - c. UEFI version: EFI v2.70 by EDK II
2. Built-in all Jetson SDK Components
  - a. CUDA Toolkit for L4T 11.4
  - b. cuDNN 8.4
  - c. TensorRT 8.4
  - d. OpenCV 4.5
  - e. VPI 2.1
  - f. NVIDIA Container Runtime 1.10
  - g. Multimedia API 35.1
  - h. Nsight Systems 2022.3
  - i. Nsight Graphics 2022.3
  - j. Nsight Compute 2022.2
  - k. Compute Sanitizer 2022.2
  - l. Nsight DL Designer 2022.1
  - m. Deepstream 6.1.1
3. Built-in Allxon DMS
  - a. Please refer to vendor website at <https://www.allxon.com/solutions>

Default login user/password is:

Account: **aaeon**

Password: **aaeon**

## 4.2 Update Note

---

Running `$ sudo apt upgrade` command in terminal will overwrite the **Aaeon kernel device tree(.dtb)/kernel image(Image)/bootloader** in the OS, which can lead to unexpected results, including the loss of I/O ports.

So Aaeon default disable Nvidia apt Repo for updating Nvidia apt package.

AAEON maintains updated versions of BSP on the product page, which follow updates to the NVIDIA Jetpack software. Contact your AAEON representative or visit the product page to download the latest version of Aaeon BSP for your system:

<https://www.aaeon.com/en/>



### 4.3 BOXER-8646AI Power Mode

NVIDIA Jetson Orin AGX power mode can be selected and monitored by GUI, please refer to the following picture:



## 4.4 How to Release IP of PoE LAN

---

When unplugging the network cable of PoE LAN, the IP will not be released, please enter the following command to release the IP:

```
$ sudo ifconfig <interface> down && sleep 5 && sudo ifconfig <interface> up
```

Replace `<interface>` with the name of the network interface you want to release the IP address for, such as `eth0` or `wlan0`.