

BOXER-8641AI

AI@Edge Compact Fanless Embedded
AI System with NVIDIA[®] AGX Orin[™]

User's Manual 2nd Ed

Copyright Notice

This document is copyrighted, 2024. All rights are reserved. The original manufacturer reserves the right to make improvements to the products described in this manual at any time without notice.

No part of this manual may be reproduced, copied, translated, or transmitted in any form or by any means without the prior written permission of the original manufacturer. Information provided in this manual is intended to be accurate and reliable. However, the original manufacturer assumes no responsibility for its use, or for any infringements upon the rights of third parties that may result from its use.

The material in this document is for product information only and is subject to change without notice. While reasonable efforts have been made in the preparation of this document to assure its accuracy, AAEMON assumes no liabilities resulting from errors or omissions in this document, or from the use of the information contained herein.

AAEMON reserves the right to make changes in the product design without notice to its users.

Acknowledgements

All other products' name or trademarks are properties of their respective owners.

- NVIDIA®, the NVIDIA logo, Jetson™, Jetson Orin™, and JetPack™ are trademarks of the NVIDIA Corporation.
- Arm® and Arm®v8-M architecture are registered trademarks of Arm Limited.
- Linux® is the registered trademark of Linus Torvalds in the U.S. and other countries.
- Ubuntu is a registered trademark of Canonical.

All other product names or trademarks are properties of their respective owners. No ownership is implied or assumed for products, names or trademarks not herein listed by the publisher of this document.

Packing List

Before setting up your product, please make sure the following items have been shipped:

Item	Quantity
● BOXER-8641AI	1
● Wallmount Bracket	2
● Screw Package	1
● Power Adapter	Optional

If any of these items are missing or damaged, please contact your distributor or sales representative immediately.

About this Document

This User's Manual contains all the essential information, such as detailed descriptions and explanations on the product's hardware and software features (if any), its specifications, dimensions, jumper/connector settings/definitions, and driver installation instructions (if any), to facilitate users in setting up their product.

Users may refer to the product page at AAEON.com for the latest version of this document.

Safety Precautions

Please read the following safety instructions carefully. It is advised that you keep this manual for future references

1. All cautions and warnings on the device should be noted.
2. All cables and adapters supplied by AAEON are certified and in accordance with the material safety laws and regulations of the country of sale. Do not use any cables or adapters not supplied by AAEON to prevent system malfunction or fires.
3. Make sure the power source matches the power rating of the device.
4. Position the power cord so that people cannot step on it. Do not place anything over the power cord.
5. Always completely disconnect the power before working on the system's hardware.
6. No connections should be made when the system is powered as a sudden rush of power may damage sensitive electronic components.
7. If the device is not to be used for a long time, disconnect it from the power supply to avoid damage by transient over-voltage.
8. Always disconnect this device from any power supply before cleaning.
9. While cleaning, use a damp cloth instead of liquid or spray detergents.
10. Make sure the device is installed near a power outlet and is easily accessible.
11. Keep this device away from humidity.
12. Place the device on a solid surface during installation to prevent falls
13. Do not cover the openings on the device to ensure optimal heat dissipation.
14. Watch out for high temperatures when the system is running.
15. Do not touch the heat sink or heat spreader when the system is running
16. Never pour any liquid into the openings. This could cause fire or electric shock.

17. As most electronic components are sensitive to static electrical charge, be sure to ground yourself to prevent static charge when installing the internal components. Use a grounding wrist strap and contain all electronic components in any static-shielded containers.
18. If any of the following situations arises, please the contact our service personnel:
 - i. Damaged power cord or plug
 - ii. Liquid intrusion to the device
 - iii. Exposure to moisture
 - iv. Device is not working as expected or in a manner as described in this manual
 - v. The device is dropped or damaged
 - vi. Any obvious signs of damage displayed on the device
19. **DO NOT LEAVE THIS DEVICE IN AN UNCONTROLLED ENVIRONMENT WITH TEMPERATURES BEYOND THE DEVICE'S PERMITTED STORAGE TEMPERATURES (SEE CHAPTER 1) TO PREVENT DAMAGE.**

FCC Statement

Warning!



This device complies with Part 15 FCC Rules. Operation is subject to the following two conditions: (1) this device may not cause harmful interference, and (2) this device must accept any interference received including interference that may cause undesired operation.

Caution:

There is a danger of explosion if the battery is incorrectly replaced. Replace only with the same or equivalent type recommended by the manufacturer. Dispose of used batteries according to the manufacturer's instructions and your local government's recycling or disposal directives.

Attention:

Il y a un risque d'explosion si la batterie est remplacée de façon incorrecte. Ne la remplacer qu'avec le même modèle ou équivalent recommandé par le constructeur. Recycler les batteries usées en accord avec les instructions du fabricant et les directives gouvernementales de recyclage.

产品中有毒有害物质或元素名称及含量

AAEON System

QO4-381 Rev.A0

部件名称	有毒有害物质或元素					
	铅 (Pb)	汞 (Hg)	镉 (Cd)	六价铬 (Cr(VI))	多溴联苯 (PBB)	多溴二苯 醚(PBDE)
印刷电路板 及其电子组件	×	○	○	○	○	○
外部信号 连接器及线材	×	○	○	○	○	○
外壳	○	○	○	○	○	○
中央处理器 与内存	×	○	○	○	○	○
硬盘	×	○	○	○	○	○
液晶模块	×	×	○	○	○	○
光驱	×	○	○	○	○	○
触控模块	×	○	○	○	○	○
电源	×	○	○	○	○	○
电池	×	○	○	○	○	○

本表格依据 SJ/T 11364 的规定编制。

○：表示该有毒有害物质在该部件所有均质材料中的含量均在 GB/T 26572 标准规定的限量要求以下。

×：表示该有害物质的某一均质材料超出了 GB/T 26572 的限量要求，然而该部件仍符合欧盟指令 2011/65/EU 的规范。

备注：

- 一、此产品所标示之环保使用期限，系指在一般正常使用状况下。
- 二、上述部件物质中央处理器、内存、硬盘、光驱、电源为选购品。
- 三、上述部件物质液晶模块、触控模块仅一体机产品适用。

Hazardous and Toxic Materials List

AAEON System

QO4-381 Rev.A0

Component Name	Hazardous or Toxic Materials or Elements					
	Lead (Pb)	Mercury (Hg)	Cadmium (Cd)	Hexavalent Chromium (Cr(VI))	Polybrominated biphenyls (PBBS)	Polybrominated ethers (PBDES)
PCB and Components	X	O	O	O	O	O
Wires & Connectors for Ext.Connections	X	O	O	O	O	O
Chassis	O	O	O	O	O	O
CPU & RAM	X	O	O	O	O	O
HDD Drive	X	O	O	O	O	O
LCD Module	X	X	O	O	O	O
Optical Drive	X	O	O	O	O	O
Touch Control Module	X	O	O	O	O	O
PSU	X	O	O	O	O	O
Battery	X	O	O	O	O	O

This form is prepared in compliance with the provisions of SJ/T 11364.

O: The level of toxic or hazardous materials present in this component and its parts is below the limit specified by GB/T 26572.

X: The level of toxic of hazardous materials present in the component exceed the limits specified by GB/T 26572, but is still in compliance with EU Directive 2011/65/EU (RoHS 2).

Notes:

1. The Environment Friendly Use Period indicated by labelling on this product is applicable only to use under normal conditions.
2. Individual components including the CPU, RAM/memory, HDD, optical drive, and PSU are optional.
3. LCD Module and Touch Control Module only applies to certain products which feature these components.

Table of Contents

Chapter 1 - Product Specifications	1
1.1 Specifications	2
Chapter 2 – Hardware Information	5
2.1 Dimensions	6
2.2 Jumpers and Connectors.....	7
2.3 List of Jumpers	8
2.3.1 Setting Jumpers	8
2.3.2 M.2 SATA/PCIe Mode (JP1)	9
2.3.3 Auto Power Mode (JP2)	9
2.3.4 FAN Voltage Mode (JP3)	9
2.3.5 AGX Orin RTC Mode (Default) (JP4)	9
2.4 List of Connectors.....	10
2.4.1 RTC Connector (CN1).....	11
2.4.2 HDMI Connector (CN3)	11
2.4.3 Dual USB 3.2 Type-A Connector (CN33).....	12
2.4.4 Power-In Connector (CN25)	13
2.4.5 Giga LAN Connector (CN4/CN31).....	13
2.4.6 COM Port Connector (/dev/ttyTHS1) (CN9, SW2).....	14
2.4.7 COM Port Connector (/dev/ttyTHS4) (CN8, SW1).....	16
2.4.8 RS-232/422/485 Select (SW1, SW2)	18
2.4.9 UART Debug Port Connector (CN22)	18
2.4.10 Front Panel Connector (CN18).....	19
2.4.11 USB 3.0 Type-C Connector (CN32)	20
2.4.12 MicroSD Connector (CN17)	21
2.4.13 Audio Connector (CN12)	22
2.4.14 M.2 2230 E-Key Connector (CN13).....	23

2.4.15	M.2 2280 M-Key Connector (SATA or NVM) (CN14).....	24
2.4.16	SATA Connector (CN28).....	25
2.4.17	DIO Port Connector (CN30).....	26
2.4.18	Micro USB Connector (Flash OS) (CN34).....	27
2.4.19	M.2 3052 B-Key (USB3+PCIe) Connector (CN6)	28
2.5	Hardware Assembly	29
2.5.1	M.2 Expansion Module Installation.....	29
2.5.2	2.5" HDD or SSD Installation.....	30
2.5.3	Wall Mount Installation.....	31
Chapter 3 – BSP Flash Guide.....		32
3.1	Before Installation.....	33
3.2	Connecting to PC/ Force Recovery Mode.....	34
3.3	Flash Image to Board.....	36
3.4	Check BSP Version.....	37
Chapter 4 – OS User Guide.....		38
4.1	Introduction	39
4.2	Update Note.....	40
4.3	BOXER-8641AI Power Mode	41

Chapter 1

Product Specifications

1.1 Specifications

System

AI Accelerator	NVIDIA® Jetson AGX Orin™
CPU	NVIDIA® Jetson AGX Orin™ 32GB: 8-core Arm® Cortex®-A78AE v8.2 64-bit CPU NVIDIA® Jetson AGX Orin™ 64GB: 12-core Arm® Cortex®-A78AE v8.2 64-bit CPU
System Memory	32GB LPDDR5 64GB LPDDR5
Storage Device	64GB eMMC 5.1 x 1 MicroSD Slot x 1 SATA Drive Bay x 1
Display Interface	HDMI 2.0 x 1
Ethernet	RJ-45 x 2 (GbE LAN)
I/O	USB 3.2 Gen 2 x 2 (USB Type A) USB 3.2 Gen 2 x 1 (USB Type C) USB 2.0 x 1 (USB Type A) Micro USB x 1 for OS Flash DB-9 x 2 for RS-232/422/485 DB-9 x 1 for DIO x 8 Mic-in and Line-out x 1 MicroSD Card Slot x 1 Reset Button x 1 Recovery Button x 1

System

	Antenna Opening x 4
	Power Button x 1
Expansion	M.2 2230 E-Key x 1 (for Wi-Fi/BT)
	M.2 3052 B-Key x 1
	M.2 2280 M-Key (for NVMe) x 1
	2.5" SATA Port Drive x 1
	SIM Slot x 1
Indicator	Power LED x 1
OS Support	Linux (NVIDIA Jetpack™ 5.0 or above)

Power Supply

Power Requirement	12V DC with lockable DC Jack
--------------------------	------------------------------

Mechanical

Mounting	Wall mount kit
Dimensions (W x D x H)	7.09 " x 5.35 " x 3.11" (180.0mm x 136.0mm x 79.1mm)
Gross Weight	7.8 lb. (3.5Kg)
Net Weight	5.5 lb. (2.5Kg)

Environmental

Operating Temperature	-4°F ~ 131°F (-20°C ~ 55°C) with 0.5 m/s airflow and Industrial Wide Temp. SSD
Storage Temperature	-40°F ~ 158°F (-40°C ~ 70°C)

Environmental

Storage Humidity	5 ~ 95% @ 40°C, non-condensing
Anti-Vibration	3.5Grm / 5~500Hz / operation: eMMC, MicroSD or SSD
Anti-Shock	50G peak acceleration (11 msec. duration: eMMC, Micro SD, or SSD)
Certification	CE/FCC Class B

Note: AAEON recommends using industrial wide-temperature Gen 3 storage.

If using Gen 4 storage, a thermal solution is required for adequate heat dissipation. For any queries regarding these requirements, please contact your AAEON representative.

Note: The real USB, LAN and COM transmission rate depends on the user scenario and the real USB, LAN and COM transmission rate depends on the user scenario and HW design.

Chapter 2

Hardware Information

2.1 Dimensions

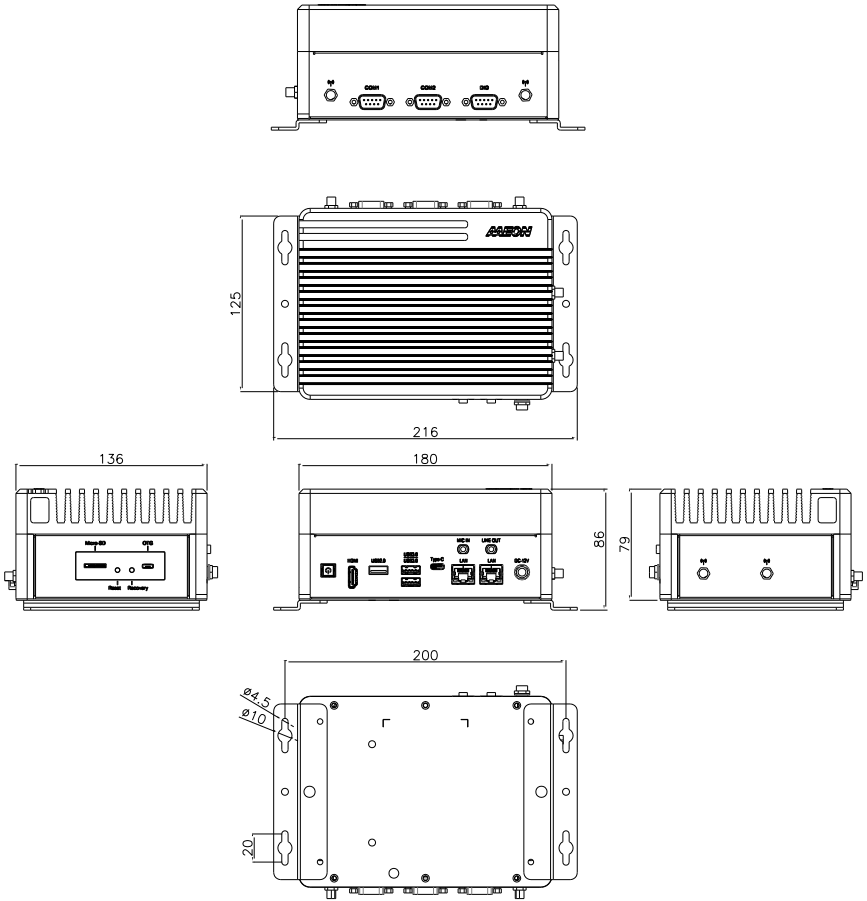

2.2 Jumpers and Connectors

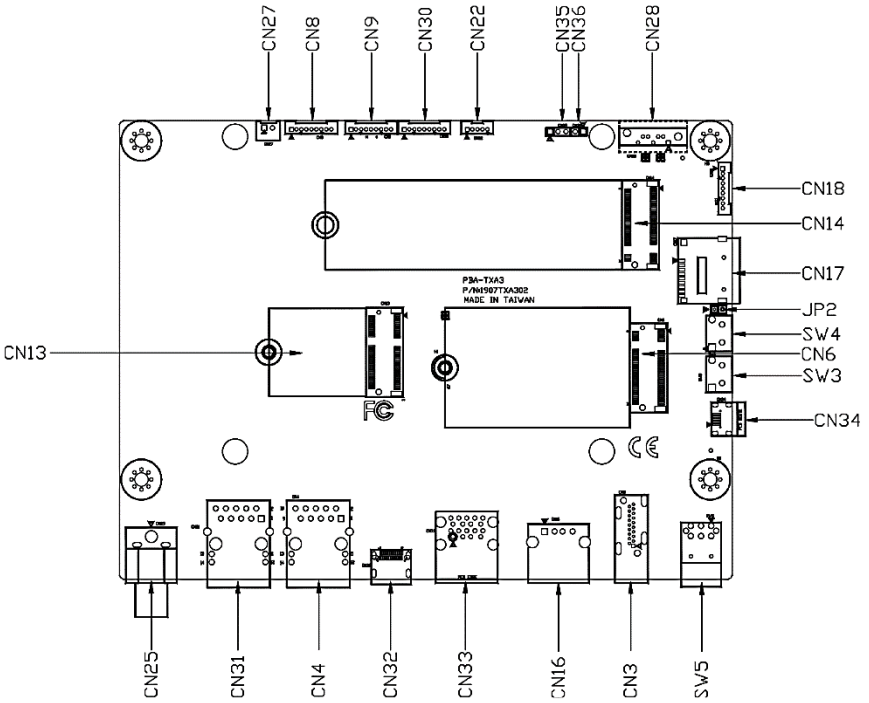

2.3 List of Jumpers

The board has a number of jumpers that allow you to configure your system to suit your application.

The table below shows the function of each of the board's jumpers

Label	Function
JP1	M.2 SATA/PCIe Mode Select
JP2	AT/ATX Mode Select
JP3	FAN Voltage Select
JP4	AGX Orin/Xavier Select

2.3.1 Setting Jumpers

You configure your card to match the needs of your application by setting jumpers. A jumper is the simplest kind of electric switch. It consists of two metal pins and a small metal clip (often protected by a plastic cover) that slides over the pins to connect them. To “close” a jumper you connect the pins with the clip.

To “open” a jumper you remove the clip. Sometimes a jumper will have three pins, labeled 1, 2 and 3. In this case you would connect either pins 1 and 2 or 2 and 3.

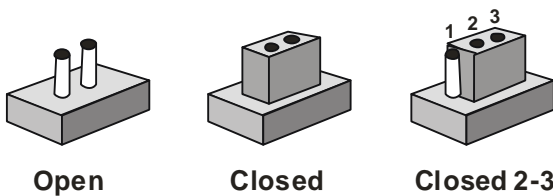

A pair of needle-nose pliers may be helpful when working with jumpers.

If you have any doubts about the best hardware configuration for your application, contact your local distributor or sales representative before you make any change.

Generally, you simply need a standard cable to make most connections.

2.3.2 M.2 SATA/PCIe Mode (JP1)

JP1	Function
1-2	SATA
2-3	PCIe (Default)

2.3.3 Auto Power Mode (JP2)

JP2	Function
1-2 Open	ATX (Default)
1-2 Closed	AT

2.3.4 FAN Voltage Mode (JP3)

JP3	Function
1-2	+5V (Default)
2-3	+12V

2.3.5 AGX Orin RTC Mode (Default) (JP4)

JP4	Function
2-4, 4-6	AGX Xavier

2.4 List of Connectors

The board has a number of connectors that allow you to configure your system to suit your application.

The table below shows the function of each of the board's connectors

Label	Function
CN1	RTC Battery Connector
CN3	HDMI Connector
CN4	Giga LAN Connector
CN6	M.2 B-Key (USB3.0+PCIe) Connector
CN7	SIM Card
CN8	COM Port Connector (/dev/ttyTHS1)
CN9	COM Port Connector (/dev/ttyTHS4)
CN12	Audio Connector
CN13	M.2 2230 E-Key Connector
CN14	M.2 2280 M-Key (SATA or NVM) Connector
CN16	USB 2.0 Type-A Connector
CN17	MicroSD Connector
CN18	Front Panel Connector
CN20	FAN Connector
CN22	UART Debug Port
CN25	DC 12V Plug Connector
CN27	5V SATA Power Connector
CN28	SATA Connector
CN30	8-bit GPIO
CN31	Giga LAN Connector
CN32	USB 3.2 Type-C Connector
CN33	Dual USB 3.2 Type-A Connector
CN34	Micro USB for Flash OS
SW3	Recovery Switch
SW4	Reset Switch
SW5	Power On/Off Switch

2.4.1 RTC Connector (CN1)

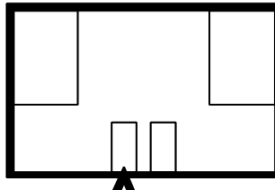

Pin	Signal	Pin	Signal
1	+3V	2	GND

2.4.2 HDMI Connector (CN3)

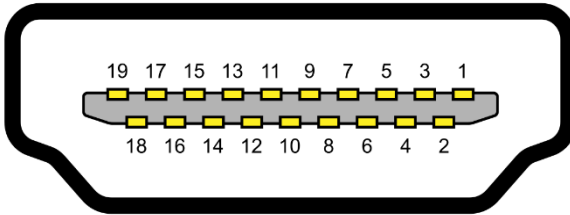

Pin	Signal	Pin	Signal
1	HDMI_DATA2_P	2	GND
3	HDMI_DATA2_N	4	HDMI_DATA1_P
5	GND	6	HDMI_DATA1_N
7	HDMI_DATA0_P	8	GND
9	HDMI_DATA0_N	10	HDMI_CLK_P
11	GND	12	HDMI_CLK_N
13	NC	14	NC
15	HDMI_SCL	16	HDMI_SDA
17	GND	18	HDMI_PWR
19	HDMI_HDP		

2.4.3 Dual USB 3.2 Type-A Connector (CN33)

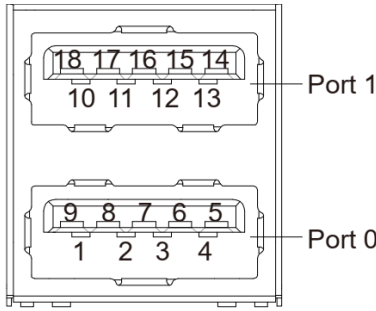

Pin	Signal	Pin	Signal
U1	VBUS_1	U10	VBUS_2
U2	(A)D-	U11	(B)D-
U3	(A)D+	U12	(B)D+
U4	GND	U13	GND
U5	(A)SSRX-	U14	(B)SSRX-
U6	(A)SSRX+	U15	(B)SSRX+
U7	GND	U16	GND
U8	(A)SSTX-	U17	(B)SSTX-
U9	(A)SSTX+	U18	(B)SSTX+

2.4.4 Power-In Connector (CN25)



Pin	Signal	Pin	Signal
1	PWR_IN	2	GND

2.4.5 Giga LAN Connector (CN4/CN31)

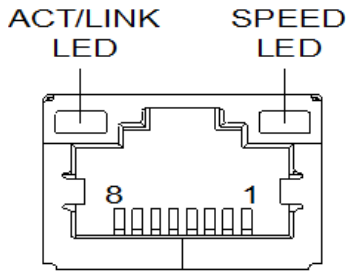

Pin	Signal	Pin	Signal
1	MDI0+	2	MDI0-
3	MDI1+	4	MDI1-
5	MDI2+	6	MDI2-
7	MDI3+	8	MDI3-

2.4.6 COM Port Connector (/dev/ttyTHS1) (CN9, SW2)

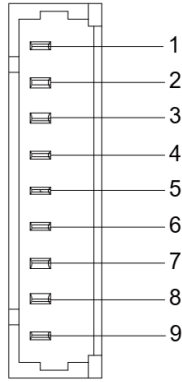

Pin	RS-232	RS-422	RS-485
1		TXD-	TXD-
2			
3	RXD	RXD+	TXD+
4			
5	TXD	TXD+	
6			
7		RXD-	
8			
9	GND	GND	GND

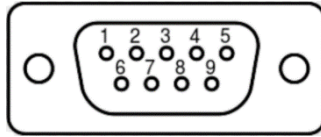

Pin	RS-232	RS-422	RS-485
1		TX-	D-
2	RXD	TX+	D+
3	TXD	RX+	
4		RX-	
5	GND		
6			
7			
8			
9			

2.4.7 COM Port Connector (/dev/ttyTHS4) (CN8, SW1)

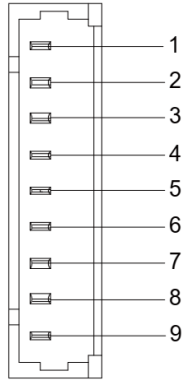

Pin	RS-232	RS-422	RS-485
1		TXD-	TXD-
2			
3	RXD	RXD+	TXD+
4			
5	TXD	TXD+	
6			
7		RXD-	
8			
9	GND	GND	GND

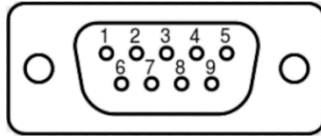

Pin	RS-232	RS-422	RS-485
1		TX-	D-
2	RXD	TX+	D+
3	TXD	RX+	
4		RX-	
5	GND		
6			
7			
8			
9			

2.4.8 RS-232/422/485 Select (SW1, SW2)

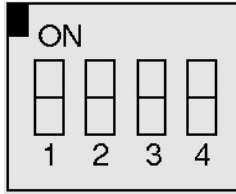

Mode	S-1	S-2	S-3	S-4
1T/1R RS-232	On	On		
1T/1R RS-422	On	Off		
1T/1R RS-485	Off	On		
Low power shutdown	Off	Off		
Enable RS-422/RS-485 bias and termination resistors.			On	
Disable RS-422/RS-485 bias and termination resistors.			Off	
250kbps for RS-232 and RS-485/RS-422				On
RS-232 to 3Mbps and RS-485/RS-422 to 20Mbps				Off

2.4.9 UART Debug Port Connector (CN22)

Pin	Signal
1	VCC 3.3V
2	UART RX
3	GND
4	UART TX
5	GND

2.4.10 Front Panel Connector (CN18)

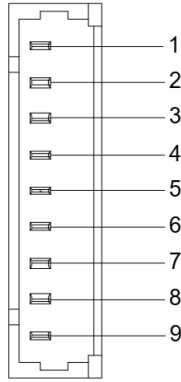

Pin	Signal	Pin	Signal
1	Carrier board standby	2	GND
3	Button power	4	CVM_PRSENT1
5	System Overcurrent indicator	6	GND
7	LED Green	8	LED Blue
9	LED Power (105ohm Pu)		

2.4.11 USB 3.0 Type-C Connector (CN32)

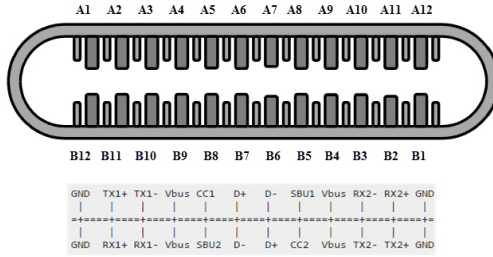

Pin	Signal	Pin	Signal
A1	GND	B12	GND
A2	(A)SSTX+	B11	(B)SSRX+
A3	(A)SSTX-	B10	(B)SSRX-
A4	VBUS_1	B9	VBUS_2
A5	CC1	B8	SBU2
A6	(A)D+	B7	(B)D-
A7	(A)D-	B6	(B)D+
A8	SBU1	B5	CC2
A9	VBUS_1	B4	VBUS_2
A10	(A)SSRX-	B3	(B)SSTX-
A11	(A)SSRX+	B2	(B)SSTX+
A12	GND	B1	GND

2.4.12 MicroSD Connector (CN17)

SD Card Pin Map

Pin No (Card)	Pin No (Connector)	Function
1	#1	DAT2
2	#2	CD/DAT3
3	#3	CMD
4	#4	VDD
5	#5	CLK
6	#6	VSS
7	#7	DAT0
8	#8	DAT1

2.4.13 Audio Connector (CN12)

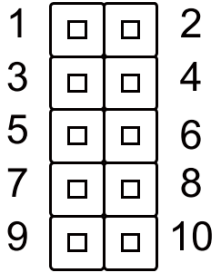

Pin	Signal	Pin	Signal
1	MIC1	2	GND
3	MIC2	4	GPIO4
5	HPO_R	6	MIC_IN_DET
7	GND	8	
9	HPO_L	10	GPIO3

GPIO3: Headphone or jack detection.

GPIO4: Presence – detects if audio dongle is connected to header.

2.4.14 M.2 2230 E-Key Connector (CN13)

74	3.3V	GND	75
72	3.3V	RESERVED/REFCLKn1	73
70	UIIM_POWER_SRC/GPIO1/PEWAKE1#	RESERVED/REFCLKp1	71
68	UIIM_POWER_SNK/CLKREQ1#	GND	69
66	UIIM_SWP/PERST1#	RESERVED/PETn1	67
64	RESERVED	RESERVED/PETp1	65
62	ALERT# (O)(0/3.3V)	GND	63
60	I2C_CLK (I)(0/3.3V)	RESERVED/PERn1	61
58	I2C_DATA (I/O)(0/3.3V)	RESERVED/PERp1	59
56	W_DISABLE1# (I)(0/3.3V)	GND	57
54	W_DISABLE2# (I)(0/3.3V)	PEWAKE0# (I/O)(0/3.3V)	55
52	PERST0# (I)(0/3.3V)	CLKREQ0# (I/O)(0/3.3V)	53
50	SUSCLK(32kHz) (I)(0/3.3V)	GND	51
48	COEX1 (I/O)(0/1.8V)	REFCLKn0	49
46	COEX2(I/O)(0/1.8V)	REFCLKp0	47
44	COEX3(I/O)(0/1.8V)	GND	45
42	VENDOR DEFINED	PETn0	43
40	VENDOR DEFINED	PETp0	41
38	VENDOR DEFINED	GND	39
36	UART CTS (I)(0/1.8V)	PERn0	37
34	UART RTS (O)(0/1.8V)	PERp0	35
32	UART RXD (I)(0/1.8V)	GND	33
	Module Key	Module Key	
	Module Key	Module Key	
	Module Key	Module Key	
	Module Key	Module Key	
22	UART TXD (O)(0/1.8V)	SDIO RESET# (I)(0/1.8V)	23
20	UART WAKE# (O)(0/3.3V)	SDIO WAKE# (O)(0/1.8V)	21
18	GND	SDIO DATA3(I/O)(0/1.8V)	19
16	LED2# (O)(OD)	SDIO DATA2(I/O)(0/1.8V)	17
14	PCM_IN/I2S SD_IN (I)(0/1.8V)	SDIO DATA1(I/O)(0/1.8V)	15
12	PCM_OUT/I2S SD_OUT (O)(0/1.8V)	SDIO DATAQ(I/O)(0/1.8V)	13
10	PCM_SYNC/I2S WS (I/O)(0/1.8V)	SDIO CMD(I/O)(0/1.8V)	11
8	PCM_CLK/I2S SCK (I/O)(0/1.8V)	SDIO CLK(I)(0/1.8V)	9
6	LED1# (O)(OD)	GND	7
4	3.3V	USB_D-	5
2	3.3V	USB_D+	3
		GND	1

2.4.15 M.2 2280 M-Key Connector (SATA or NVM) (CN14)

74	3.3V	GND	75
72	3.3V	GND	73
70	3.3V	GND	71
68	SUSCLK(32kHz) (O)(Q/3.3V)	PEDET (NC-PCIe/GND-SATA)	69
	Connector Key	N/C	67
	Connector Key	Connector Key	
	Connector Key	Connector Key	
	Connector Key	Connector Key	
58	N/C	GND	57
56	N/C	REFCLKp	55
54	PEWAKE# (I/O)(Q/3.3V) or N/C	REFCLKn	53
52	CLKREQ# (I/O)(Q/3.3V) or N/C	GND	51
50	PERST# (O)(Q/3.3V) or N/C	PETpQ/SATA-A+	49
48	N/C	PETnQ/SATA-A-	47
46	N/C	GND	45
44	N/C	PERpQ/SATA-B-	43
42	N/C	PERnQ/SATA-B+	41
40	N/C	GND	39
38	DEVSLP (O)	PETp1	37
36	N/C	PETn1	35
34	N/C	GND	33
32	N/C	PERp1	31
30	N/C	PERn1	29
28	N/C	GND	27
26	N/C	PETp2	25
24	N/C	PETn2	23
22	N/C	GND	21
20	N/C	PERp2	19
18	3.3V	PERn2	17
16	3.3V	GND	15
14	3.3V	PETp3	13
12	3.3V	PETn3	11
10	DAS/DSS# (I/O)/LED1# (I)(O/3.3V)	GND	9
8	N/C	PERp3	7
6	N/C	PERn3	5
4	3.3V	GND	3
2	3.3V	GND	1

2.4.16 SATA Connector (CN28)

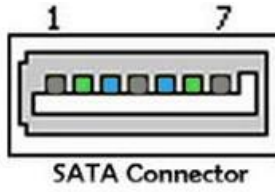

Pin	Signal
1	GND
2	TX+
3	TX-
4	GND
5	RX+
6	RX-
7	GND

2.4.17 DIO Port Connector (CN30)

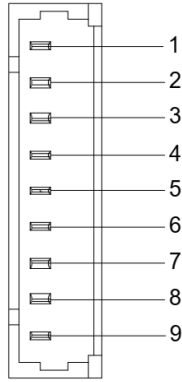

Pin	Function	Voltage Level
1	GPIO493	3.3V-
2	GPIO492	3.3V-
3	GPIO491	3.3V-
4	GPIO494	3.3V-
5	GPIO495	3.3V-
6	GPIO422	3.3V-
7	GPIO393	3.3V-
8	GPIO344	3.3V-
9	GND	GND

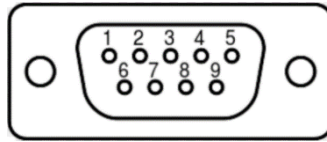

Pin	Function	Pin Name	GPIO No.	Voltage Level
1	GPIO493	PZ.05	483	3.3V-
2	GPIO491	PZ.07	485	3.3V-
3	GPIO495	PZ.03	481	3.3V-
4	GPIO393	PN.01	433	3.3V-
5	GND	GND	GND	GND
6	GPIO492	PZ.04	482	3.3V-
7	GPIO494	PQ.06	454	3.3V-
8	GPIO422	PZ.06	484	3.3V-
9	GPIO344	PH.00	391	3.3V-

2.4.18 Micro USB Connector (Flash OS) (CN34)

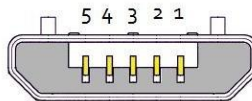

USB Micro-B

Pin	Signal	Pin	Signal
1	+5V	2	USB1-
3	USB1+	4	
5	GND		

2.4.19 M.2 3052 B-Key (USB3+PCIe) Connector (CN6)

74	3.3 V/VBAT	CONFIG_2	75
72	3.3 V/VBAT	GND	73
70	3.3 V/VBAT	GND	71
68	SUSCLK(32kHz) (O)(0/3.3V)	CONFIG_1	69
66	SIM DETECT (O)	RESET# (O)(0/1.8V)	67
64	COEX_RXD (I)(0/1.8V)	ANTCTL3 (I)(0/1.8V)	65
62	COEX_TXD (O)(0/1.8V)	ANTCTL2 (I)(0/1.8V)	63
60	COEX3 (I/O)(0/1.8V)	ANTCTL1 (I)(0/1.8V)	61
58	NC	ANTCTL0 (I)(0/1.8V)	59
56	NC	GND	57
54	PEWAKE# (I/O)(0/3.3V)	REFCLKp	55
52	CLKREQ# (I/O)(0/3.3V)	REFCLKn	53
50	PERST# (O)(0/3.3V)	GND	51
48	GPIO_4 (I/O)(0/1.8V)	PETp0	49
46	GPIO_3 (I/O)(0/1.8V)	PETn0	47
44	GPIO_2 (I/O)/ALERT# (I)(0/1.8V)	GND	45
42	GPIO_1 (I/O)/SMB_DATA (I/O)(0/1.8V)	PERp0	43
40	GPIO_0 (I/O)/SMB_CLK (I/O)(0/1.8V)	PERn0	41
38	DEVSLP (O)	GND	39
36	UIM-PWR (I)	PETp1/USB3.1-Tx+/SSIC-TxP	37
34	UIM-DATA (I/O)	PETn1/USB3.1-Tx-/SSIC-TxN	35
32	UIM-CLK (I)	GND	33
30	UIM-RESET (I)	PERp1/USB3.1-Rx+/SSIC-RxP	31
28	GPIO_8 (I/O) (0/1.8V)	PERn1/USB3.1-Rx-/SSIC-RxN	29
26	GPIO_10 (I/O) (0/1.8V)	GND	27
24	GPIO_7 (I/O) (0/1.8V)	DPR (O) (0/1.8V)	25
22	GPIO_6 (I/O)(0/1.8V)	GPIO_11 (I/O) (0/1.8V)	23
20	GPIO_5 (I/O)(0/1.8V)	CONFIG_0	21
	Key B	Key B	
	Key B	Key B	
	Key B	Key B	
	Key B	Key B	
	Key B	GND	11
10	GPIO_9/DAS/DSS (I/O)/LED_1# (I)(0/3.3V)	USB_D-	9
8	W_DISABLE1# (O)(0/3.3V)	USB_D+	7
6	FULL_CARD_POWER_OFF# (O)(0/1.8V or 3.3V)	GND	5
4	3.3 V	GND	3
2	3.3 V	CONFIG_3	1

2.5 Hardware Assembly

This section details the steps needed to install various hardware components for the BOXER-8641AI.

2.5.1 M.2 Expansion Module Installation

The M.2 2280 M-Key, M.2 2230 E-Key, and M.2 3052 B-Key slots can be accessed via removable covers on the bottom panel of the BOXER 8641AI system as shown in the following diagram.

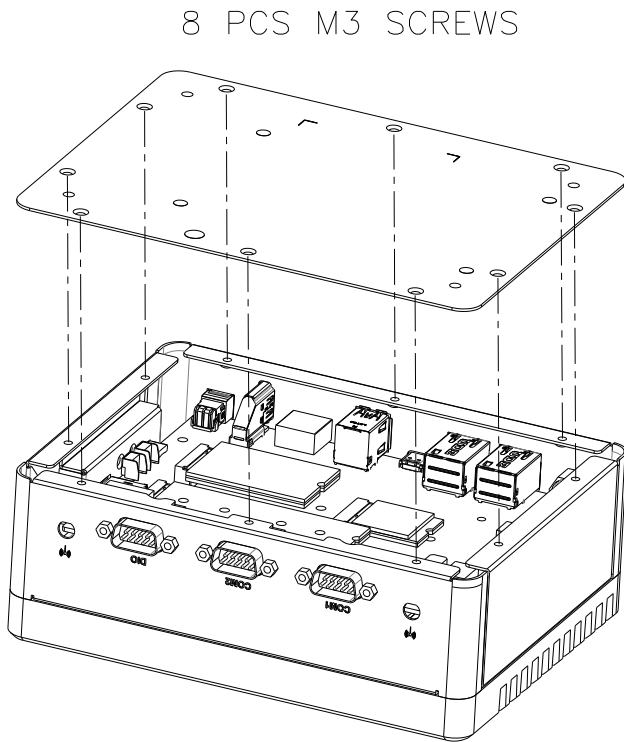

2.5.2 2.5" HDD or SSD Installation

The 2.5" HDD or SSD drive bay can be accessed for drive installation via removable covers on the bottom panel of the BOXER 8641AI system as shown in the following diagram.

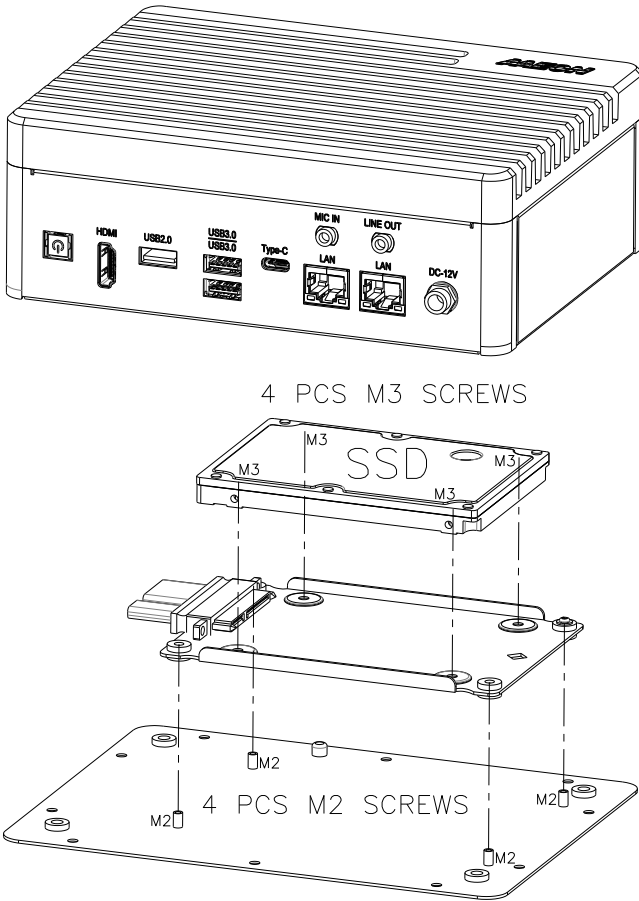

2.5.3 Wall Mount Installation

The BOXER 8641AI can be secured via a wall mount as shown in the following diagram.

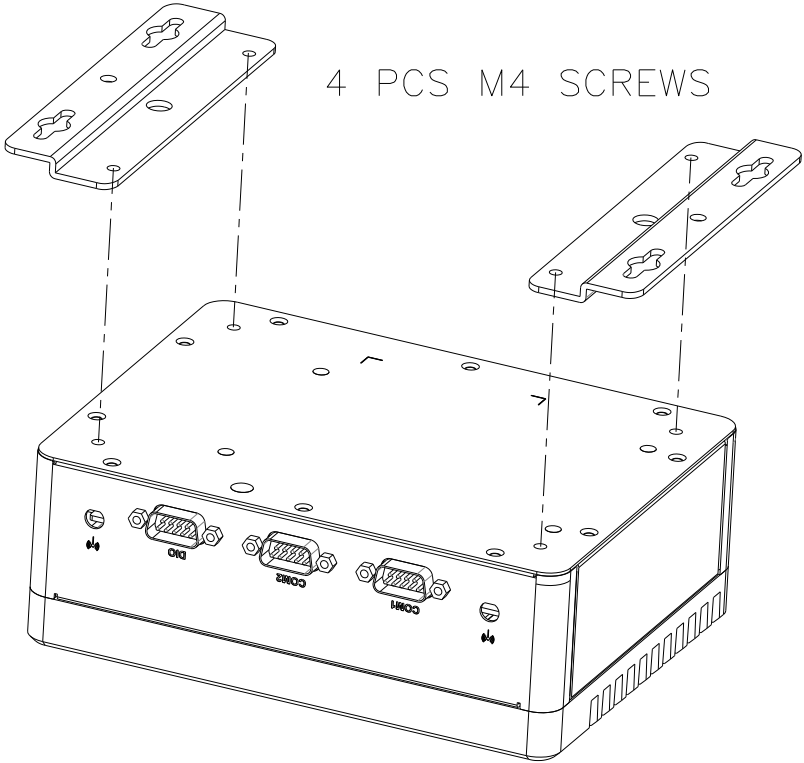

Chapter 3

BSP Flash Guide

3.1 Before Installation

Before starting the process make sure your BOXER-8641AI system is turned off and the power is disconnected. You will need a Host PC running Ubuntu 18.04, and make sure the NVIDIA Jetson Orin AGX module is installed onto the BOXER-8641AI carrier board system.

Note: Do not use a virtual machine as a host PC, as some virtual machines may have unstable USB connections which can cause the flash procedure to fail.



Download the compressed BSP image file "**Internal.tar.gz**" into the Host Ubuntu 18.04 PC directory.

Note: No spaces, special characters, or non-English characters can be used for the name of the folder where the file is stored, or its parent folder.

Ensure the language settings of Ubuntu 18.04 are set to English, and the format setting is the United States, to prevent flash failure.

3.2 Connecting to PC/ Force Recovery Mode

Step 1:

On the Host computer, open Linux terminal and enter the following command to extract the compressed BSP image files (BSP file name may vary):

```
$ sudo tar -zxvf Internal.tar.gz
```

Note: Do not decompress the file (Internal.tar.gz) using a Windows OS, BSP should only be decompressed in a Linux EXT3/4 file system.

Step 2:

Perform the following actions to force the system to start in USB Recovery Mode:

1. Connect the Micro-USB plug on the USB cable to the Recovery Port on the BOXER-8641AI, and the other end to an available USB port on the Host PC.
2. Connect the BOXER-8641AI to a power supply.
3. Press and hold the recovery key button. While holding the recovery key button, power on the system, and continue to hold the recovery key button for two seconds, then release. The BOXER-8641AI should then enter recovery mode.
4. To check if device is in recovery mode, enter the command `lsusb` in terminal on Host.

```
$ lsusb | grep "0955:7223"
```

If successful, the command will return "0955:7223 Nvidia Corp"

```
Bus 001 Device 003: ID 0955:7223 NVidia Corp.
```

Note: Recovery mode cannot be initiated if the NVIDIA Jetson Orin AGX module is disassembled. Ensure the NVIDIA Jetson Orin AGX module is installed and refer to the image below to perform the steps:

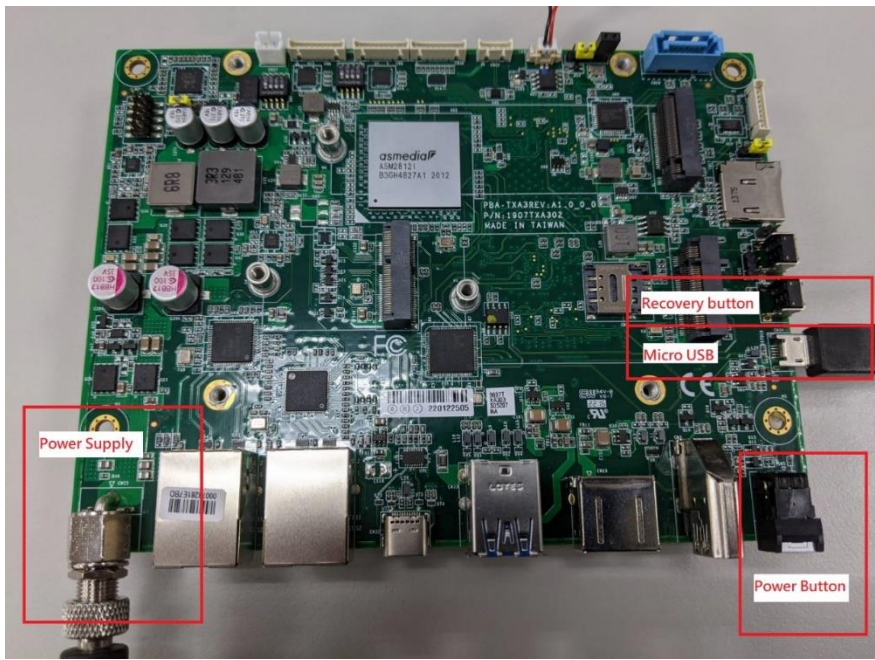

3.3 Flash Image to Board

Use the following steps to flash the OS to the BOXER-8641AI.

1) Open terminal on the Ubuntu Host PC, then access the folder you extracted in the previous section.

2) Enter the following command in terminal to flash the image:

```
$ sudo ./flashboxer.sh
```

3) Wait as the image is installed. Once complete you should see the following:

```
[ 883.0285 ] Flashing completed
[ 883.0287 ] Coldbooting the device
[ 883.0328 ] tegrarc_m_v2 --chip 0x23 --ismb2
[ 883.0363 ] MB2 version 01.00.0000
[ 883.1397 ]
[ 883.1399 ] Coldbooting the device
[ 883.1443 ] tegrarc_m_v2 --chip 0x23 --reboot coldboot
[ 883.1479 ] MB2 version 01.00.0000
[ 883.2727 ]
*** The target t186ref has been flashed successfully. ***
Reset the board to boot from internal eMMC.
```

3.4 Check BSP Version

Once the flash image is successfully installed, the BOXER-8641AI will reboot automatically, then check the BSP version to see if the system is flashing the correct version of BSP.

Open a Terminal, and type command “`cat /proc/product`”

```
aaeon@localhost:~$ cat /proc/product
BOXER-8641AI_J5.0.2_E00_1.0.0_20220817
BOXER-8641AI.Ubuntu20.04_AGXORINJP5.0.2_V1.0.0_17/08/2022
```

The version name will follow the format of:

`{PJ_IF}.` `{OS_IF}``_{PLF_IF}``{JPV_IF}``_{IMGV_IF}``_{BD_IF}`

For example:

`BOXER-8641AI.Ubuntu20.04_AGXORINJP5.0.2_V1.0.0_17/08/2022`

Note: Filename may differ from this example.

`{OS_IF}` is OS Information; e.g. Ubuntu20.04

`{PLF_IF}` is Platform Information; e.g. AGXORIN

`{PJ_IF}` is Project Information; e.g. BOXER-8641AI

`{IMGV_IF}` is Build Number; e.g. v1.0.0

`{JPV_IF}` is Jetpack Version; e.g. jp5.0.2

`{BD_IF}` is Build Date; e.g. 17/08/2022

Chapter 4

OS User Guide

4.1 Introduction

The BOXER-8641AI's OS, Ubuntu/Linux version, and preinstalled SDK components are as follows:

For **Jetpack 5.0.2 (L4t 35.1)**

1. Ubuntu/Linux version:
 - a. Ubuntu version: 20.04.4
 - b. Kernel version: 5.10.104-tegra
 - c. UEFI version: EFI v2.70 by EDK II
2. Built-in Jetson SDK Components:
 - a. CUDA Toolkit for L4T 11.4
 - b. cuDNN 8.4
 - c. TensorRT 8.4
 - d. OpenCV 4.5
 - e. VPI 2.1
 - f. NVIDIA Container Runtime 1.10
 - g. Multimedia API 35.1
 - h. Nsight Systems 2022.3
 - i. Nsight Graphics 2022.3
 - j. Nsight Compute 2022.2
 - k. Compute Sanitizer 2022.2
 - l. Nsight DL Designer 2022.1
 - m. Deepstream 6.1.1
3. Built-in Allxon DMS:
 - a. Please refer to vendor website at <https://www.allxon.com/solutions>

Default login user/password is:

Account: **aaeon**

Password: **aaeon**.

4.2 Update Note

Running `$ sudo apt upgrade` command in terminal will overwrite the **Aaeon kernel device tree(.dtb)/kernel image(Image)/bootloader** in the OS, which can lead to unexpected results, including the loss of I/O ports.

So Aaeon default disable Nvidia apt Repo for updating Nvidia apt package.

AAEON maintains updated versions of BSP on the product page, which follow updates to the NVIDIA Jetpack software. Contact your AAEON representative or visit the product page to download the latest version of Aaeon BSP for your system:

<https://www.aaeon.com/en/p/ai-edge-solutions-boxer-8641ai>

4.3 BOXER-8641AI Power Mode

NVIDIA Jetson Orin AGX power mode can be selected and monitored by GUI, please refer to the following picture:

