

BOXER-8521AI

Compact Fanless Embedded AI@Edge Box PC
with Google[®] Edge TPU[™]
User's Manual 1st Ed

Copyright Notice

This document is copyrighted, 2020. All rights are reserved. The original manufacturer reserves the right to make improvements to the products described in this manual at any time without notice.

No part of this manual may be reproduced, copied, translated, or transmitted in any form or by any means without the prior written permission of the original manufacturer. Information provided in this manual is intended to be accurate and reliable. However, the original manufacturer assumes no responsibility for its use, or for any infringements upon the rights of third parties that may result from its use.

The material in this document is for product information only and is subject to change without notice. While reasonable efforts have been made in the preparation of this document to assure its accuracy, AAEMON assumes no liabilities resulting from errors or omissions in this document, or from the use of the information contained herein.

AAEMON reserves the right to make changes in the product design without notice to its users.

Acknowledgements

All other products' name or trademarks are properties of their respective owners.

- Google® and Google Edge TPU™ are trademarks of Google LLC
- ITE is a trademark of Integrated Technology Express, Inc.
- IBM and VGA are trademarks of International Business Machines Corporation.
- Ubuntu is a registered trademark of Canonical

All other product names or trademarks are properties of their respective owners. No ownership is implied or assumed for products, names or trademarks not herein listed by the publisher of this document.

Packing List

Before setting up your product, please make sure the following items have been shipped:

Item	Quantity
● BOXER-8521AI	1

If any of these items are missing or damaged, please contact your distributor or sales representative immediately.

About this Document

This User's Manual contains all the essential information, such as detailed descriptions and explanations on the product's hardware and software features (if any), its specifications, dimensions, jumper/connector settings/definitions, and driver installation instructions (if any), to facilitate users in setting up their product.

Users may refer to the product page at AAEON.com for the latest version of this document.

Safety Precautions

Please read the following safety instructions carefully. It is advised that you keep this manual for future references

1. All cautions and warnings on the device should be noted.
2. All cables and adapters supplied by AAEON are certified and in accordance with the material safety laws and regulations of the country of sale. Do not use any cables or adapters not supplied by AAEON to prevent system malfunction or fires.
3. Make sure the power source matches the power rating of the device.
4. Position the power cord so that people cannot step on it. Do not place anything over the power cord.
5. Always completely disconnect the power before working on the system's hardware.
6. No connections should be made when the system is powered as a sudden rush of power may damage sensitive electronic components.
7. If the device is not to be used for a long time, disconnect it from the power supply to avoid damage by transient over-voltage.
8. Always disconnect this device from any AC supply before cleaning.
9. While cleaning, use a damp cloth instead of liquid or spray detergents.
10. Make sure the device is installed near a power outlet and is easily accessible.
11. Keep this device away from humidity.
12. Place the device on a solid surface during installation to prevent falls
13. Do not cover the openings on the device to ensure optimal heat dissipation.
14. Watch out for high temperatures when the system is running.
15. Do not touch the heat sink or heat spreader when the system is running
16. Never pour any liquid into the openings. This could cause fire or electric shock.

17. As most electronic components are sensitive to static electrical charge, be sure to ground yourself to prevent static charge when installing the internal components. Use a grounding wrist strap and contain all electronic components in any static-shielded containers.
18. If any of the following situations arises, please the contact our service personnel:
 - i. Damaged power cord or plug
 - ii. Liquid intrusion to the device
 - iii. Exposure to moisture
 - iv. Device is not working as expected or in a manner as described in this manual
 - v. The device is dropped or damaged
 - vi. Any obvious signs of damage displayed on the device
19. **DO NOT LEAVE THIS DEVICE IN AN UNCONTROLLED ENVIRONMENT WITH TEMPERATURES BEYOND THE DEVICE'S PERMITTED STORAGE TEMPERATURES (SEE CHAPTER 1) TO PREVENT DAMAGE.**

FCC Statement

Warning!



This device complies with Part 15 FCC Rules. Operation is subject to the following two conditions: (1) this device may not cause harmful interference, and (2) this device must accept any interference received including interference that may cause undesired operation.

Caution:

There is a danger of explosion if the battery is incorrectly replaced. Replace only with the same or equivalent type recommended by the manufacturer. Dispose of used batteries according to the manufacturer's instructions and your local government's recycling or disposal directives.

Attention:

Il y a un risque d'explosion si la batterie est remplacée de façon incorrecte. Ne la remplacer qu'avec le même modèle ou équivalent recommandé par le constructeur. Recycler les batteries usées en accord avec les instructions du fabricant et les directives gouvernementales de recyclage.

产品中有毒有害物质或元素名称及含量

AAEON System

QO4-381 Rev.A0

部件名称	有毒有害物质或元素					
	铅 (Pb)	汞 (Hg)	镉 (Cd)	六价铬 (Cr(VI))	多溴联苯 (PBB)	多溴二苯 醚(PBDE)
印刷电路板 及其电子组件	×	○	○	○	○	○
外部信号 连接器及线材	×	○	○	○	○	○
外壳	○	○	○	○	○	○
中央处理器 与内存	×	○	○	○	○	○
硬盘	×	○	○	○	○	○
液晶模块	×	×	○	○	○	○
光驱	×	○	○	○	○	○
触控模块	×	○	○	○	○	○
电源	×	○	○	○	○	○
电池	×	○	○	○	○	○

本表格依据 SJ/T 11364 的规定编制。

○：表示该有毒有害物质在该部件所有均质材料中的含量均在 GB/T 26572 标准规定的限量要求以下。

×：表示该有害物质的某一均质材料超出了 GB/T 26572 的限量要求，然而该部件仍符合欧盟指令 2011/65/EU 的规范。

备注：

- 一、此产品所标示之环保使用期限，系指在一般正常使用状况下。
- 二、上述部件物质中央处理器、内存、硬盘、光驱、电源为选购品。
- 三、上述部件物质液晶模块、触控模块仅一体机产品适用。

Hazardous and Toxic Materials List

AAEON System

QO4-381 Rev.A0

Component Name	Hazardous or Toxic Materials or Elements					
	Lead (Pb)	Mercury (Hg)	Cadmium (Cd)	Hexavalent Chromium (Cr(VI))	Polybrominated biphenyls (PBBS)	Polybrominated diphenyl ethers (PBDES)
PCB and Components	X	O	O	O	O	O
Wires & Connectors for Ext.Connections	X	O	O	O	O	O
Chassis	O	O	O	O	O	O
CPU & RAM	X	O	O	O	O	O
HDD Drive	X	O	O	O	O	O
LCD Module	X	X	O	O	O	O
Optical Drive	X	O	O	O	O	O
Touch Control Module	X	O	O	O	O	O
PSU	X	O	O	O	O	O
Battery	X	O	O	O	O	O

This form is prepared in compliance with the provisions of SJ/T 11364.

O: The level of toxic or hazardous materials present in this component and its parts is below the limit specified by GB/T 26572.

X: The level of toxic of hazardous materials present in the component exceed the limits specified by GB/T 26572, but is still in compliance with EU Directive 2011/65/EU (RoHS 2).

Notes:

1. The Environment Friendly Use Period indicated by labelling on this product is applicable only to use under normal conditions.
2. Individual components including the CPU, RAM/memory, HDD, optical drive, and PSU are optional.
3. LCD Module and Touch Control Module only applies to certain products which feature these components.

Table of Contents

Chapter 1 - Product Specifications	1
1.1 Specifications	2
1.2 Product Notice	4
Chapter 2 – Hardware Information	5
2.1 Dimensions	6
2.2 Jumpers and connectors.....	8
2.3 List of Jumpers	10
2.3.1 Setting Jumpers	10
2.3.2 COM Port Mode Select Header (JP1)	11
2.4 List of Connectors.....	13
2.4.1 Google Edge TPU Module Connector (CN1).....	14
2.4.2 Google Edge TPU Module Connector (CN2).....	16
2.4.3 Google Edge TPU Module Connector (CN3).....	18
2.4.4 40-Pin Expansion Header (CN4)	21
2.4.5 HDMI Port (CN5)	23
2.4.6 Dual USB 3.2 Gen 1 Port (CN6)	24
2.4.7 Micro USB Port (CN7).....	25
2.4.8 Dual USB 2.0 Port (CN8).....	25
2.4.9 Fan Control Connector (CN9).....	26
2.4.10 COM Port Connector (CN11).....	26
2.4.11 Micro SD Card Slot (CN12)	27
2.4.12 DC-In Jack (CN13).....	28
2.4.13 LAN with PoE PD Port (CN14).....	28
2.4.14 Line Out 3.5mm Jack (CN15).....	29
2.4.15 Mic In 3.5mm Jack (CN16)	30
2.4.16 DMIC Connector (CN17/18).....	30

2.4.17	MIPI CSI Connector (P1)	31
2.4.18	System Reset Button (SW1)	32
2.4.19	Boot Mode Select Switch (SW2).....	33
2.5	Hardware Assembly	34
Chapter 3 – OS Flash Guide		35
3.1	Before Installation.....	36
3.2	Connecting to PC/Entering Fastboot Mode	37
3.3	Flash Image to Board.....	40

Chapter 1

Product Specifications

1.1 Specifications

System

AI Accelerator	Google Edge TPU ML accelerator coprocessor
CPU	NXP i.MX 8M SoC (Quad-core Cortex-A53, plus Cortex-M4F)
System Memory	1GB LPDDR4x
Storage Device	8GB eMMC
Display Interface	HDMI 2.0 x 1
Ethernet	10/100/1000Base-TX x 1
I/O	HDMI 2.0a x 1 USB Type A x 2 for USB3.2 Gen 1 USB Type A x 2 for USB2.0 RJ-45 x 1 for GbE LAN & PoE/PD (802.3at) 12Vdc (DC Jack w/lockable) Mic -in x 1 Line-out x 1 40-pin I/O x 1 (GPIO/I2C/SAI/SPI/UART/PWM) DB-9 x 1 for RS-232/485 OS Flash port x 1 (Micro USB) Micro-SD slot x 1
Expansion	—
Indicator	Power LED x 1
OS Support	ACLinux 4.0 (Compatible with Debian 10)

Power Supply

Power Requirement	POE/PD (802.3at) 12Vdc (DC Jack w/lockable)
--------------------------	--

Mechanical

Mounting	Wall mount
Dimensions (W x D x H)	6.92" x 3.94" x 1.54" (175.8 mm x 100.0 mm x 39.0 mm)
Gross Weight	2.31 lbs. (1.05 kg)
Net Weight	1.28 lbs. (0.58 kg)

Environmental

Operating Temperature	23°F ~ 122°F (-5°C ~ 50°C, according to IEC60068-2 with 0.5 m/s airflow)
Storage Temperature	-49°F ~ 176°F (-45°C ~ 80°C)
Storage Humidity	95% @ 40°C, non-condensing
Anti-Vibration	Random, 3.5 Grms, 5~500Hz
Certification	CE/FCC class A

1.2 Product Notice

Micro-USB: Micro-USB port is ideally for flashing image only.

USB ports: USB ports do not support USB DVD ROM because of file system.

USB 3.2 Gen 1: USB 3.2 Gen 1 is the current name for 5Gbps specification, formerly USB 3.0.

LAN Indicator Behavior: Yellow LED indicates 100Mbps speed and activity. Green LED indicates 1000Mbps speed and activity.

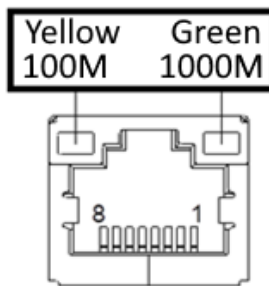

Chapter 2

Hardware Information

2.1 Dimensions

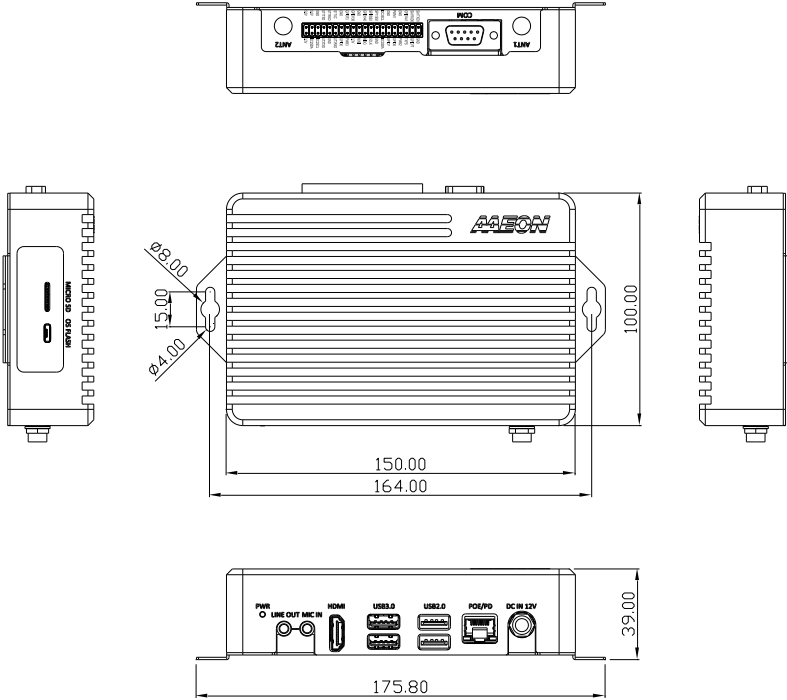

2.2 Jumpers and connectors

Board Top

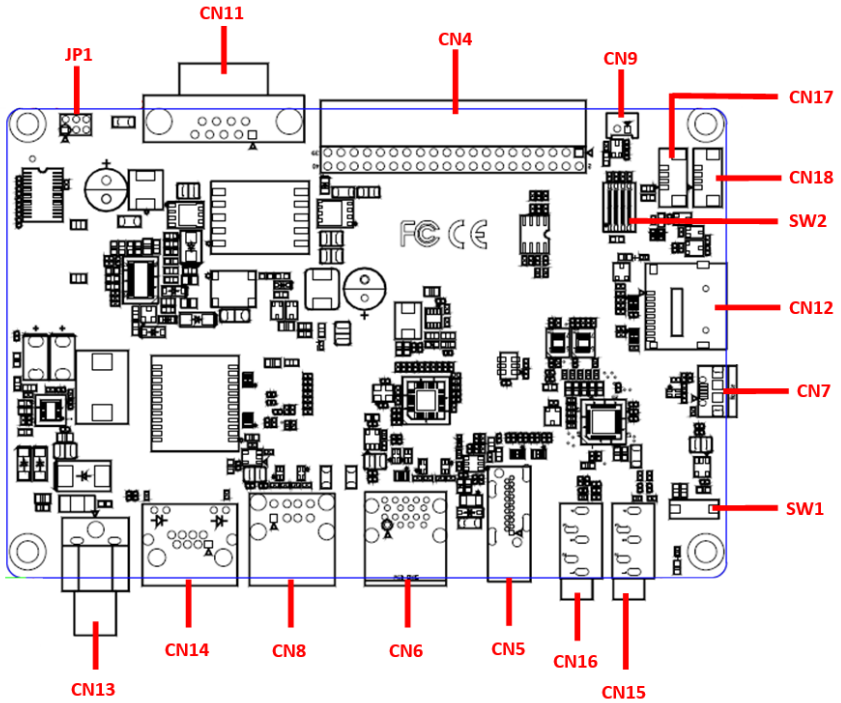

Board Bottom

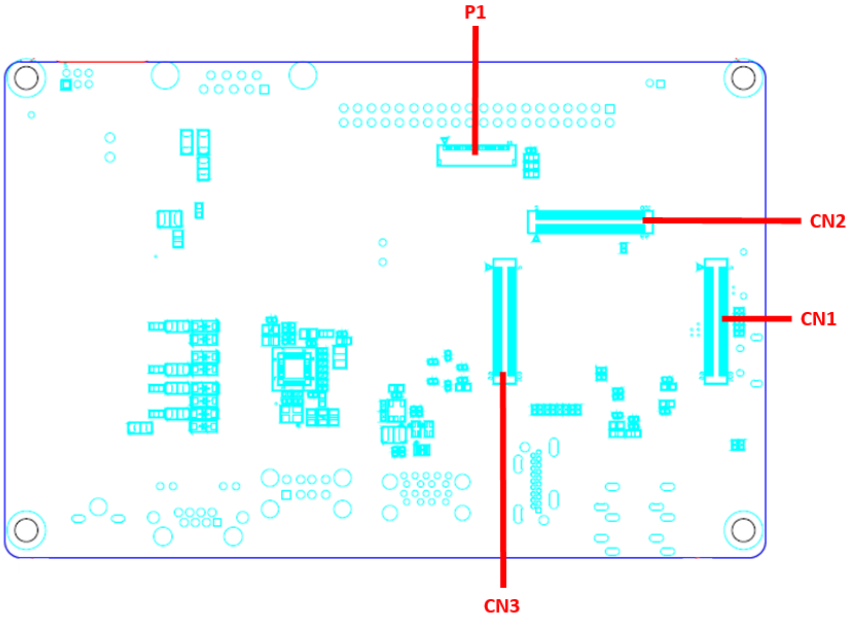

2.3 List of Jumpers

The board has a number of jumpers that allow you to configure your system to suit your application.

The table below shows the function of each of the board's jumpers

Label	Function
JP1	COM Port Mode Select Header

2.3.1 Setting Jumpers

You can configure your system to match the needs of your application by setting jumpers. A jumper is the simplest kind of electric switch. It consists of two metal pins and a small metal clip (often protected by a plastic cover) that slides over the pins to connect them. To “close” a jumper you connect the pins with the clip.

To “open” a jumper you remove the clip. Sometimes a jumper will have three pins, labeled 1, 2 and 3. In this case you would connect either pins 1 and 2 or 2 and 3.

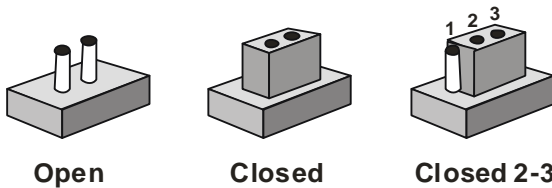

A pair of needle-nose pliers may be helpful when working with jumpers.

If you have any questions about the best hardware configuration for your application, contact your local distributor or sales representative before you make any changes.

Generally, you simply need a standard cable to make most connections.

2.3.2 COM Port Mode Select Header (JP1)

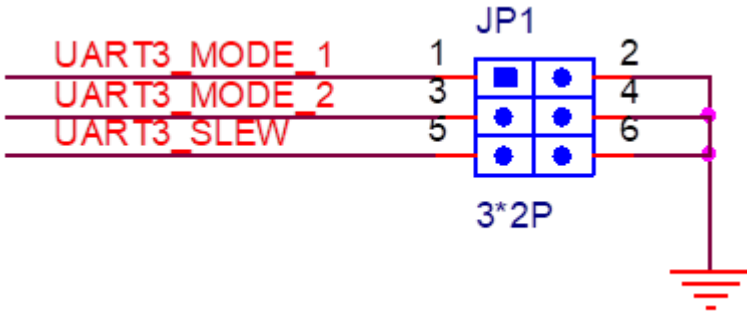
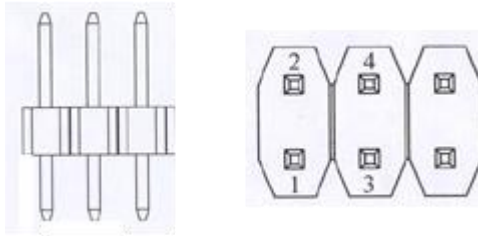

COM Port Mode can be set by configuring Pins 1-2 and Pins 3-4 to be open or closed.

Mode Select			
SD	MODE_1	MODE_2	
Closed	Closed	Open	RS232
Closed	Open	Closed	RS485: RX
Closed	Open	Open	RS485: TX

Slew Rate Control is set by Pins 5-6

Slew Rate Control		
SLEW	RS-232	RS-485
Closed	1Mbps	10Mbps
Open	250kbps	250kbps

JP1 Pin Definitions

Pin	Pin Name	Signal Type	Signal Level
1	UART3_MODE_1		
2	GND	GND	
3	UART3_MODE_2		
4	GND	GND	
5	UART3_SLEW		
6	GND	GND	

Note: Only connect pins in pairs of 1-2, 3-4, 5-6. To avoid unwanted operation or damage to the system, do not connect pins in any other configuration.

2.4 List of Connectors

The board has a number of connectors that allow you to configure your system to suit your application.

The table below shows the function of each of the board's connectors

Label	Function
CN1/CN2/CN3	Google Edge TPU module Connectors
CN4	40-pin Expansion Header
CN5	HDMI Port
CN6	Dual USB3.2 Gen1 Port
CN7	Micro USB Port (OTG)
CN8	Dual USB2.0 Port
CN9	FAN Control Connector
CN11	RS-232/RS-485 COM Port
CN12	Micro-SD Card Slot
CN13	DC-in Jack
CN14	LAN with PoE-PD Port
CN15	Line-out 3.5mm Jack
CN16	Mic-in 3.5mm Jack
CN17/CN18	DMIC Connector
P1	MIPI CSI Connector
SW1	System RESET Button
SW2	Boot Mode Select Switch

2.4.1 Google Edge TPU Module Connector (CN1)

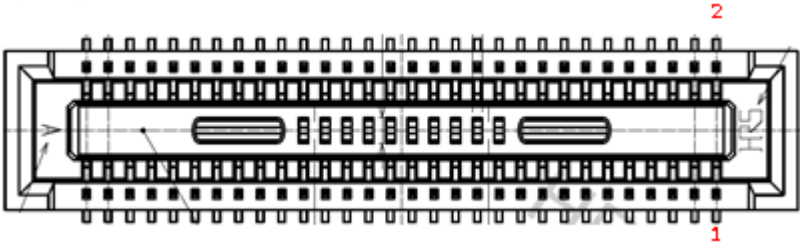

Pin	Signal	Pin	Signal
1	ECSPI2_SS0	2	ECSPI2_SCLK
3	ECSPI2_MISO	4	ECSPI1_SCLK
5	ECSPI1_MISO	6	
7	ECSPI1_MOSI	8	ECSPI1_SS0
9	GND	10	GND
11	PWM4	12	SAI2_MCLK
13		14	SAI2_TXD
15		16	SAI2_TXFS
17		18	SAI2_TXC
19		20	SAI2_RXD
21		22	SAI2_RXC
23		24	SAI2_RXFS
25		26	
27		28	
29		30	SAI1_TXD2
31		32	
33	SAI1_RXD0	34	SAI1_TXD5
35		36	
37		38	SAI1_TXD4

Pin	Signal	Pin	Signal
39	ENET_nINT	40	SAI1_TXC
41		42	
43	ENET_nRST	44	SAI1_TXD0
45	GPIO7	46	SAI1_TXFS
47	GPIO8	48	SAI5_RXD1
49	GPIO6	50	SAI5_MCLK
51	GPIO12	52	SAI5_RXD3
53	JTAG_TCK	54	SAI5_RXD2
55	JTAG_nTRST	56	SAI5_RXC
57	JTAG_TDO	58	SAI5_RXD0
59	JTAG_TMS	60	SAI5_RXFS
61	JTAG_TDI	62	BOOT_MODE1
63	SYS_NRST	64	BOOT_MODE0
65	GND	66	GND
67		68	HDMI_CLK_P
69		70	HDMI_CLK_N
71	GND	72	GND
73	HDMI_TX0_N	74	HDMI_TX2_N
75	HDMI_TX0_P	76	HDMI_TX2_P
77	GND	78	GND
79	HDMI_TX1_P	80	HDMI_AUX_N
81	HDMI_TX1_N	82	HDMI_AUX_P
83	GND	84	GND
85	HDMI_DDC_SDA	86	PWRON_B
87	HDMI_DDC_SCL	88	PWM1
89	HDMI_HPD	90	PWM2

Pin	Signal	Pin	Signal
91	HDMI_CEC	92	PWM3
93	DCDC_5V	94	DCDC_5V
95	DCDC_5V	96	DCDC_5V
97	DCDC_5V	98	DCDC_5V
99	DCDC_5V	100	DCDC_5V

2.4.2 Google Edge TPU Module Connector (CN2)

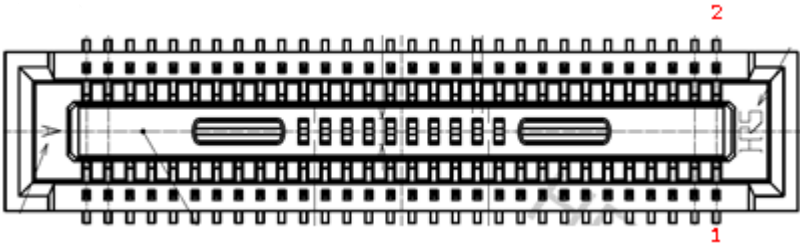

Pin	Signal	Pin	Signal
1	GND	2	GND
3		4	MIPI_CSI1_D2_N
5		6	MIPI_CSI1_D2_P
7	GND	8	GND
9		10	MIPI_CSI1_D0_N
11		12	MIPI_CSI1_D0_P
13	GND	14	GND
15		16	MIPI_CSI1_CLK_N
17		18	MIPI_CSI1_CLK_P
19	GND	20	GND
21	MIPI_CSI1_D1_N	22	
23	MIPI_CSI1_D1_P	24	

Pin	Signal	Pin	Signal
25	GND	26	GND
27	MIPI_CSI1_D3_N	28	
29	MIPI_CSI1_D3_P	30	
31	GND	32	GND
33		34	
35		36	
37	GND	38	GND
39		40	
41		42	
43	GND	44	GND
45		46	
47		48	
49	GND	50	GND
51	USB1_D_P	52	
53	USB1_D_N	54	
55	GND	56	GND
57		58	USB1_TX_P
59		60	USB1_TX_N
61	GND	62	GND
63	USB2_D_P	64	USB1_RX_P
65	USB2_D_N	66	USB1_RX_N
67	GND	68	GND
69	USB2_TX_P	70	USB2_RX_P
71	USB2_TX_N	72	USB2_RX_N
73	GND	74	GND
75	USB2_VBUS	76	USB1_ID

Pin	Signal	Pin	Signal
77	USB2_VBUS	78	
79	GND	80	GND
81	I2C3_SDA	82	USB1_VBUS
83	I2C3_SCL	84	USB1_VBUS
85	I2C2_SDA	86	GND
87	I2C2_SCL	88	
89	GND	90	GND
91	UART3_TXD	92	
93	UART1_TXD	94	GND
95	UART1_RXD	96	
97	UART3_RXD	98	SPDIF_RX
99	GND	100	GND

2.4.3 Google Edge TPU Module Connector (CN3)

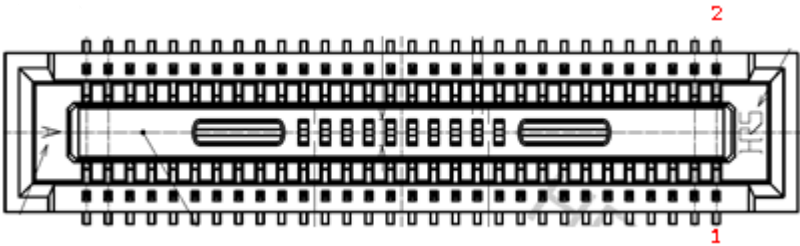

Pin	Signal	Pin	Signal
1	GND	2	GND
3		4	
5		6	ECSPI1_SS1
7	GND	8	
9	ENET_MDIO	10	NAND_CLE

Pin	Signal	Pin	Signal
11	ENET_MDC	12	
13	ENET_TX_CTL	14	
15	ENET_TD3	16	
17	ENET_TD2	18	NAND_DATA07
19	ENET_TD0	20	
21	ENET_TD1	22	NAND_DATA03
23	ENET_TDC	24	SD_nCD
25	GND	26	SD_CMD
27	ENET_RXC	28	SD_DAT0
29	ENET_RX_CTL	30	
31	ENET_RD2	32	SD_DAT1
33	ENET_RD0	34	SD_DAT2
35	ENET_RD1	36	SD_nRST
37	ENET_RD3	38	SD_DAT3
39	GND	40	GND
41		42	GND
43		44	GND
45		46	GND
47		48	SD_CLK
49		50	GND
51		52	
53		54	
55		56	GND
57		58	HDMI_REFCLK_P
59		60	HDMI_REFCLK_N

Pin	Signal	Pin	Signal
61		62	GND
63	GND	64	GND
65	GND	66	GND
67	GND	68	GND
69	GND	70	GND
71	GND	72	GND
73	GND	74	GND
75	GND	76	GND
77	GND	78	GND
79	POR_B	80	GND
81		82	
83	NVCC_ENET_2V5	84	DCDC_3V3
85	NVCC_ENET_2V5	86	DCDC_3V3
87	NVCC_ENET_2V5	88	DCDC_3V3
89		90	DCDC_3V3
91	VDDA_1V8	92	
93	VDDA_1V8	94	VDD_3V3
95	VDDA_1V8	96	VDD_3V3
97	VDDA_1V8	98	VDD_3V3
99	VDDA_1V8	100	VDD_3V3

2.4.4 40-Pin Expansion Header (CN4)

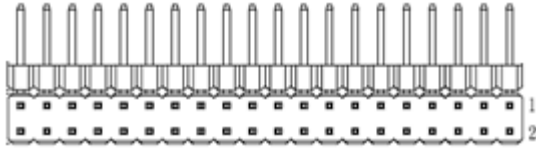

Pin	Pin Name	Signal Type	Signal Level
1	VDD_3V3	PWR	+3.3V
2	DCDC_5V	PWR	+5V
3	I2C2_SDA		
4	DCDC_5V	PWR	+5V
5	I2C2_SCL		
6	GND	GND	
7	UART3_TXD		
8	UART1_TXD		
9	GND	GND	
10	UART1_RXD		
11	UART3_RXD		
12	SAI1_TXC		
13	GPIO6		
14	GND	GND	
15	PWM3		
16	NAND_DATA03		
17	VDD_3V3	PWR	+3.3V
18	ECSPI2_SCLK		
19	ECSPI1_MOSI		
20	GND	GND	
21	ECSPI1_MISO		

Pin	Pin Name	Signal Type	Signal Level
22	ECSPi2_MISO		
23	ECSPi1_SCLK		
24	ECSPi1_SS0		
25	GND	GND	
26	ECSPi1_SS1		
27	I2C3_SDA		
28	I2C3_SCL		
29	GPIO7		
30	GND	GND	
31	GPIO8		
32	PWM1		
33	PWM2		
34	GND	GND	
35	SAI1_TXFS		
36	ECSPi2_SS0		
37	NAND_DATA07		
38	SAI1_RXD0		
39	GND	GND	
40	SAI1_TXD0		

2.4.5 HDMI Port (CN5)

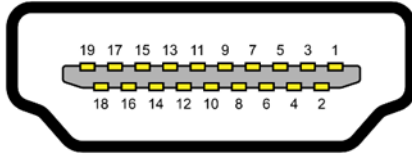

Pin	Pin Name	Signal Type	Signal Level
1	HDMI_TXD2_CON_P	DIFF	
2	GND	GND	
3	HDMI_TXD2_CON_N	DIFF	
4	HDMI_TXD1_CON_P	DIFF	
5	GND	GND	
6	HDMI_TXD1_CON_N	DIFF	
7	HDMI_TXD0_CON_P	DIFF	
8	GND	GND	
9	HDMI_TXD0_CON_N	DIFF	
10	HDMI_TXC_CON_P	DIFF	
11	GND	GND	
12	HDMI_TXC_CON_N	DIFF	
13	HDMI_CEC_CON	IN	+3.3V
14	HDMI_Utility/HEAC+_CN	IN	
15	HDMI_DDC_SCL_5V0	IN	+5V
16	HDMI_DDC_SDA_5V0	IN	+5V
17	GND	GND	
18	VDD_5V0_HDMI_CON	PWR	+5V
19	HDMI_HPD_CON	OUT	

2.4.6 Dual USB 3.2 Gen 1 Port (CN6)

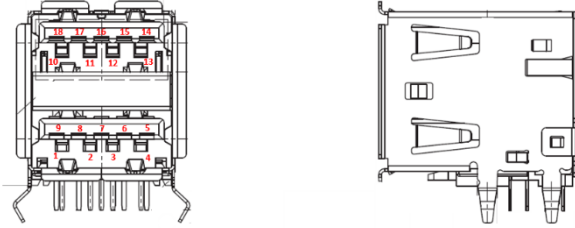

Pin	Pin Name	Signal Type	Signal Level
1	USB_VBUS_2	PWR	+5V
2	USB_HUB_DN2	DIFF	
3	USB_HUB_DP2	DIFF	
4	GND	GND	
5	USB2_RX_N	DIFF	
6	USB2_RX_P	DIFF	
7	GND	GND	
8	USB2_TX_N	DIFF	
9	USB2_TX_P	DIFF	
10	USB_VBUS_1	PWR	+5V
11	USB_HUB_DN1	DIFF	
12	USB_HUB_DP1	DIFF	
13	GND	GND	
14	USB1_RX_N	DIFF	
15	USB1_RX_P	DIFF	
16	GND	GND	
17	USB1_TX_N	DIFF	
18	USB1_TX_P	DIFF	

2.4.7 Micro USB Port (CN7)

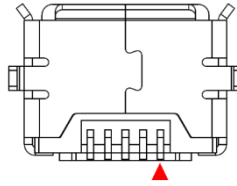

Pin	Pin Name	Signal Type	Signal Level
1	USB1_VBUS	PWR	+5V
2	USB1_D_N	DIFF	
3	USB1_D_P	DIFF	
4	USB1_ID	OUT	
5	GND	GND	

2.4.8 Dual USB 2.0 Port (CN8)

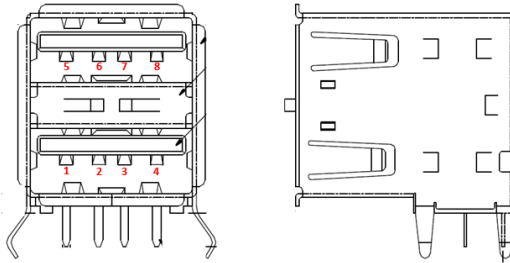

Pin	Pin Name	Signal Type	Signal Level
1	USB_VBUS	PWR	+5V
2	USB_HUB_DN3	DIFF	
3	USB_HUB_DP3	DIFF	
4	GND	GND	
5	USB_VBUS	PWE	+5V

Pin	Pin Name	Signal Type	Signal Level
6	USB_HUB_DN4	DIFF	
7	USB_HUB_DP4	DIFF	
8	GND	GND	

2.4.9 Fan Control Connector (CN9)

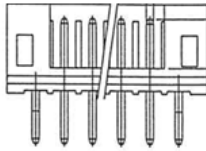

Pin	Pin Name	Signal Type	Signal Level
1	DCDC_5V	PWR	+5V
2	NAND_CLE	OUT	

2.4.10 COM Port Connector (CN11)

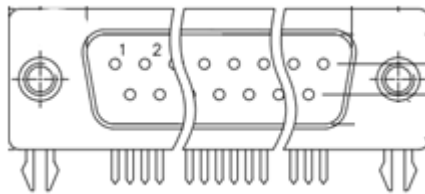

Pin	Pin Name	Signal Type	Signal Level
1	485_D-		
2	RXC_3_485_D+		
3	TXC_3	OUT	
4			
5	GND	GND	

Pin	Pin Name	Signal Type	Signal Level
6			
7			
8			
9			

Note: COM Port Mode and Slew Control can be set by JP1.

2.4.11 Micro SD Card Slot (CN12)

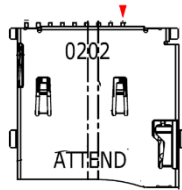

Pin	Pin Name	Signal Type	Signal Level
1	SD_DAT2		+1.8V
2	SD_DAT3		+1.8V
3	SD_CMD	IN	+1.8V
4	VSD_3V3	PWR	+3.3V
5	SD_CLK	IN	
6	GND	GND	
7	SD_DAT0		+1.8V
8	SD_DAT1		+1.8V
9	SD_nCD	OUT	+3.3V
10	GND	GND	

2.4.12 DC-In Jack (CN13)

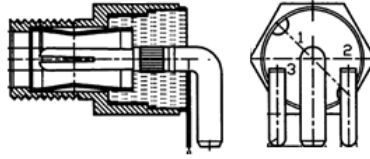

Pin	Pin Name	Signal Type	Signal Level
1	+V12_IN	PWR	
2	GND	GND	
3	GND	GND	

2.4.13 LAN with PoE PD Port (CN14)

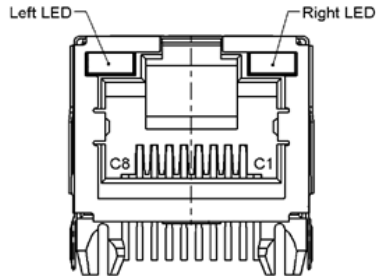

Pin	Pin Name	Signal Type	Signal Level
1	MDIP0_0_TF	DIFF	
2	MDIN0_0_TF	DIFF	
3	MDIP1_0_TF	DIFF	
4	MDIP2_0_TF	DIFF	
5	MDIN2_0_TF	DIFF	
6	MDIN1_0_TF	DIFF	
7	MDIP3_0_TF	DIFF	

Pin	Pin Name	Signal Type	Signal Level
8	MDIN3_0_TF	DIFF	
L1	LED2_1000M/CFG_LDO1_0	IN	
L2	LDO1_0	PWR	+3.3V
L3	LDO0_0	GND	
L4	LED1_100M/CFG_LDO0_0	IN	

2.4.14 Line Out 3.5mm Jack (CN15)

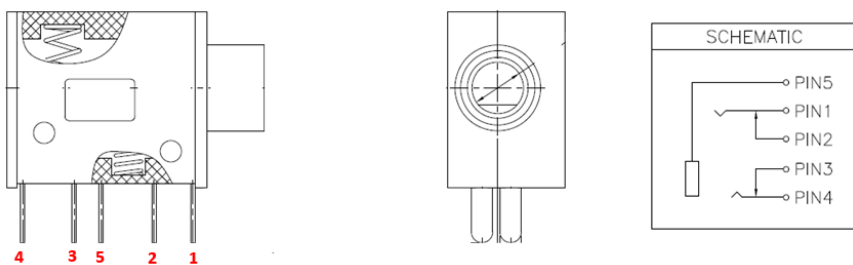

Pin	Pin Name	Signal Type	Signal Level
1	GND_AUDIO	GND	
2	LOUTR	OUT	
3	LOUTL	OUT	
4			
5			

2.4.15 Mic In 3.5mm Jack (CN16)

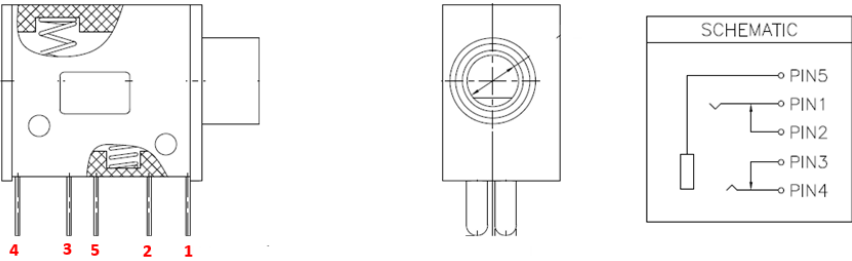

Pin	Pin Name	Signal Type	Signal Level
1	GND_AUDIO	GND	
2	IN2N	IN	
3	IN2P	IN	
4			
5			

2.4.16 DMIC Connector (CN17/18)

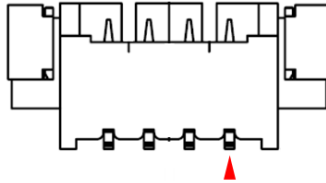

Pin	Pin Name	Signal Type	Signal Level
1	DMIC_PWR	PWR	+1.8V
2	IN1P	IN	
3	DMIC_SCL	OUT	
4	GND	GND	

2.4.17 MIPI CSI Connector (P1)

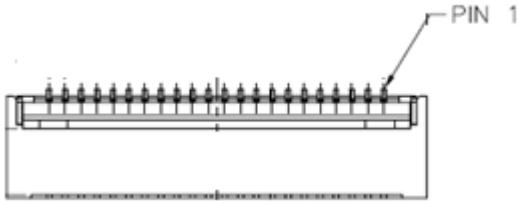

Pin	Pin Name	Signal Type	Signal Level
1	GND	GND	
2	MIPI_CSI1_D0_N	DIFF	
3	MIPI_CSI1_D0_P	DIFF	
4	GND	GND	
5	MIPI_CSI1_CLK_N	DIFF	
6	MIPI_CSI1_CLK_P	DIFF	
7	GND	GND	
8	MIPI_CSI1_D1_N	DIFF	
9	MIPI_CSI1_D1_P	DIFF	
10	GND	GND	
11	MIPI_CSI1_D2_N	DIFF	
12	MIPI_CSI1_D2_P	DIFF	
13	GND	GND	
14	MIPI_CSI1_D3_N	DIFF	
15	MIPI_CSI1_D3_P	DIFF	
16	GND	GND	
17			
18			
19	GND	GND	

Pin	Pin Name	Signal Type	Signal Level
20	I2C2_SCL		
21	I2C2_SDA		
22			
23	GPIO12		
24	VDD_3V3	PWR	+3.3V

2.4.18 System Reset Button (SW1)

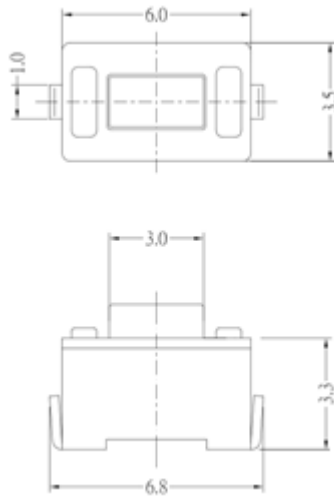

Pin	Pin Name	Signal Type	Signal Level
1	GND	GND	
2	SYS_RST#	OUT	

2.4.19 Boot Mode Select Switch (SW2)

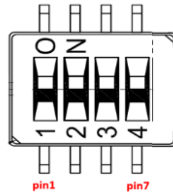

Pin	Pin Name	Signal Type	Signal Level
1	BOOT_MODE1	OUT	
2	VDD_3V3	PWR	+3.3V
3	BOOT_MODE0	OUT	
4	VDD_3V3	PWR	+3.3V
5	SAI1_TXD4	OUT	
6	VDD_3V3	PWR	+3.3V
7	SAI1_TXD5	OUT	
8	GND	GND	

Boot Mode Select		
BMODE 1 (Switch 1)	BMODE 0 (Switch 2)	Boot Type
Off	Off	Boot from Fuses (Production on the line)
Off	On	Serial Downloader (from USB to flash image /MFG)
On	Off	Internal Boot (Software Development)
On	On	Reserved

2.5 Hardware Assembly

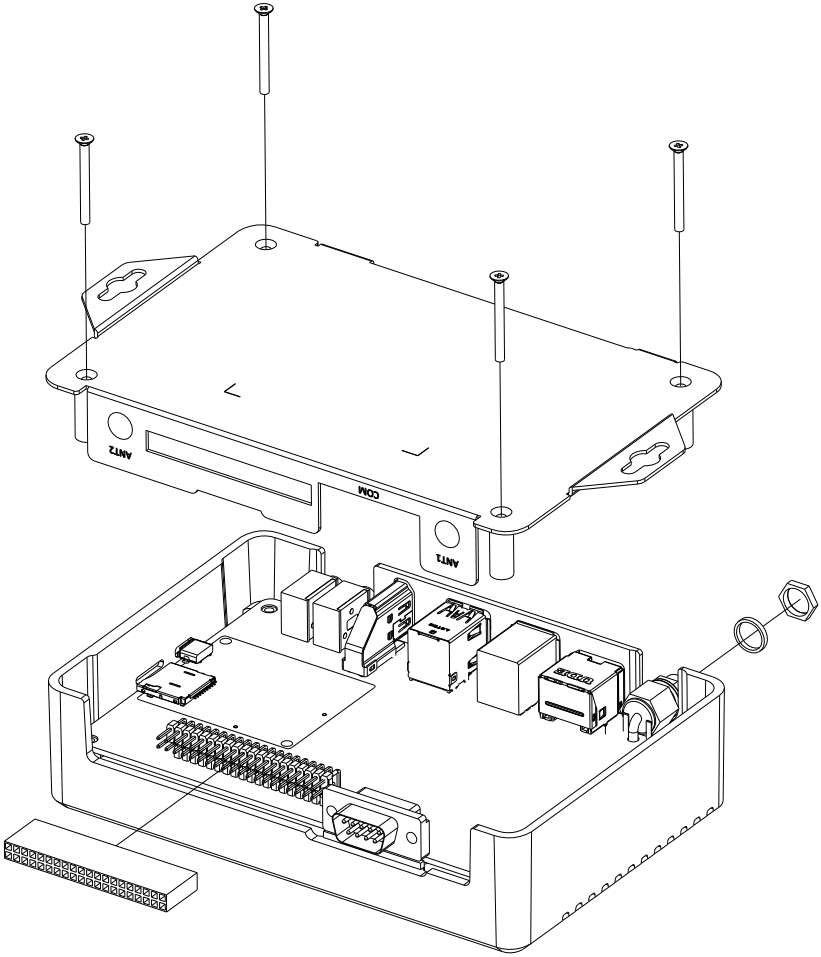

Chapter 3

OS Flash Guide

3.1 Before Installation

Before starting the process make sure your BOXER-8521AI system is turned off and the power in is disconnected. You will need a host PC running Ubuntu 16.04 or 18.04, and make sure the Google Edge TPU module is installed onto the BOXER-8521AI carrier board/ system.

Download the compressed OS image file. The file name will follow the format of:

```
Debian_10_{OS_IF}._{PLF_IF}._{PJ_IF}._{BN}.tar.gz
```

For example:

```
Debian_10_DB100X.GL00.BOXER-8521AI.2.tar.gz
```

Note: Filename may differ from this example.

- I. **{OS_IF}** is OS Information. For example, **DB100X**, DB100 means Debian 10.0, X means desktop version.
- II. **{PLF_IF}** is Platform Information; e.g. **GL00** for Google Edge TPU
- III. **{PJ_IF}** is Project Information; e.g. **BOXER-8521AI**
- IV. **{BN}** is Build Number; e.g. 0, 1, 2, etc.

Note: Flash procedure can be done with the system assembled or with the board removed. Ensure the Google Edge TPU module is properly installed on the carrier board before proceeding.

3.2 Connecting to PC/Entering Fastboot Mode

On Host Computer, open Linux terminal and enter the following command to extract compressed OS image files (*file name may vary*):

```
$ tar -zxvf Debian_10_DB100X.GL00.BOXER-8521AI.2.tar.gz
```

Next, perform the following steps to force the system to start in USB Recovery Mode:

1. Connect the Micro-USB plug on the USB cable to the Recovery Port on the BOXER-8521AI and the other end to an available USB port on the host PC.

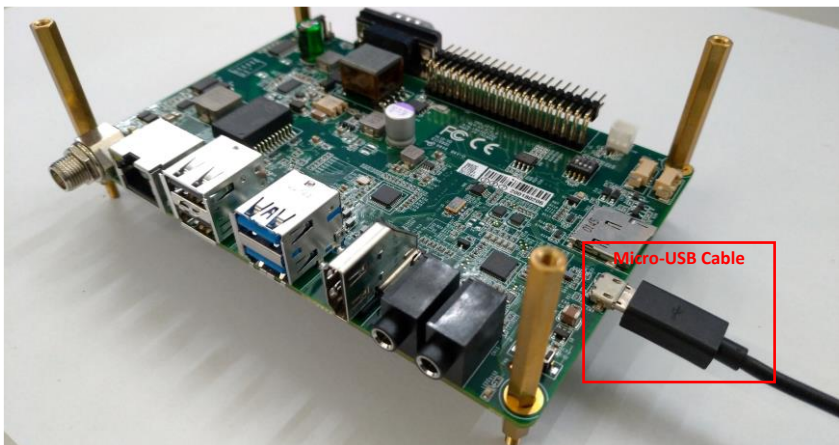

2. Mount the Google Coral SOM on the carrier board.

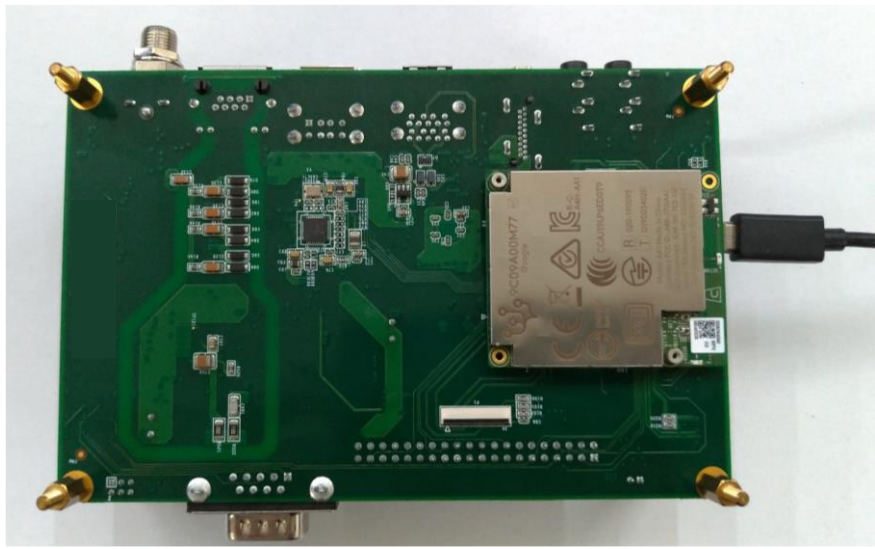

3. Connect the Power Input and boot up the board with Google Coral SOM

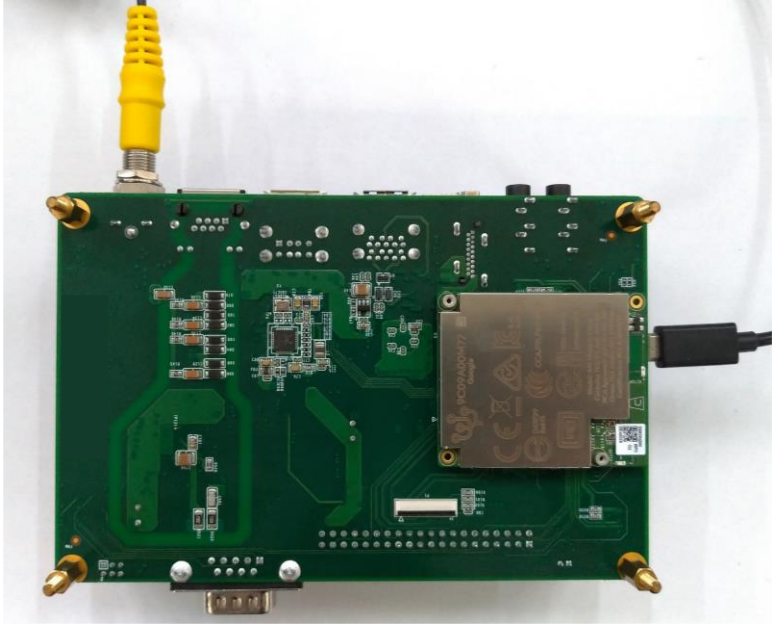

4. Enter fastboot mode by opening terminal and entering the following command:

```
$ sudo reboot-bootloader
```

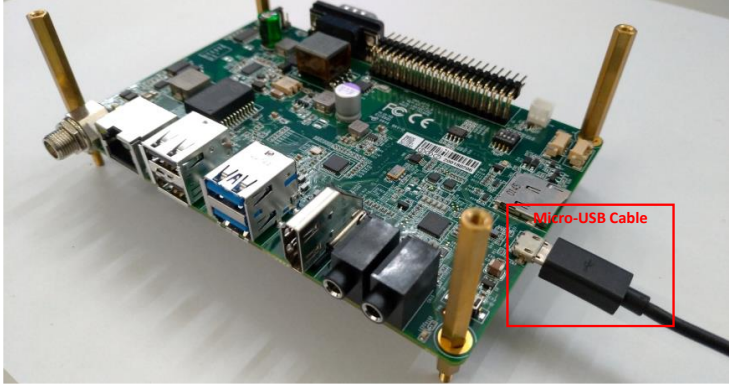

3.3 Flash Image to Board

Use the following steps to flash the OS to the BOXER-8521AI.

1. Open terminal on Ubuntu host PC, then access the bootloader folder you extracted in the previous section.
2. Use fastboot command to check for the device

```
$ ./fastboot devices
```

3. Make sure you are still in the folder with the extracted OS image. Enter the following command in terminal to flash the image:

```
$ sudo ./flash.sh
```

```
~/Downloads/images/Debian_10_DB100X.GL00.BOXER-8521AI.4 $ sudo ./flash.sh
[sudo] password for marble:
target reported max download size of 419430400 bytes
sending 'bootloader0' (991 KB)...
OKAY [ 0.072s]
writing 'bootloader0'...
OKAY [ 0.191s]
finished. total time: 0.263s
rebooting into bootloader...
OKAY [ 0.024s]
finished. total time: 0.125s
target reported max download size of 419430400 bytes
sending 'gpt' (33 KB)...
OKAY [ 0.124s]
writing 'gpt'...
OKAY [ 0.308s]
finished. total time: 0.432s
rebooting into bootloader...
OKAY [ 0.022s]
finished. total time: 0.122s
erasing 'misc'...
OKAY [ 0.072s]
finished. total time: 0.072s
```

4. Wait as the image is installed. Once finished you should see the following:

```
OKAY [ 15.029s]
writing 'rootfs' 2/6...
OKAY [ 14.646s]
sending sparse 'rootfs' 3/6 (403480 KB)...
OKAY [ 15.904s]
writing 'rootfs' 3/6...
OKAY [ 15.005s]
sending sparse 'rootfs' 4/6 (408267 KB)...
OKAY [ 16.305s]
writing 'rootfs' 4/6...
OKAY [ 24.486s]
sending sparse 'rootfs' 5/6 (407517 KB)...
OKAY [ 16.808s]
writing 'rootfs' 5/6...
OKAY [ 19.522s]
sending sparse 'rootfs' 6/6 (150868 KB)...
OKAY [ 6.312s]
writing 'rootfs' 6/6...
OKAY [ 54.501s]
finished. total time: 252.318s
rebooting...

finished. total time: 0.105s
~/Downloads/Images/Debian_10_DB100X.GL00.BOXER-8521AI.4 $
```