

BOXER-8253AI

Compact Fanless Embedded AI@Edge Box PC
with NVIDIA[®] Jetson Xavier™ NX
User's Manual 5th Ed

Copyright Notice

This document is copyrighted, 2022. All rights are reserved. The original manufacturer reserves the right to make improvements to the products described in this manual at any time without notice.

No part of this manual may be reproduced, copied, translated, or transmitted in any form or by any means without the prior written permission of the original manufacturer. Information provided in this manual is intended to be accurate and reliable. However, the original manufacturer assumes no responsibility for its use, or for any infringements upon the rights of third parties that may result from its use.

The material in this document is for product information only and is subject to change without notice. While reasonable efforts have been made in the preparation of this document to assure its accuracy, AAEMON assumes no liabilities resulting from errors or omissions in this document, or from the use of the information contained herein.

AAEMON reserves the right to make changes in the product design without notice to its users.

Acknowledgements

All other products' name or trademarks are properties of their respective owners.

- NVIDIA®, the NVIDIA logo, Jetson™ and Jetson Xavier™ NX are trademarks of the NVIDIA Corporation
- ITE is a trademark of Integrated Technology Express, Inc.
- IBM and VGA are trademarks of International Business Machines Corporation.
- Ubuntu is a registered trademark of Canonical

All other product names or trademarks are properties of their respective owners. No ownership is implied or assumed for products, names or trademarks not herein listed by the publisher of this document.

Packing List

Before setting up your product, please make sure the following items have been shipped:

Item	Quantity
● BOXER-8253AI	1
● Power Connector	1
● Wallmount Bracket	2
● Screw Package	1

If any of these items are missing or damaged, please contact your distributor or sales representative immediately.

About this Document

This User's Manual contains all the essential information, such as detailed descriptions and explanations on the product's hardware and software features (if any), its specifications, dimensions, jumper/connector settings/definitions, and driver installation instructions (if any), to facilitate users in setting up their product.

Users may refer to the product page at AAEON.com for the latest version of this document.

Safety Precautions

Please read the following safety instructions carefully. It is advised that you keep this manual for future references

1. All cautions and warnings on the device should be noted.
2. All cables and adapters supplied by AAEON are certified and in accordance with the material safety laws and regulations of the country of sale. Do not use any cables or adapters not supplied by AAEON to prevent system malfunction or fires.
3. Make sure the power source matches the power rating of the device.
4. Position the power cord so that people cannot step on it. Do not place anything over the power cord.
5. Always completely disconnect the power before working on the system's hardware.
6. No connections should be made when the system is powered as a sudden rush of power may damage sensitive electronic components.
7. If the device is not to be used for a long time, disconnect it from the power supply to avoid damage by transient over-voltage.
8. Always disconnect this device from any AC supply before cleaning.
9. While cleaning, use a damp cloth instead of liquid or spray detergents.
10. Make sure the device is installed near a power outlet and is easily accessible.
11. Keep this device away from humidity.
12. Place the device on a solid surface during installation to prevent falls
13. Do not cover the openings on the device to ensure optimal heat dissipation.
14. Watch out for high temperatures when the system is running.
15. Do not touch the heat sink or heat spreader when the system is running
16. Never pour any liquid into the openings. This could cause fire or electric shock.

17. As most electronic components are sensitive to static electrical charge, be sure to ground yourself to prevent static charge when installing the internal components. Use a grounding wrist strap and contain all electronic components in any static-shielded containers.
18. If any of the following situations arises, please the contact our service personnel:
 - i. Damaged power cord or plug
 - ii. Liquid intrusion to the device
 - iii. Exposure to moisture
 - iv. Device is not working as expected or in a manner as described in this manual
 - v. The device is dropped or damaged
 - vi. Any obvious signs of damage displayed on the device
19. **DO NOT LEAVE THIS DEVICE IN AN UNCONTROLLED ENVIRONMENT WITH TEMPERATURES BEYOND THE DEVICE'S PERMITTED STORAGE TEMPERATURES (SEE CHAPTER 1) TO PREVENT DAMAGE.**

FCC Statement

Warning!



This device complies with Part 15 FCC Rules. Operation is subject to the following two conditions: (1) this device may not cause harmful interference, and (2) this device must accept any interference received including interference that may cause undesired operation.

Caution:

There is a danger of explosion if the battery is incorrectly replaced. Replace only with the same or equivalent type recommended by the manufacturer. Dispose of used batteries according to the manufacturer's instructions and your local government's recycling or disposal directives.

Attention:

Il y a un risque d'explosion si la batterie est remplacée de façon incorrecte. Ne la remplacer qu'avec le même modèle ou équivalent recommandé par le constructeur. Recycler les batteries usées en accord avec les instructions du fabricant et les directives gouvernementales de recyclage.

产品中有毒有害物质或元素名称及含量

AAEON System

QO4-381 Rev.A0

部件名称	有毒有害物质或元素					
	铅 (Pb)	汞 (Hg)	镉 (Cd)	六价铬 (Cr(VI))	多溴联苯 (PBB)	多溴二苯 醚(PBDE)
印刷电路板 及其电子组件	×	○	○	○	○	○
外部信号 连接器及线材	×	○	○	○	○	○
外壳	○	○	○	○	○	○
中央处理器 与内存	×	○	○	○	○	○
硬盘	×	○	○	○	○	○
液晶模块	×	×	○	○	○	○
光驱	×	○	○	○	○	○
触控模块	×	○	○	○	○	○
电源	×	○	○	○	○	○
电池	×	○	○	○	○	○

本表格依据 SJ/T 11364 的规定编制。

○：表示该有毒有害物质在该部件所有均质材料中的含量均在 GB/T 26572 标准规定的限量要求以下。

×：表示该有害物质的某一均质材料超出了 GB/T 26572 的限量要求，然而该部件仍符合欧盟指令 2011/65/EU 的规范。

备注：

- 一、此产品所标示之环保使用期限，系指在一般正常使用状况下。
- 二、上述部件物质中央处理器、内存、硬盘、光驱、电源为选购品。
- 三、上述部件物质液晶模块、触控模块仅一体机产品适用。

Hazardous and Toxic Materials List

AAEON System

QO4-381 Rev.A0

Component Name	Hazardous or Toxic Materials or Elements					
	Lead (Pb)	Mercury (Hg)	Cadmium (Cd)	Hexavalent Chromium (Cr(VI))	Polybrominated biphenyls (PBBS)	Polybrominated diphenyl ethers (PBDES)
PCB and Components	X	O	O	O	O	O
Wires & Connectors for Ext.Connections	X	O	O	O	O	O
Chassis	O	O	O	O	O	O
CPU & RAM	X	O	O	O	O	O
HDD Drive	X	O	O	O	O	O
LCD Module	X	X	O	O	O	O
Optical Drive	X	O	O	O	O	O
Touch Control Module	X	O	O	O	O	O
PSU	X	O	O	O	O	O
Battery	X	O	O	O	O	O

This form is prepared in compliance with the provisions of SJ/T 11364.

O: The level of toxic or hazardous materials present in this component and its parts is below the limit specified by GB/T 26572.

X: The level of toxic of hazardous materials present in the component exceed the limits specified by GB/T 26572, but is still in compliance with EU Directive 2011/65/EU (RoHS 2).

Notes:

1. The Environment Friendly Use Period indicated by labelling on this product is applicable only to use under normal conditions.
2. Individual components including the CPU, RAM/memory, HDD, optical drive, and PSU are optional.
3. LCD Module and Touch Control Module only applies to certain products which feature these components.

Table of Contents

Chapter 1 - Product Specifications	1
1.1 Specifications	2
1.2 Product Notice	4
Chapter 2 – Hardware Information	5
2.1 Dimensions	6
2.2 Jumpers and Connectors.....	7
2.3 List of Jumpers	8
2.3.1 Setting Jumpers	8
2.3.2 AT/ATX Mode Select (CN15 Pins 7-8).....	9
2.3.3 PCIe/mSATA Select (JP5).....	9
2.4 List of Connectors.....	10
2.4.1 LAN RJ45 Port (CN1).....	11
2.4.2 HDMI Out Connector (CN2).....	12
2.4.3 HDMI In Connector (CN3).....	13
2.4.4 RTC Battery Connector (CN7).....	13
2.4.5 M.2 2230 E-Key (CN10).....	14
2.4.6 Jetson Xavier NX CPU Module Connector (CN14).....	15
2.4.7 Front Panel Connector (CN15).....	17
2.4.8 Micro USB 2.0 for Flash Image (CN16).....	17
2.4.9 UART Debug Port Connector (CN18).....	18
2.4.10 USB 3.0 Connector (CN19/20).....	18
2.4.11 DC Power In Connector (CN22).....	19
2.4.12 RS-232/RS-485/CANBus Connector (CN23).....	19
2.4.13 External DIO Connector (CN24).....	20
2.4.14 SATA Connector with 5V Power (CN26).....	21
2.4.15 Mini PCIe Connector (PCIE1).....	22

2.4.16	RS-232/485 Select (SW4).....	23
2.5	Hardware Assembly	24
2.5.1	2.5" SATA Drive Installation.....	24
2.5.2	Expansion Card Installation	26
2.5.3	SIM Card Installation.....	27
Chapter 3	– OS Flash Guide.....	28
3.1	Before Installation.....	29
3.2	Connecting to PC/Force Recovery Mode	30
3.3	Flash Image to Board.....	31

Chapter 1

Product Specifications

1.1 Specifications

System

AI Accelerator	NVIDIA® Jetson Xavier™ NX
CPU	6 Core ARM® Carmel® V8.2 64-bit CPU 6MB L2 + 4MB L3
System Memory	8GB LPDDR4x
Storage Device	eMMC 16 GB microSD slot x 1 Full-Size mSATA slot x 1 (sharing slot with Full-Size Mini Card module) 2.5" SATA drive bay x 1
Display Interface	HDMI 2.0 (Type A) x 1
Ethernet	RJ-45 GbE PoE/PSE (802.3at) x 2 RJ-45 GbE LAN x 1
I/O	USB3.2 Gen 1 (Type A) x 4 USB Micro A/B x 1 for OS Flash RJ-45 GbE PoE/PSE (802.3at) x 2 (total 60W) RJ-45 GbE LAN x 1 DB-9 x 1 (RS232/485 and CANbus) DB-15 Digital I/O 13- Channel (programmable) x 1 Recovery Button x 1 microSD card slot x 1 Antenna opening x 4 HDMI 2.0 (Type A) output x 1 HDMI 1.4 (Type A) input x 1 Power Button x 1

System

Expansion	Full-Sized Mini Card slot x 1 (PCIe/USB/mSATA) M.2 E-Key 2230 x 1 (for Wi-Fi) SIM socket x 1 SATA III (6.0 Gbps) port x 1 for 2.5" drive
Indicator	Power LED x 1
OS Support	Linux (AAEON ACLinux 4.9) Linux (NVIDIA JetPack 4.5)

Power Supply

Power Requirement	12 ~ 24V DC with 2-pin terminal block
--------------------------	---------------------------------------

Mechanical

Mounting	Wall-mount
Dimensions (W x D x H)	7.09" x 5.35" x 2.41" (180.0 mm x 136.0 mm x 61.1 mm)
Gross Weight	4.63 lbs. (2.1 kg)
Net Weight	2.87 lbs. (1.3 kg)

Environmental

Operating Temperature	5°F ~ 131°F (-15°C ~ 55°C with 0.5m/s airflow)
Storage Temperature	-40°F ~ 176°F (-40°C ~ 80°C)
Storage Humidity	5 ~ 95% at 40°C, non-condensing
Anti-Vibration	3.5 Grms/ 5 ~ 500Hz/ operation – eMMC, microSD, or mSATA
Anti-Shock	50G peak acceleration (11 msec. duration, eMMC, MicroSD, or mSATA)
Certification	CE / FCC class A

1.2 Product Notice

Micro-USB: Micro-USB port is ideally for flashing OS image only.

USB ports: USB ports do not support USB DVD ROM because of file system.

USB 3.2 Gen 1: USB 3.2 Gen 1 is the current name for 5Gbps specification, formerly USB 3.0.

LAN Indicator Behavior

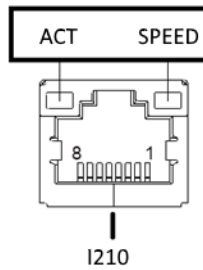

Chapter 2

Hardware Information

2.1 Dimensions

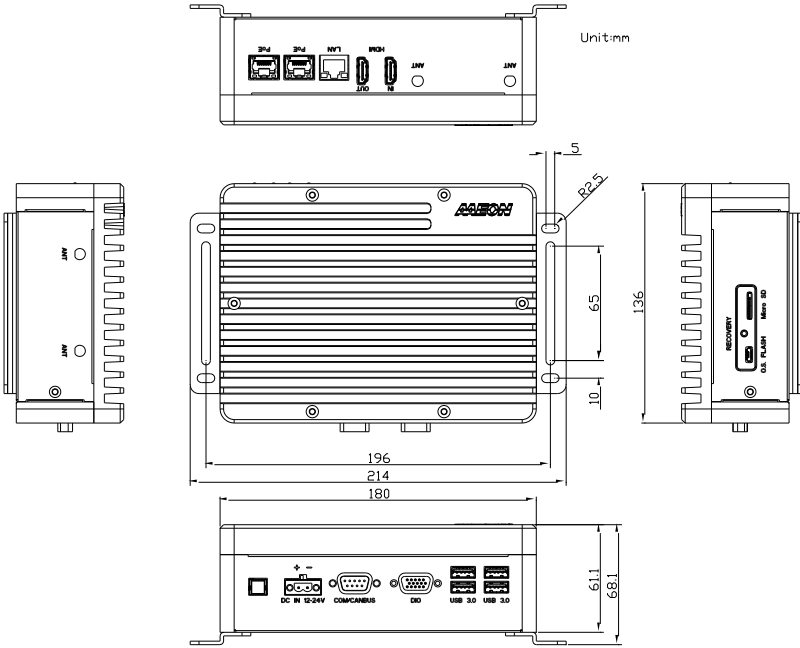

2.2 Jumpers and Connectors

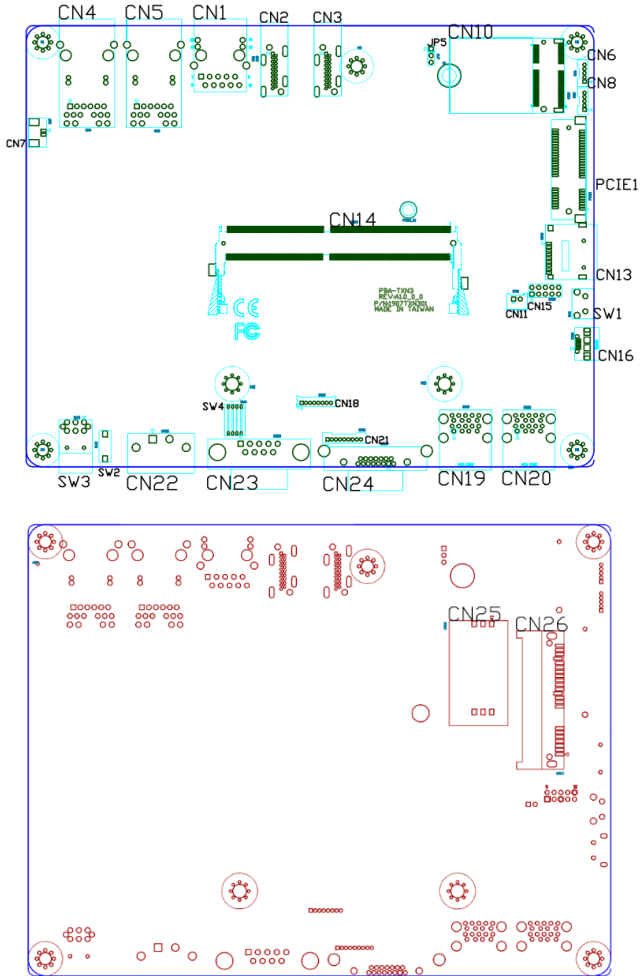

2.3 List of Jumpers

The board has a number of jumpers that allow you to configure your system to suit your application.

The table below shows the function of each of the board's jumpers

Label	Function
CN15 (Pins 7-8)	AT/ATX mode select
JP5	PCIe/mSATA select

2.3.1 Setting Jumpers

You can configure your system to match the needs of your application by setting jumpers. A jumper is the simplest kind of electric switch. It consists of two metal pins and a small metal clip (often protected by a plastic cover) that slides over the pins to connect them. To “close” a jumper you connect the pins with the clip.

To “open” a jumper you remove the clip. Sometimes a jumper will have three pins, labeled 1, 2 and 3. In this case you would connect either pins 1 and 2 or 2 and 3.

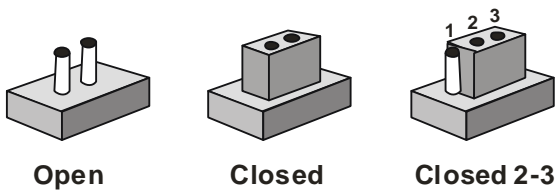

A pair of needle-nose pliers may be helpful when working with jumpers.

If you have any questions about the best hardware configuration for your application, contact your local distributor or sales representative before you make any changes.

Generally, you simply need a standard cable to make most connections.

2.3.2 AT/ATX Mode Select (CN15 Pins 7-8)

The AT/ATX Mode Select functions by connecting pins 7 and 8 of CN15. To prevent damage to the system, do not connect pins 7 and 8 to any other pin.

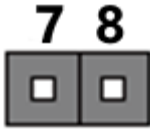

Open – AT Mode

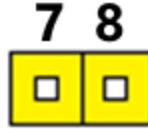

Closed – ATX Mode
(Default)

CN15 pins 7-8	Function
7-8 Open	AT Power Mode
7-8 Closed	ATX Power Mode (Default)

Note: AT Mode is selected when pins 7-8 are open; ATX Mode is selected when pins 7-8 are closed (default setting). If set to ATX Mode, the power button must be used to turn on the system.

2.3.3 PCIe/mSATA Select (JP5)

Pins	Function
1-2	mSATA
2-3	PCIe

2.4 List of Connectors

The board has a number of connectors that allow you to configure your system to suit your application.

The table below shows the function of each of the board's connectors

Label	Function
CN1	Gigabit LAN Connector
CN2	HDMI Out Connector
CN3	HDMI In Connector
CN4	POE Gigabit LAN Connector
CN5	POE Gigabit LAN Connector
CN6	Internal USB 2.0 Connector
CN7	RTC Connector
CN8	Internal USB 2.0 Connector
CN10	M.2 2230 E-Key
CN13	microSD Slot
CN14	Jetson Xavier NX CPU module connector
CN15	Front Panel connector
CN16	Micro USB 2.0 for Flash Image
CN18	UART for Debug/I2C
CN19	USB 3.0 Connector
CN20	USB 3.0 Connector
CN21	Internal DIO Connector
CN22	DC Power In connector
CN23	RS-232/RS-485/CAN BUS Connector
CN24	DIO Connector
CN25	SIM Socket
CN26	SATA Connector with 5V Power

Label	Function
PCIE1	Mini PCIe Slot
SW1	Recovery switch
SW2	Reset switch
SW3	Power switch
SW4	RS-232/RS-485 Select

2.4.1 LAN RJ45 Port (CN1)

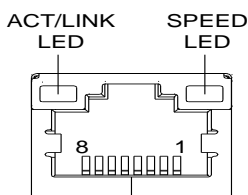

Pin	Signal	Pin	Signal
1	MDI0+	2	MDI0-
3	MDI1+	4	MDI1-
5	MDI2+	6	MDI2-
7	MDI3+	8	MDI3-

2.4.2 HDMI Out Connector (CN2)

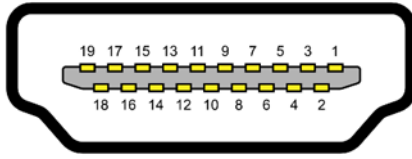

Pin	Signal	Pin	Signal
1	HDMI_DATA2_P	2	GND
3	HDMI_DATA2_N	4	HDMI_DATA1_P
5	GND	6	HDMI_DATA1_N
7	HDMI_DATA0_P	8	GND
9	HDMI_DATA0_N	10	HDMI_CLK_P
11	GND	12	HDMI_CLK_N
13	NC	14	NC
15	HDMI_SCL	16	HDMI_SDA
17	GND	18	HDMI_PWR
19	HDMI_HDP		

2.4.3 HDMI In Connector (CN3)

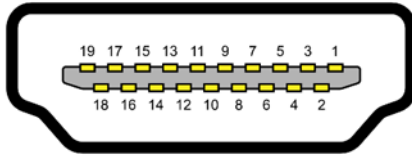

Pin	Signal	Pin	Signal
1	HDMI_DATA2_P	2	GND
3	HDMI_DATA2_N	4	HDMI_DATA1_P
5	GND	6	HDMI_DATA1_N
7	HDMI_DATA0_P	8	GND
9	HDMI_DATA0_N	10	HDMI_CLK_P
11	GND	12	HDMI_CLK_N
13	NC	14	NC
15	HDMI_SCL	16	HDMI_SDA
17	GND	18	HDMI_PWR
19	HDMI_HDP		

2.4.4 RTC Battery Connector (CN7)

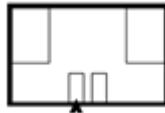

Pin	Signal	Pin	Signal
1	+3V	2	GND

2.4.5 M.2 2230 E-Key (CN10)

		GND	75
74	3.3V	RESERVED/REFCLKn1	73
72	3.3V	RESERVED/REFCLKp1	71
70	UIM_POWER_SRC/GPIO1/PEWAKE1#	GND	69
68	UIM_POWER_SNK/CLKREQ1#	RESERVED/PETn1	67
66	UIM_SWP/PERST1#	RESERVED/PETp1	65
64	RESERVED	GND	63
62	ALERT# (O)(0/3.3V)	RESERVED/PERn1	61
60	I2C_CLK (I)(0/3.3V)	RESERVED/PERp1	59
58	I2C_DATA (I/O)(0/3.3V)	GND	57
56	W_DISABLE1# (I)(0/3.3V)	PEWAKE0# (I/O)(0/3.3V)	55
54	W_DISABLE2# (I)(0/3.3V)	CLKREQ0# (I/O)(0/3.3V)	53
52	PERST0# (I)(0/3.3V)	GND	51
50	SUSCLK(32kHz) (I)(0/3.3V)	REFCLKn0	49
48	COEX1 (I/O)(0/1.8V)	REFCLKp0	47
46	COEX2(I/O)(0/1.8V)	GND	45
44	COEX3(I/O)(0/1.8V)	PETn0	43
42	VENDOR DEFINED	PETp0	41
40	VENDOR DEFINED	GND	39
38	VENDOR DEFINED	PERn0	37
36	UART CTS (I)(0/1.8V)	PERp0	35
34	UART RTS (O)(0/1.8V)	GND	33
32	UART RXD (I)(0/1.8V)	Module Key	
	Module Key	Module Key	
	Module Key	Module Key	
	Module Key	Module Key	
	Module Key	Module Key	
22	UART TXD (O)(0/1.8V)	SDIO RESET# (I)(0/1.8V)	23
20	UART WAKE# (O)(0/3.3V)	SDIO WAKE# (O)(0/1.8V)	21
18	GND	SDIO DATA3(I/O)(0/1.8V)	19
16	LED2# (O)(OD)	SDIO DATA2(I/O)(0/1.8V)	17
14	PCM_IN/I2S SD_IN (I)(0/1.8V)	SDIO DATA1(I/O)(0/1.8V)	15
12	PCM_OUT/I2S SD_OUT (O)(0/1.8V)	SDIO DATA0(I/O)(0/1.8V)	13
10	PCM_SYNC/I2S WS (I/O)(0/1.8V)	SDIO CMD(I/O)(0/1.8V)	11
8	PCM_CLK/I2S SCK (I/O)(0/1.8V)	SDIO CLK(I)(0/1.8V)	9
6	LED1# (O)(OD)	GND	7
4	3.3V	USB_D-	5
2	3.3V	USB_D+	3
		GND	1

2.4.6 Jetson Xavier NX CPU Module Connector (CN14)

Module Signal Name	Pin #	Pin #	Module Signal Name
GND	1	2	GND
CSI1_D0_N	3	4	CSI0_D0_N
CSI1_D0_P	5	6	CSI0_D0_P
GND	7	8	GND
CSI1_CLK_N	9	10	CSI0_CLK_N
CSI1_CLK_P	11	12	CSI0_CLK_P
GND	13	14	GND
CSI1_D1_N	15	16	CSI0_D1_N
CSI1_D1_P	17	18	CSI0_D1_P
GND	19	20	GND
CSI3_D0_N	21	22	CSI2_D0_N
CSI3_D0_P	23	24	CSI2_D0_P
GND	25	26	GND
CSI3_CLK_N	27	28	CSI2_CLK_N
CSI3_CLK_P	29	30	CSI2_CLK_P
GND	31	32	GND
CSI3_D1_N	33	34	CSI2_D1_N
CSI3_D1_P	35	36	CSI2_D1_P
GND	37	38	GND
DP0_TXD0_N	39	40	CSI4_D2_N
DP0_TXD0_P	41	42	CSI4_D2_P
GND	43	44	GND
DP0_TXD1_N	45	46	CSI4_D0_N
DP0_TXD1_P	47	48	CSI4_D0_P
GND	49	50	GND
DP0_TXD2_N	51	52	CSI4_CLK_N
DP0_TXD2_P	53	54	CSI4_CLK_P
GND	55	56	GND
DP0_TXD3_N	57	58	CSI4_D1_N
DP0_TXD3_P	59	60	CSI4_D1_P
GND	61	62	GND
DP1_TXD0_N	63	64	CSI4_D3_N
DP1_TXD0_P	65	66	CSI4_D3_P
GND	67	68	GND
DP1_TXD1_N	69	70	DS1_D0_N
DP1_TXD1_P	71	72	DS1_D0_P
GND	73	74	GND

Module Signal Name	Pin #	Pin #	Module Signal Name
PCIE0_RX0_P	133	134	PCIE0_TX0_N
GND	135	136	PCIE0_TX0_P
PCIE0_RX1_N	137	138	GND
PCIE0_RX1_P	139	140	PCIE0_TX1_N
GND	141	142	PCIE0_TX1_P
CAN_RX	143	144	GND
KEY	KEY	KEY	KEY
CAN_TX	145	146	GND
GND	147	148	PCIE0_TX2_N
PCIE0_RX2_N	149	150	PCIE0_TX2_P
PCIE0_RX2_P	151	152	GND
GND	153	154	PCIE0_TX3_N
PCIE0_RX3_N	155	156	PCIE0_TX3_P
PCIE0_RX3_P	157	158	GND
GND	159	160	PCIE0_CLK_N
USBSS_RX_N	161	162	PCIE0_CLK_P
USBSS_RX_P	163	164	GND
GND	165	166	USBSS_TX_N
PCIE1_RX0_N	167	168	USBSS_TX_P
PCIE1_RX0_P	169	170	GND
GND	171	172	PCIE1_TX0_N
PCIE1_CLK_N	173	174	PCIE1_TX0_P
PCIE1_CLK_P	175	176	GND
GND	177	178	MOD_SLEEP*
PCIE_WAKE*	179	180	PCIE0_CLKREQ*
PCIE0_RST*	181	182	PCIE1_CLKREQ*
PCIE1_RST*	183	184	GBE_MDIO_N
I2C0_SCL	185	186	GBE_MDIO_P
I2C0_SDA	187	188	GBE_LED_LINK
I2C1_SCL	189	190	GBE_MDI1_N
I2C1_SDA	191	192	GBE_MDI1_P
I2S0_DOUT	193	194	GBE_LED_ACT
I2S0_DIN	195	196	GBE_MDI2_N
I2S0_FS	197	198	GBE_MDI2_P
I2S0_SCLK	199	200	GND
GND	201	202	GBE_MDI3_N
UART1_TXD	203	204	GBE_MDI3_P

Module Signal Name	Pin #	Pin #	Module Signal Name
DP1_TXD2_N	75	76	DSI_CLK_N
DP1_TXD2_P	77	78	DSI_CLK_P
GND	79	80	GND
DP1_TXD3_N	81	82	DSI_D1_N
DP1_TXD3_P	83	84	DSI_D1_P
GND	85	86	GND
GPIO00	87	88	DP0_HPD
SPI0_MOSI	89	90	DP0_AUX_N
SPI0_SCK	91	92	DP0_AUX_P
SPI0_MISO	93	94	HDMI_CEC
SPI0_CS0*	95	96	DPI_HPD
SPI0_CS1*	97	98	DPI_AUX_N
UART0_TXD	99	100	DP1_AUX_P
UART0_RXD	101	102	GND
UART0_RTS*	103	104	SPI1_MOSI
UART0_CTS*	105	106	SPI1_SCK
GND	107	108	SPI1_MISO
USB0_D_N	109	110	SPI1_CS0*
USB0_D_P	111	112	SPI1_CS1*
GND	113	114	CAM0_PWDN
USB1_D_N	115	116	CAM0_MCLK
USB1_D_P	117	118	GPIO01
GND	119	120	CAM1_PWDN
USB2_D_N	121	122	CAM1_MCLK
USB2_D_P	123	124	GPIO02
GND	125	126	GPIO03
GPIO04	127	128	GPIO05
GND	129	130	GPIO06
PCIe0_RXD_N	131	132	GND

Legend

Ground	Power
--------	-------

Module Signal Name	Pin #	Pin #	Module Signal Name
UART1_RXD	205	206	GPIO07
UART1_RTS*	207	208	GPIO08
UART1_CTS*	209	210	CLK_32K_OUT
GPIO09	211	212	GPIO10
CAM_I2C_SCL	213	214	FORCE_RECOVERY*
CAM_I2C_SDA	215	216	GPIO11
GND	217	218	GPIO12
SDMMC_DAT0	219	220	I2S1_DOUT
SDMMC_DAT1	221	222	I2S1_DIN
SDMMC_DAT2	223	224	I2S1_FS
SDMMC_DAT3	225	226	I2S1_SCLK
SDMMC_CMD	227	228	GPIO13
SDMMC_CLK	229	230	GPIO14
GND	231	232	I2C2_SCL
SHUTDOWN_REQ*	233	234	I2C2_SDA
PMIC_BBAT	235	236	UART2_TXD
POWER_EN	237	238	UART2_RXD
SYS_RESET*	239	240	SLEEP/WAKE*
GND	241	242	GND
GND	243	244	GND
GND	245	246	GND
GND	247	248	GND
GND	249	250	GND
VDD_IN	251	252	VDD_IN
VDD_IN	253	254	VDD_IN
VDD_IN	255	256	VDD_IN
VDD_IN	257	258	VDD_IN
VDD_IN	259	260	VDD_IN

2.4.7 Front Panel Connector (CN15)

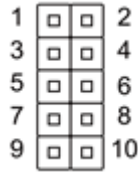

Pin	Signal	Pin	Signal
1	Power Button	2	GND
3	Recovery	4	GND
5	Reset	6	GND
7	Latch Set	8	Latch Set
9	PWR LED	10	+5V

Note: Pins 7-8 are used for setting AT/ATX Mode and Auto Power. See Ch 2.3.2 for details.

2.4.8 Micro USB 2.0 for Flash Image (CN16)

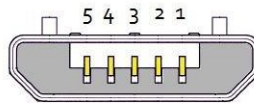

USB Micro-B

Pin	Signal	Pin	Signal
1		2	USB1-
3	USB1+	4	
5	GND		

2.4.9 UART Debug Port Connector (CN18)

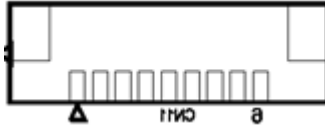

Pin	Signal	Pin	Signal
1	3.3V	2	UART0 TXD
3	UART0 RXD	4	GND
5		6	I2C SCL
7	I2C SDA	8	GND

2.4.10 USB 3.0 Connector (CN19/20)

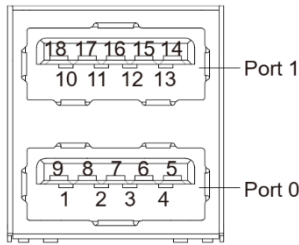

Pin	Signal	Pin	Signal
U1	VBUS_1	U10	VBUS_2
U2	(A)D-	U11	(B)D-
U3	(A)D+	U12	(B)D+
U4	GND	U13	GND
U5	(A)SSRX-	U14	(B)SSRX-
U6	(A)SSRX+	U15	(B)SSRX+
U7	GND	U16	GND
U8	(A)SSTX-	U17	(B)SSTX-
U9	(A)SSTX+	U18	(B)SSTX+

2.4.11 DC Power In Connector (CN22)

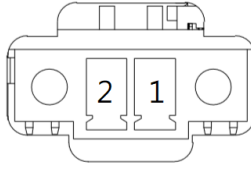

Pin	Signal	Pin	Signal
1	PWR IN	2	GND

2.4.12 RS-232/RS-485/CANBus Connector (CN23)

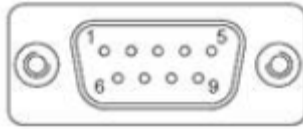

Pin	RS-232	RS-422	RS-485
1		TX-	RA-
2	RXD	TX+	RA+
3	TXD	RX+	
4		RX-	
5	GND		
6			
7	CAN0 L	CAN0 L	CAN0 L
8	CAN0 H	CAN0 H	CAN0 H
9			

Note: RS-232/422/485 mode is controlled by SW4. See Ch 2.4.31 for setting details.

2.4.13 External DIO Connector (CN24)

Pin	Signal	Pin	SYSFS GPIO
1	+3.3V	1	Power
2	37P_SPI1_MOSI_LS	2	GPIO482
3	22P_SPI1_MISO_LS	3	GPIO481
4	13P_SPI1_SCK_LS	4	GPIO480
5	18P_SPI1_CS0_LS	5	GPIO483
6	19P_SPI0_MOSI_LS	6	GPIO493
7	21P_SPI0_MISO_LS	7	GPIO492
8	23P_SPI0_SCK_LS	8	GPIO491
9	24P_SPI0_CS0_LS	9	GPIO494
10	26P_SPI0_CS1_LS	10	GPIO495
11	35P_I2S0_LRCK_LS	11	GPIO448
12	38P_I2S0_SDIN_LS	12	GPIO447
13	40P_I2S0_SDOOUT_LS	13	GPIO446
14	12P_I2S0_SCLK_LS	14	GPIO445
15	GND	15	GND

2.4.14 SATA Connector with 5V Power (CN26)

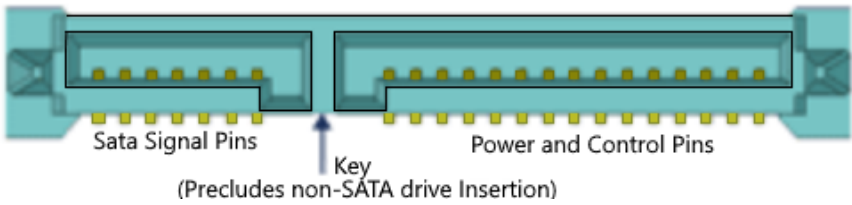

Pin	SATA Signal Pins	Pin	Power Pins
1	GND	1	NC
2	TX+	2	NC
3	TX-	3	NC
4	GND	4	GND
5	RX+	5	GND
6	RX-	6	GND
7	GND	7	+5V
		8	+5V
		9	+5V
		10	GND
		11	NC
		12	GND
		13	NC
		14	NC
		15	NC

2.4.15 Mini PCIe Connector (PCIE1)

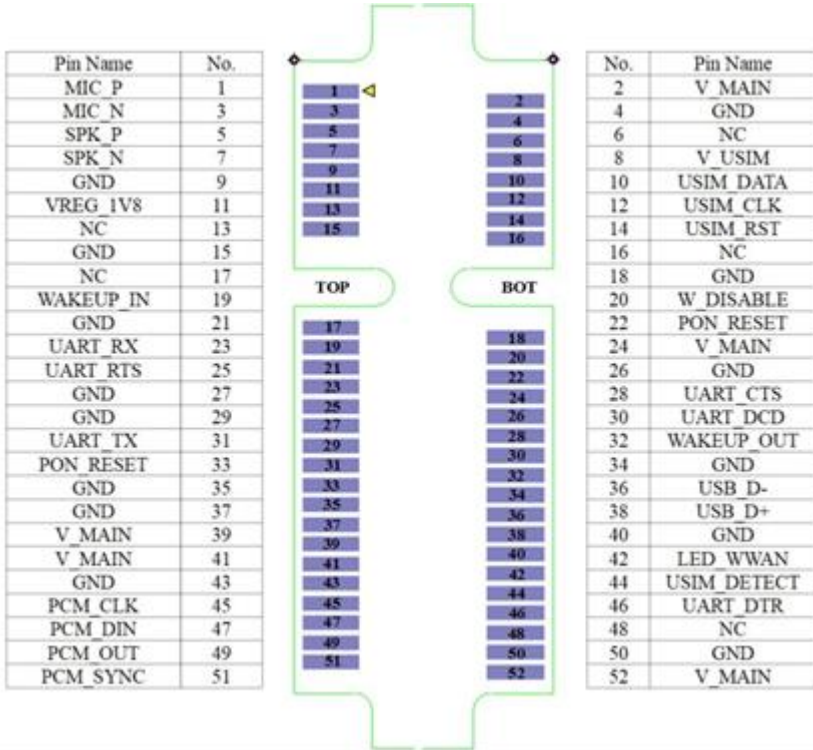

2.4.16 RS-232/485 Select (SW4)



Mode	S-1	S-2	S-3	S-4
1T/1R RS-232	On	On		
1T/1R RS-422	On	Off		
1T/1R RS-485	Off	On		
Low Power Shutdown	Off	Off		
Enable RS-422/RS-485 bias and termination resistors			On	
Disable RS-422/RS-485 bias and termination resistors			Off	
250kbps for RS-232 and RS-485/RS-422				On
RS-232 3Mbps RS-485/RS-422 20Mbps				Off

Note: SW4 controls the RS-232/422/485 mode for CN23. See Ch 2.4.23 for Pin Definitions

2.5 Hardware Assembly

This section details the hardware assembly steps for the BOXER-8253AI. Please read this section thoroughly before beginning installation and ensure you have all necessary components ready. A Phillips head screwdriver is required.

2.5.1 2.5" SATA Drive Installation

Step 1: Open the 2.5" Drive panel by removing the screw

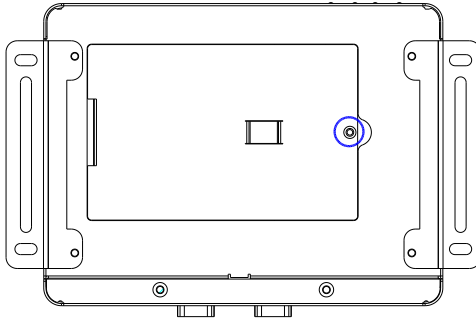

Step 2: Place the 2.5" Drive into the drive cage. Secure with four screws.

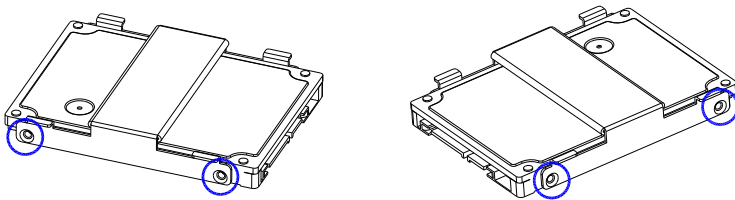

Step 3: Place the drive assembly into the system, followed by pasting the thermal pad, as shown:

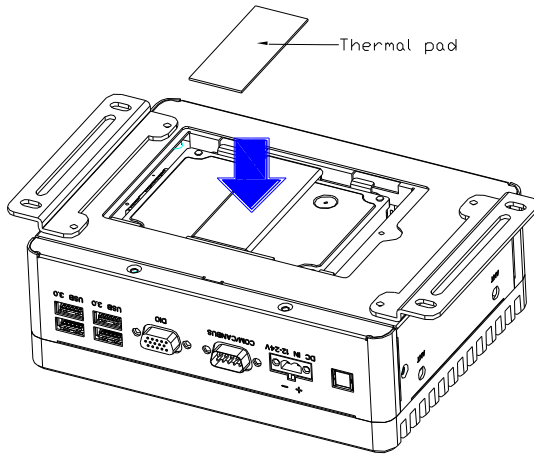

Note: Thermal pad is used to affix SSD.

Step 4: Reattach and secure the bottom panel.

2.5.2 Expansion Card Installation

Step 1: Remove the top chassis cover by unscrewing the six screws as shown:

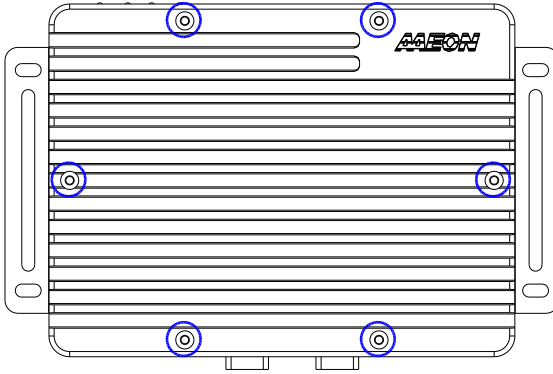

Step 2: Locate the M.2 and Mini-Card slots as shown. Follow standard procedures for installing expansion cards. Note the location of the mounting screws.

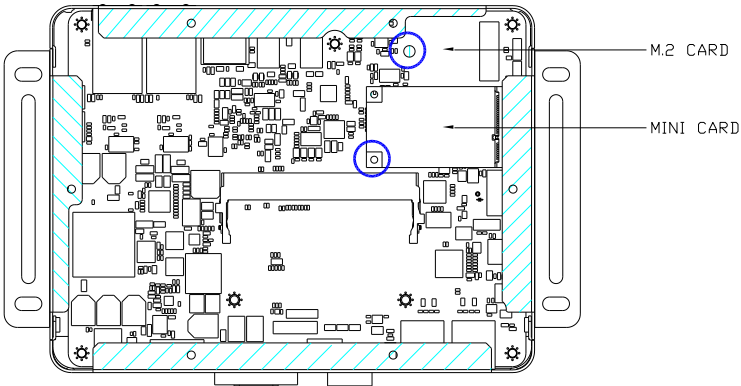

2.5.3 SIM Card Installation

Step 1: Remove the bottom panel as in Ch 2.5.1. The SIM Card Slot is located on the board. If you have a 2.5" drive installed you will need to remove the assembly to install the SIM card.

Step 2: Open the SIM card holder as shown.

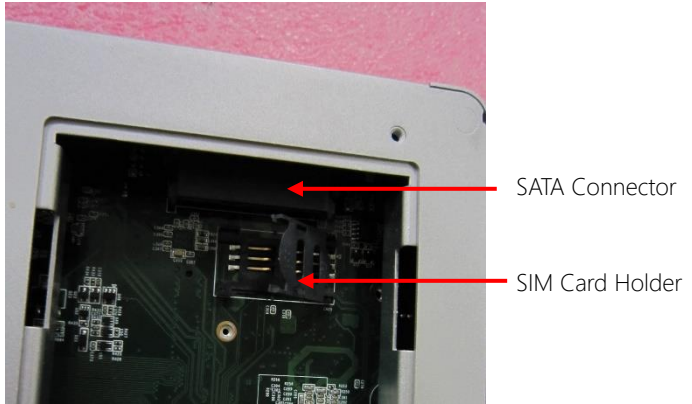

Step 3: Slide the SIM card into the holder, then gently press down to secure in place.

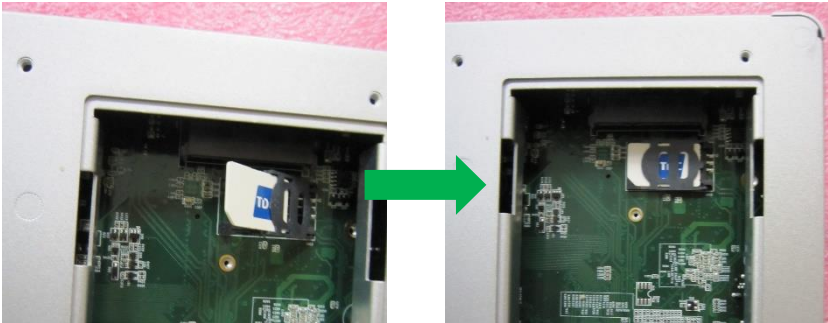

Chapter 3

OS Flash Guide

3.1 Before Installation

Before starting the process make sure your BOXER-8253AI system is turned off and the power in is disconnected. You will need a host PC running Ubuntu 16.04 or 18.04, and make sure the NVIDIA Jetson Xavier NX module is installed onto the BOXER-8253AI carrier board/ system.

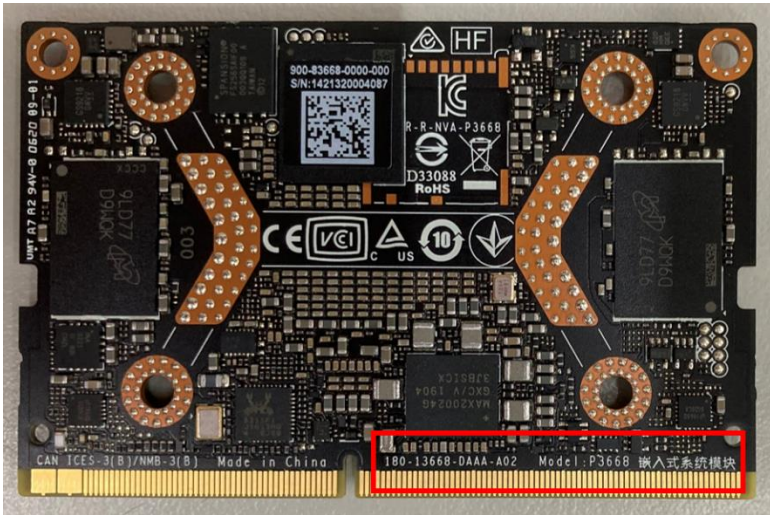

Download the compressed OS image file. The file name will follow the format of:

ACLinux_4.9_{OS_IF}_{PLF_IF}_{PJ_IF}_{BN}.tar.gz

For example:

ACLinux_4.9_ACLNX49D.NV05.BOXER-8253AI.2.tar.gz

Note: Filename may differ from this example.

- I. **{OS_IF}** is OS Information. For example, **ACLNX49D** means ACLinux 4.9, Desktop version.
- II. **{PLF_IF}** is Platform Information; e.g. **NV05**
- III. **{PJ_IF}** is Project Information; e.g. **BOXER-8253AI**
- IV. **{BN}** is Build Number; e.g. 0, 1, 2, etc.

3.2 Connecting to PC/Force Recovery Mode

On Host Computer, open Linux terminal and enter the following command to extract compressed OS image files (*file name may vary*):

```
$ tar -zxvf ACLinux_4.9_ACLNX49D.NV05.BOXER-8253AI.2.tar.gz
```

Next, perform the following steps to force the system to start in USB Recovery Mode:

1. Connect the Micro-USB plug on the USB cable to the Recovery Port on the BOXER-8253AI and the other end to an available USB port on the host PC.
2. Connect the BOXER-8253AI power supply.
3. Press and hold the recovery key button. While holding the recovery key button, power on the system, and continue to hold the recovery key button for two seconds, then release. The BOXER-8253AI should enter recovery mode.
4. To check if device is in recovery mode, enter `lsusb` command in terminal on host.

```
$ lsusb | grep 0955:7e19
```

If successful, the command will return **"0955:7e19 Nvidia Corp"**

```
~/ACLinux_4.9_ACLNX49D.NV05.BOXER-8253AI.4/bootloader $ lsusb | grep 0955:7e19  
Bus 003 Device 059: ID 0955:7e19 NVidia Corp.
```

Recovery mode can be initiated with the system disassembled. Ensure the NVIDIA Jetson Xavier NX module is installed and refer to the image below to perform the steps:

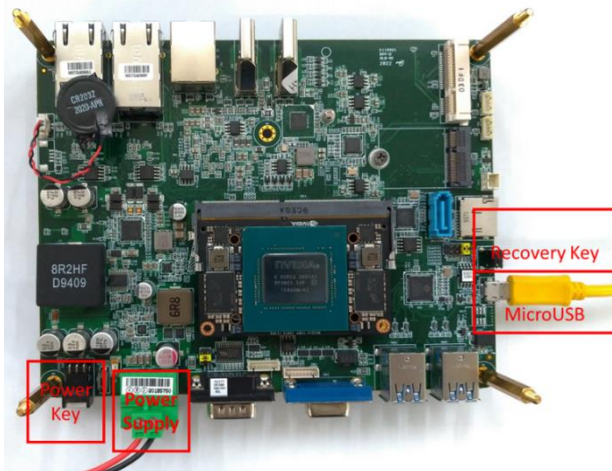

3.3 Flash Image to Board

Use the following steps to flash the OS to the BOXER-8253AI.

- 1) Open terminal on Ubuntu host PC, then access the bootloader folder you extracted in the previous section.
- 2) Enter the following command in terminal to flash the image:

```
$ sudo ./flashall.sh
```

```
~/ACLinux_4.9_ACLNX49D.NV05.BOXER-8253AI.4/bootloader $ sudo ./flashall.sh
[sudo] password for marble:
Welcome to Tegra Flash
version 1.0.0
Type ? or help for help and q or quit to exit
Use ! to execute system commands

[ 0.0180 ] tegrasign_v2 --key None --getmode mode.txt
[ 0.0199 ] Assuming zero filled SBK key
[ 0.0400 ]
[ 0.0401 ] Generating RCM messages
[ 0.0514 ] tegrahost_v2 --chip 0x19 0 --magicid MB1B --appendsigheader mb1_t194_prod.bin zerosbk
[ 0.0529 ] Header already present for mb1_t194_prod.bin
[ 0.0681 ]
[ 0.0697 ] tegrasign_v2 --key None --getmode mode.txt
[ 0.0709 ] Assuming zero filled SBK key
```

- 3) Wait as the image is installed. Once finished you should see the following:

```
[ 769.0397 ] tegradevflash_v2 --write BCT br_bct_BR.bct
[ 769.0411 ] Bootloader version 01.00.0000
[ 769.0429 ] Writing partition BCT with br_bct_BR.bct
[ 769.0432 ] [.....] 100%
[ 769.2029 ]
[ 769.2466 ] tegradevflash_v2 --write MB1_BCT mb1_cold_boot_bct_MB1_sigheader.bct.encrypt
[ 769.2479 ] Bootloader version 01.00.0000
[ 769.2497 ] Writing partition MB1_BCT with mb1_cold_boot_bct_MB1_sigheader.bct.encrypt
[ 769.2503 ] [.....] 100%
[ 769.4621 ]
[ 769.4648 ] tegradevflash_v2 --write MB1_BCT_b mb1_cold_boot_bct_MB1_sigheader.bct.encrypt
[ 769.4668 ] Bootloader version 01.00.0000
[ 769.4692 ] Writing partition MB1_BCT_b with mb1_cold_boot_bct_MB1_sigheader.bct.encrypt
[ 769.4704 ] [.....] 100%
[ 769.6735 ]
[ 769.6885 ] tegradevflash_v2 --write MEM_BCT mem_coldboot_sigheader.bct.encrypt
[ 769.6899 ] Bootloader version 01.00.0000
[ 769.6919 ] Writing partition MEM_BCT with mem_coldboot_sigheader.bct.encrypt
[ 769.6924 ] [.....] 100%
[ 770.9723 ]
[ 770.9751 ] tegradevflash_v2 --write MEM_BCT_b mem_coldboot_sigheader.bct.encrypt
[ 770.9774 ] Bootloader version 01.00.0000
[ 770.9799 ] Writing partition MEM_BCT_b with mem_coldboot_sigheader.bct.encrypt
[ 770.9813 ] [.....] 100%
[ 772.2408 ]
[ 772.2409 ] Flashing completed

[ 772.2410 ] Coldbooting the device
[ 772.2442 ] tegrarcm_v2 --ismb2
[ 772.2483 ]
[ 772.2506 ] tegradevflash_v2 --reboot coldboot
[ 772.2527 ] Bootloader version 01.00.0000
[ 772.2702 ]
~/ACLinux_4.9_ACLNX49D.NV05.BOXER-8253AI.4/bootloader $
```