

BOXER-8221AI

Compact Fanless Embedded AI@Edge Box PC
with NVIDIA[®] Jetson Nano[™]
User's Manual 5th Ed

Copyright Notice

This document is copyrighted, 2025. All rights are reserved. The original manufacturer reserves the right to make improvements to the products described in this manual at any time without notice.

No part of this manual may be reproduced, copied, translated, or transmitted in any form or by any means without the prior written permission of the original manufacturer. Information provided in this manual is intended to be accurate and reliable. However, the original manufacturer assumes no responsibility for its use, or for any infringements upon the rights of third parties that may result from its use.

The material in this document is for product information only and is subject to change without notice. While reasonable efforts have been made in the preparation of this document to assure its accuracy, AAEMON assumes no liabilities resulting from errors or omissions in this document, or from the use of the information contained herein.

AAEMON reserves the right to make changes in the product design without notice to its users.

Acknowledgements

All other products' name or trademarks are properties of their respective owners.

- NVIDIA, the NVIDIA logo, and Jetson are trademarks of the NVIDIA Corporation
- ITE is a trademark of Integrated Technology Express, Inc.
- IBM and VGA are trademarks of International Business Machines Corporation.
- Ubuntu is a registered trademark of Canonical

All other product names or trademarks are properties of their respective owners. No ownership is implied or assumed for products, names or trademarks not herein listed by the publisher of this document.

Packing List

Before setting up your product, please make sure the following items have been shipped:

Item	Quantity
● BOXER-8221AI	1
● Wall mount bracket	2
● Power Connector	1

If any of these items are missing or damaged, please contact your distributor or sales representative immediately.

About this Document

This User's Manual contains all the essential information, such as detailed descriptions and explanations on the product's hardware and software features (if any), its specifications, dimensions, jumper/connector settings/definitions, and driver installation instructions (if any), to facilitate users in setting up their product.

Users may refer to the product page at AAEON.com for the latest version of this document.

Safety Precautions

Please read the following safety instructions carefully. It is advised that you keep this manual for future references

1. All cautions and warnings on the device should be noted.
2. All cables and adapters supplied by AAEON are certified and in accordance with the material safety laws and regulations of the country of sale. Do not use any cables or adapters not supplied by AAEON to prevent system malfunction or fires.
3. Make sure the power source matches the power rating of the device.
4. Position the power cord so that people cannot step on it. Do not place anything over the power cord.
5. Always completely disconnect the power before working on the system's hardware.
6. No connections should be made when the system is powered as a sudden rush of power may damage sensitive electronic components.
7. If the device is not to be used for a long time, disconnect it from the power supply to avoid damage by transient over-voltage.
8. Always disconnect this device from any AC supply before cleaning.
9. While cleaning, use a damp cloth instead of liquid or spray detergents.
10. Make sure the device is installed near a power outlet and is easily accessible.
11. Keep this device away from humidity.
12. Place the device on a solid surface during installation to prevent falls
13. Do not cover the openings on the device to ensure optimal heat dissipation.
14. Watch out for high temperatures when the system is running.
15. Do not touch the heat sink or heat spreader when the system is running
16. Never pour any liquid into the openings. This could cause fire or electric shock.

17. As most electronic components are sensitive to static electrical charge, be sure to ground yourself to prevent static charge when installing the internal components. Use a grounding wrist strap and contain all electronic components in any static-shielded containers.
18. If any of the following situations arises, please the contact our service personnel:
 - i. Damaged power cord or plug
 - ii. Liquid intrusion to the device
 - iii. Exposure to moisture
 - iv. Device is not working as expected or in a manner as described in this manual
 - v. The device is dropped or damaged
 - vi. Any obvious signs of damage displayed on the device
19. **DO NOT LEAVE THIS DEVICE IN AN UNCONTROLLED ENVIRONMENT WITH TEMPERATURES BEYOND THE DEVICE'S PERMITTED STORAGE TEMPERATURES (SEE CHAPTER 1) TO PREVENT DAMAGE.**

FCC Statement

Warning!



This device complies with Part 15 FCC Rules. Operation is subject to the following two conditions: (1) this device may not cause harmful interference, and (2) this device must accept any interference received including interference that may cause undesired operation.

Caution:

There is a danger of explosion if the battery is incorrectly replaced. Replace only with the same or equivalent type recommended by the manufacturer. Dispose of used batteries according to the manufacturer's instructions and your local government's recycling or disposal directives.

Attention:

Il y a un risque d'explosion si la batterie est remplacée de façon incorrecte. Ne la remplacer qu'avec le même modèle ou équivalent recommandé par le constructeur. Recycler les batteries usées en accord avec les instructions du fabricant et les directives gouvernementales de recyclage.

China RoHS Requirements (CN)

产品中有毒有害物质或元素名称及含量

AAEON System

QQ4-381 Rev.A2

部件名称	有毒有害物质或元素					
	铅 (Pb)	汞 (Hg)	镉 (Cd)	六价铬 (Cr(VI))	多溴联苯 (PBB)	多溴二苯醚 (PBDE)
印刷电路板 及其电子组件	×	○	○	○	○	○
外部信号 连接器及线材	×	○	○	○	○	○
外壳	○	○	○	○	○	○
中央处理器 与内存	×	○	○	○	○	○
硬盘	×	○	○	○	○	○
液晶模块	×	○	○	○	○	○
光驱	×	○	○	○	○	○
触控模块	×	○	○	○	○	○
电源	×	○	○	○	○	○
电池	×	○	○	○	○	○

本表格依据 SJ/T 11364 的规定编制。

○：表示该有毒有害物质在该部件所有均质材料中的含量均在 GB/T 26572 标准规定的限量要求以下。

×：表示该有害物质的某一均质材料超出了 GB/T 26572 的限量要求，然而该部件仍符合欧盟指令 2011/65/EU 的规范。

环保使用期限(EFUP (Environmental Friendly Use Period))：10 年

备注：

一、此产品所标示之环保使用期限，系指在一般正常使用状况下。

二、上述部件物质中央处理器、内存、硬盘、光驱、电源为选购品。

三、上述部件物质液晶模块、触控模块仅一体机产品适用。

China RoHS Requirement (EN)

Name and content of hazardous substances in product

AAEON System

QO4-381 Rev.A2

Part Name	Hazardous Substances					
	铅 (Pb)	汞 (Hg)	镉 (Cd)	六价铬 (Cr(VI))	多溴联苯 (PBB)	多溴二苯醚 (PBDE)
PCB Assemblies	×	○	○	○	○	○
Connector and Cable	×	○	○	○	○	○
Chassis	○	○	○	○	○	○
CPU and Memory	×	○	○	○	○	○
Hard Disk	×	○	○	○	○	○
LCD Modules	×	○	○	○	○	○
CD-ROM/DVD-ROM	×	○	○	○	○	○
Touch Modules	×	○	○	○	○	○
Power	×	○	○	○	○	○
Battery	×	○	○	○	○	○

The table is prepared in accordance with the provisions of SJ/T 11364.

○ : Indicates that said hazardous substance contained in all of the homogenous materials for this product is below the limit requirement of GB/T 26572.

× : Indicates that said hazardous substance contained in at least one of the homogenous materials used for this part is above the limit requirement of GB/T 26572. But this product still be compliance with 2011/65/EU Directive (allowed with 2011/65/EU Annex III of RoHS exemption with number 6(c),7(a),7(c)-1).

EFUP (Environment Friendly Use Period) value: 10 years.

Notes:

1. This product defined period of use is under normal condition.
2. In above part, CPU/Memory/ Hard Disk/CD-ROM/DVD-ROM/ Power are optional.
3. In above part, LCD Modules/ Touch Modules are for all-in-one product model.

Table of Contents

Chapter 1 - Product Specifications	1
1.1 Specifications	2
1.2 Product Notice	4
Chapter 2 – Hardware Information	5
2.1 Dimensions	6
2.2 Jumpers and connectors.....	7
2.3 List of Jumpers	9
2.3.1 Setting Jumpers	9
2.3.2 AT/ATX Mode Select (CN1 Pins 7-8)	10
2.4 List of Connectors.....	11
2.4.1 Front Panel Connector (CN1)	12
2.4.2 DC Power In Connector (CN2)	12
2.4.3 USB 2.0 Connector for Flash Image (CN3)	13
2.4.4 LAN RJ45 Port (CN4).....	13
2.4.5 HDMI Connector (CN5)	14
2.4.6 Dual USB 3.2 Gen 1 Connector (CN6/CN7)	15
2.4.7 RTC Battery Connector (CN8).....	15
2.4.8 COM Port Connector (CN9/CN10)	16
2.4.9 COM Port Connector (System).....	17
2.4.10 Jetson Nano CPU Module Connector (CN12).....	18
2.4.11 UART Debug Port Connector (CN15).....	19
2.5 Hardware Assembly	20
Chapter 3 – OS Flash guide	22
3.1 Introduction	23
3.1.1 Verifying Your Jetson Nano Module	25
3.2 Flash to microSD Card.....	26

3.2.1	Before You Begin	27
3.2.3	Flash Image to microSD Card	28
3.3	Flash to System	32
3.3.1	Before Installation	32
3.3.2	Connecting to PC/ Force Recovery Mode	34
3.3.3	Flash Image to Board	35

Chapter 1

Product Specifications

1.1 Specifications

System

AI Accelerator	NVIDIA® Jetson Nano™
CPU	Quad Core ARM® Cortex® -A57 MPCore Processor
System Memory	4GB LPDDR4
Storage Device	32GB microSD (A version) or 16GB eMMC (B version)
Display Interface	HDMI 2.0
Ethernet	10/100/1000Base-TX x 1
I/O	USB3.2 Gen 1 x 4 LAN x 1 RS-232 x 2 HDMI x 1 MicroSD x 1 DC Power Input x 1 Recovery Button x 1 Micro-USB for Flash OS x 1
Expansion	M.2 E-Key 2230 x 1 (for Wi-Fi)
Indicator	Power LED x 1
OS Support	Linux (AAEON ACLinux 4.9) Linux (NVIDIA Jetpack 4.5)

Power Supply

Power Requirement	12Vdc w/ 2-pin terminal block
-------------------	-------------------------------

Mechanical

Mounting	Wallmount
Dimensions (W x D x H)	3.46" x 2.95" x 1.53" (88 mm x 75 mm x 39 mm)
Gross Weight	1.10 lbs. (0.5 kg)
Net Weight	0.66 lbs. (0.3 kg)

Environmental

Operating Temperature	-4°F ~ 122°F (-20°C ~ 50°C, according to IEC60068-2 with 0.5 m/s airflow)
Storage Temperature	-49°F ~ 176°F (-45°C ~ 80°C)
Storage Humidity	95% @ 40°C, non-condensing
Anti-Vibration	3 Grms/ 5 ~ 500Hz/ operation – microSD or eMMC
Certification	CE/FCC class A

1.2 Product Notice

Micro-USB: Micro-USB port is ideally for flashing image only.

USB ports: USB ports do not support USB DVD ROM because of file system.

USB 3.2 Gen 1: USB 3.2 Gen 1 is the current name for 5Gbps specification, formerly USB 3.0.

LAN Indicator Behavior

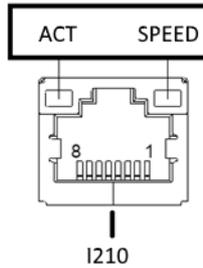

Chapter 2

Hardware Information

2.1 Dimensions

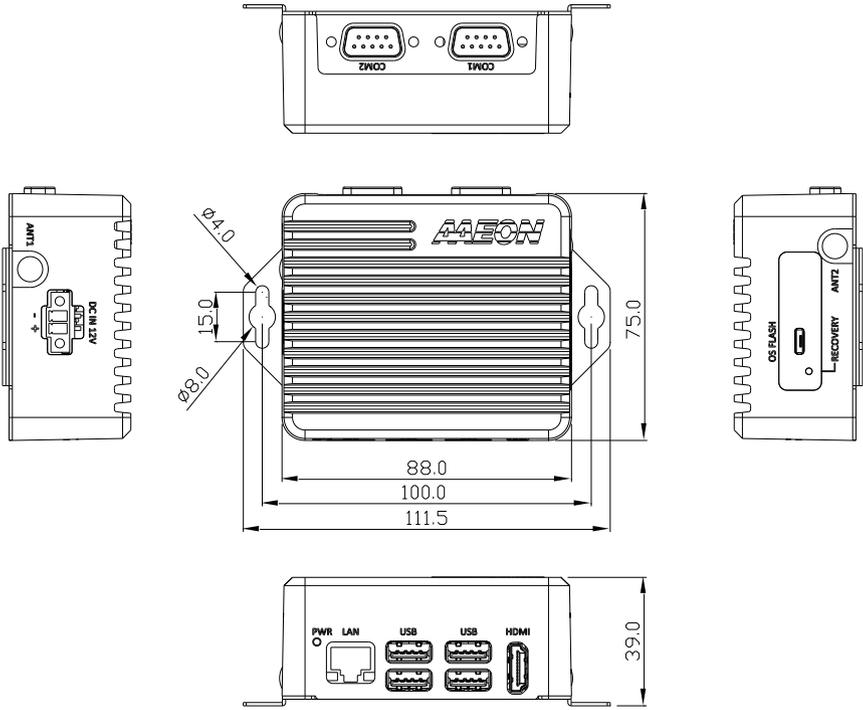

2.2 Jumpers and connectors

Component Side

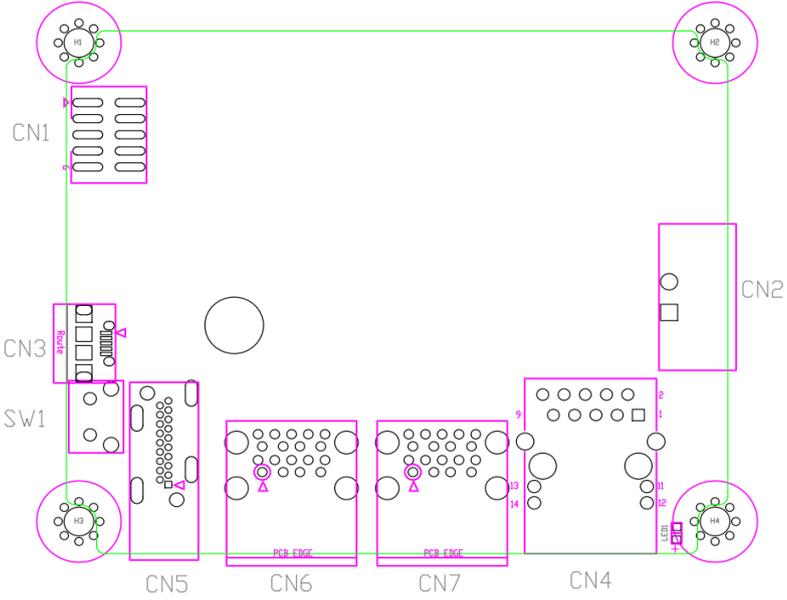

Module Side

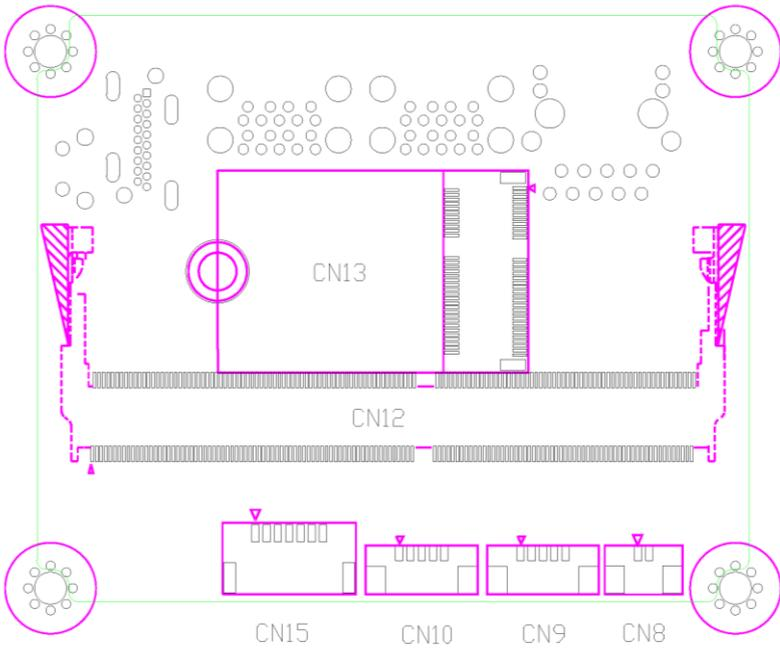

2.3 List of Jumpers

The board has a number of jumpers that allow you to configure your system to suit your application.

The table below shows the function of each of the board's jumpers

Label	Function
CN1 (Pin 7-8)	AT/ATX mode select

2.3.1 Setting Jumpers

You can configure your system to match the needs of your application by setting jumpers. A jumper is the simplest kind of electric switch. It consists of two metal pins and a small metal clip (often protected by a plastic cover) that slides over the pins to connect them. To “close” a jumper you connect the pins with the clip.

To “open” a jumper you remove the clip. Sometimes a jumper will have three pins, labeled 1, 2 and 3. In this case you would connect either pins 1 and 2 or 2 and 3.

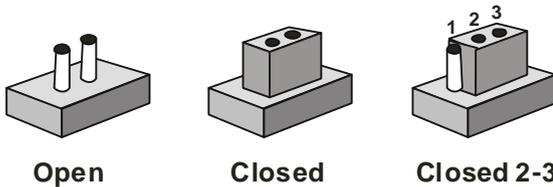

A pair of needle-nose pliers may be helpful when working with jumpers.

If you have any questions about the best hardware configuration for your application, contact your local distributor or sales representative before you make any changes.

Generally, you simply need a standard cable to make most connections.

2.3.2 AT/ATX Mode Select (CN1 Pins 7-8)

The AT/ATX Mode Select functions by connecting pins 7 and 8 of CN1. To prevent damage to the system, do not connect pins 7 and 8 to any other pin.



Open – AT Mode
(Default)

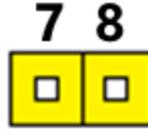

Closed – ATX Mode

CN1 pins 7-8	Function
7-8 Open	AT Power Mode (Default)
7-8 Closed	ATX Power Mode

2.4 List of Connectors

The board has a number of connectors that allow you to configure your system to suit your application.

The table below shows the function of each of the board's connectors

Label	Function
CN1	Front Panel Connector
CN2	DC Power In connector
CN3	Micro USB for Flash image
CN4	Giga LAN Connector
CN5	HDMI Connector
CN6	Dual USB 3.2 Gen 1 Connector
CN7	Dual USB 3.2 Gen 1 Connector
CN8	RTC Connector
CN9	COM1 Connector /dev/ttyTHS1
CN10	COM2 Connector /dev/ttyTHS2
CN12	Jetson NANO CPU module connector
CN13	M.2 E key
CN15	UART for Debug
SW1	Recovery switch

Note: USB 3.2 Gen 1 uses the same specifications as USB 3.0 (transfer rate 5Gbs).

2.4.1 Front Panel Connector (CN1)

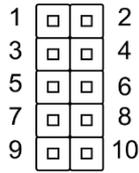

Pin	Signal	Pin	Signal
1	Button power	2	GND
3	Recovery	4	GND
5	Reset	6	GND
7	Latch set	8	Latch set
9	PWR LED	10	+5V

Note: Pin 7 and 8 are used for setting AT/ATX Power Mode. See [Chapter 2.3.2](#) for information. To prevent damage to your system, do not connect Pins 7 and 8 with any other pin.

2.4.2 DC Power In Connector (CN2)

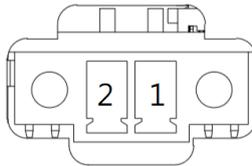

Pin	Signal	Pin	Signal
1	PWR_IN	2	GND

2.4.3 USB 2.0 Connector for Flash Image (CN3)

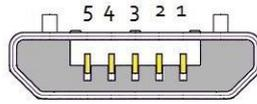

USB Micro-B

Pin	Signal	Pin	Signal
1		2	USB1-
3	USB1+	4	
5	GND		

2.4.4 LAN RJ45 Port (CN4)

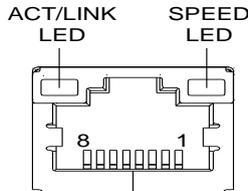

Pin	Signal	Pin	Signal
1	MDI0+	2	MDI0-
3	MDI1+	4	MDI1-
5	MDI2+	6	MDI2-
7	MDI3+	8	MDI3-

2.4.5 HDMI Connector (CN5)

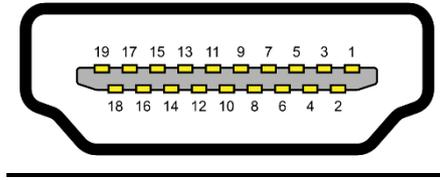

Pin	Signal	Pin	Signal
1	HDMI_DATA2_P	2	GND
3	HDMI_DATA2_N	4	HDMI_DATA1_P
5	GND	6	HDMI_DATA1_N
7	HDMI_DATA0_P	8	GND
9	HDMI_DATA0_N	10	HDMI_CLK_P
11	GND	12	HDMI_CLK_N
13	NC	14	NC
15	HDMI_SCL	16	HDMI_SDA
17	GND	18	HDMI_PWR
19	HDMI_HDP		

2.4.6 Dual USB 3.2 Gen 1 Connector (CN6/CN7)

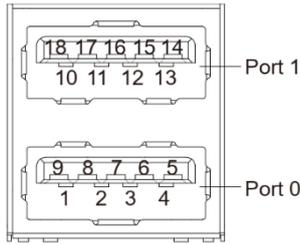

Pin	Signal	Pin	Signal
U1	VBUS_1	U10	VBUS_2
U2	(A)D-	U11	(B)D-
U3	(A)D+	U12	(B)D+
U4	GND	U13	GND
U5	(A)SSRX-	U14	(B)SSRX-
U6	(A)SSRX+	U15	(B)SSRX+
U7	GND	U16	GND
U8	(A)SSTX-	U17	(B)SSTX-
U9	(A)SSTX+	U18	(B)SSTX+

2.4.7 RTC Battery Connector (CN8)

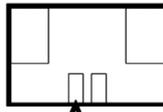

Pin	Signal	Pin	Signal
1	+3V	2	GND

2.4.8 COM Port Connector (CN9/CN10)

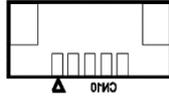

Pin	RS-232	UART (3.3V)
1	TXD	
2	RXD	
3		UART TXD
4		UART RXD
5	GND	
6		
7		
8		
9		

Label	System Reference
COM1	/dev/ttyTHS1
COM2	/dev/ttyTHS2

2.4.9 COM Port Connector (System)

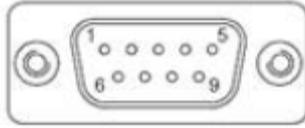

Pin	RS-232	UART (3.3V)
1		
2	RXD	
3	TXD	
4		
5	GND	
6		
7		UART RXD
8		UART TXD
9		

2.4.10 Jetson Nano CPU Module Connector (CN12)

Signal Name	Pin # Top Odd	Pin # Bottom Even	Signal Name
GND	1	2	GND
CSI1_D0_N	3	4	CSI0_D0_N
CSI1_D0_P	5	6	CSI0_D0_P
GND	7	8	GND
RSVD	9	10	CSI0_CLK_N
RSVD	11	12	CSI0_CLK_P
GND	13	14	GND
CSI1_D1_N	15	16	CSI0_D1_N
CSI1_D1_P	17	18	CSI0_D1_P
GND	19	20	GND
CSI3_D0_N	21	22	CSI2_D0_N
CSI3_D0_P	23	24	CSI2_D0_P
GND	25	26	GND
CSI3_CLK_N	27	28	CSI2_CLK_N
CSI3_CLK_P	29	30	CSI2_CLK_P
GND	31	32	GND
CSI3_D1_N	33	34	CSI2_D1_N
CSI3_D1_P	36	36	CSI2_D1_P
GND	37	38	GND
DP0_TXD0_N	39	40	CSI4_D2_N
DP0_TXD0_P	41	42	CSI4_D2_P
GND	43	44	GND
DP0_TXD1_N	45	46	CSI4_D0_N
DP0_TXD1_P	47	48	CSI4_D0_P
GND	49	50	GND
DP0_TXD2_N	51	52	CSI4_CLK_N
DP0_TXD2_P	53	54	CSI4_CLK_P
GND	55	56	GND
DP0_TXD3_N	57	58	CSI4_D1_N
DP0_TXD3_P	59	60	CSI4_D1_P
GND	61	62	GND
DP1_TXD0_N	63	64	CSI4_D3_N
DP1_TXD0_P	65	66	CSI4_D3_P
GND	67	68	GND
DP1_TXD1_N	69	70	DSI_D0_N
DP1_TXD1_P	71	72	DSI_D0_P
GND	73	74	GND
DP1_TXD2_N	75	76	DSI_CLK_N
DP1_TXD2_P	77	78	DSI_CLK_P
GND	79	80	GND
DP1_TXD3_N	81	82	DSI_D1_N
DP1_TXD3_P	83	84	DSI_D1_P
GND	85	86	GND
GPIO0	87	88	DP0_HPD
SPID_MOSI	89	90	DP0_AUX_N
SPID_SCK	91	92	DP0_AUX_P
SPID_MISO	93	94	HDMI_CEC
SPID_CS0*	95	96	DP1_HPD
SPID_CS1*	97	98	DP1_AUX_N
UART0_TXD	99	100	DP1_AUX_P
UART0_RXD	101	102	GND
UART0_RTS*	103	104	SP1_MCSI
UART0_CTS*	105	106	SP1_SCK
GND	107	108	SP1_MISO
USB0_D_N	109	110	SP1_CS0*
USB0_D_P	111	112	SP1_CS1*
GND	113	114	CAM0_PWDN
USB1_D_N	115	116	CAM0_MCLK
USB1_D_P	117	118	GPIO01
GND	119	120	CAM1_PWDN
USB2_D_N	121	122	CAM1_MCLK
USB2_D_P	123	124	GPIO02
GND	125	126	GPIO03
GPIO04	127	128	GPIO05
GND	129	130	GPIO06
PCIEX_RX0_N	131	132	GND

Signal Name	Pin # Top Odd	Pin # Bottom Even	Signal Name
PCIEX_RX0_P	133	134	PCIEX_TX0_N
GND	135	136	PCIEX_TX0_P
PCIEX_RX1_N	137	138	GND
PCIEX_RX1_P	139	140	PCIEX_TX1_N
GND	141	142	PCIEX_TX1_P
RSVD	143	144	GND
KEY	KEY	KEY	KEY
RSVD	145	146	GND
GND	147	148	PCIEX_TX2_N
PCIEX_RX2_N	149	150	PCIEX_TX2_P
PCIEX_RX2_P	151	152	GND
GND	153	154	PCIEX_TX3_N
PCIEX_RX3_N	155	156	PCIEX_TX3_P
PCIEX_RX3_P	157	158	GND
GND	159	160	PCIEX_CLK_N
USBSS_RX_N	161	162	PCIEX_CLK_P
USBSS_RX_P	163	164	GND
GND	165	166	USBSS_TX_N
RSVD	167	168	USBSS_TX_P
RSVD	169	170	GND
GND	171	172	RSVD
RSVD	173	174	RSVD
RSVD	175	176	GND
GND	177	178	MCD_SLEEP*
PCIE_WAKE*	179	180	PCIE_CLKREQ*
PCIEX_RST*	181	182	RSVD
RSVD	183	184	GBE_MDIO_N
IC20_SCL	185	186	GBE_MDIO_P
IC20_SDA	187	188	GBE_LED_LINK
IC21_SCL	189	190	GBE_MDIO_N
IC21_SDA	191	192	GBE_MDIO_P
IC20_DOUT	193	194	GBE_LED_ACT
IC20_DIN	195	196	GBE_MDIO_N
IC20_FS	197	198	GBE_MDIO_P
IC20_SCLK	199	200	GND
GND	201	202	GBE_MDIO_N
UART1_TXD	203	204	GBE_MDIO_P
UART1_RXD	205	206	GPIO07
UART1_RTS*	207	208	GPIO08
UART1_CTS*	209	210	CLK_33K_OUT
GPIO09	211	212	GPIO10
CAM_IC2C_SCL	213	214	FORCE_RECOVERY*
CAM_IC2C_SDA	215	216	GPIO11
GND	217	218	GPIO12
SDMMC_DAT0	219	220	IC21_DOUT
SDMMC_DAT1	221	222	IC21_DIN
SDMMC_DAT2	223	224	IC21_FS
SDMMC_DAT3	225	226	IC21_SCLK
SDMMC_CMD	227	228	GPIO13
SDMMC_CLK	229	230	GPIO14
GND	231	232	IC22_SCL
SHUTDOWN_REQ*	233	234	IC22_SDA
PMIC_BBAT	235	236	UART2_TXD
POWER_EN	237	238	UART2_RXD
SYS_RESET*	239	240	SLEEPWAKE*
GND	241	242	GND
GND	243	244	GND
GND	245	246	GND
GND	247	248	GND
GND	249	250	GND
VDD_IN	251	252	VDD_IN
VDD_IN	253	254	VDD_IN
VDD_IN	255	256	VDD_IN
VDD_IN	257	258	VDD_IN
VDD_IN	259	260	VDD_IN

2.4.11 UART Debug Port Connector (CN15)

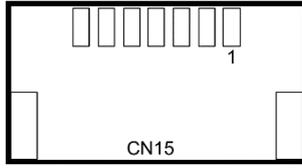

Pin	
1	3.3V
2	UART0 TXD
3	UART0 RXD
4	GND
5	I2C SCL
6	I2C SDA
7	GND

2.5 Hardware Assembly

Chassis Assembly

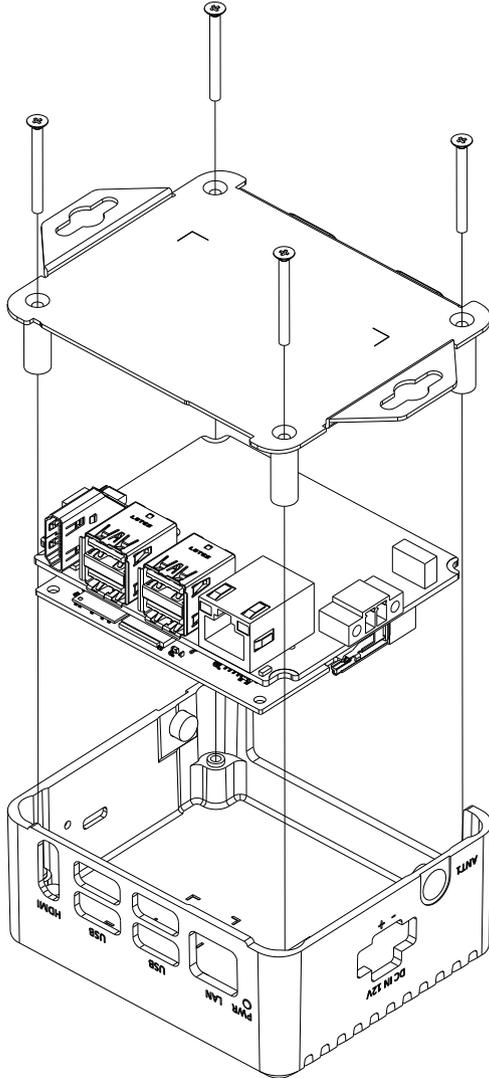

Micro-SD Installation

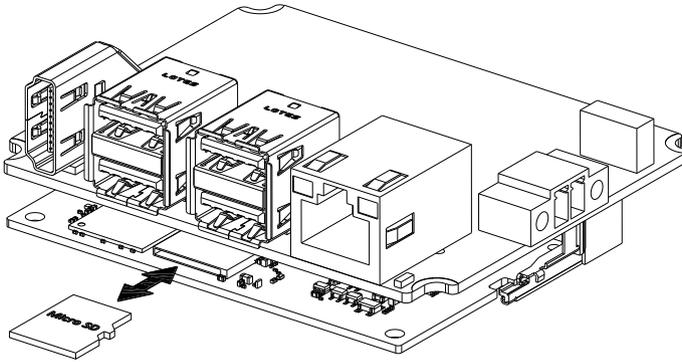

Micro-SD card installs directly onto NVIDIA Jetson Nano module. Check diagram for correct orientation before inserting card.

M.2 Module Installation

M.2 module attaches to the BOXER-8221AI board. NVIDIA Jetson Nano module must be removed prior to installing M.2 module.



Chapter 3

OS Flash guide

3.1 Introduction

This chapter details the steps to flash the Linux operating system to your BOXER-8221AI system with NVIDIA Jetson Nano. The instructions are divided into two parts depending 1) the NVIDIA JetPack version included with your Linux OS image and 2) whether your Jetson Nano has onboard eMMC storage or SD Card slot.

Jetson Nano module with SD Card slot (no onboard eMMC):

Linux OS with JetPack version prior to 4.5 [Flash to SD Card](#)

Linux OS with JetPack versions 4.5 and later [Flash to System](#)

Jetson Nano module with onboard eMMC (no SD Card slot):

All versions of JetPack [Flash to System](#)

If you are unsure which Jetson Nano module you have, check Ch 3.1.1 Verifying Your Jetson Nano Module.

If you are unsure which image to use, visit the AAEON support page or contact your AAEON representative.

Download the OS Image

Download the OS image from the product page at AAEON.com by clicking the link:

<https://www.aaeon.com/en/p/nvidia-jetson-nano-embedded-box-pc-boxer-8221ai>

Caution: Do Not Update via Terminal

When flashing a Linux operating system, it is common practice to use the commands **sudo apt-get update** and **sudo apt-get upgrade** to ensure you have the latest version available. DO NOT USE THESE COMMANDS with your BOXER-8221AI system.

The images provided on AAEON's website include drivers and software which allows the NVIDIA SoC to recognize the various hardware features of the BOXER-8221AI. Attempting to update via terminal can erase this software and cause your system to be unable to recognize peripherals or I/O ports.

To ensure you have the latest OS image, visit the product page at the link above regularly.

Security Notice WARNING:

Using an image with Boot from External Storage function may carry a security risk, i.e. SD Card or SSD. AAEON cannot guarantee that devices other than eMMC as boot media are able to maintain complete security and scalability, even if Secure Boot is enabled.

3.1.1 Verifying Your Jetson Nano Module

If you are unsure which storage type your Jetson Nano module uses, you can perform a quick visual inspection to see if it has eMMC memory or an SD Card slot.

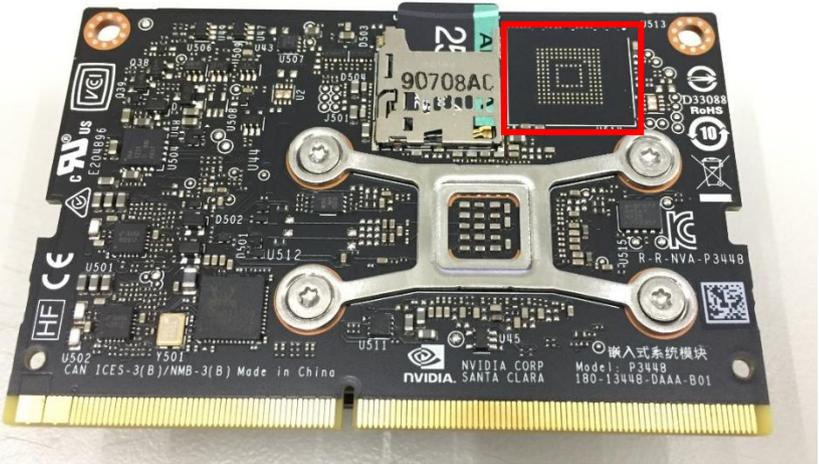

Jetson Nano module with SD Card slot. You can see the SD Card slot easily, as well as the lack of eMMC storage in the highlighted area.

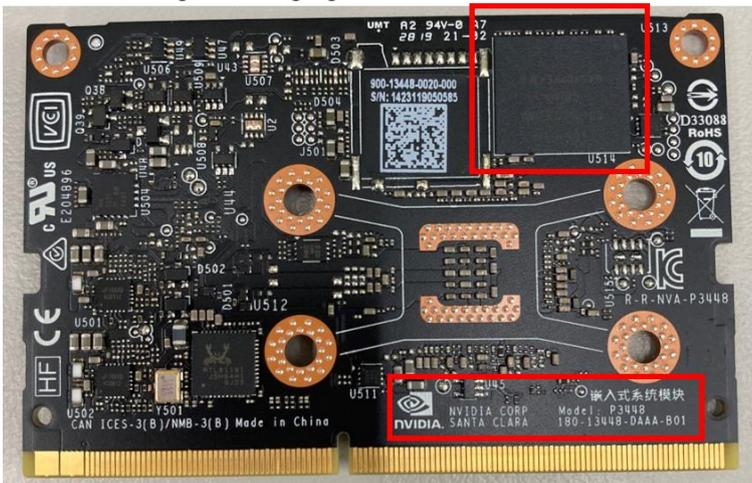

Jetson Nano module with eMMC storage. Note the eMMC module in the highlighted square as well as the missing SD Card slot next to it.

3.2 Flash to microSD Card

This section details the steps to flashing the Linux OS image to a microSD Card for your BOXER-8221AI NVIDIA Jetson Nano system.

Note: This section is only applicable to installing images with JetPack versions prior to 4.5 onto Jetson Nano modules with onboard microSD Card slot (no eMMC). Read the previous section to determine if this is applicable to your system.

The steps outlined apply to ACLinux build 3 or later. To identify the build number, check the file name of the download. It should be formatted as follows, with {BN} being the build number.

ACLinux_4.9_ACLNX49D.NV03.BOXER-8221AI.{BN}.tar.gz

For example, build number 4 will be named as:

ACLinux_4.9_ACLNX49D.NV03.BOXER-8221AI.4.tar.gz

If you have any questions or are unsure which build number you have, or need help installing an older build, please contact AAEON support or ask your AAEON representative for assistance.

3.2.1 Before You Begin

Before beginning the process ensure you have the following:

- ACLinux Image Build 3 or later
- One host PC with operating system Ubuntu 16.04 or 18.04
- microSD Card 16GB or larger
- microSD Card USB adapter/reader (if host PC does not have a microSD Slot)
- Jetson Nano Development Kit B01 module (no onboard eMMC storage); see image below for reference

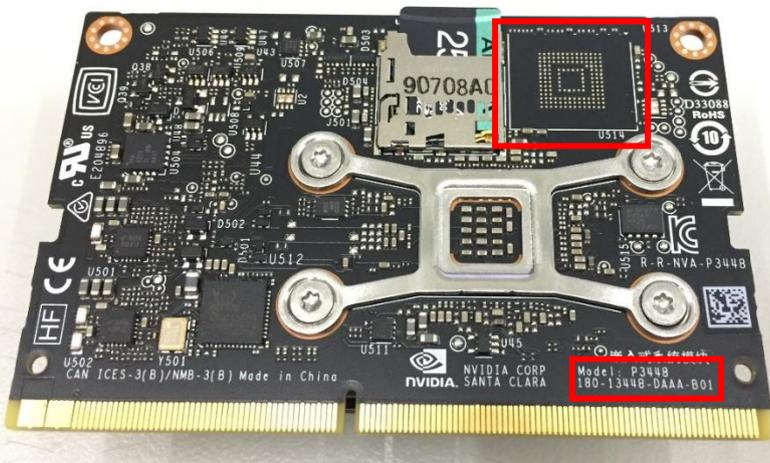

AAEON recommends downloading balenaEtcher for the image flash process. You can download Etcher from the balena website: <https://www.balena.io/etcher/>

Finally, before starting, on the Linux host PC, extract the image file you downloaded using the following command in terminal (remember to replace {BN} with the actual build number in the file name):

```
$ tar xzf ACLinux_4.9_ACLNX49D.NV03.BOXER-8221AI.{BN}.tar.gz
```

3.2.3 Flash Image to microSD Card

Step 1: Insert the microSD card you want to flash into the host PC.

Step 2: Run the Etcher flash tool.

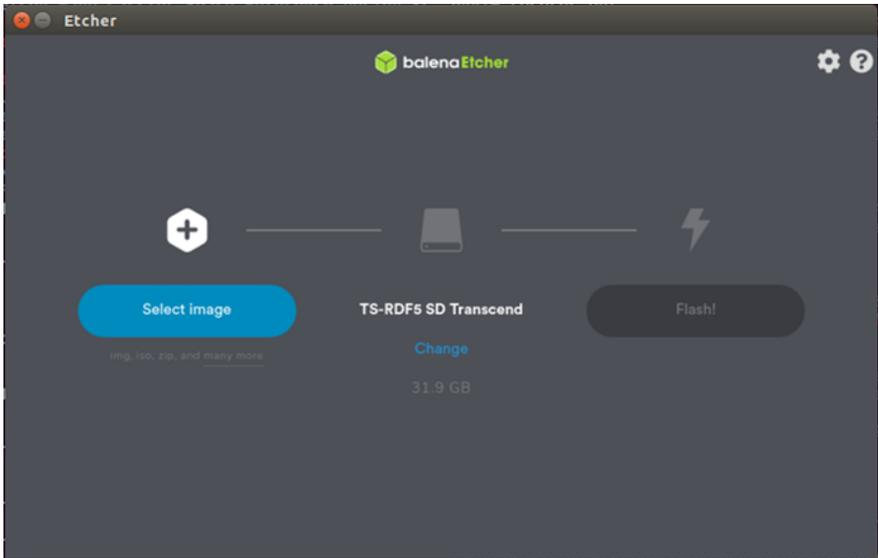

Step 3: Click “Select image” and choose the image file you extracted. File name should look like:

ACLlinux_4.9_ACLNX49D.NV03.BOXER-8221AI.{BN}.sd.img

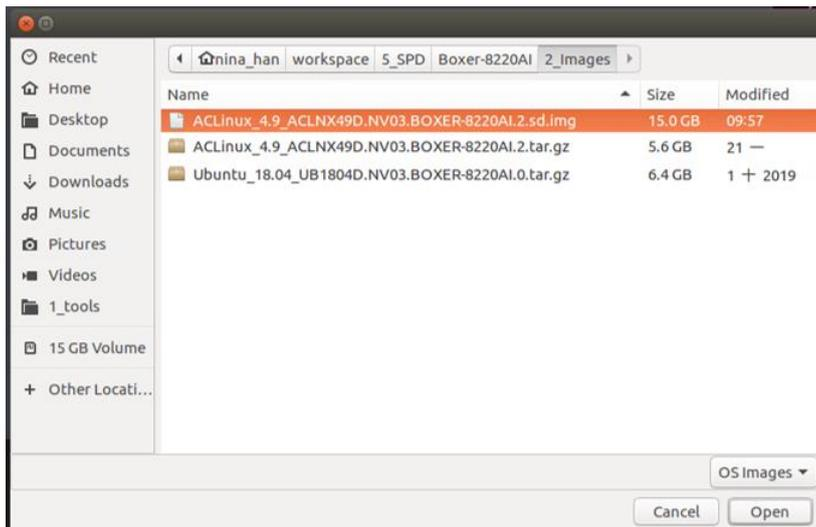

Step 4: Etcher will automatically choose a USB device to write to. Click “Change” to select the correct device if Etcher has not defaulted to the SD Card.

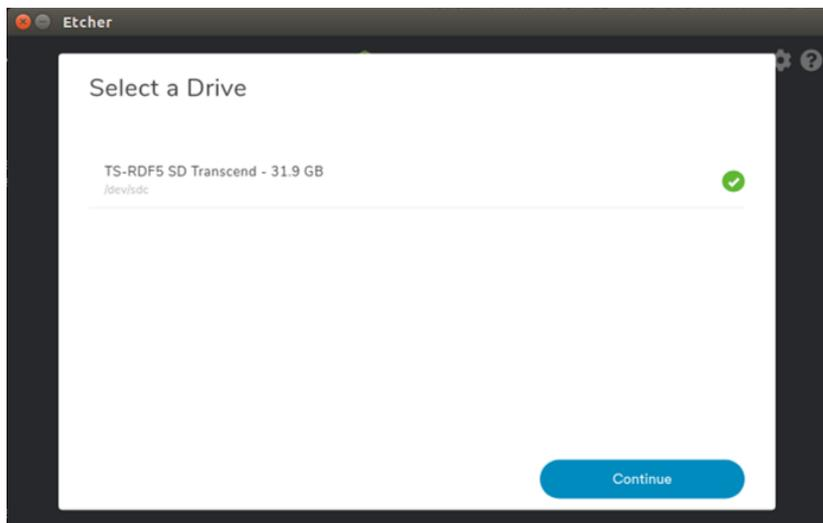

Step 5: Click "Flash!" to flash image to your SD Card. Ubuntu may ask for a password to continue the operation. Enter your password to continue.

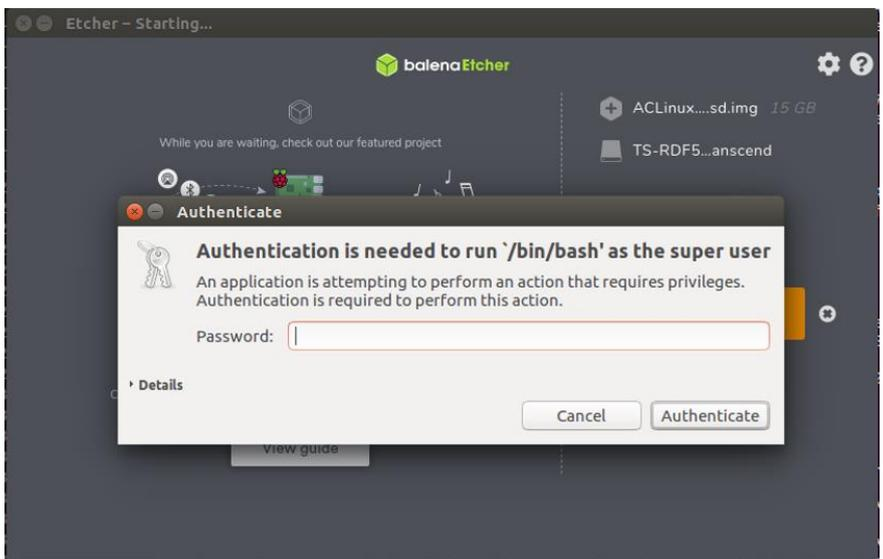

Step 6: Wait for Etcher to complete the process.

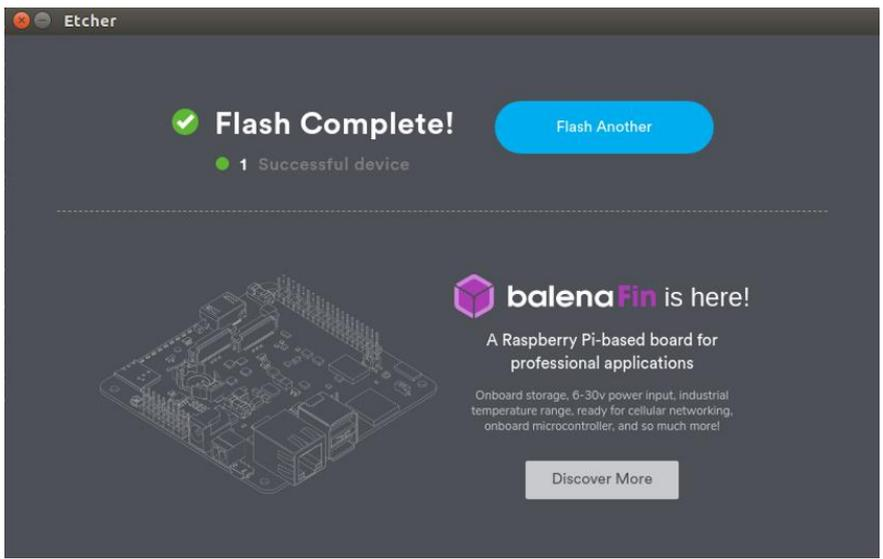

Step 7: After Etcher successfully finishes, remove the microSD Card from the host PC, insert the microSD card into the NVIDIA Jetson Nano SOC, then insert the Jetson Nano SOC into the BOXER-8221AI board if you have not already done so.

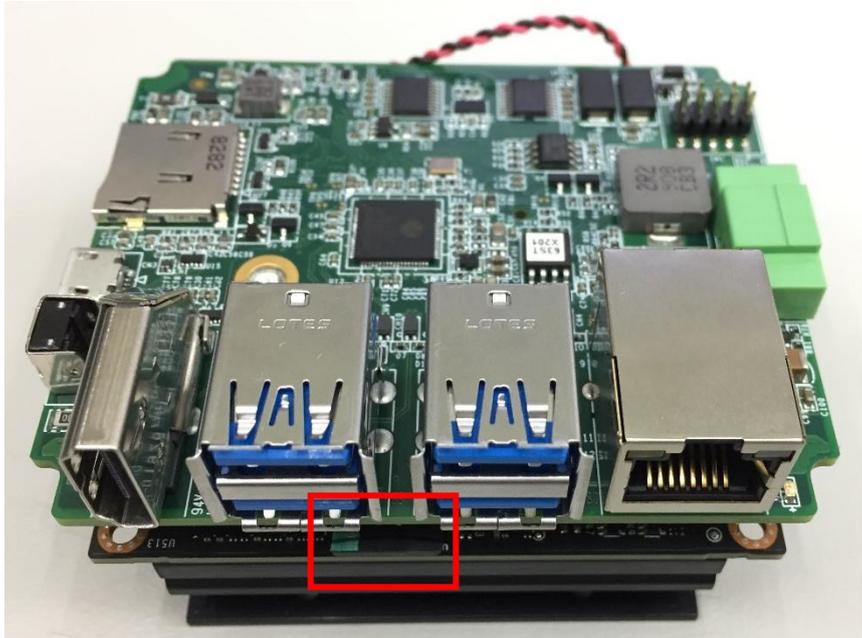
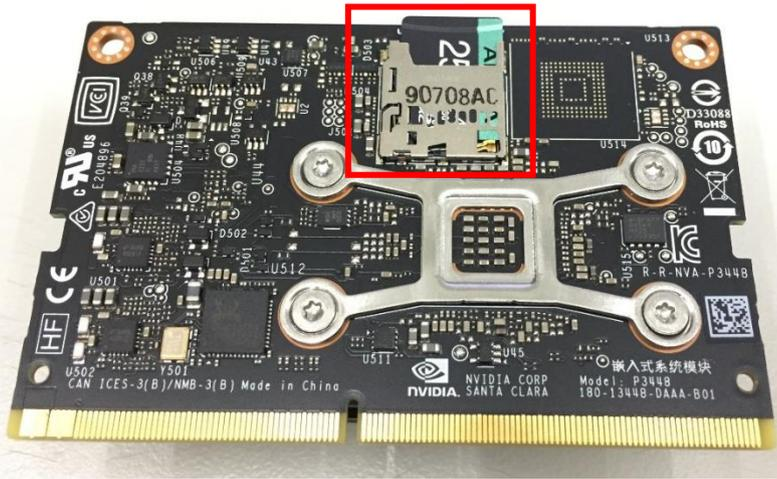

3.3 Flash to System

This section details the steps to flashing the Linux OS to your BOXER-8221AI system.

Note: This section is applicable to the following two installation types:

For Jetson Nano modules with eMMC storage and all versions of NVIDIA JetPack

For Jetson Nano modules with microSD storage and NVIDIA JetPack 4.5 or later

If you are using a Jetson Nano module with microSD storage and wish to install an OS image with a version of JetPack prior to 4.5, see the previous section, Ch 3.2 Flash to microSD Card.

If you have any questions or are unsure which Linux OS image you should download, or need help with installation, please contact AAEON support or ask your AAEON representative for assistance.

3.3.1 Before Installation

Before beginning the process ensure you have the following:

- One host PC with operating system Ubuntu 16.04 or 18.04
- Operating System image downloaded to host computer
- USB Cable with at least one Micro USB connector
- For Jetson Nano modules without eMMC storage, insert a microSD Card with a capacity 16MB or greater.

Make sure the NVIDIA Jetson Nano module is installed onto the BOXER-8221AI carrier board/ system, and the system is turned off and power disconnected.

Download the compressed OS image file. The file name will follow the format of:

ACLinux_4.9_{{OS_IF}}.{{PLF_IF}}.{{PJ_IF}}.{{BN}}.tar.gz

For example:

ACLinux_4.9_{{ACLNX49D}}.{{NV03}}.{{BOXER-8221AI}}.5.tar.gz

Note: Filename may differ from this example.

- I. {{OS_IF}} is OS Information.
- II. {{PLF_IF}} is Platform Information; e.g. **NV03** for Jetson Nano
- III. {{PJ_IF}} is Project Information; e.g. **BOXER-8221AI**
- IV. {{BN}} is Build Number; e.g. 0, 1, 2, etc.

3.3.2 Connecting to PC/ Force Recovery Mode

On Host Computer, open Linux terminal and enter the following command to extract compressed OS image files (*file name may vary*):

```
$ tar -zxvf ACLinux_4.9_ACLNX49D.NV03.BOXER-8221AI.5.tar.gz
```

Next, perform the following steps to force the system to start in USB Recovery Mode:

1. Connect the Micro-USB plug on the USB cable to the Recovery Port on the BOXER-8221AI and the other end to an available USB port on the host PC.
2. Connect the BOXER-8221AI power supply.
3. Press and hold the recovery key button. While holding the recovery key button, power on the system, and continue to hold the recovery key button for two seconds, then release. The BOXER-8221AI should enter recovery mode.

You can use `lsusb` command on host PC to check if the device is in recovery mode:

```
$ lsusb | grep 0955:7f21
```

You should see the following return if device is in recovery mode:

```
0955:7f21 Nvidia Corp
```

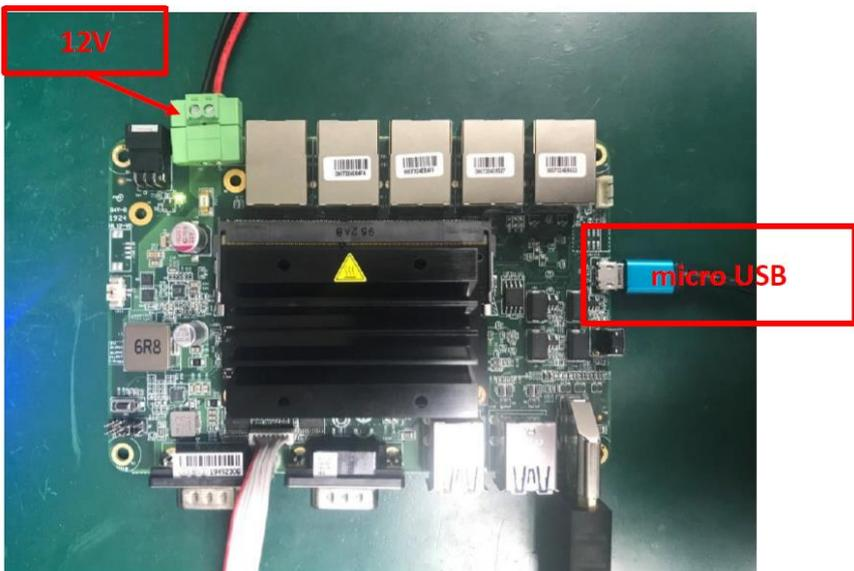

3.3.3 Flash Image to Board

Use the following steps to flash the OS to the BOXER-8221AI.

1. Open terminal on Ubuntu host PC, then access the bootloader folder you extracted in the previous section.
2. Enter the following command in terminal to flash the image:

```
$ sudo ./flashall.sh
```

3. Wait as the image is installed. Once finished you should see the following:

```
1.7289 | Sending bCts
1.7373 | tegrarcn --download bct P3448_A00_4GB_Mlcron_4GB_lpddr4_204Mhz_P987.bct
1.7427 | Applet version 00.01.0000
1.7639 | Sending bct
1.7650 | [.....] 100%
1.9759 |
1.9762 | Sending bootloader and pre-requisite binaries
1.9848 | tegrarcn --download ebt cboot.bin 0 0 --download rp1 tegra210-p3448-0000-p3449-0000-a02.dtb 0
1.9897 | Applet version 00.01.0000
2.0126 | Sending ebt
2.0173 | [.....] 100%
2.1653 | Sending rp1
2.1673 | [.....] 100%
2.2013 |
2.2090 | tegrarcn --boot recovery
2.2162 | Applet version 00.01.0000
2.2465 |
2.2467 | Retrieving storage infomation
2.2526 | tegrarcn --oem platformdetails storage storage_info.bin
2.2626 | Applet is not running on device. Continue with Bootloader
3.3943 |
3.4003 | tegradevflash --oem platformdetails storage storage_info.bin
3.4093 | Cboot version 00.01.0000
3.4151 | Saved platform info in storage_info.bin
3.4237 |
3.4245 | Flashing the device
3.4339 | tegradevflash --pt flash.xml.bin --storageinfo storage_info.bin --create
3.4397 | Cboot version 00.01.0000
3.4453 | Writing partition GPT with gpt.bin
3.4485 | [.....] 100%
3.4582 | Writing partition NVC with nvtboot.bin.encrypt
21.1359 | [.....] 100%
21.1478 | Writing partition PT with flash.xml.bin
31.4071 | [.....] 100%
31.4118 | Writing partition VER with qspi_bootblob_ver.txt
31.6668 | [.....] 100%
31.6807 | Writing partition APP with system.Img
31.9519 | [.....] 100%
1358.2431 | Writing partition TBC with nvtboot_cpu.bin.encrypt
1366.3357 | [.....] 100%
1366.3485 | Writing partition RP1 with tegra210-p3448-0000-p3449-0000-a02.dtb.encrypt
1366.3918 | [.....] 100%
1366.4219 | Writing partition EBT with cboot.bin.encrypt
1366.4759 | [.....] 100%
1366.5147 | Writing partition WBO with warmboot.bin.encrypt
1366.7052 | [.....] 100%
1366.7088 | Writing partition BPF with sc7entry-firmware.bin.encrypt
1366.7488 | [.....] 100%
1366.7587 | Writing partition TOS with tos-mon-only.Img.encrypt
1366.7947 | [.....] 100%
1366.8119 | Writing partition DTB with tegra210-p3448-0000-p3449-0000-a02.dtb.encrypt
1366.8546 | [.....] 100%
1366.8644 | Writing partition LNX with boot.Img.encrypt
1366.9316 | [.....] 100%
1366.9756 | Warning: EKS partition magic header mismatch!
1367.0848 | Writing partition EKS with eks.Img
1367.0892 | [.....] 100%
1367.0927 | Writing partition BMP with bmp.blob
1367.1349 | [.....] 100%
1367.1487 | Writing partition RP4 with rp4.blob
1367.1917 | [.....] 100%
1367.2571 |
1367.2652 | tegradevflash --write BCT P3448_A00_4GB_Mlcron_4GB_lpddr4_204Mhz_P987.bct
1367.2749 | cboot version 00.01.0000
1367.2778 | Writing partition BCT with P3448_A00_4GB_Mlcron_4GB_lpddr4_204Mhz_P987.bct
1367.2857 | [.....] 100%
1373.9389 |
1373.9392 | Flashing completed
```