

BOXER-6843-ADS

Fanless Embedded Controller

User's Manual 1st Ed

Copyright Notice

This document is copyrighted, 2023. All rights are reserved. The original manufacturer reserves the right to make improvements to the products described in this manual at any time without notice.

No part of this manual may be reproduced, copied, translated, or transmitted in any form or by any means without the prior written permission of the original manufacturer. Information provided in this manual is intended to be accurate and reliable. However, the original manufacturer assumes no responsibility for its use, or for any infringements upon the rights of third parties that may result from its use.

The material in this document is for product information only and is subject to change without notice. While reasonable efforts have been made in the preparation of this document to assure its accuracy, AAEON assumes no liabilities resulting from errors or omissions in this document, or from the use of the information contained herein.

AAEON reserves the right to make changes in the product design without notice to its users.

Acknowledgement

All other product name or trademarks are properties of their respective owners.

- Microsoft Windows® is a registered trademark of Microsoft Corp.
- Intel® and Celeron® are registered trademarks of Intel Corporation
- Core™ is a trademark of Intel Corporation
- Linux® is the registered trademark of Linus Torvalds in the U.S. and other countries
- Ubuntu and Canonical are registered trademarks of Canonical Ltd.

All other product names or trademarks are properties of their respective owners. The publisher of this document does not assume nor imply ownership of any trademarked product not listed herein.

Packing List

Before setting up your product, please make sure the following items have been shipped:

| Item | Quantity |
|-----------------------------|----------|
| ● BOXER-6843-ADS | 1 |
| ● Wallmount Kit | 1 |
| ● Screw Pack | 1 |
| ● DC Terminal Block | 1 |
| ● Remote Power On/Off Cable | 1 |
| ● Graphic Cable | 2 |

If any of these items are missing or damaged, please contact your distributor or sales representative immediately.

About this Document

This User's Manual contains all the essential information, such as detailed descriptions and explanations on the product's hardware and software features (if any), its specifications, dimensions, jumper/connector settings/definitions, and driver installation instructions (if any), to facilitate users in setting up their product.

Users may refer to the product page at AAEON.com for the latest version of this document.

Safety Precautions

Please read the following safety instructions carefully. It is advised that you keep this manual for future references

1. All cautions and warnings on the device should be noted.
2. Make sure the power source matches the power rating of the device.
3. Position the power cord so that people cannot step on it. Do not place anything over the power cord.
4. Always completely disconnect the power before working on the system's hardware.
5. No connections should be made when the system is powered as a sudden rush of power may damage sensitive electronic components.
6. If the device is not to be used for a long time, disconnect it from the power supply to avoid damage by transient over-voltage.
7. Always disconnect this device from any power supply before cleaning.
8. While cleaning, use a damp cloth instead of liquid or spray detergents.
9. Make sure the device is installed near a power outlet and is easily accessible.
10. Keep this device away from humidity.
11. Place the device on a solid surface during installation to prevent falls.
12. Do not cover the openings on the device to ensure optimal heat dissipation.
13. Watch out for high temperatures when the system is running.
14. Do not touch the heat sink or heat spreader when the system is running
15. Never pour any liquid into the openings. This could cause fire or electric shock.
16. As most electronic components are sensitive to static electrical charge, be sure to ground yourself to prevent static charge when installing the internal components. Use a grounding wrist strap and contain all electronic components in any static-shielded containers.

17. If any of the following situations arises, please contact our service personnel:
 - i. Damaged power cord or plug
 - ii. Liquid intrusion to the device
 - iii. Exposure to moisture
 - iv. Device is not working as expected or in a manner as described in this manual
 - v. The device is dropped or damaged
 - vi. Any obvious signs of damage displayed on the device
18. Do not leave this device in an uncontrolled environment with temperatures beyond the device's permitted storage temperatures (see chapter 1) to prevent damage.
19. Do NOT disassemble the motherboard so as not to damage the system or void your warranty.
20. If the thermal pad had been damaged, please contact AAEON's salesperson to purchase a new one. Do NOT use those of other brands.
21. The Hex Cylinder Coppers on the front panel are not removable.
22. Repeatedly assemble and disassemble the system may cause damages to the exterior paint and surface and screw holes.
23. Use the right size screwdriver.
24. Use the screwdriver correctly to remove screws from the system.

FCC Statement

Warning!



This device complies with Part 15 FCC Rules. Operation is subject to the following two conditions: (1) this device may not cause harmful interference, and (2) this device must accept any interference received including interference that may cause undesired operation.

Caution:

There is a danger of explosion if the battery is incorrectly replaced. Replace only with the same or equivalent type recommended by the manufacturer. Dispose of used batteries according to the manufacturer's instructions and your local government's recycling or disposal directives.

Attention:

Il y a un risque d'explosion si la batterie est remplacée de façon incorrecte. Ne la remplacer qu'avec le même modèle ou équivalent recommandé par le constructeur. Recycler les batteries usées en accord avec les instructions du fabricant et les directives gouvernementales de recyclage.

产品中有毒有害物质或元素名称及含量

AAEON System

QO4-381 Rev.A0

| 部件名称 | 有毒有害物质或元素 | | | | | |
|-----------------|-----------|-----------|-----------|-----------------|---------------|-----------------|
| | 铅 (Pb) | 汞 (Hg) | 镉 (Cd) | 六价铬 (Cr(VI)) | 多溴联苯 (PBB) | 多溴二苯 醚(PBDE) |
| 印刷电路板 及其电子组件 | × | ○ | ○ | ○ | ○ | ○ |
| 外部信号 连接器及线材 | × | ○ | ○ | ○ | ○ | ○ |
| 外壳 | ○ | ○ | ○ | ○ | ○ | ○ |
| 中央处理器 与内存 | × | ○ | ○ | ○ | ○ | ○ |
| 硬盘 | × | ○ | ○ | ○ | ○ | ○ |
| 液晶模块 | × | × | ○ | ○ | ○ | ○ |
| 光驱 | × | ○ | ○ | ○ | ○ | ○ |
| 触控模块 | × | ○ | ○ | ○ | ○ | ○ |
| 电源 | × | ○ | ○ | ○ | ○ | ○ |
| 电池 | × | ○ | ○ | ○ | ○ | ○ |

本表格依据 SJ/T 11364 的规定编制。

○：表示该有毒有害物质在该部件所有均质材料中的含量均在 GB/T 26572 标准规定的限量要求以下。

×：表示该有害物质的某一均质材料超出了 GB/T 26572 的限量要求，然而该部件

仍符合欧盟指令 2011/65/EU 的规范。

备注：

- 一、此产品所标示之环保使用期限，系指在一般正常使用状况下。
- 二、上述部件物质中央处理器、内存、硬盘、光驱、电源为选购品。
- 三、上述部件物质液晶模块、触控模块仅一体机产品适用。

Hazardous and Toxic Materials List

AAEON System

QO4-381 Rev.A0

| Component Name | Hazardous or Toxic Materials or Elements | | | | | |
|--|--|--------------|--------------|------------------------------|---------------------------------|--|
| | Lead (Pb) | Mercury (Hg) | Cadmium (Cd) | Hexavalent Chromium (Cr(VI)) | Polybrominated biphenyls (PBBS) | Polybrominated diphenyl ethers (PBDES) |
| PCB and Components | X | O | O | O | O | O |
| Wires & Connectors for Ext.Connections | X | O | O | O | O | O |
| Chassis | O | O | O | O | O | O |
| CPU & RAM | X | O | O | O | O | O |
| HDD Drive | X | O | O | O | O | O |
| LCD Module | X | X | O | O | O | O |
| Optical Drive | X | O | O | O | O | O |
| Touch Control Module | X | O | O | O | O | O |
| PSU | X | O | O | O | O | O |
| Battery | X | O | O | O | O | O |

This form is prepared in compliance with the provisions of SJ/T 11364.

O: The level of toxic or hazardous materials present in this component and its parts is below the limit specified by GB/T 26572.

X: The level of toxic of hazardous materials present in the component exceed the limits specified by GB/T 26572, but is still in compliance with EU Directive 2011/65/EU (RoHS 2).

Notes:

1. The Environment Friendly Use Period indicated by labelling on this product is applicable only to use under normal conditions.
2. Individual components including the CPU, RAM/memory, HDD, optical drive, and PSU are optional.
3. LCD Module and Touch Control Module only applies to certain products which feature these components.

Table of Contents

- Chapter 1 - Product Specifications 1
 - 1.1 Specifications..... 2
- Chapter 2 – Hardware Information 5
 - 2.1 Dimensions 6
 - 2.2 Jumpers and Connectors 9
 - 2.3 List of Jumpers 10
 - 2.3.1 Clear CMOS Jumper (JP1) 10
 - 2.3.2 AT/ATX Mode Selection (JP3) 10
 - 2.3.3 PEG Lanes CFG2/PCI Express x16 Lane Selection (JP4) 11
 - 2.3.4 PEG Lanes CFG2 Selection (JP5)..... 11
 - 2.4 List of Connectors 12
 - 2.4.1 PCIe [x4] Slot (CN1) 14
 - 2.4.2 Dual DP Port (CN4) 17
 - 2.4.3 LAN + USB 3.2 x 2 Connector (CN5) 19
 - 2.4.4 LAN + USB 3.2 x 2 Connector (CN6) 21
 - 2.4.5 LAN + USB 3.2 x 2 Connector (CN7) 22
 - 2.4.6 LAN + USB 3.2 x 2 Connector (CN8) 24
 - 2.4.7 M.2 3052 B-Key (CN9) 25
 - 2.4.8 M.2 B-Key Nano SIM Card (CN10) 27
 - 2.4.9 M.2 2230 E-Key (CN11) 28
 - 2.4.10 Remote Button Connector (CN13) 30
 - 2.4.11 SPI Flash Port (CN14)..... 30
 - 2.4.12 eSPI Port (Debug Card Connector) (CN15) 31
 - 2.4.13 SATA Port (CN16/CN17/CN56/CN58) 32
 - 2.4.14 SATA Power (CN18/CN19/CN57/CN59)..... 32
 - 2.4.15 DIO Connector (CN20)..... 33

| | | |
|-----------------------------------|--|-----------|
| 2.4.16 | Dual COM Connector RS-232/422/485 (CN22) | 34 |
| 2.4.17 | USB 2.0 Wafer Box (CN24/CN25/CN26/CN27) | 35 |
| 2.4.18 | Audio Wafer (CN29) | 35 |
| 2.4.19 | DC-In Connector (CN30) | 36 |
| 2.4.20 | M.2 2280 M-Key 1 (CN31) | 36 |
| 2.4.21 | PEG [x16] Slot (CN36) | 38 |
| 2.4.22 | Mini PCIe Socket (CN37) | 41 |
| 2.4.23 | 2X4 PEG Power (CN50/CN51/CN68) | 44 |
| 2.4.24 | COM Port 1 Wafer Box (Optional) (CN52) | 45 |
| 2.4.25 | COM Port 2 Wafer Box (Optional) (CN53) | 46 |
| 2.4.26 | COM Port 3 Wafer Box (Optional) (CN54) | 47 |
| 2.4.27 | COM Port 4 Wafer Box (Optional) (CN55) | 48 |
| 2.4.28 | System Fan Connector (CN60/CN65) | 49 |
| 2.4.29 | COM Port 5 Wafer Box (Optional) (CN61) | 50 |
| 2.4.30 | COM Port 6 Wafer Box (Optional) (CN62) | 51 |
| 2.4.31 | M.2 2280 M-Key 2 (CN63) | 52 |
| 2.4.32 | Dual HDMI (CN64) | 54 |
| 2.4.33 | Mini PCIe Nano SIM Card (CN67) | 56 |
| 2.4.34 | CPU Fan Connector (CN69) | 57 |
| 2.4.35 | Battery Connector (BAT1) | 57 |
| 2.5 | CPU Installation | 58 |
| 2.6 | SATA Installation | 59 |
| 2.7 | Expansion Module and Mini Card Location | 60 |
| 2.8 | RAM Module Installation | 61 |
| Chapter 3 - AMI BIOS Setup | | 64 |
| 3.1 | System Test and Initialization | 65 |
| 3.2 | AMI BIOS Setup | 66 |
| 3.3 | Setup Submenu: Main | 67 |

| | | |
|---------|---|-----|
| 3.4 | Setup Submenu: Advanced | 68 |
| 3.4.1 | CPU Configuration | 69 |
| 3.4.2 | Memory Configuration..... | 70 |
| 3.4.3 | PCH-FW Configuration..... | 71 |
| 3.4.3.1 | Firmware Update Configuration..... | 72 |
| 3.4.4 | Hardware Monitor | 73 |
| 3.4.4.1 | Smart Fan Mode Configuration | 74 |
| 3.4.5 | Power Management..... | 78 |
| 3.4.6 | AAEON BIOS Robot..... | 79 |
| 3.4.6.1 | Device Detecting Configuration | 81 |
| 3.5 | Setup Submenu: System I/O..... | 87 |
| 3.5.1 | PCI Express Configuration..... | 88 |
| 3.5.2 | Storage Configuration | 90 |
| 3.5.2.1 | NVMe Configuration | 92 |
| 3.5.3 | HD Audio Configuration | 93 |
| 3.5.4 | Digital IO Port Configuration | 94 |
| 3.5.5 | Legacy Logical Devices Configuration | 96 |
| 3.5.5.1 | Serial Port 1..... | 97 |
| 3.5.5.2 | Serial Port 2 | 98 |
| 3.5.5.3 | Serial Port 3 | 99 |
| 3.5.5.4 | Serial Port 4..... | 100 |
| 3.5.5.5 | Serial Port 5 | 101 |
| 3.5.5.6 | Serial Port 6 | 102 |
| 3.5.6 | Serial Port Console Redirection..... | 103 |
| 3.5.6.1 | Console Redirection Settings (COM0) | 104 |
| 3.5.6.2 | Console Redirection Settings (Out-of-Band Mgmt) | 107 |
| 3.6 | Setup Submenu: Security | 109 |
| 3.6.1 | Trusted Computing..... | 110 |

| | | |
|---|--|------------|
| 3.6.2 | Secure Boot..... | 112 |
| 3.6.2.1 | Key Management..... | 113 |
| 3.7 | Setup Submenu: Boot..... | 115 |
| 3.7.1 | UEFI Hard Disk Drive BBS Priorities..... | 116 |
| 3.8 | Setup Submenu: Save & Exit | 117 |
| 3.9 | Setup Submenu: MEBx..... | 118 |
| Chapter 4 – Drivers Installation | | 119 |
| 4.1 | Drivers Download and Installation..... | 120 |
| Appendix A - I/O Information..... | | 122 |
| A.1 | I/O Address Map..... | 123 |
| A.2 | IRQ Mapping Chart | 124 |
| A.3 | Memory Address Map..... | 134 |
| A.4 | Large Memory Address Map..... | 135 |

Chapter 1

Product Specifications

1.1 Specifications

System

| | |
|--------------------------|---|
| CPU | 12 th /13 th Generation Intel® Core™/Celeron® Processor G Series, LGA-1700 Socket Type, TDP Max. 65W (LGA 6+0, LGA 8+8) 13th Generation Intel® Core™ Processors: Intel® Core™ i9-13900TE/i9-13900E Intel® Core™ i7-13700E Intel® Core™ i5-13500E Intel® Core™ i3-13100TE 12th Generation Intel® Core™/Celeron® Processor G Series Processors: Intel® Core™ i9-12900TE/i9-12900E Intel® Core™ i7-12700TE/i7-12700E Intel® Core™ i5-12500TE/i5-12500E Intel® Core™ i3-12100TE/i3-12100E Intel® Celeron® Processor G6900TE/G6900E |
| Chipset | Intel® Q670E |
| System Memory | DDR5 4800MHz U-DIMM x 4, up to 128GB |
| Display Interface | HDMI (Type-A) x 2 Display Port x 2 |
| Storage Device | 2.5" SATA Drive Bay x 2 (external, swappable) M.2 2280 M-Key x 2 (PCIe Gen 4 [x4]) 3.5" SATA Drive Bay (internal, non-swappable, optional) |
| Ethernet | 2.5GbE x 3 (Intel® I226-IT) GbE x 1 with LED Indicator (Intel® I219-LM) |

System

| | |
|-------------------|---|
| I/O | <p>HDMI x 2, Display Port x 2</p> <p>RJ-45 x 4</p> <p>USB 3.2 Gen 2 (Type-A) x 8</p> <p>DB-9 Male x 6 for RS-232/422/485 (Autoflow, Programmable)</p> <p>DB-15 Male x 1 for 8-bit DIO</p> <p>Audio (Mic-in/Line-out)</p> <p>DC 19V ~ 36V 3-pin Terminal Block Connector</p> <p>Power Button with LED x 1</p> <p>Remote Power On/Off x 1</p> <p>Reset Button x 1</p> |
| Expansion | <p>M.2 2230 E-Key x 1</p> <p>M.2 3052 B-Key x 1 w/SIM</p> <p>M.2 2280 M-Key/B+M-Key x 2</p> <p>Full-Size Mini Card x 1 (PCIe + USB)</p> |
| Indicator | — |
| OS Support | <p>Windows® 10 IoT Enterprise LTSC 2021</p> <p>Windows® 11 Pro</p> <p>Linux Ubuntu 22.04</p> |

Power Supply

| | |
|--------------------------|-----------------------------------|
| Power Requirement | DC 19V ~ 36V 3-pin Terminal Block |
|--------------------------|-----------------------------------|

Mechanical

| | |
|-------------------------------|---|
| Mounting | Wallmount |
| Dimensions (W x H x D) | 7.35" x 8.92" x 14.76" (186.8mm x 226.5mm x 375mm) without brackets 7.35" x 9.19" x 16.50" (186.8mm x 233.5mm x 419mm) with brackets |
| Gross Weight | TBD |
| Net Weight | TBD |

Environmental

| | |
|------------------------------|--|
| Operating Temperature | -4°F ~ 113°F (-20°C ~ 45°C) with 0.5 m/s airflow – (w/ SSD) |
| Storage Temperature | -40°F ~ 176°F (-40°C ~ 80°C) |
| Storage Humidity | 5 ~ 95% @ 40°C, non-condensing |
| Anti-Vibration | Random, 1 Grms, 5~500Hz (w/ SSD) |
| Anti-Shock | With SSD: 25 G, IEC 60068-2-27, half sine, 11 ms duration |
| Certification | CE/FCC Class A |

Chapter 2

Hardware Information

2.1 Dimensions

System Dimensions

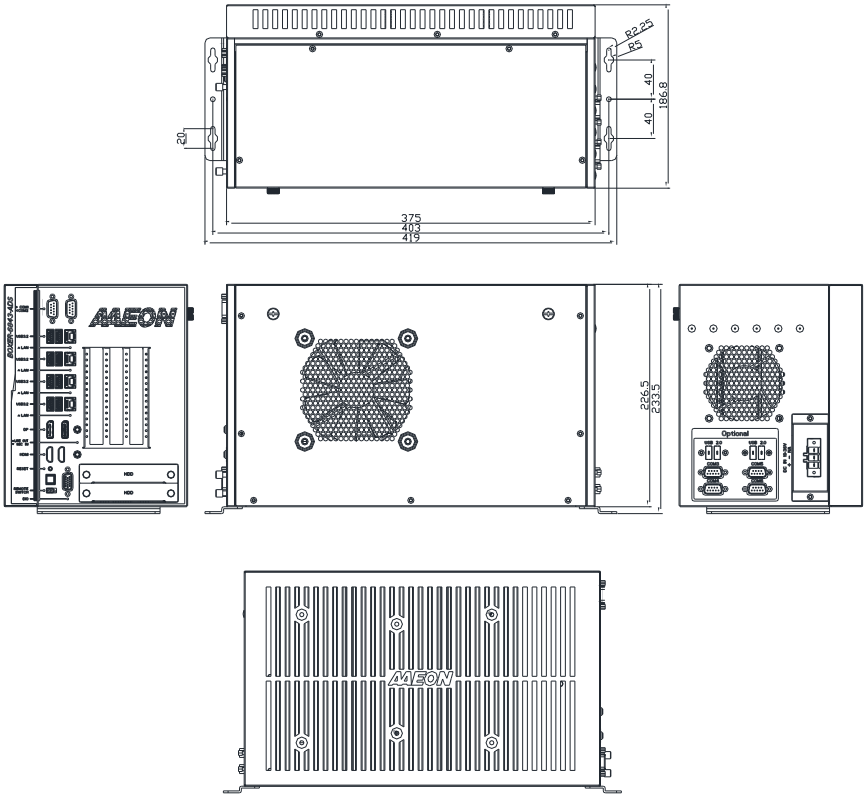

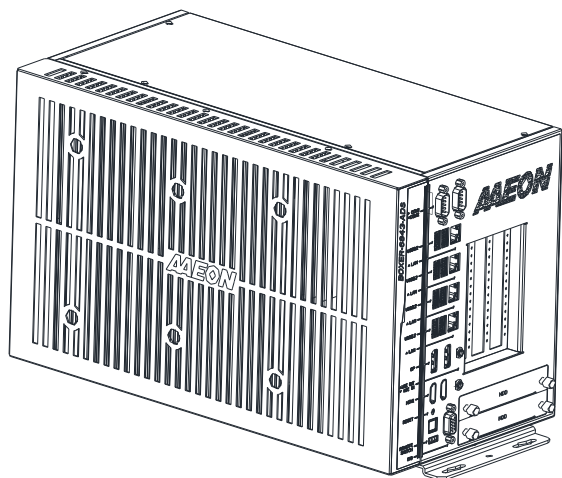

SCALE 1:2

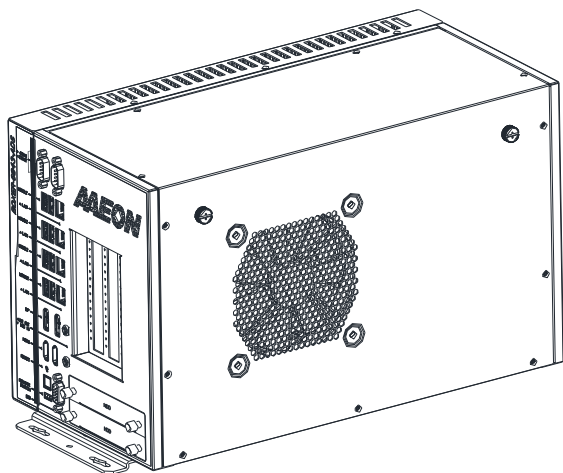

SCALE 1:2

Main Board Dimensions

Unit:mm

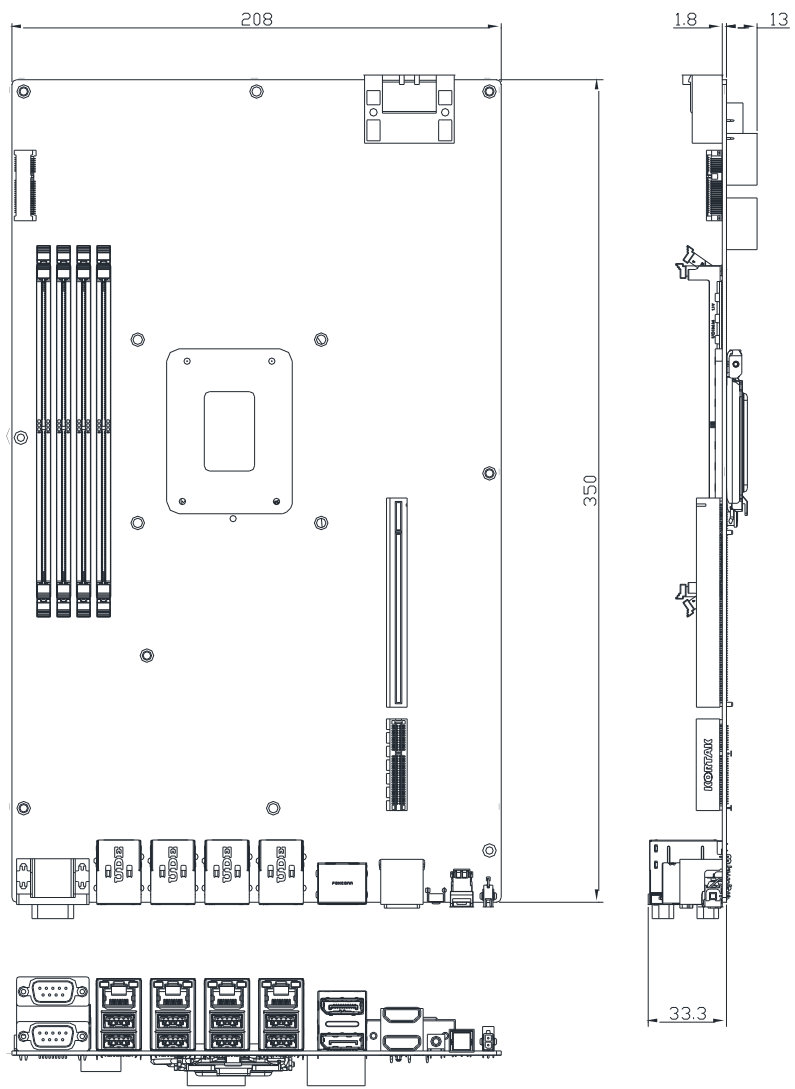

2.2 Jumpers and Connectors

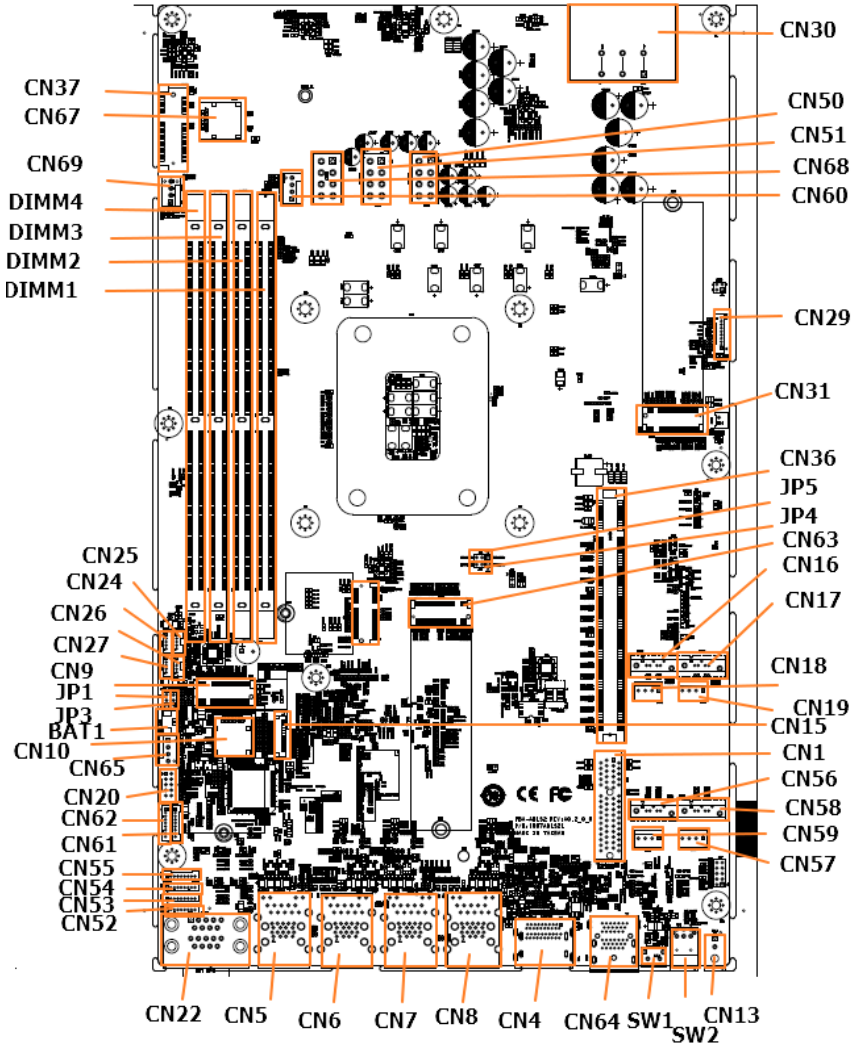

2.3 List of Jumpers

Please refer to the table below for all of the system's jumpers that you can configure for your application.

| Label | Function |
|-------|--|
| JP1 | Clear CMOS Jumper |
| JP3 | AT/ATX Mode Selection |
| JP4 | PEG Lanes CFG2 Selection PCI Express x16 Lane Selection |
| JP5 | PEG Lanes CFG2 Selection |

2.3.1 Clear CMOS Jumper (JP1)

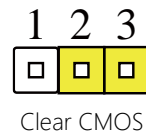
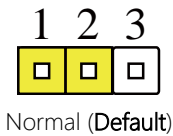

2.3.2 AT/ATX Mode Selection (JP3)

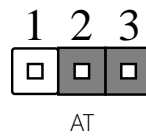
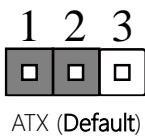

Note: AT Mode JP3(2-3): ATX power button JP3 (1-2) to power on the system.

2.3.3 PEG Lanes CFG2/PCI Express x16 Lane Selection (JP4)

0 = Lane reverse

1 = Lane normal

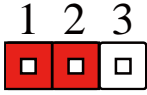

Lane normal

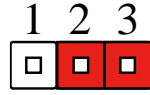

Lane reverse (default)

2.3.4 PEG Lanes CFG2 Selection (JP5)

CFG [6:5]: PCI Express Bifurcation

10 = 2 x8 PCI Express

11 = 1 x16 PCI Express

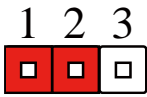

x16

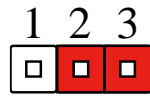

x8

2.4 List of Connectors

Please refer to the table below for all of the system's connectors that you can configure for your application

| Label | Function |
|-------|-----------------------------|
| CN1 | PCIe [x4] Slot |
| CN4 | Dual DP Port |
| CN5 | LAN + USB 3.2 x 2 Connector |
| CN6 | LAN + USB 3.2 x 2 Connector |
| CN7 | LAN + USB 3.2 x 2 Connector |
| CN8 | LAN + USB 3.2 x 2 Connector |
| CN9 | M.2 3052 B-Key |
| CN10 | M.2 B-Key Nano SIM Card |
| CN11 | M.2 2230 E-Key |
| CN13 | Remote Button |
| CN14 | SPI Flash Port |
| CN15 | ESPI Port |
| CN16 | SATA 2 |
| CN17 | SATA 1 |
| CN18 | SATA Power |
| CN19 | SATA Power |
| CN20 | DIO Connector |
| CN22 | Dual COM Connector |
| CN24 | USB 2.0 Header |
| CN25 | USB 2.0 Header |
| CN26 | USB 2.0 Header |
| CN27 | USB 2.0 Header |
| CN29 | Audio Wafer |
| CN30 | DC-In Connector |

| Label | Function |
|-------|-------------------------|
| CN31 | M.2 2280 M-Key 1 |
| CN36 | PEG [x16] Slot |
| CN37 | Mini PCIe Socket |
| CN50 | 2X4 PEG Power |
| CN51 | 2X4 PEG Power |
| CN52 | COM Port 1 Wafer Box |
| CN53 | COM Port 2 Wafer Box |
| CN54 | COM Port 3 Wafer Box |
| CN55 | COM Port 4 Wafer Box |
| CN56 | SATA 4 |
| CN57 | SATA Power |
| CN58 | SATA 3 |
| CN59 | SATA Power |
| CN60 | SYS Fan 1 |
| CN61 | COM Port 5 Wafer Box |
| CN62 | COM Port 6 Wafer Box |
| CN63 | M.2 2280 M-Key 2 |
| CN64 | Dual HDMI |
| CN65 | System Fan 2 |
| CN67 | Mini PCIe Nano SIM Card |
| CN68 | 2X4 PEG Power |
| CN69 | CPU Fan |
| BAT1 | Battery Connector |

2.4.1 PCIe [x4] Slot (CN1)

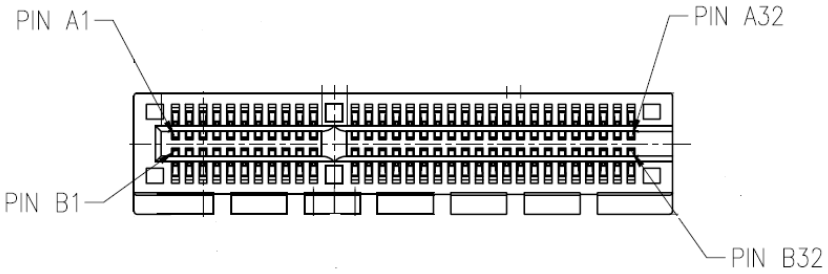

| Pin | Pin Name | Signal Type | Signal Level |
|-----|------------------|-------------|--------------|
| A1 | PRSNT1# | I/O | |
| A2 | +12V | PWR | +12V |
| A3 | +12V | PWR | +12V |
| A4 | GND | GND | |
| A5 | PCIE_TXN5 | DIFF | |
| A6 | PCIE_TXP5 | DIFF | |
| A7 | PCIE_RXN5 | DIFF | |
| A8 | PCIE_RXP5 | DIFF | |
| A9 | +3.3V | PWR | +3.3V |
| A10 | +3.3V | PWR | +3.3V |
| A11 | PERST# | I/O | |
| A12 | GND | GND | |
| A13 | PCIE_x4SLOT_CLK | DIFF | |
| A14 | PCIE_x4SLOT_CLK# | DIFF | |
| A15 | GND | GND | |
| A16 | PCIE_RXP24 | DIFF | |
| A17 | PCIE_RXN24 | DIFF | |
| A18 | GND | GND | |
| A19 | NC | | |
| A20 | GND | GND | |
| A21 | PCIE_RXP23 | DIFF | |

| Pin | Pin Name | Signal Type | Signal Level |
|-----|------------|-------------|--------------|
| A22 | PCIE_RXN23 | DIFF | |
| A23 | GND | GND | |
| A24 | GND | GND | |
| A25 | PCIE_RXP22 | DIFF | |
| A26 | PCIE_RXN22 | DIFF | |
| A27 | GND | GND | |
| A28 | GND | GND | |
| A29 | PCIE_RXP21 | DIFF | |
| A30 | PCIE_RXN21 | DIFF | |
| A31 | GND | GND | |
| A32 | NC | | |
| B1 | +12V | PWR | +12V |
| B2 | +12V | PWR | +12V |
| B3 | +12V | PWR | +12V |
| B4 | GND | GND | |
| B5 | SMB_CLK | I/O | |
| B6 | SMB_CLK | I/O | |
| B7 | GND | GND | |
| B8 | +V3.3S | PWR | +3.3V |
| B9 | NC | | |
| B10 | 3.3Vaux | PWR | +3.3V |
| B11 | WAKE# | I/O | |
| B12 | NC | | |
| B13 | GND | GND | |
| B14 | PCIE_TXP24 | DIFF | |
| B15 | PCIE_TXN24 | DIFF | |
| B16 | GND | GND | |
| B17 | PRSNT | I/O | |
| B18 | GND | GND | |

| Pin | Pin Name | Signal Type | Signal Level |
|-----|------------|-------------|--------------|
| B19 | PCIE_TXP23 | DIFF | |
| B20 | PCIE_TXN23 | DIFF | |
| B21 | GND | GND | |
| B22 | GND | GND | |
| B23 | PCIE_TXP22 | DIFF | |
| B24 | PCIE_TXN22 | DIFF | |
| B25 | GND | GND | |
| B26 | GND | GND | |
| B27 | PCIE_TXP21 | DIFF | |
| B28 | PCIE_TXN21 | DIFF | |
| B29 | GND | GND | |
| B30 | NC | | |
| B31 | PRSNT | I/O | |
| B32 | GND | GND | |

2.4.2 Dual DP Port (CN4)

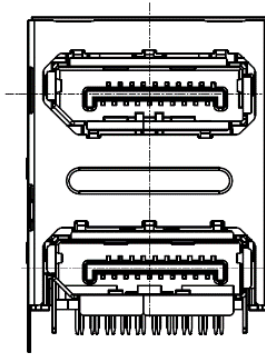

| Pin | Pin Name | Signal Type | Signal Level |
|-----|--------------|-------------|--------------|
| P1 | DP1_DATA0 _P | DIFF | |
| P2 | GND | GND | |
| P3 | DP1_DATA0 _N | DIFF | |
| P4 | DP1_DATA1 _P | DIFF | |
| P5 | GND | GND | |
| P6 | DP1_DATA1 _N | DIFF | |
| P7 | DP1_DATA2 _P | DIFF | |
| P8 | GND | GND | |
| P9 | DP1_DATA1 _N | DIFF | |
| P10 | DP1_DATA3 _P | DIFF | |
| P11 | GND | GND | |
| P12 | DP1_DATA3 _N | DIFF | |
| P13 | CONFIG1 | | |
| P14 | CONFIG2 | | |
| P15 | DP1_AUX _P | DIFF | |
| P16 | GND | GND | |
| P17 | DP1_AUX _N | DIFF | |
| P18 | DP1_HPD | | |
| P19 | RETURN | | |

| Pin | Pin Name | Signal Type | Signal Level |
|-----|-------------|-------------|--------------|
| P20 | DP1_PWR | PWR | +3.3V |
| P21 | DP2_DATA0_P | DIFF | |
| P22 | GND | GND | |
| P23 | DP2_DATA0_N | DIFF | |
| P24 | DP2_DATA1_P | DIFF | |
| P25 | GND | GND | |
| P26 | DP2_DATA1_N | DIFF | |
| P27 | DP2_DATA2_P | DIFF | |
| P28 | GND | GND | |
| P29 | DP2_DATA1_N | DIFF | |
| P30 | DP2_DATA3_P | DIFF | |
| P31 | GND | GND | |
| P32 | DP2_DATA3_N | DIFF | |
| P33 | CONFIG1 | | |
| P34 | CONFIG2 | | |
| P35 | DP2_AUX_P | DIFF | |
| P36 | GND | GND | |
| P37 | DP2_AUX_N | DIFF | |
| P38 | DP2_HPD | | |
| P39 | RETURN | | |
| P40 | DP2_PWR | PWR | +3.3V |

2.4.3 LAN + USB 3.2 x 2 Connector (CN5)

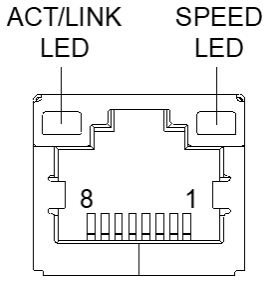

| Pin | Pin Name | Signal Type | Signal Level |
|-----|----------|-------------|--------------|
| 1 | MDI0+ | DIFF | |
| 2 | MDI0- | DIFF | |
| 3 | MDI1+ | DIFF | |
| 4 | MDI1- | DIFF | |
| 5 | MDI2+ | DIFF | |
| 6 | MDI2- | DIFF | |
| 7 | MDI3+ | DIFF | |
| 8 | MDI3- | DIFF | |

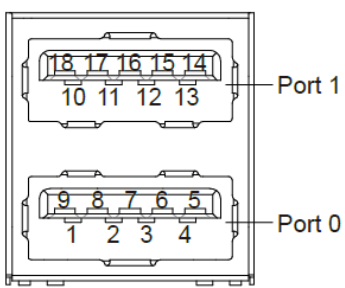

| Pin | Pin Name | Signal Type | Signal Level |
|-----|----------|-------------|--------------|
| 1 | +5VSB | PWR | +5V |
| 2 | USB1_D- | DIFF | |
| 3 | USB1_D+ | DIFF | |
| 4 | GND | GND | |

| Pin | Pin Name | Signal Type | Signal Level |
|-----|------------|-------------|--------------|
| 5 | USB1_SSRX- | DIFF | |
| 6 | USB1_SSRX+ | DIFF | |
| 7 | GND | GND | |
| 8 | USB1_SSTX- | DIFF | |
| 9 | USB1_SSTX+ | DIFF | |
| 10 | +5VSB | PWR | +5V |
| 11 | USB2_D- | DIFF | |
| 12 | USB2_D+ | DIFF | |
| 13 | GND | GND | |
| 14 | USB2_SSRX- | DIFF | |
| 15 | USB2_SSRX+ | DIFF | |
| 16 | GND | GND | |
| 17 | USB2_SSTX- | DIFF | |
| 18 | USB2_SSTX+ | DIFF | |

2.4.4 LAN + USB 3.2 x 2 Connector (CN6)

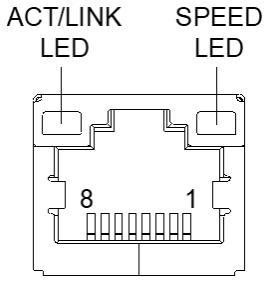

| Pin | Pin Name | Signal Type | Signal Level |
|-----|----------|-------------|--------------|
| 1 | MDI0+ | DIFF | |
| 2 | MDI0- | DIFF | |
| 3 | MDI1+ | DIFF | |
| 4 | MDI1- | DIFF | |
| 5 | MDI2+ | DIFF | |
| 6 | MDI2- | DIFF | |
| 7 | MDI3+ | DIFF | |
| 8 | MDI3- | DIFF | |

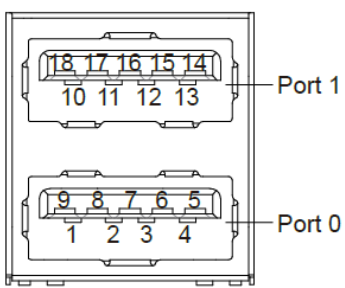

| Pin | Pin Name | Signal Type | Signal Level |
|-----|------------|-------------|--------------|
| 1 | +5VSB | PWR | +5V |
| 2 | USB3_D- | DIFF | |
| 3 | USB3_D+ | DIFF | |
| 4 | GND | GND | |
| 5 | USB3_SSRX- | DIFF | |

| Pin | Pin Name | Signal Type | Signal Level |
|-----|------------|-------------|--------------|
| 6 | USB3_SSRX+ | DIFF | |
| 7 | GND | GND | |
| 8 | USB3_SSTX- | DIFF | |
| 9 | USB3_SSTX+ | DIFF | |
| 10 | +5VSB | PWR | +5V |
| 11 | USB4_D- | DIFF | |
| 12 | USB4_D+ | DIFF | |
| 13 | GND | GND | |
| 14 | USB4_SSRX- | DIFF | |
| 15 | USB4_SSRX+ | DIFF | |
| 16 | GND | GND | |
| 17 | USB4_SSTX- | DIFF | |
| 18 | USB4_SSTX+ | DIFF | |

2.4.5 LAN + USB 3.2 x 2 Connector (CN7)

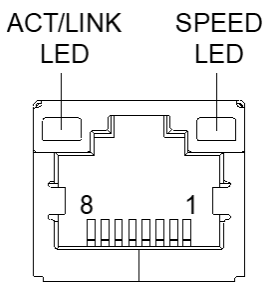

| Pin | Pin Name | Signal Type | Signal Level |
|-----|----------|-------------|--------------|
| 1 | MDI0+ | DIFF | |
| 2 | MDI0- | DIFF | |
| 3 | MDI1+ | DIFF | |
| 4 | MDI1- | DIFF | |
| 5 | MDI2+ | DIFF | |
| 6 | MDI2- | DIFF | |

| Pin | Pin Name | Signal Type | Signal Level |
|-----|----------|-------------|--------------|
| 7 | MDI3+ | DIFF | |
| 8 | MDI3- | DIFF | |

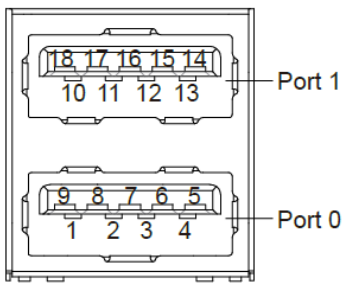

| Pin | Pin Name | Signal Type | Signal Level |
|-----|------------|-------------|--------------|
| 1 | +5VSB | PWR | +5V |
| 2 | USB3_D- | DIFF | |
| 3 | USB3_D+ | DIFF | |
| 4 | GND | GND | |
| 5 | USB3_SSRX- | DIFF | |
| 6 | USB3_SSRX+ | DIFF | |
| 7 | GND | GND | |
| 8 | USB3_SSTX- | DIFF | |
| 9 | USB3_SSTX+ | DIFF | |
| 10 | +5VSB | PWR | +5V |
| 11 | USB4_D- | DIFF | |
| 12 | USB4_D+ | DIFF | |
| 13 | GND | GND | |
| 14 | USB4_SSRX- | DIFF | |
| 15 | USB4_SSRX+ | DIFF | |
| 16 | GND | GND | |
| 17 | USB4_SSTX- | DIFF | |
| 18 | USB4_SSTX+ | DIFF | |

2.4.6 LAN + USB 3.2 x 2 Connector (CN8)

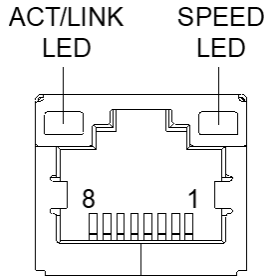

| Pin | Pin Name | Signal Type | Signal Level |
|-----|----------|-------------|--------------|
| 1 | MDI0+ | DIFF | |
| 2 | MDI0- | DIFF | |
| 3 | MDI1+ | DIFF | |
| 4 | MDI1- | DIFF | |
| 5 | MDI2+ | DIFF | |
| 6 | MDI2- | DIFF | |
| 7 | MDI3+ | DIFF | |
| 8 | MDI3- | DIFF | |

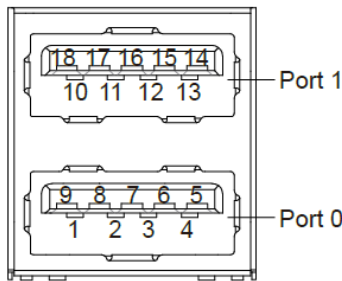

| Pin | Pin Name | Signal Type | Signal Level |
|-----|------------|-------------|--------------|
| 1 | +5VSB | PWR | +5V |
| 2 | USB3_D- | DIFF | |
| 3 | USB3_D+ | DIFF | |
| 4 | GND | GND | |
| 5 | USB3_SSRX- | DIFF | |

| Pin | Pin Name | Signal Type | Signal Level |
|-----|------------|-------------|--------------|
| 6 | USB3_SSRX+ | DIFF | |
| 7 | GND | GND | |
| 8 | USB3_SSTX- | DIFF | |
| 9 | USB3_SSTX+ | DIFF | |
| 10 | +5VSB | PWR | +5V |
| 11 | USB4_D- | DIFF | |
| 12 | USB4_D+ | DIFF | |
| 13 | GND | GND | |
| 14 | USB4_SSRX- | DIFF | |
| 15 | USB4_SSRX+ | DIFF | |
| 16 | GND | GND | |
| 17 | USB4_SSTX- | DIFF | |
| 18 | USB4_SSTX+ | DIFF | |

2.4.7 M.2 3052 B-Key (CN9)

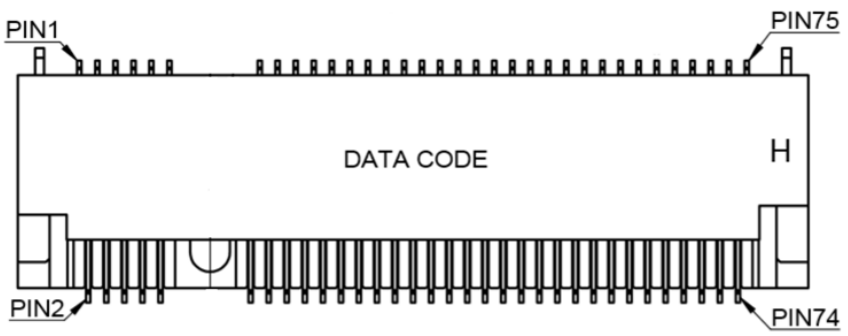

| Pin | Pin Name | Signal Type | Pin | Pin Name | Signal Type | Signal Level |
|-----|-----------|-------------|-----|----------------|-------------|--------------|
| 1 | NC | | 2 | +3.3V | PWR | +3.3V |
| 3 | GND | GND | 4 | +3.3V | PWR | +3.3V |
| 5 | GND | GND | 6 | CARD_PWR_OFF_N | OUT | +3.3V |
| 7 | USB_2.0_P | DIFF | 8 | W_DISABLE | IN | +3.3V |

| Pin | Pin Name | Signal Type | Pin | Pin Name | Signal Type | Signal Level |
|-----|---------------|-------------|-----|----------|-------------|--------------|
| 9 | USB_2.0_N | DIFF | 10 | NC | | |
| 11 | GND | GND | 12 | | | |
| | | | | | | |
| | | | | | | |
| | | | 20 | NC | | |
| 21 | NC | | 22 | NC | | |
| 23 | NC | | 24 | NC | | |
| 25 | NC | | 26 | NC | | |
| 27 | GND | GND | 28 | NC | | |
| 29 | USB3_RXN | DIFF | 30 | UIM_RST | | |
| 31 | USB3_RXP | DIFF | 32 | UIM_CLK | | |
| 33 | GND | GND | 34 | UIM_DATA | | |
| 35 | USB3_TXN | DIFF | 36 | UIM_PWR | | |
| 37 | USB3_TXP | DIFF | 38 | NC | | |
| 39 | GND | GND | 40 | NC | | |
| 41 | PCIE_RXN | DIFF | 42 | NC | | |
| 43 | PCIE_RXP | DIFF | 44 | NC | | |
| 45 | GND | GND | 46 | NC | | |
| 47 | PCIE_TXN | DIFF | 48 | NC | | |
| 49 | PCIE_TXP | DIFF | 50 | RESET# | IN | +3.3V |
| 51 | GND | PWR | 52 | CLKREQ# | OUT | +3.3V |
| 53 | PCIE_M.2_CLK# | DIFF | 54 | WAKE# | OUT | +3.3V |
| 55 | PCIE_M.2_CLK | DIFF | 56 | NC | | |
| 57 | GND | GND | 58 | NC | | |
| 59 | NC | | 60 | NC | | |
| 61 | NC | | 62 | NC | | |
| 63 | NC | | 64 | NC | | |

| Pin | Pin Name | Signal Type | Pin | Pin Name | Signal Type | Signal Level |
|-----|----------|-------------|-----|----------|-------------|--------------|
| 65 | NC | | 66 | NC | | |
| 67 | RESET# | | 68 | SUSCLK | | |
| 69 | NC | | 70 | +3.3V | PWR | +3.3V |
| 71 | GND | GND | 72 | +3.3V | PWR | +3.3V |
| 73 | GND | GND | 74 | +3.3V | PWR | +3.3V |
| 75 | GND | GND | | | | |

2.4.8 M.2 B-Key Nano SIM Card (CN10)

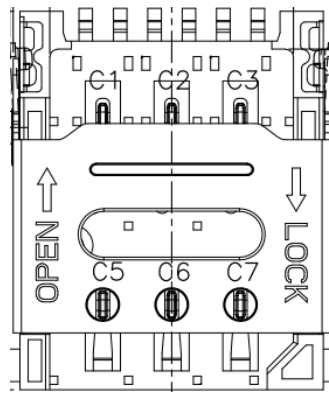

| Pin | Pin Name | Signal Type | Signal Level |
|-----|----------|-------------|--------------|
| C1 | UIM_PWR | PWR | |
| C2 | UIM_RST | IN | |
| C3 | UIM_CLK | IN | |
| C5 | GND | GND | |
| C6 | UIM_VPP | PWR | |
| C7 | UIM_DATA | I/O | |

2.4.9 M.2 2230 E-Key (CN11)

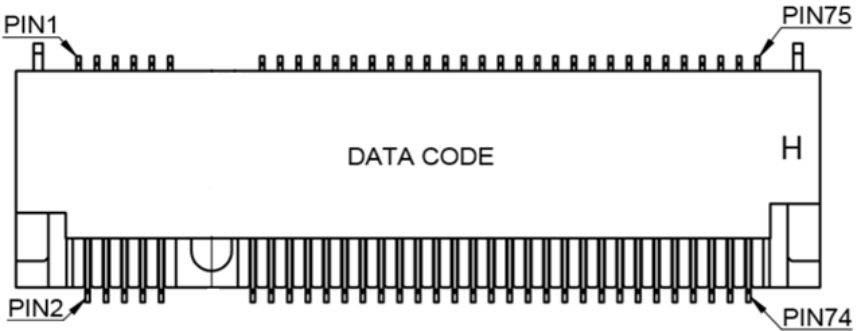

| Pin | Pin Name | Signal Type | Pin | Pin Name | Signal Type | Signal Level |
|-----|----------|-------------|-----|----------|-------------|--------------|
| 1 | GND | | 2 | +3.3V | PWR | +3.3V |
| 3 | USB+ | DIFF | 4 | +3.3V | PWR | +3.3V |
| 5 | USB- | DIFF | 6 | NC | | |
| 7 | GND | | 8 | NC | | |
| 9 | NC | | 10 | NC | | |
| 11 | NC | | 12 | NC | | |
| 13 | NC | | 14 | NC | | |
| 15 | NC | | 16 | NC | | |
| 17 | NC | | 18 | GND | | |
| 19 | NC | | 20 | NC | | |
| 21 | NC | | 22 | NC | | |
| 23 | NC | | | | | |
| | | | | | | |
| | | | | | | |
| | | | | | | |
| | | | 32 | NC | | |
| 33 | GND | GND | 34 | NC | | |
| 35 | PCIE_TXP | DIFF | 36 | NC | | |
| 37 | PCIE_TXN | DIFF | 38 | NC | | |

| Pin | Pin Name | Signal Type | Pin | Pin Name | Signal Type | Signal Level |
|-----|----------------------|-------------|-----|----------|-------------|--------------|
| 39 | GND | GND | 40 | NC | | |
| 41 | PCIE_RXP | DIFF | 42 | NC | | |
| 43 | PCIE_RXN | DIFF | 44 | NC | | |
| 45 | GND | GND | 46 | NC | | |
| 47 | PCIE_M.2_CLK | DIFF | 48 | NC | | |
| 49 | PCIE_M.2_CLK# | DIFF | 50 | SUSCLK | | |
| 51 | GND | | 52 | RESET# | | |
| 53 | PCIE_M2E_CLKR EQ# | | 54 | BT_EN | | |
| 55 | WAKE# | | 56 | WIFI_EN | | |
| 57 | NC | | 58 | SMB_DATA | | |
| 59 | NC | | 60 | SMB_CLK | | |
| 61 | NC | | 62 | NC | | |
| 63 | GND | | 64 | NC | | |
| 65 | NC | | 66 | NC | | |
| 67 | NC | | 68 | NC | | |
| 69 | GND | | 70 | NC | | |
| 71 | NC | | 72 | +3.3V | PWR | +3.3V |
| 73 | NC | | 74 | +3.3V | PWR | +3.3V |
| 75 | GND | GND | | | | |

2.4.10 Remote Button Connector (CN13)

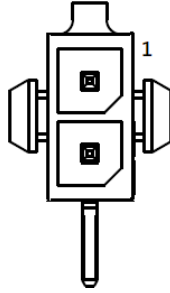

| Pin | Pin Name | Signal Type | Signal Level |
|-----|------------|-------------|--------------|
| 1 | PWR_BUTTON | IN | |
| 2 | GND | GND | |

2.4.11 SPI Flash Port (CN14)

| Pin | Pin Name | Signal Type | Signal Level |
|-----|-----------|-------------|--------------|
| 1 | +3.3M_SPI | PWR | |
| 2 | GND | GND | |
| 3 | SPI_CS | IN | |
| 4 | SPI_CLK | | +3.3V |
| 5 | SPI_MISO | OUT | |
| 6 | SPI_MOSI | IN | |
| 7 | NC | | |
| 8 | NC | | |

2.4.12 eSPI Port (Debug Card Connector) (CN15)

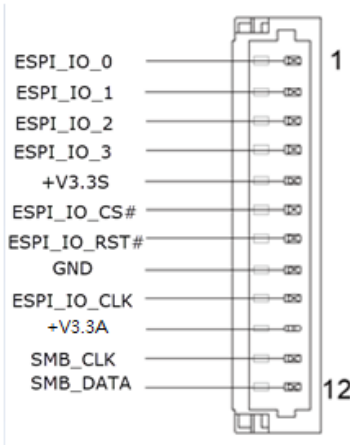

| Pin | Pin Name | Signal Type | Signal Level |
|-----|--------------|-------------|--------------|
| 1 | ESPI_IO_0 | I/O | +1.8V |
| 2 | ESPI_IO_1 | I/O | +1.8V |
| 3 | ESPI_IO_2 | I/O | +1.8V |
| 4 | ESPI_IO_3 | I/O | +1.8V |
| 5 | +3.3V | PWR | +3.3V |
| 6 | ESPI_IO_CS# | IN | |
| 7 | ESPI_IO_RST# | IN | |
| 8 | GND | GND | |
| 9 | EPSI_IO_LCLK | IN | |
| 10 | +3.3V | PWR | +3.3V |
| 11 | SMDAT | I/O | |
| 12 | SMCLK | IN | |

2.4.13 SATA Port (CN16/CN17/CN56/CN58)

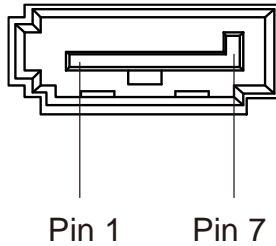

| Pin | Pin Name | Signal Type | Signal Level |
|-----|----------|-------------|--------------|
| 1 | GND | GND | |
| 2 | SATA_TX+ | SATA_TX+ | |
| 3 | SATA_TX- | SATA_TX- | |
| 4 | GND | GND | |
| 5 | SATA_RX- | SATA_RX- | |
| 6 | SATA_RX+ | SATA_RX+ | |
| 7 | GND | GND | |

2.4.14 SATA Power (CN18/CN19/CN57/CN59)

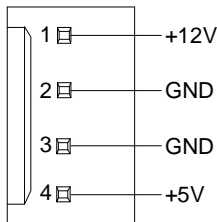

| Pin | Pin Name | Signal Type | Signal Level |
|-----|----------|-------------|--------------|
| 1 | +12V | PWR | +12V |
| 2 | GND | GND | |
| 3 | GND | GND | |
| 4 | +5V | PWR | +5V |

2.4.15 DIO Connector (CN20)

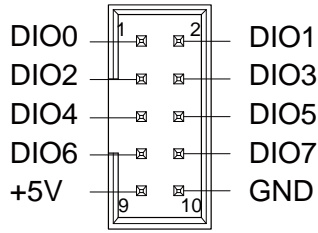

| Pin | Pin Name | Signal Type | Signal Level |
|-----|----------|-------------|--------------|
| 1 | DIO0 | I/O | |
| 2 | DIO1 | I/O | |
| 3 | DIO2 | I/O | |
| 4 | DIO3 | I/O | |
| 5 | DIO4 | I/O | |
| 6 | DIO5 | I/O | |
| 7 | DIO6 | I/O | |
| 8 | DIO7 | I/O | |
| 9 | +5V | PWR | +5V |
| 10 | GND | GND | |

2.4.16 Dual COM Connector RS-232/422/485 (CN22)

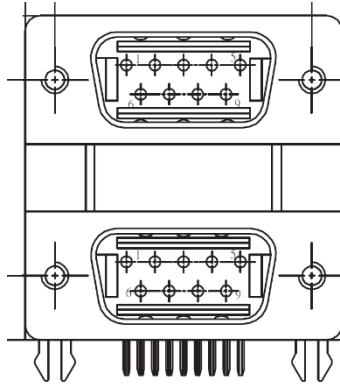

| Pin | Pin Name | Signal Type | RS-422 | RS-485 |
|-----|----------|-------------|-----------|----------|
| 1 | DCD1 | IN | RS422_TX- | RS485_D- |
| 2 | RX1 | IN | RS422_TX+ | RS485_D+ |
| 3 | TX1 | OUT | RS422_RX+ | |
| 4 | DTR1 | OUT | RS422_RX- | |
| 5 | GND | GND | | |
| 6 | DSR1 | IN | | |
| 7 | RTS1 | OUT | | |
| 8 | CTS1 | IN | | |
| 9 | RI1 | IN | | |
| 10 | DCD2 | IN | RS422_TX- | RS485_D- |
| 11 | RX2 | IN | RS422_TX+ | RS485_D- |
| 12 | TX2 | OUT | RS422_RX+ | |
| 13 | DTR2 | OUT | RS422_RX- | |
| 14 | GND | GND | | |
| 15 | DSR2 | IN | | |
| 16 | RTS2 | OUT | | |
| 17 | CTS2 | IN | | |
| 18 | RI2 | IN | | |

2.4.17 USB 2.0 Wafer Box (CN24/CN25/CN26/CN27)

| Pin | Pin Name | Signal Type | Signal Level |
|-----|----------|-------------|--------------|
| 1 | +5V | PWR | +5V |
| 2 | USBD- | DIFF | |
| 3 | USBD+ | DIFF | |
| 4 | GND | GND | |
| 5 | GND | GND | |

2.4.18 Audio Wafer (CN29)

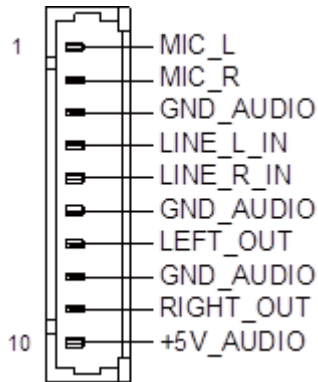

| Pin | Pin Name | Signal Type | Signal Level |
|-----|-----------|-------------|--------------|
| 1 | MIC_L | IN | |
| 2 | MIC_R | IN | |
| 3 | GND_AUDIO | GND | |
| 4 | LINE_L_IN | IN | |
| 5 | LINE_R_IN | IN | |
| 6 | GND_AUDIO | GND | |
| 7 | LEFT_OUT | OUT | |
| 8 | GND_AUDIO | GND | |

| Pin | Pin Name | Signal Type | Signal Level |
|-----|-----------|-------------|--------------|
| 9 | RIGHT_OUT | OUT | |
| 10 | +5V_AUDIO | PWR | +5V |

2.4.19 DC-In Connector (CN30)

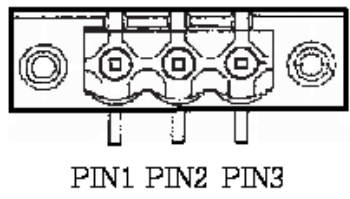

| Pin | Pin Name | Signal Type | Signal Level |
|-----|----------|-------------|--------------|
| 1 | +19-36V | PWR | +19-36V |
| 2 | GND | GND | |
| 3 | NC | | |

2.4.20 M.2 2280 M-Key 1 (CN31)

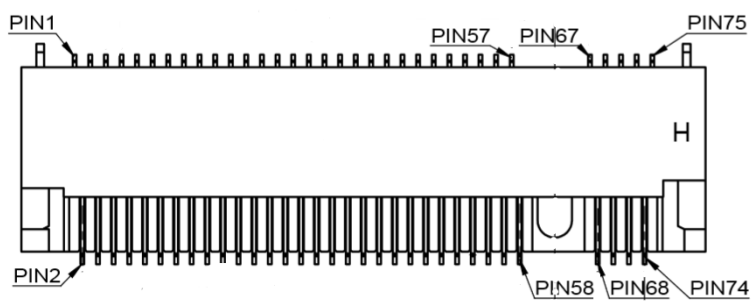

| Pin | Pin Name | Signal Type | Pin | Pin Name | Signal Type | Signal Level |
|-----|-----------|-------------|-----|----------|-------------|--------------|
| 1 | GND | | 2 | +3.3V | PWR | +3.3V |
| 3 | GND | GND | 4 | +3.3V | PWR | +3.3V |
| 5 | PCIE_RXN3 | DIFF | 6 | NC | | |

| Pin | Pin Name | Signal Type | Pin | Pin Name | Signal Type | Signal Level |
|-----|---------------|-------------|-----|-------------|-------------|--------------|
| 7 | PCIE_RXP3 | DIFF | 8 | NC | | |
| 9 | GND | | 10 | NC | | |
| 11 | PCIE_TXN3 | DIFF | 12 | +3.3V | PWR | +3.3V |
| 13 | PCIE_TXP3 | DIFF | 14 | +3.3V | PWR | +3.3V |
| 15 | GND | GND | 16 | +3.3V | PWR | +3.3V |
| 17 | PCIE_RXN2 | DIFF | 18 | +3.3V | PWR | +3.3V |
| 19 | PCIE_RXP2 | DIFF | 20 | NC | | |
| 21 | GND | GND | 22 | NC | | |
| 23 | PCIE_TXN2 | DIFF | 24 | NC | | |
| 25 | PCIE_TXP2 | DIFF | 26 | NC | | |
| 27 | GND | GND | 28 | NC | | |
| 29 | PCIE_RXN1 | DIFF | 30 | NC | | |
| 31 | PCIE_RXP1 | DIFF | 32 | NC | | |
| 33 | GND | GND | 34 | NC | | |
| 35 | PCIE_TXN1 | DIFF | 36 | NC | | |
| 37 | PCIE_TXP1 | DIFF | 38 | DEVSLP | | |
| 39 | GND | GND | 40 | SMB_CLK_M2 | | |
| 41 | PCIE_RXP0 | DIFF | 42 | SMB_DATA_M2 | | |
| 43 | PCIE_RXN0 | DIFF | 44 | NC | | |
| 45 | GND | GND | 46 | NC | | |
| 47 | PCIE_TXN0 | DIFF | 48 | NC | | |
| 49 | PCIE_TXP0 | DIFF | 50 | RESET# | | |
| 51 | GND | GND | 52 | CLKREQ# | | |
| 53 | PCIE_M.2_CLK# | DIFF | 54 | WAKE# | | |
| 55 | PCIE_M.2_CLK | DIFF | 56 | NC | | |
| 57 | GND | GND | 58 | NC | | |

| Pin | Pin Name | Signal Type | Pin | Pin Name | Signal Type | Signal Level |
|-----|----------|-------------|-----|----------|-------------|--------------|
| 67 | NC | | 68 | NC | | |
| 69 | NC | | 70 | +3.3V | PWR | +3.3V |
| 71 | GND | GND | 72 | +3.3V | PWR | +3.3V |
| 73 | GND | GND | 74 | +3.3V | PWR | +3.3V |
| 75 | GND | GND | | | | |

2.4.21 PEG [x16] Slot (CN36)

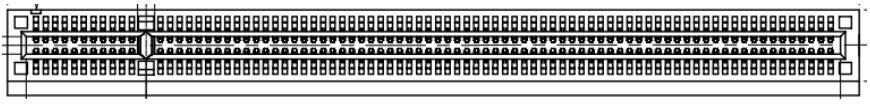

| Pin | Pin Name | Signal Type | Pin | Pin Name | Signal Type | Signal Level |
|-----|-------------------|-------------|-----|----------|-------------|--------------|
| A1 | GND | | B1 | +12V | PWR | +12V |
| A2 | +12V | | B2 | +12V | PWR | +12V |
| A3 | +12V | | B3 | +12V | PWR | +12V |
| A4 | GND | | B4 | GND | GND | |
| A5 | JTAG2 | | B5 | SMB_CLK | | |
| A6 | JTAG3 | | B6 | SMB_DATA | | |
| A7 | JTAG4 | | B7 | GND | GND | |
| A8 | JTAG5 | | B8 | +3.3V | PWR | +3.3V |
| A9 | +3.3V | | B9 | NC | | |
| A10 | +3.3V | | B10 | +3.3A | PWR | +3.3V |
| A11 | RST# | | B11 | WAKE# | | |
| A12 | GND | | B12 | NC | | |
| A13 | PCIE_x16SLOT_C LK | DIFF | B13 | GND | GND | |

| Pin | Pin Name | Signal Type | Pin | Pin Name | Signal Type | Signal Level |
|-----|--------------------|-------------|-----|----------|-------------|--------------|
| A14 | PCIE_x16SLOT_C LK# | DIFF | B14 | PEG_TXP0 | DIFF | |
| A15 | GND | | B15 | PEG_TXN0 | DIFF | |
| A16 | PEG_RXP0 | DIFF | B16 | GND | GND | |
| A17 | PEG_RXN0 | DIFF | B17 | +3.3V | PWR | +3.3V |
| A18 | GND | GND | B18 | GND | GND | |
| A19 | NC | | B19 | PEG_TXP1 | DIFF | |
| A20 | GND | GND | B20 | PEG_TXN1 | DIFF | |
| A21 | PEG_RXP1 | DIFF | B21 | GND | GND | |
| A22 | PEG_RXN1 | DIFF | B22 | GND | GND | |
| A23 | GND | GND | B23 | PEG_TXP2 | DIFF | |
| A24 | GND | GND | B24 | PEG_TXN2 | DIFF | |
| A25 | PEG_RXP2 | DIFF | B25 | GND | GND | |
| A26 | PEG_RXN2 | DIFF | B26 | GND | GND | |
| A27 | GND | GND | B27 | PEG_TXP3 | DIFF | |
| A28 | GND | GND | B28 | PEG_TXN3 | DIFF | |
| A29 | PEG_RXP3 | DIFF | B29 | GND | GND | |
| A30 | PEG_RXN3 | DIFF | B30 | NC | | |
| A31 | GND | GND | B31 | +3.3V | PWR | +3.3V |
| A32 | NC | | B32 | GND | GND | |
| A33 | NC | | B33 | PEG_TXP4 | DIFF | |
| A34 | GND | GND | B34 | PEG_TXN4 | DIFF | |
| A35 | PEG_RXP4 | DIFF | B35 | GND | GND | |
| A36 | PEG_RXN4 | DIFF | B36 | GND | GND | |
| A37 | GND | GND | B37 | PEG_TXP5 | DIFF | |
| A38 | GND | GND | B38 | PEG_TXN5 | DIFF | |
| A39 | PEG_RXP5 | DIFF | B39 | GND | GND | |
| A40 | PEG_RXN5 | DIFF | B40 | GND | GND | |
| A41 | GND | GND | B41 | PEG_TXP6 | DIFF | |

| Pin | Pin Name | Signal Type | Pin | Pin Name | Signal Type | Signal Level |
|-----|-----------|-------------|-----|-----------|-------------|--------------|
| A42 | GND | GND | B42 | PEG_TXN6 | DIFF | |
| A43 | PEG_RXP6 | DIFF | B43 | GND | GND | |
| A44 | PEG_RXN6 | DIFF | B44 | GND | GND | |
| A45 | GND | GND | B45 | PEG_TXP7 | DIFF | |
| A46 | GND | GND | B46 | PEG_TXN7 | DIFF | |
| A47 | PEG_RXP7 | DIFF | B47 | GND | GND | |
| A48 | PEG_RXN7 | DIFF | B48 | +3.3V | PWR | +3.3V |
| A49 | GND | GND | B49 | GND | GND | |
| A50 | NC | | B50 | PEG_TXP8 | DIFF | |
| A51 | GND | GND | B51 | PEG_TXN8 | DIFF | |
| A52 | PEG_RXP8 | DIFF | B52 | GND | GND | |
| A53 | PEG_RXN8 | DIFF | B53 | GND | GND | |
| A54 | GND | GND | B54 | PEG_TXP9 | DIFF | |
| A55 | GND | GND | B55 | PEG_TXN9 | DIFF | |
| A56 | PEG_RXP9 | DIFF | B56 | GND | GND | |
| A57 | PEG_RXN9 | DIFF | B57 | GND | GND | |
| A58 | GND | GND | B58 | PEG_TXP10 | DIFF | |
| A59 | GND | GND | B59 | PEG_TXN10 | DIFF | |
| A60 | PEG_RXP10 | DIFF | B60 | GND | GND | |
| A61 | PEG_RXN10 | DIFF | B61 | GND | GND | |
| A62 | GND | GND | B62 | PEG_TXP11 | DIFF | |
| A63 | GND | GND | B63 | PEG_TXN11 | DIFF | |
| A64 | PEG_RXP11 | DIFF | B64 | GND | GND | |
| A65 | PEG_RXN11 | DIFF | B65 | GND | GND | |
| A66 | GND | GND | B66 | PEG_TXP12 | DIFF | |
| A67 | GND | GND | B67 | PEG_TXN12 | DIFF | |
| A68 | PEG_RXP12 | DIFF | B68 | GND | GND | |
| A69 | PEG_RXN12 | DIFF | B69 | GND | GND | |

| Pin | Pin Name | Signal Type | Pin | Pin Name | Signal Type | Signal Level |
|-----|-----------|-------------|-----|-----------|-------------|--------------|
| A70 | GND | GND | B70 | PEG_TXP13 | DIFF | |
| A71 | GND | GND | B71 | PEG_TXN13 | DIFF | |
| A72 | PEG_RXP13 | DIFF | B72 | GND | GND | |
| A73 | PEG_RXN13 | DIFF | B73 | GND | GND | |
| A74 | GND | GND | B74 | PEG_TXP14 | DIFF | |
| A75 | GND | GND | B75 | PEG_TXN14 | DIFF | |
| A76 | PEG_RXP14 | DIFF | B76 | GND | GND | |
| A77 | PEG_RXN14 | DIFF | B77 | GND | GND | |
| A78 | GND | GND | B78 | PEG_TXP15 | DIFF | |
| A79 | GND | GND | B79 | PEG_TXN15 | DIFF | |
| A80 | PEG_RXP15 | DIFF | B80 | GND | GND | |
| A81 | PEG_RXN15 | DIFF | B81 | +3.3V | PWR | +3.3V |
| A82 | GND | GND | B82 | NC | | |

2.4.22 Mini PCIe Socket (CN37)

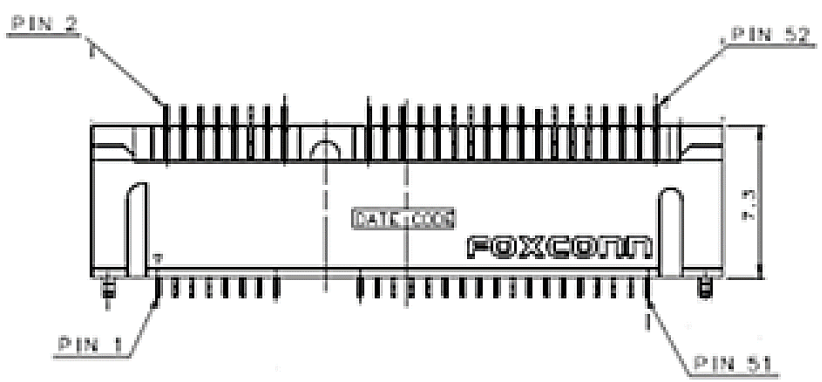

| Pin | Pin Name | Signal Type | Signal Level |
|-----|------------|-------------|--------------|
| 1 | PCIE_WAKE# | IN | |
| 2 | +3.3VSB | PWR | +3.3V |
| 3 | NC | | |

| Pin | Pin Name | Signal Type | Signal Level |
|-----|---------------|-------------|--------------|
| 4 | GND | GND | |
| 5 | NC | | |
| 6 | +1.5V | PWR | +1.5V |
| 7 | PCIE_CLK_REQ# | IN | N/A |
| 8 | UIM_PWR | PWR | |
| 9 | GND | GND | |
| 10 | UIM_DATA | I/O | |
| 11 | PCIE_REF_CLK- | DIFF | N/A |
| 12 | UIM_CLK | IN | |
| 13 | PCIE_REF_CLK+ | DIFF | N/A |
| 14 | UIM_RST | IN | |
| 15 | GND | GND | |
| 16 | UIM_VPP | PWR | |
| 17 | NC | | |
| 18 | GND | GND | |
| 19 | NC | | |
| 20 | W_DISABLE# | OUT | +3.3V |
| 21 | GND | GND | |
| 22 | PCIE_RST# | OUT | +3.3V |
| 23 | PCIE_RX- | DIFF | N/A |
| 24 | +3.3VSB | PWR | +3.3V |
| 25 | PCIE_RX+ | DIFF | N/A |
| 26 | GND | GND | |
| 27 | GND | GND | |
| 28 | +1.5V | PWR | +1.5V |
| 29 | GND | GND | |
| 30 | SMB_CLK | I/O | +3.3V |
| 31 | PCIE_TX- | DIFF | N/A |
| 32 | SMB_DATA | I/O | +3.3V |

| Pin | Pin Name | Signal Type | Signal Level |
|-----|----------|-------------|--------------|
| 33 | PCIE_TX+ | DIFF | N/A |
| 34 | GND | GND | |
| 35 | GND | GND | |
| 36 | USB_D- | DIFF | |
| 37 | GND | GND | |
| 38 | USB_D+ | DIFF | |
| 39 | +3.3VSB | PWR | +3.3V |
| 40 | GND | GND | |
| 41 | +3.3VSB | PWR | +3.3V |
| 42 | NC | | |
| 43 | GND | GND | |
| 44 | NC | | |
| 45 | NC | | |
| 46 | NC | | |
| 47 | NC | | |
| 48 | +1.5V | PWR | +1.5V |
| 49 | NC | | |
| 50 | GND | GND | |
| 51 | NC | | |
| 52 | +3.3VSB | PWR | +3.3V |

2.4.23 2X4 PEG Power (CN50/CN51/CN68)

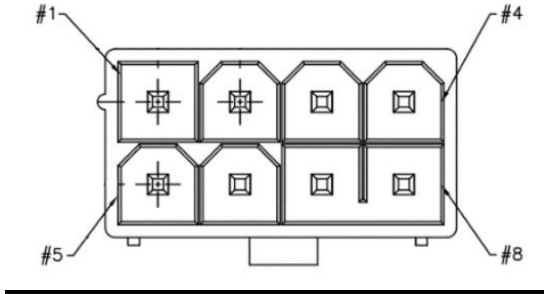

| Pin | Pin Name | Signal Type | Signal Level |
|-----|----------|-------------|--------------|
| 1 | +V12_GPU | PWR | +12V |
| 2 | +V12_GPU | PWR | +12V |
| 3 | +V12_GPU | PWR | +12V |
| 4 | GND | GND | |
| 5 | GND | GND | |
| 6 | GND | GND | |
| 7 | GND | GND | |
| 8 | GND | GND | |

2.4.24 COM Port 1 Wafer Box (Optional) (CN52)

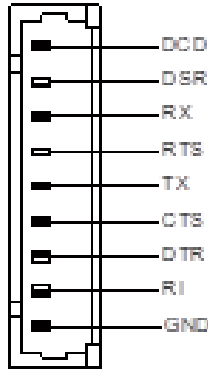

| Pin | Pin Name | Signal Type | RS-422 | RS-485 |
|-----|----------|-------------|-----------|--------|
| 1 | DCD | IN | RS422_TX- | D- |
| 2 | DSR | IN | | |
| 3 | RX | IN | RS422_TX+ | D+ |
| 4 | RTS | OUT | | |
| 5 | TX | OUT | RS422_RX+ | |
| 6 | CTS | IN | | |
| 7 | DTR | OUT | RS422_RX- | |
| 8 | RI | IN | | |
| 9 | GND | GND | | |

2.4.25 COM Port 2 Wafer Box (Optional) (CN53)

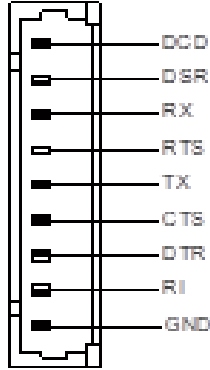

| Pin | Pin Name | Signal Type | RS-422 | RS-485 |
|-----|----------|-------------|-----------|--------|
| 1 | DCD | IN | RS422_TX- | D- |
| 2 | DSR | IN | | |
| 3 | RX | IN | RS422_TX+ | D+ |
| 4 | RTS | OUT | | |
| 5 | TX | OUT | RS422_RX+ | |
| 6 | CTS | IN | | |
| 7 | DTR | OUT | RS422_RX- | |
| 8 | RI | IN | | |

2.4.26 COM Port 3 Wafer Box (Optional) (CN54)

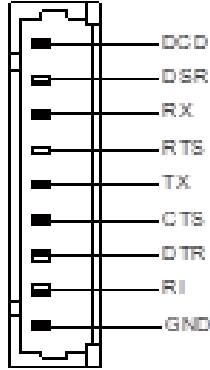

| Pin | Pin Name | Signal Type | RS-422 | RS-485 |
|-----|----------|-------------|-----------|--------|
| 1 | DCD | IN | RS422_TX- | D- |
| 2 | DSR | IN | | |
| 3 | RX | IN | RS422_TX+ | D+ |
| 4 | RTS | OUT | | |
| 5 | TX | OUT | RS422_RX+ | |
| 6 | CTS | IN | | |
| 7 | DTR | OUT | RS422_RX- | |
| 8 | RI | IN | | |
| 9 | GND | GND | | |

2.4.27 COM Port 4 Wafer Box (Optional) (CN55)

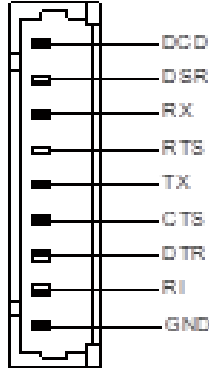

| Pin | Pin Name | Signal Type | RS-422 | RS-485 |
|-----|----------|-------------|-----------|--------|
| 1 | DCD | IN | RS422_TX- | D- |
| 2 | DSR | IN | | |
| 3 | RX | IN | RS422_TX+ | D+ |
| 4 | RTS | OUT | | |
| 5 | TX | OUT | RS422_RX+ | |
| 6 | CTS | IN | | |
| 7 | DTR | OUT | RS422_RX- | |
| 8 | RI | IN | | |
| 9 | GND | GND | | |

2.4.28 System Fan Connector (CN60/CN65)

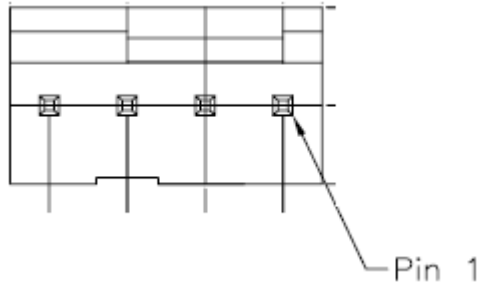

| Pin | Pin Name | Signal Type | Signal Level |
|-----|----------|-------------|--------------|
| 1 | GND | GND | |
| 2 | +V12S | PWR | +12V |
| 3 | FAN_PWM | OUT | |
| 4 | FAN_CTL | OUT | |

2.4.29 COM Port 5 Wafer Box (Optional) (CN61)

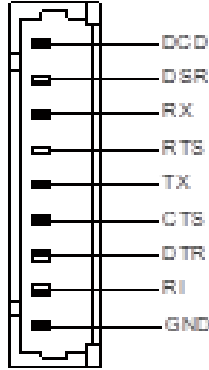

| Pin | Pin Name | Signal Type | RS-422 | RS-485 |
|-----|----------|-------------|-----------|--------|
| 1 | DCD | IN | RS422_TX- | D- |
| 2 | DSR | IN | | |
| 3 | RX | IN | RS422_TX+ | D+ |
| 4 | RTS | OUT | | |
| 5 | TX | OUT | RS422_RX+ | |
| 6 | CTS | IN | | |
| 7 | DTR | OUT | RS422_RX- | |
| 8 | RI | IN | | |
| 9 | GND | GND | | |

2.4.30 COM Port 6 Wafer Box (Optional) (CN62)

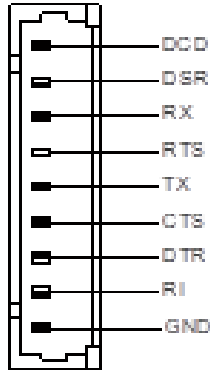

| Pin | Pin Name | Signal Type | RS-422 | RS-485 |
|-----|----------|-------------|-----------|--------|
| 1 | DCD | IN | RS422_TX- | D- |
| 2 | DSR | IN | | |
| 3 | RX | IN | RS422_TX+ | D+ |
| 4 | RTS | OUT | | |
| 5 | TX | OUT | RS422_RX+ | |
| 6 | CTS | IN | | |
| 7 | DTR | OUT | RS422_RX- | |
| 8 | RI | IN | | |
| 9 | GND | GND | | |

2.4.31 M.2 2280 M-Key 2 (CN63)

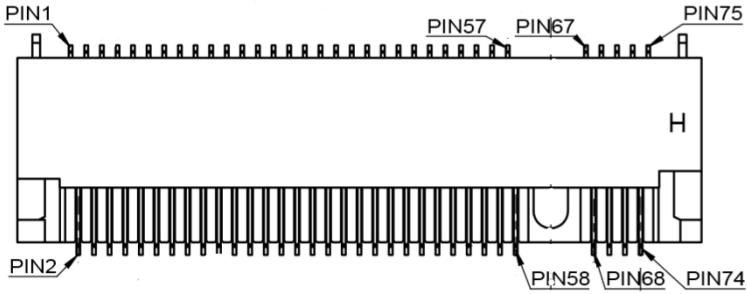

| Pin | Pin Name | Signal Type | Pin | Pin Name | Signal Type | Signal Level |
|-----|-----------|-------------|-----|----------|-------------|--------------|
| 1 | GND | GND | 2 | +3.3V | PWR | +3.3V |
| 3 | GND | GND | 4 | +3.3V | PWR | +3.3V |
| 5 | PCIE_RXN3 | DIFF | 6 | NC | | |
| 7 | PCIE_RXP3 | DIFF | 8 | NC | | |
| 9 | GND | | 10 | NC | | |
| 11 | PCIE_TXN3 | DIFF | 12 | +3.3V | PWR | +3.3V |
| 13 | PCIE_TXP3 | DIFF | 14 | +3.3V | PWR | +3.3V |
| 15 | GND | | 16 | +3.3V | PWR | +3.3V |
| 17 | PCIE_RXN2 | DIFF | 18 | +3.3V | PWR | +3.3V |
| 19 | PCIE_RXP2 | DIFF | 20 | NC | | |
| 21 | GND | | 22 | NC | | |
| 23 | PCIE_TXN2 | DIFF | 24 | NC | | |
| 25 | PCIE_TXP2 | DIFF | 26 | NC | | |
| 27 | GND | GND | 28 | NC | | |
| 29 | PCIE_RXN1 | DIFF | 30 | NC | | |
| 31 | PCIE_RXP1 | DIFF | 32 | NC | | |
| 33 | GND | GND | 34 | NC | | |
| 35 | PCIE_TXN1 | DIFF | 36 | NC | | |
| 37 | PCIE_TXP1 | DIFF | 38 | DEVSLP | IN | +3.3V |

| Pin | Pin Name | Signal Type | Pin | Pin Name | Signal Type | Signal Level |
|-----|---------------|-------------|-----|-------------|-------------|--------------|
| 39 | GND | GND | 40 | SMB_CLK_M2 | | +1.8V |
| 41 | PCIE_RXP0 | DIFF | 42 | SMB_DATA_M2 | | +1.8V |
| 43 | PCIE_RXN0 | DIFF | 44 | NC | | |
| 45 | GND | GND | 46 | NC | | |
| 47 | PCIE_TXN0 | DIFF | 48 | NC | | |
| 49 | PCIE_TXP0 | DIFF | 50 | RESET# | IN | +3.3V |
| 51 | GND | PWR | 52 | CLKREQ# | OUT | +3.3V |
| 53 | PCIE_M.2_CLK# | OUT | 54 | WAKE# | OUT | +3.3V |
| 55 | PCIE_M.2_CLK | OUT | 56 | NC | | |
| 57 | GND | GND | 58 | NC | | |
| | | | | | | |
| | | | | | | |
| | | | | | | |
| | | | | | | |
| 67 | NC | | 68 | NC | | |
| 69 | NC | | 70 | +3.3V | PWR | +3.3V |
| 71 | GND | GND | 72 | +3.3V | PWR | +3.3V |
| 73 | GND | GND | 74 | +3.3V | PWR | +3.3V |
| 75 | GND | GND | | | | |

2.4.32 Dual HDMI (CN64)

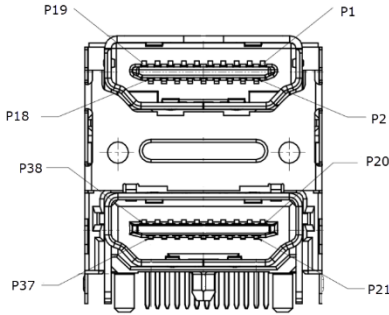

| Pin | Pin Name | Signal Type | Signal Level |
|-----|---------------|-------------|--------------|
| P1 | HDMI1_DATA2_P | DIFF | |
| P2 | GND | GND | |
| P3 | HDMI1_DATA2_N | DIFF | |
| P4 | HDMI1_DATA1_P | DIFF | |
| P5 | GND | GND | |
| P6 | HDMI1_DATA1_N | DIFF | |
| P7 | HDMI1_DATA0_P | DIFF | |
| P8 | GND | GND | |
| P9 | HDMI1_DATA0_n | DIFF | |
| P10 | HDMI1_CLK_P | DIFF | |
| P11 | GND | GND | |
| P12 | HDMI1_CLK_N | DIFF | |
| P13 | CEC | | 3.3V |
| P14 | NC | | |
| P15 | HDMI1_SCL | | |
| P16 | HDMI1_SDA | | |
| P17 | GND | GND | |
| P18 | +V5S_HDMI_CON | PWR | 5V |

| Pin | Pin Name | Signal Type | Signal Level |
|-----|----------------|-------------|--------------|
| P19 | HDMI1_HPD_CONN | | |
| P20 | HDMI2_DATA2_P | DIFF | |
| P21 | GND | GND | |
| P22 | HDMI2_DATA2_N | DIFF | |
| P23 | HDMI2_DATA1_P | DIFF | |
| P24 | GND | GND | |
| P25 | HDMI2_DATA1_N | DIFF | |
| P26 | HDMI2_DATA0_P | DIFF | |
| P27 | GND | GND | |
| P28 | HDMI2_DATA0_n | DIFF | |
| P29 | HDMI2_CLK_P | DIFF | |
| P30 | GND | GND | |
| P31 | HDMI2_CLK_N | DIFF | |
| P32 | CEC | | 3.3V |
| P33 | NC | | |
| P34 | HDMI2_SCL | | |
| P35 | HDMI2_SDA | | |
| P36 | GND | GND | |
| P37 | +V5S_HDMI_CON | PWR | 5V |
| P38 | HDMI2_HPD_CONN | | |

2.4.33 Mini PCIe Nano SIM Card (CN67)

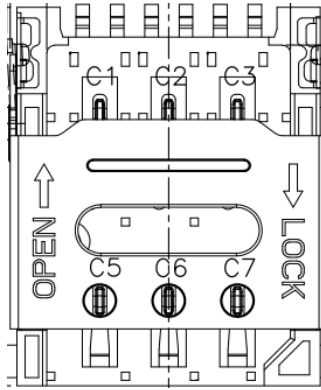

| Pin | Pin Name | Signal Type | Signal Level |
|-----|----------------|-------------|--------------|
| 1 | UIM_PWR | PWR | |
| 2 | NANO_UIM_RESET | IN | |
| 3 | NANO_UIM_CLK | IN | |
| 4 | GND | GND | |
| 5 | NANO_UIM_VPP | PWR | |
| 6 | NANO_UIM_DATA | I/O | |

2.4.34 CPU Fan Connector (CN69)

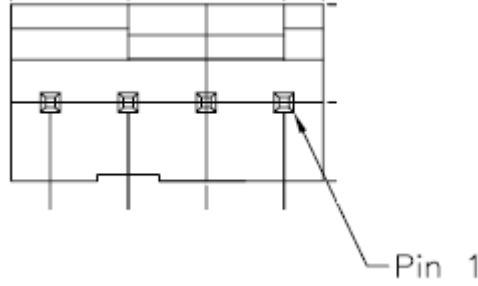

| Pin | Pin Name | Signal Type | Signal Level |
|-----|----------|-------------|--------------|
| 1 | GND | GND | |
| 2 | +V12S | PWR | +12V |
| 3 | FAN_PWM | OUT | |
| 4 | FAN_CTL | OUT | |

2.4.35 Battery Connector (BAT1)

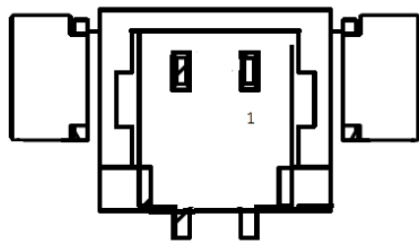

| Pin | Pin Name | Signal Type | Signal Level |
|-----|-----------|-------------|--------------|
| 1 | +3.3V_RTC | PWR | 3.3V |
| 2 | GND | GND | |

2.5 CPU Installation

Step 1: Remove the chassis cover by unscrewing the six (6) retention screws.

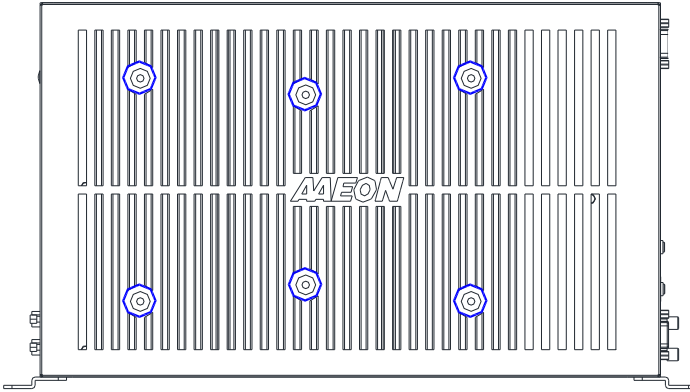

Step 2: You will see the CPU socket as in the diagram below. Install the CPU. Ensure you have also placed the thermal pad as shown below.

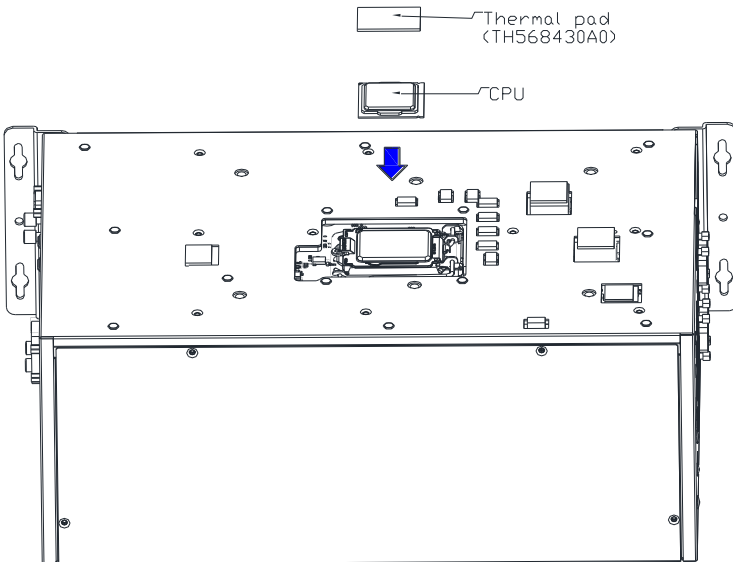

Step 3: Replace the cover and secure with the six (6) screws removed in Step 1.

2.6 SATA Installation

Step 1: Unscrew the two (2) retractable screws from the SATA drive.

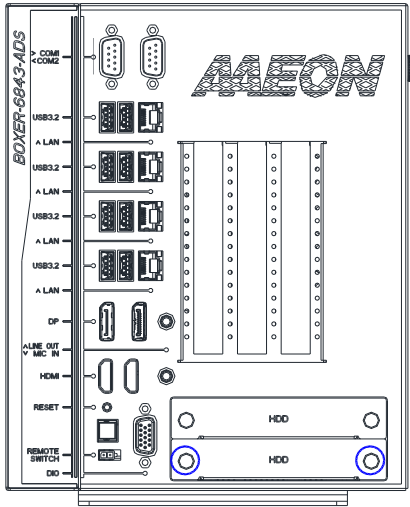

Step 2: Remove the four (4) screws from the 2.5" SATA drive bay, insert your SATA module, then reattach the screws to secure the drive to the drive bay.

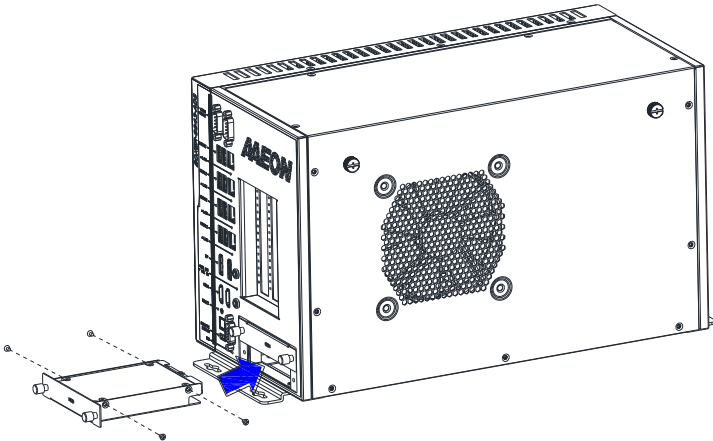

Step 3: Reinsert the drive bay and secure the loosened retractable screws.

2.7 Expansion Module and Mini Card Location

Note the location of the system's M.2 and Mini Card expansion slots.

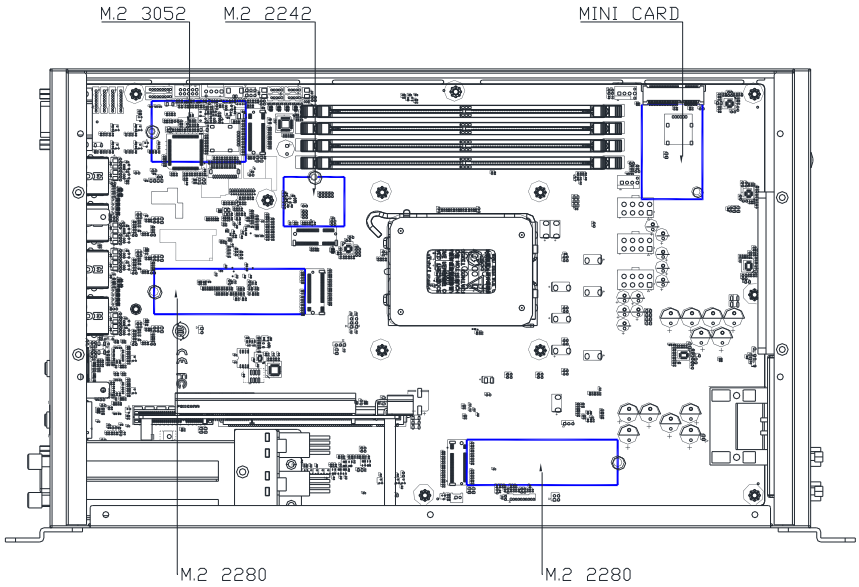

Follow standard installation M.2 module and Mini Card installation procedures. For more information regarding slot placement, please refer to section 2.2.

2.8 RAM Module Installation

Before you begin, make sure you have the RAM module(s) you wish to install, along with thermal pads for each.

Step 1: Remove the four (4) screws on the chassis side panel.

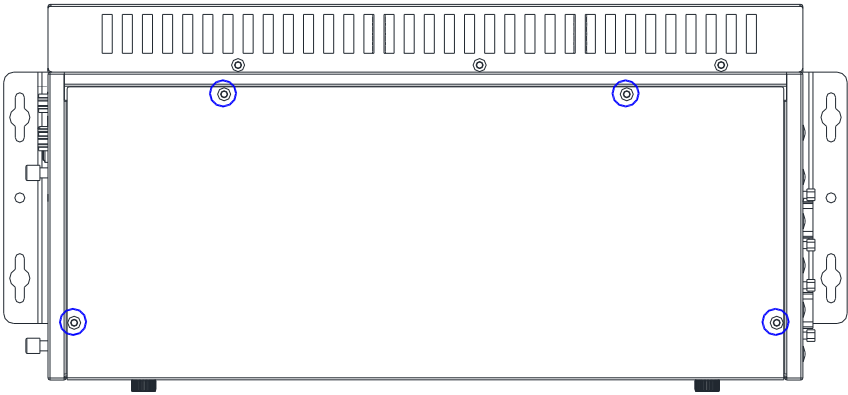

Step 2: Remove the seven (7) screws on the chassis cover.

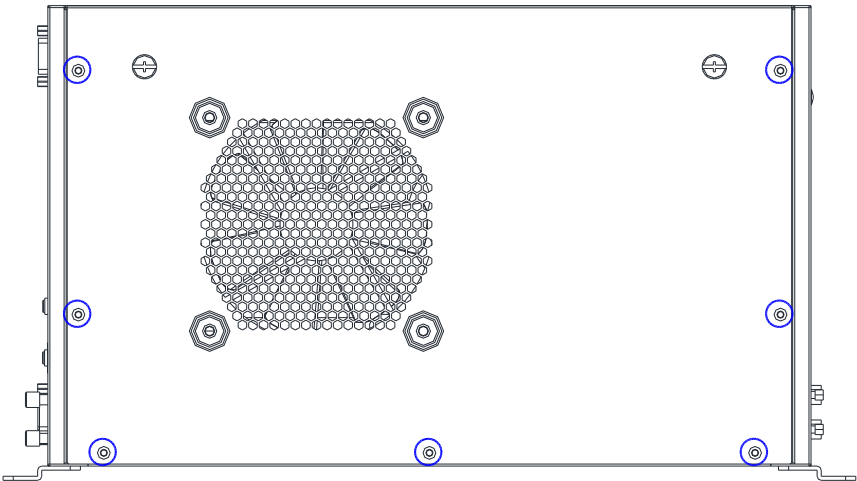

Step 3: The BOXER-6843-ADS contains four (4) U-DIMM slots, as shown below.

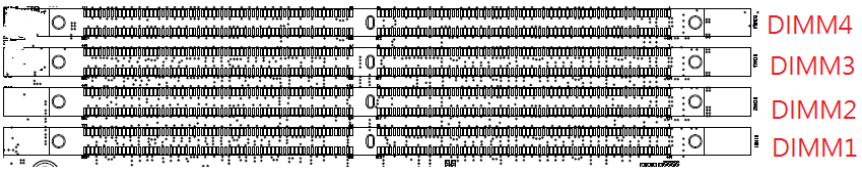

It is important to note that in order to install the RAM modules required, slots must be populated in specific configurations depending on the slots being populated. Please see below for the appropriate module pairings.

| DIMM | DIMM1 | DIMM2 | DIMM3 | DIMM4 |
|--------|----------|----------|----------|----------|
| 1 DIMM | | Inserted | | Inserted |
| 2 DIMM | Inserted | Inserted | | |
| 2 DIMM | | | Inserted | Inserted |
| 4 DIMM | Inserted | Inserted | Inserted | Inserted |

If installing 1 RAM module, use DIMM2 **or** DIMM4.

If installing 2 RAM modules, the following pairings are advised:

- DIMM2 and DIMM4



- DIMM3 and DIMM4



- DIMM1 and DIMM2



If installing four RAM modules, populate all four DIMM slots.

Installing RAM modules in a configuration contrary to that shown above may result in lower performance.

Step 4: Insert the required RAM module(s) into the appropriate slot(s) at approximately a 45° angle, then gently press down until secured, as below.

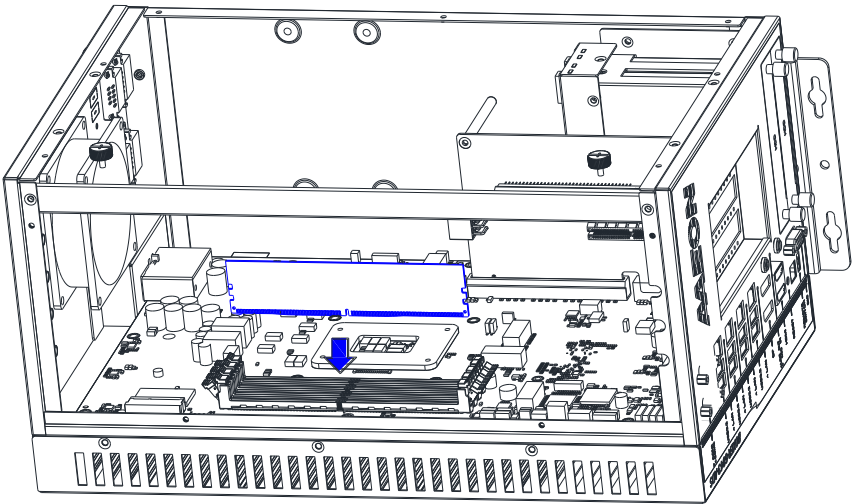

Chapter 3

AMI BIOS Setup

3.1 System Test and Initialization

The system uses certain routines to perform testing and initialization. If an error, fatal or non-fatal, is encountered, a few short beeps or an error message will be outputted. The board can usually continue the boot up sequence with non-fatal errors.

The system configuration verification routines check the current system configuration against the values stored in the CMOS memory. If they do not match, an error message will be outputted, in which case you will need to run the BIOS setup program to set the configuration information in memory.

There are three situations in which you will need to change the CMOS settings:

- You are starting your system for the first time
- You have changed your system's hardware
- The CMOS memory has lost power and the configuration information is erased

The system's CMOS memory uses a backup battery for data retention, which is to be replaced once emptied.

3.2 AMI BIOS Setup

The AMI BIOS ROM has a pre-installed Setup program that allows users to modify basic system configurations, which is stored in the battery-backed CMOS RAM and BIOS NVRAM so that the information is retained when the power is turned off.

To enter BIOS Setup, press or <F2> immediately while your computer is powering up.

The function for each interface can be found below.

Main – Date and time can be set here. Press <Tab> to switch between date elements

Advanced – Enable/ Disable boot option for legacy network devices

System I/O – Enable/ Disable system I/O device

Boot – Enable/ Disable quiet Boot Option

Security – The setup administrator password can be set here

Save & Exit – Save your changes and exit the program

MEBx – Intel® Management Engine BIOS Extension.

3.3 Setup Submenu: Main

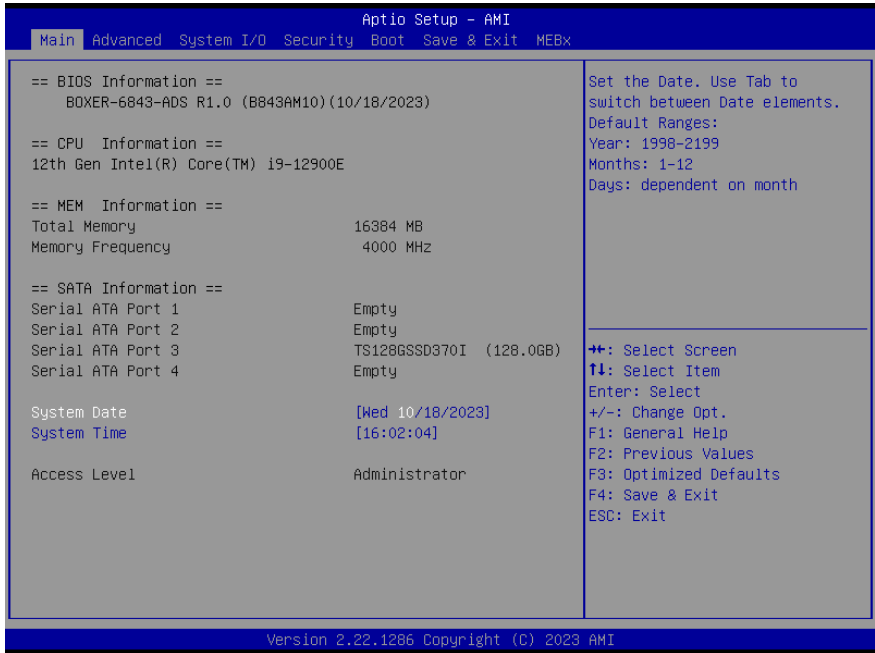

3.4 Setup Submenu: Advanced



3.4.1 CPU Configuration

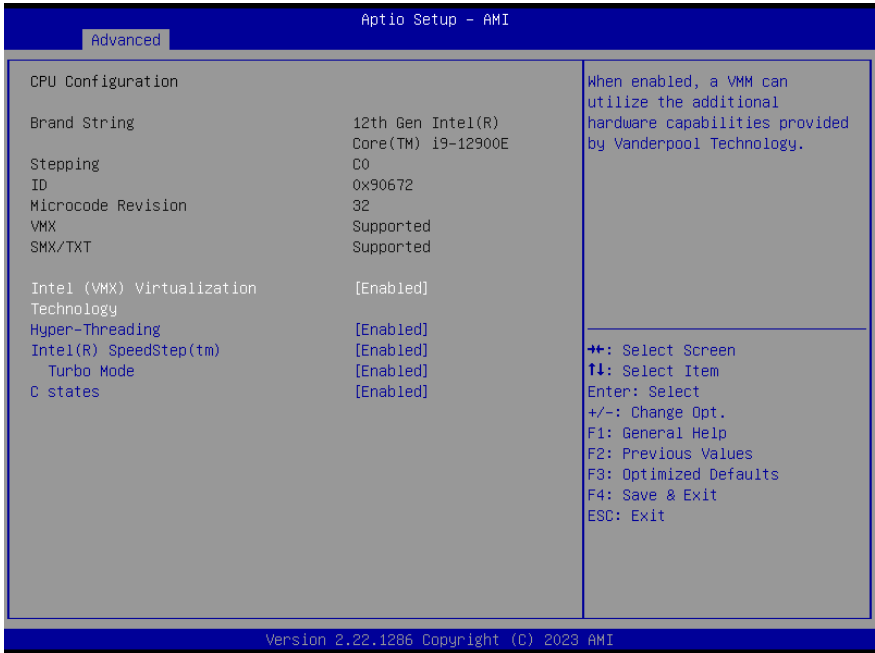

| Options Summary | | |
|---|----------|-----------------------------------|
| Intel (VMX)Virtualization Technology | Disabled | |
| | Enabled | Optimal Default, Failsafe Default |
| When enabled, a VMM can utilize the additional hardware capabilities provided by Vanderpool Technology. | | |
| Hyper-Threading | Disabled | |
| | Enabled | Optimal Default, Failsafe Default |
| Enable or Disable Hyper-Threading Technology. | | |
| Intel® SpeedStep™ | Disabled | |
| | Enabled | Optimal Default, Failsafe Default |
| Allows more than two frequency ranges to be supported. | | |
| Turbo Mode | Disabled | |
| | Enabled | Optimal Default, Failsafe Default |
| Enable/Disable processor Turbo Mode (requires EMTM enabled too). AUTO means enabled. | | |

Options Summary

| | | |
|----------|----------|-----------------------------------|
| C states | Disabled | |
| | Enabled | Optimal Default, Failsafe Default |

Enable/Disable CPU Power Management. Allows CPU to go to C states when it's not 100% utilized.

3.4.2 Memory Configuration

Aptio Setup - AMI

Advanced

Memory Configuration

| | |
|-------------------|--------------------------|
| Total Memory | 16384 MB |
| Memory Frequency | 4000 MHz |
| tCL-tRCD-tRP-tRAS | 32-32-32-64 |
| MC 0 Ch 0 DIMM 0 | Populated & Enabled |
| Size | 16384 MB (DDR5) |
| MC 0 Ch 0 DIMM 1 | Not Populated / Disabled |
| MC 1 Ch 0 DIMM 0 | Not Populated / Disabled |
| MC 1 Ch 0 DIMM 1 | Not Populated / Disabled |

++: Select Screen
 F1: Select Item
 Enter: Select
 +/-: Change Opt.
 F1: General Help
 F2: Previous Values
 F3: Optimized Defaults
 F4: Save & Exit
 ESC: Exit

Version 2.22.1286 Copyright (C) 2023 AMI

3.4.3 PCH-FW Configuration

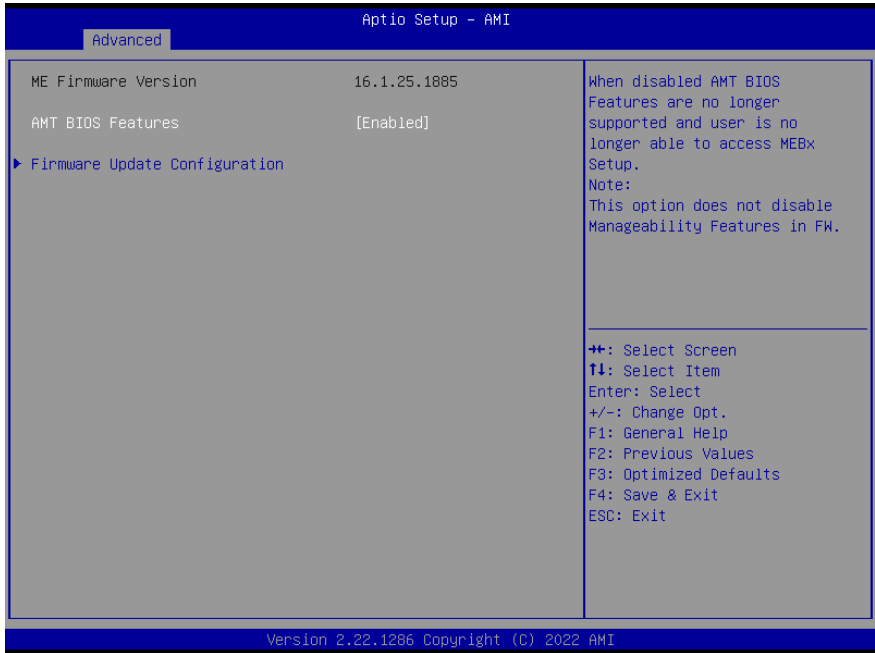

| Options Summary | | |
|--|----------|-----------------------------------|
| AMT BIOS Features | Enabled | Optimal Default, Failsafe Default |
| | Disabled | |
| <p>When disabled AMT BIOS Features are no longer supported and user is no longer able to access MEBx Setup.</p> <p>Note: This option does not disable Manageability Features in FW.</p> | | |

3.4.3.1 Firmware Update Configuration



| Options Summary | | |
|---|----------|-----------------------------------|
| Me FW Image Re-Flash | Enabled | |
| | Disabled | Optimal Default, Failsafe Default |
| Enabled/ Disable Me FW Image Re-Flash function. | | |
| FW Update | Enabled | |
| | Disabled | Optimal Default, Failsafe Default |
| Enabled/ Disable Me FW Update function. | | |

3.4.4 Hardware Monitor

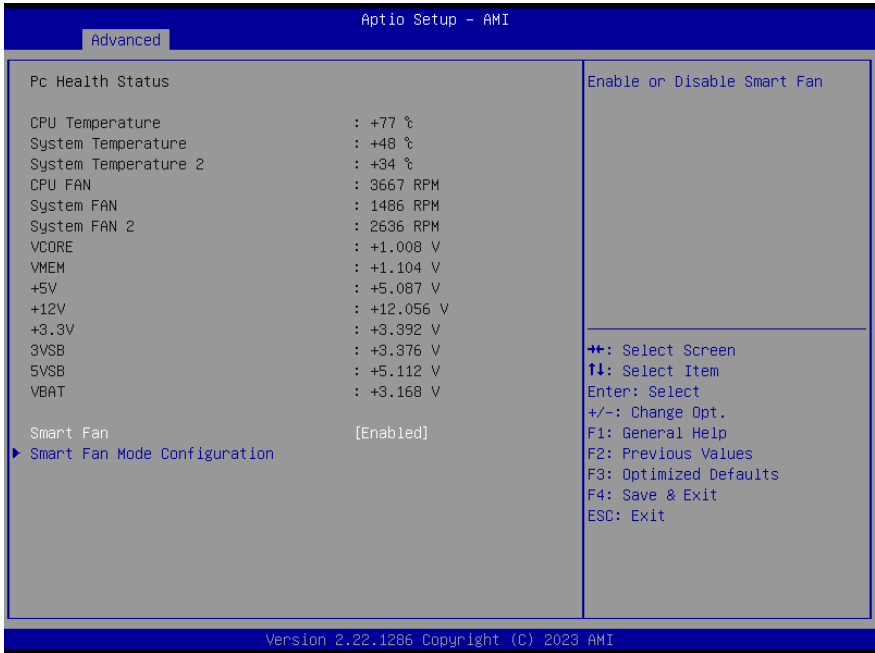

| Options Summary | | |
|------------------------------|----------|-----------------------------------|
| Smart Fan | Enabled | Optimal Default, Failsafe Default |
| | Disabled | |
| Enable or Disable Smart Fan. | | |

3.4.4.1 Smart Fan Mode Configuration

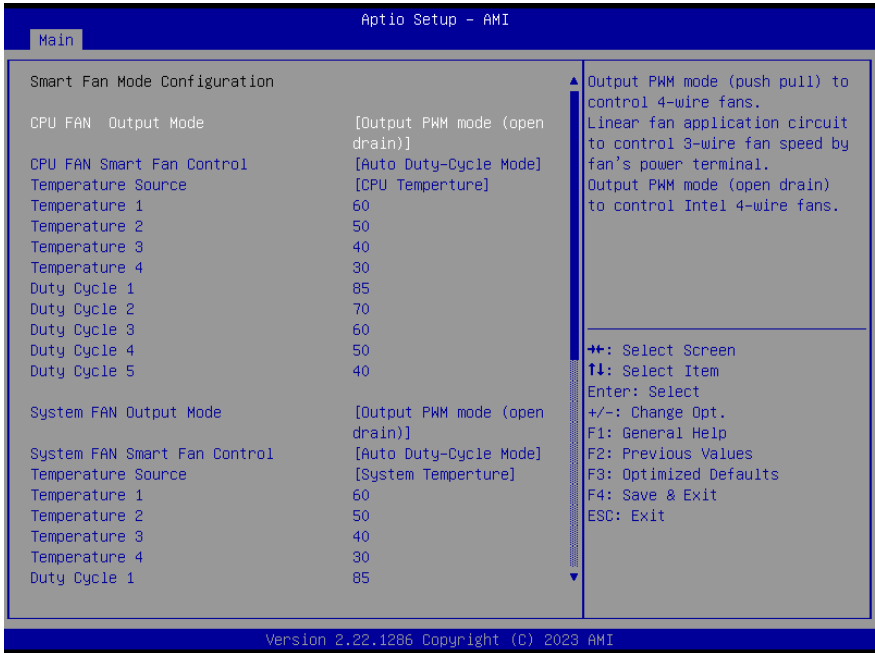

| Options Summary | | |
|--|------------------------------|-----------------------------------|
| CPU FAN Output Mode | Output PWM mode (open drain) | Optimal Default, Failsafe Default |
| | Linear Fan Application | |
| | Output PWM mode (push pull) | |
| Output PWM mode (push pull) to control 4-wire fans. Linear fan application circuit to control 3-wire fan speed by fan's power terminal. Output PWM mode (open drain) to control Intel 4-wire fans. | | |
| CPU Fan Smart Fan Control | Manual Duty Mode | |
| | Auto Duty-Cycle Mode | Optimal Default, Failsafe Default |
| Smart Fan Mode Select. | | |
| Temperature Source | CPU Temperature | Optimal Default, Failsafe Default |
| | System Temperature | |
| | System Temperature 2 | |
| Select the monitored temperature source for this fan. | | |

| Options Summary | | |
|--|------------------------------|-----------------------------------|
| Temperature 1 | 60 | Optimal Default, Failsafe Default |
| Temperature 2 | 50 | Optimal Default, Failsafe Default |
| Temperature 3 | 40 | Optimal Default, Failsafe Default |
| Temperature 4 | 30 | Optimal Default, Failsafe Default |
| Duty Cycle 1 | 85 | Optimal Default, Failsafe Default |
| Duty Cycle 2 | 70 | Optimal Default, Failsafe Default |
| Duty Cycle 3 | 60 | Optimal Default, Failsafe Default |
| Duty Cycle 4 | 50 | Optimal Default, Failsafe Default |
| Duty Cycle 5 | 40 | Optimal Default, Failsafe Default |
| Auto fan speed control. Fan speed will follow different temperature by different duty cycle 1-100 | | |
| System FAN Output Mode | Output PWM mode (open drain) | Optimal Default, Failsafe Default |
| | Linear Fan Application | |
| | Output PWM mode (push pull) | |
| Output PWM mode (push pull) to control 4-wire fans. Linear fan application circuit to control 3-wire fan speed by fan's power terminal. Output PWM mode (open drain) to control Intel 4-wire fans. | | |
| System Fan Smart Fan Control | Manual Duty Mode | |
| | Auto Duty-Cycle Mode | Optimal Default, Failsafe Default |
| Smart Fan Mode Select. | | |
| Temperature Source | CPU Temperature | |
| | System Temperature | Optimal Default, Failsafe Default |
| | System Temperature 2 | |
| Select the monitored temperature source for this fan. | | |
| Temperature 1 | 60 | Optimal Default, Failsafe Default |
| Temperature 2 | 50 | Optimal Default, Failsafe Default |
| Temperature 3 | 40 | Optimal Default, Failsafe Default |
| Temperature 4 | 30 | Optimal Default, Failsafe Default |
| Duty Cycle 1 | 85 | Optimal Default, Failsafe Default |
| Duty Cycle 2 | 70 | Optimal Default, Failsafe Default |
| Duty Cycle 3 | 60 | Optimal Default, Failsafe Default |
| Duty Cycle 4 | 50 | Optimal Default, Failsafe Default |
| Duty Cycle 5 | 40 | Optimal Default, Failsafe Default |
| Auto fan speed control. Fan speed will follow different temperature by different duty cycle 1-100. | | |

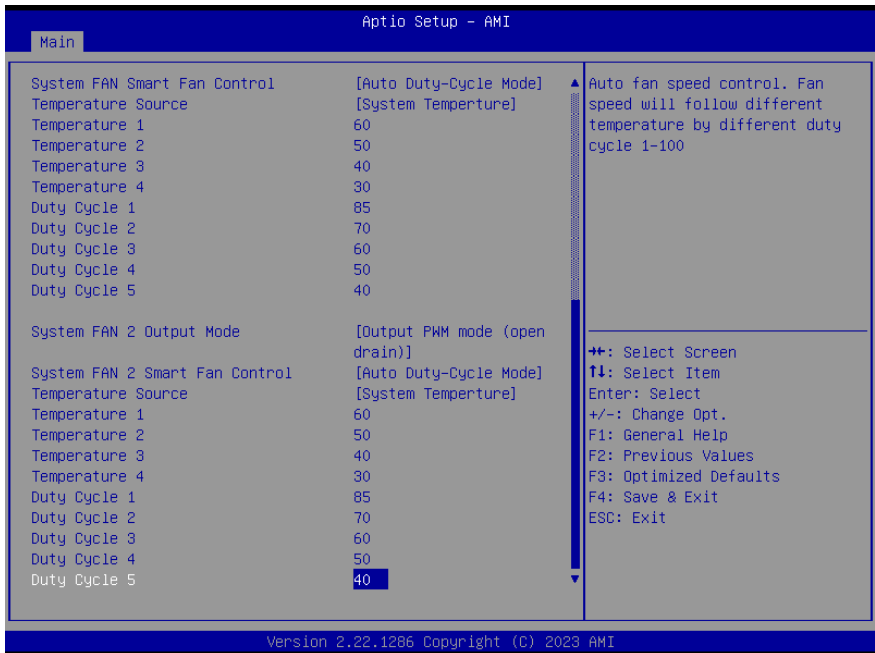

| Options Summary | | |
|--|------------------------------|-----------------------------------|
| System FAN 2 Output Mode | Output PWM mode (open drain) | Optimal Default, Failsafe Default |
| | Linear Fan Application | |
| | Output PWM mode (push pull) | |
| Output PWM mode (push pull) to control 4-wire fans. Linear fan application circuit to control 3-wire fan speed by fan's power terminal. Output PWM mode (open drain) to control Intel 4-wire fans. | | |
| System Fan 2 Smart Fan Control | Manual Duty Mode | |
| | Auto Duty-Cycle Mode | Optimal Default, Failsafe Default |
| Smart Fan Mode Select. | | |
| Temperature Source | CPU Temperature | |
| | System Temperature | |
| | System Temperature 2 | Optimal Default, Failsafe Default |
| Select the monitored temperature source for this fan. | | |
| Temperature 1 | 60 | Optimal Default, Failsafe Default |
| Temperature 2 | 50 | Optimal Default, Failsafe Default |
| Temperature 3 | 40 | Optimal Default, Failsafe Default |

| Options Summary | | |
|--|----|-----------------------------------|
| Temperature 4 | 30 | Optimal Default, Failsafe Default |
| Duty Cycle 1 | 85 | Optimal Default, Failsafe Default |
| Duty Cycle 2 | 70 | Optimal Default, Failsafe Default |
| Duty Cycle 3 | 60 | Optimal Default, Failsafe Default |
| Duty Cycle 4 | 50 | Optimal Default, Failsafe Default |
| Duty Cycle 5 | 40 | Optimal Default, Failsafe Default |
| Auto fan speed control. Fan speed will follow different temperature by different duty cycle 1-100. | | |

3.4.5 Power Management

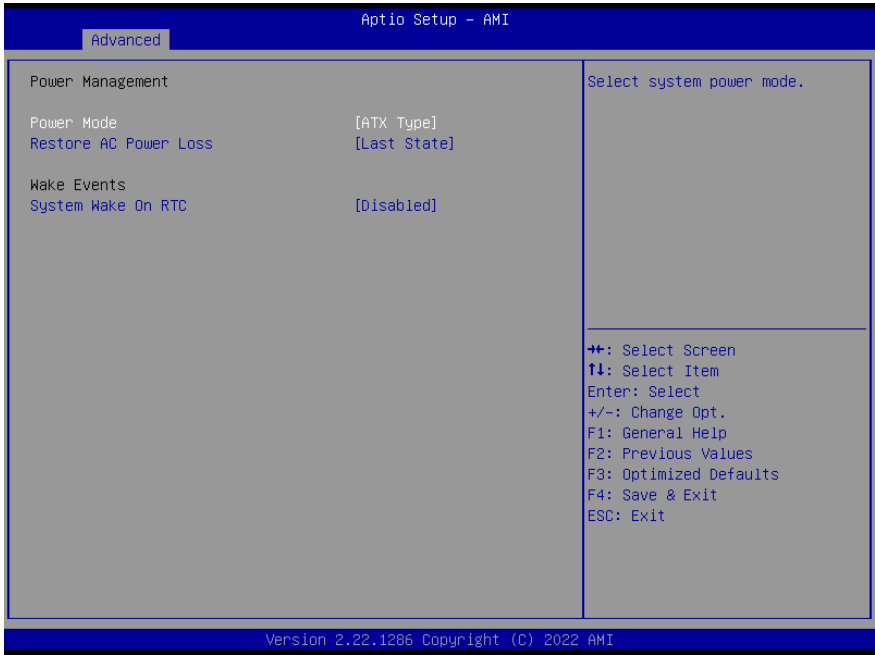

| Options Summary | | |
|---|------------|-----------------------------------|
| Power Mode | ATX Type | Optimal Default, Failsafe Default |
| | AT Type | |
| Select system power mode. | | |
| Restore AC Power Loss | Last State | Optimal Default, Failsafe Default |
| | Always On | |
| | Always Off | |
| Set GPI[3:0] Output as Hi or Low. | | |
| System Wake On RTC | Disabled | Optimal Default, Failsafe Default |
| | By Date | |
| | By Weekday | |
| | Bypass | |
| By Date: System will wake on the day with hr::min::sec specified. By Weekday: System will wake on the enabled weekday with hr::min::sec specified. Bypass: BIOS will not control RTC wake function. | | |

3.4.6 AAEON BIOS Robot

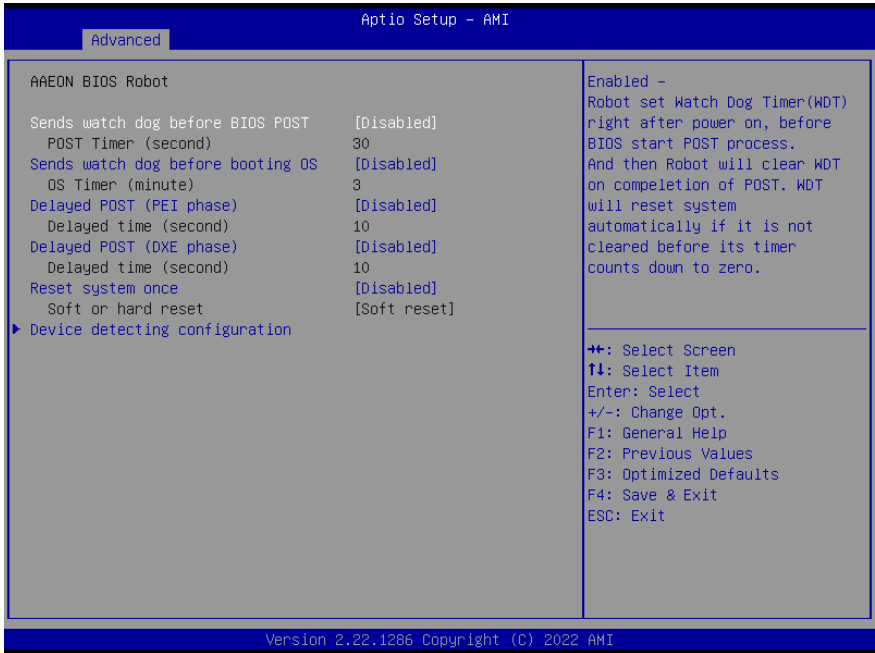

| Options Summary | | |
|--|----------|-----------------------------------|
| Sends watch dog before BIOS POST | Disabled | Optimal Default, Failsafe Default |
| | Enabled | |
| <p>Enabled – Robot set Watch Dog Timer (WDT) right after power on, before BIOS start POST process. And then Robot will clear WDT on completion of POST. WDT on completion of POST. WDT. WDT will reset system automatically if it is not cleared before its timer counts down to zero.</p> | | |
| Sends watch dog before booting OS | Disabled | Optimal Default, Failsafe Default |
| | Enabled | |
| <p>Enabled – Robot set Watch Dog Timer (WDT) after POST completion, before BIOS transfer control to OS. WARNING: Before enabling this function, a program in OS must be in responsible for clearing WDT. Also, this function should be disabled if OS I going to update itself.</p> | | |

| Options Summary | | |
|--|----------|-----------------------------------|
| Delayed POST (PEI phase) | Disabled | Optimal Default, Failsafe Default |
| | Enabled | |
| <p>Enabled -Robot holds BIOS from starting POST, right after power on. This allows BIOS POST to start with stable power or start after system is physically warmed-up.</p> <p>Note: Robot does this before 'Sends watch dog'.</p> | | |
| Delayed POST (DXE phase) | Disabled | Optimal Default, Failsafe Default |
| | Enabled | |
| <p>Enabled -Robot holds BIOS before POST completion. This allows BIOS POST to start with stable power or start after system is physically warmed-up.</p> <p>Note: Robot does this after 'Sends watch dog before BIOS POST'.</p> | | |

3.4.6.1 Device Detecting Configuration

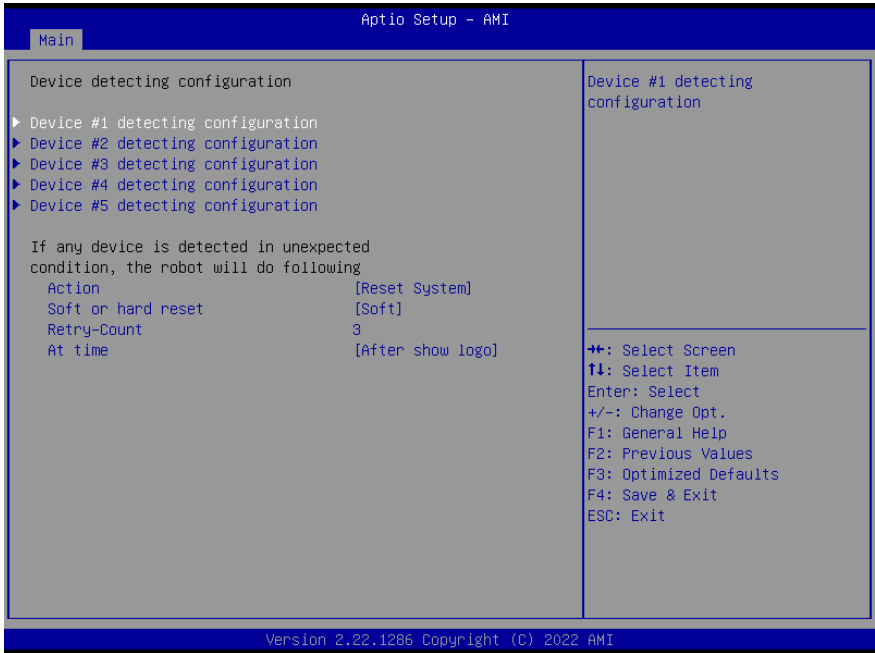

| Options Summary | | |
|--|------------------|-----------------------------------|
| Action | Reset System | Optimal Default, Failsafe Default |
| | Hold System | |
| Select action that robot should do. | | |
| Soft or hard reset | Soft | Optimal Default, Failsafe Default |
| | Hard | |
| Select reset type robot should send on each boot. | | |
| Retry-Count | 3 | Optimal Default, Failsafe Default |
| Fill retry counter here. Robot will reset system at most counter times, and then let system continue its POST. | | |
| At time | After shoe logo | Optimal Default, Failsafe Default |
| | Before show logo | |
| Select robot action time: After show logo - Robot will do action after logo is displayed. System devices are almost ready. | | |
| Before show logo - Robot will do action earlier before logo, but some devices may not be ready. | | |

3.4.6.1.1 Device #1 Detecting Configuration

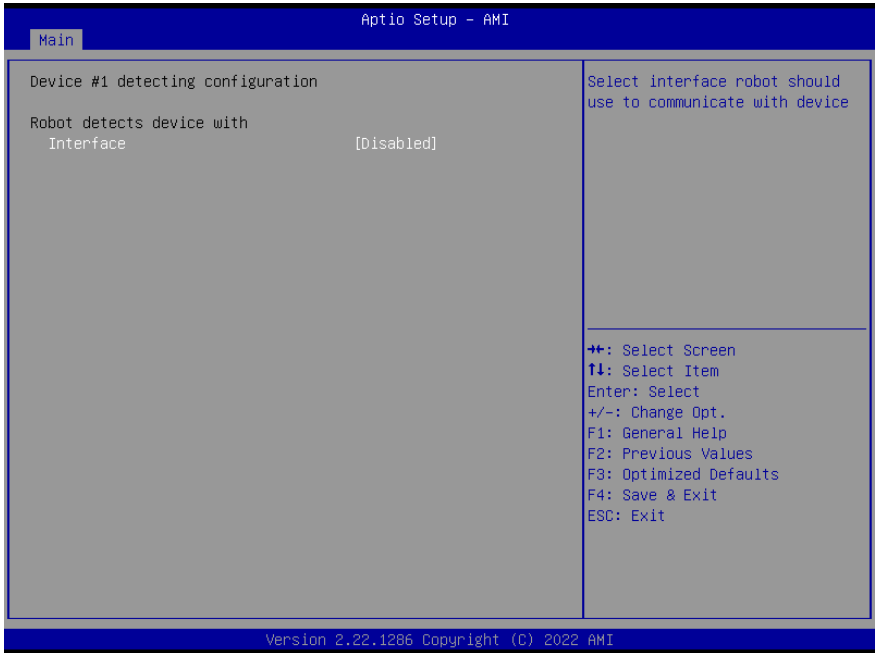

| Options Summary | | |
|---|------------|-----------------------------------|
| Interface | Disabled | Optimal Default, Failsafe Default |
| | PCI | |
| | DIO | |
| | SMBUS | |
| | Legacy I/O | |
| | Super I/O | |
| | MMIO | |
| Select interface robot should use to communicate with device. | | |

3.4.6.1.2 Device #2 Detecting Configuration

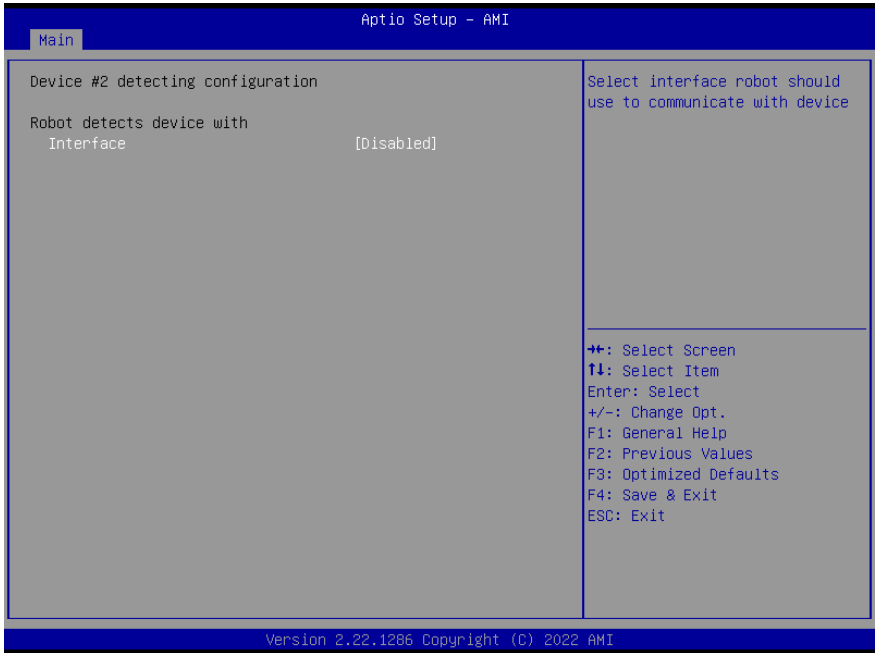

| Options Summary | | |
|---|------------|-----------------------------------|
| Interface | Disabled | Optimal Default, Failsafe Default |
| | PCI | |
| | DIO | |
| | SMBUS | |
| | Legacy I/O | |
| | Super I/O | |
| | MMIO | |
| Select interface robot should use to communicate with device. | | |

3.4.6.1.3 Device #3 Detecting Configuration

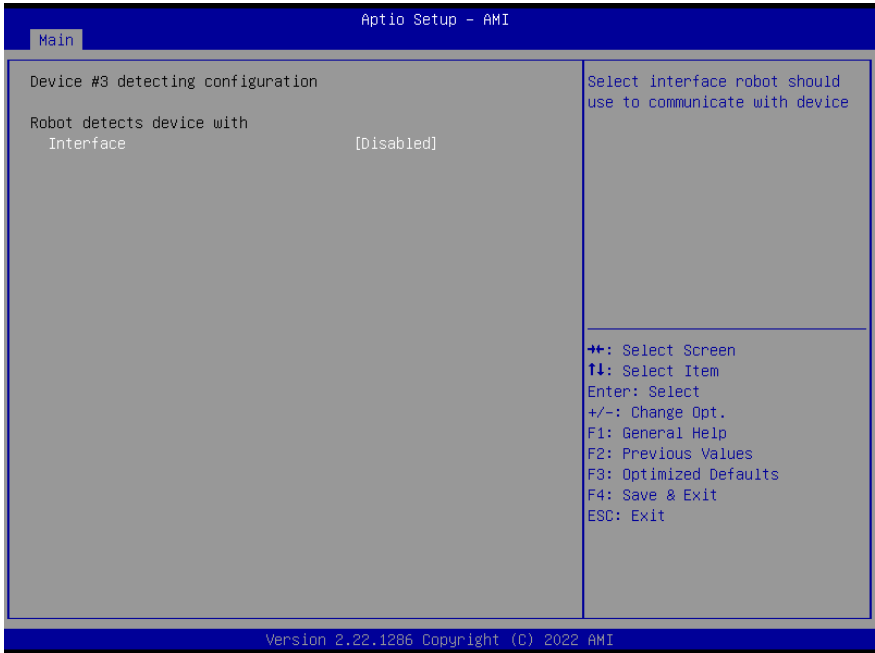

| Options Summary | | |
|---|------------|-----------------------------------|
| Interface | Disabled | Optimal Default, Failsafe Default |
| | PCI | |
| | DIO | |
| | SMBUS | |
| | Legacy I/O | |
| | Super I/O | |
| | MMIO | |
| Select interface robot should use to communicate with device. | | |

3.4.6.1.4 Device #4 Detecting Configuration

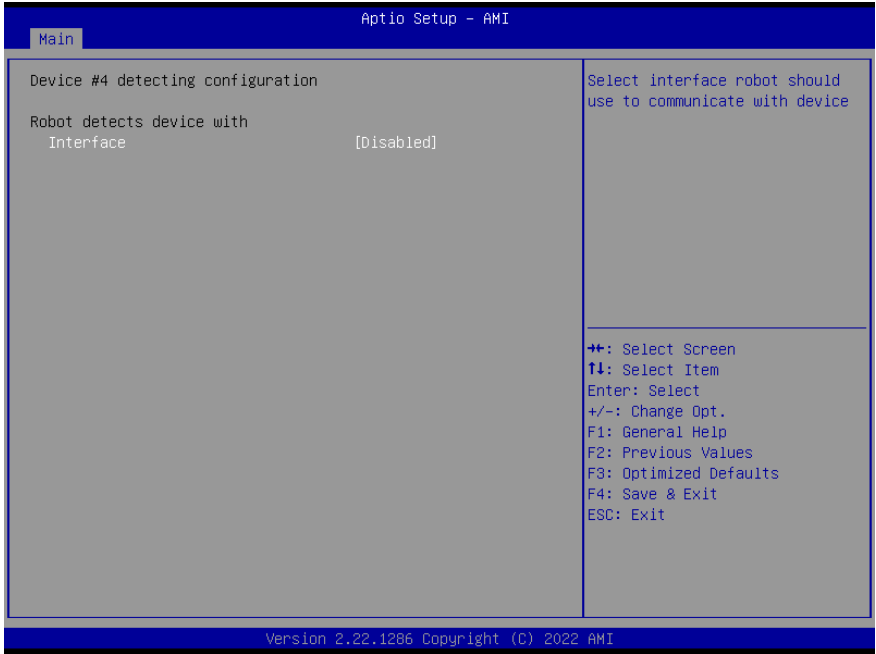

| Options Summary | | |
|---|------------|-----------------------------------|
| Interface | Disabled | Optimal Default, Failsafe Default |
| | PCI | |
| | DIO | |
| | SMBUS | |
| | Legacy I/O | |
| | Super I/O | |
| | MMIO | |
| Select interface robot should use to communicate with device. | | |

3.4.6.1.5 Device #5 Detecting Configuration

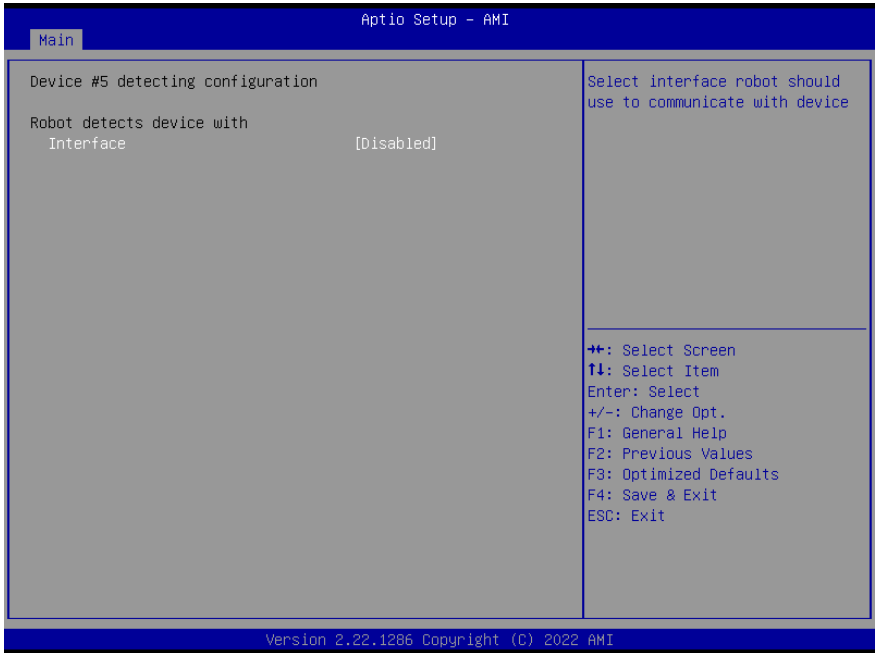

| Options Summary | | |
|---|------------|-----------------------------------|
| Interface | Disabled | Optimal Default, Failsafe Default |
| | PCI | |
| | DIO | |
| | SMBUS | |
| | Legacy I/O | |
| | Super I/O | |
| | MMIO | |
| Select interface robot should use to communicate with device. | | |

3.5 Setup Submenu: System I/O



3.5.1 PCI Express Configuration

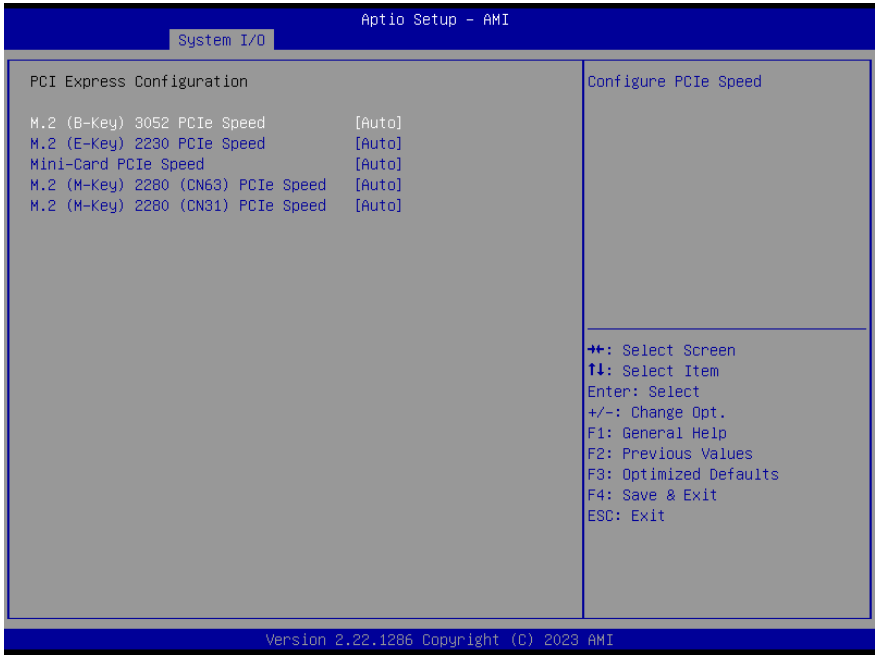

| Options Summary | | |
|------------------------------------|------|-----------------------------------|
| M.2 (B-Key) 3052 PCIe Speed | Auto | Optimal Default, Failsafe Default |
| | Gen1 | |
| | Gen2 | |
| | Gen3 | |
| | Gen4 | |
| Configure PCIe Speed. | | |
| M.2 (E-Key) 2230 PCIe Speed | Auto | Optimal Default, Failsafe Default |
| | Gen1 | |
| | Gen2 | |
| | Gen3 | |
| | Gen4 | |
| Configure PCIe Speed. | | |
| Mini-Card PCIe Speed | Auto | Optimal Default, Failsafe Default |
| | Gen1 | |
| | Gen2 | |

| Options Summary | | |
|---------------------------------------|------|-----------------------------------|
| Configure PCIe Speed | | |
| M.2 (M-Key) 2280 (CN63) PCIe Speed | Auto | Optimal Default, Failsafe Default |
| | Gen1 | |
| | Gen2 | |
| | Gen3 | |
| | Gen4 | |
| Configure PCIe Speed. | | |
| M.2 (M-Key) 2280 (CN31) PCIe Speed | Auto | Optimal Default, Failsafe Default |
| | Gen1 | |
| | Gen2 | |
| | Gen3 | |
| | Gen4 | |
| Configure PCIe Speed. | | |

3.5.2 Storage Configuration

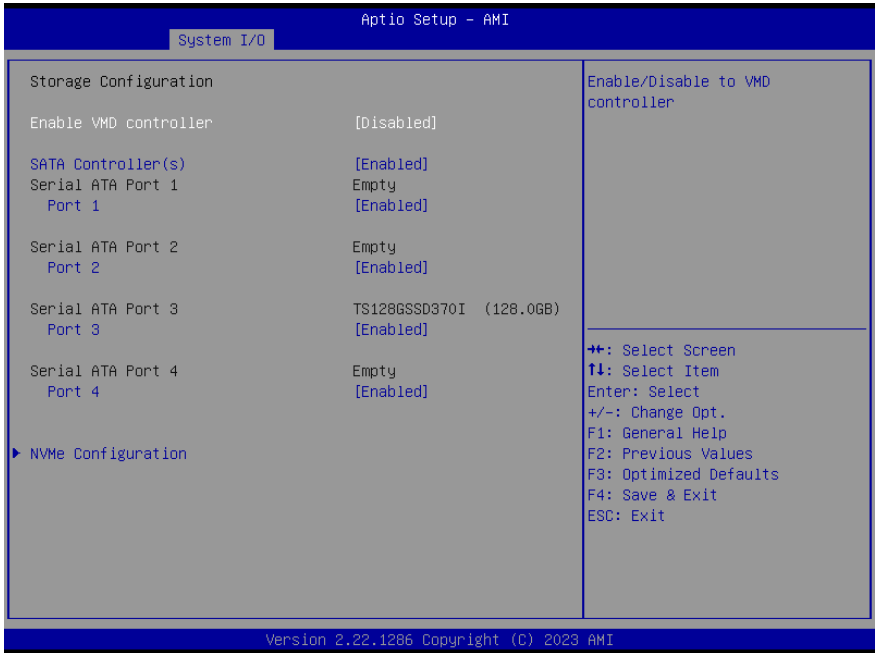

| Options Summary | | |
|-----------------------------------|----------|-----------------------------------|
| Enable VMD controller | Disabled | Optimal Default, Failsafe Default |
| | Enabled | |
| Enable/Disable to VMD controller. | | |
| SATA Controller(s) | Enabled | Optimal Default, Failsafe Default |
| | Disabled | |
| Enable/Disable to SATA Device. | | |
| Port 1 | Enabled | Optimal Default, Failsafe Default |
| | Disabled | |
| Enable or Disable SATA Port. | | |
| Port 2 | Enabled | Optimal Default, Failsafe Default |
| | Disabled | |
| Enable or Disable SATA Port. | | |
| Port 3 | Enabled | Optimal Default, Failsafe Default |
| | Disabled | |
| Enable or Disable SATA Port. | | |

| Options Summary | | |
|------------------------------|----------|-----------------------------------|
| Port 4 | Enabled | Optimal Default, Failsafe Default |
| | Disabled | |
| Enable or Disable SATA Port. | | |

3.5.2.1 NVMe Configuration

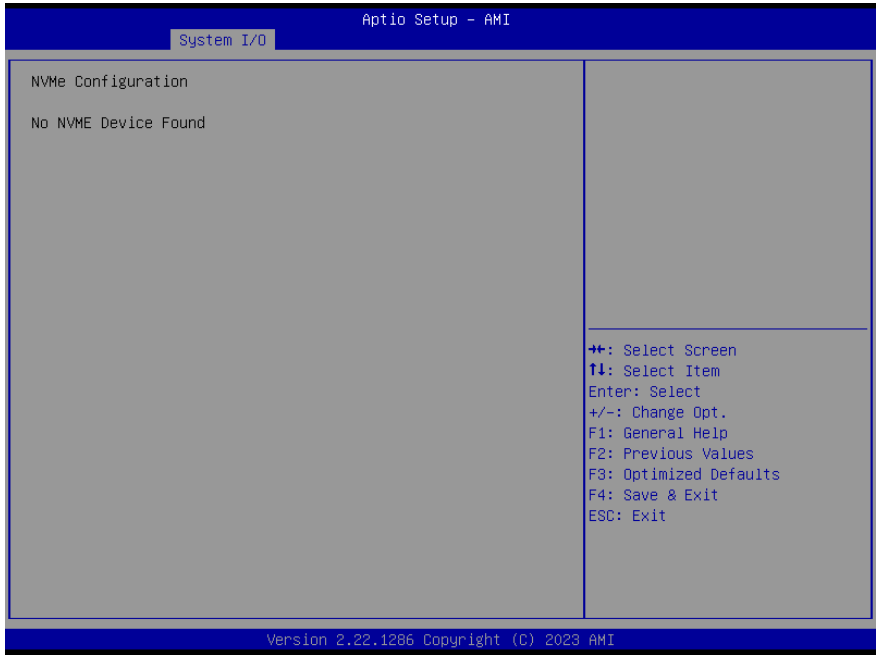

3.5.3 HD Audio Configuration



Options Summary

| | | |
|-----------------|----------|-----------------------------------|
| HD Audio | Disabled | |
| | Enabled | Optimal Default, Failsafe Default |

Control Detection of the HD-Audio device.
 Disabled = HDA will be unconditionally disabled.
 Enabled = HDA will be unconditionally enabled.

3.5.4 Digital IO Port Configuration

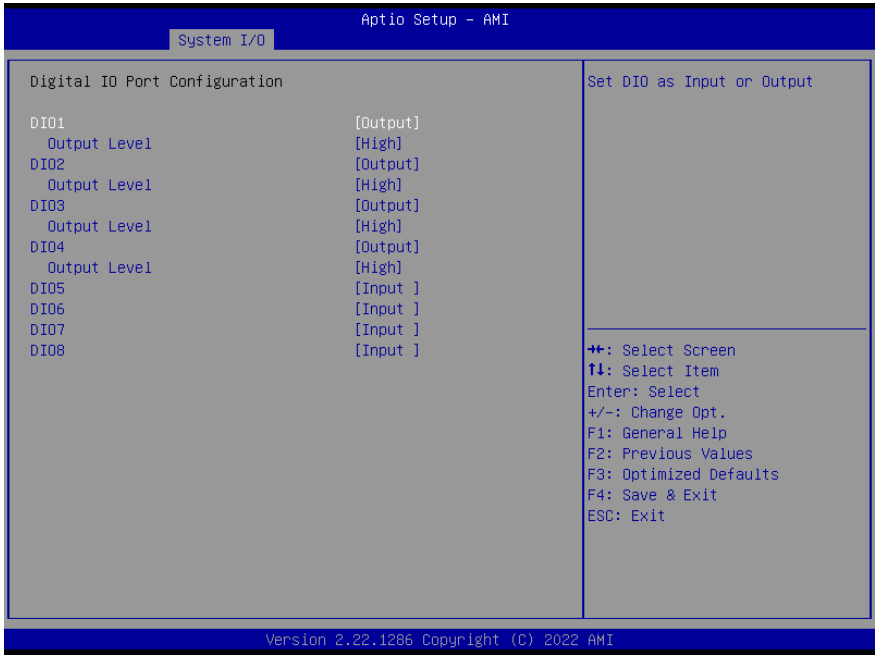

| Options Summary | | |
|--|--------|-----------------------------------|
| DIO1 | Input | |
| | Output | Optimal Default, Failsafe Default |
| Set DIO as Input or Output. | | |
| Output Level | Low | |
| | High | Optimal Default, Failsafe Default |
| Set output level when DIO pin is output. | | |
| DIO2 | Input | |
| | Output | Optimal Default, Failsafe Default |
| Set DIO as Input or Output. | | |
| Output Level | Low | |
| | High | Optimal Default, Failsafe Default |
| Set output level when DIO pin is output. | | |
| DIO3 | Input | |
| | Output | Optimal Default, Failsafe Default |
| Set DIO as Input or Output. | | |

| Options Summary | | |
|--|--------|-----------------------------------|
| Output Level | Low | |
| | High | Optimal Default, Failsafe Default |
| Set output level when DIO pin is output. | | |
| DIO4 | Input | |
| | Output | Optimal Default, Failsafe Default |
| Set DIO as Input or Output. | | |
| Output Level | Low | |
| | High | Optimal Default, Failsafe Default |
| Set output level when DIO pin is output. | | |
| DIO5 | Input | Optimal Default, Failsafe Default |
| | Output | |
| Set DIO as Input or Output. | | |
| DIO6 | Input | Optimal Default, Failsafe Default |
| | Output | |
| Set DIO as Input or Output. | | |
| DIO7 | Input | Optimal Default, Failsafe Default |
| | Output | |
| Set DIO as Input or Output. | | |
| DIO8 | Input | Optimal Default, Failsafe Default |
| | Output | |
| Set DIO as Input or Output. | | |

3.5.5 Legacy Logical Devices Configuration

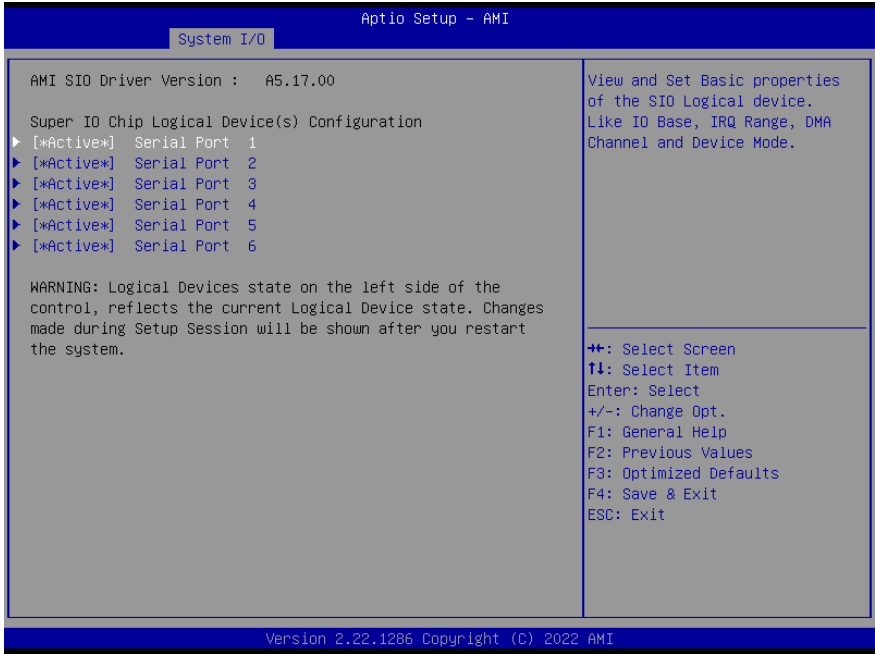

3.5.5.1 Serial Port 1

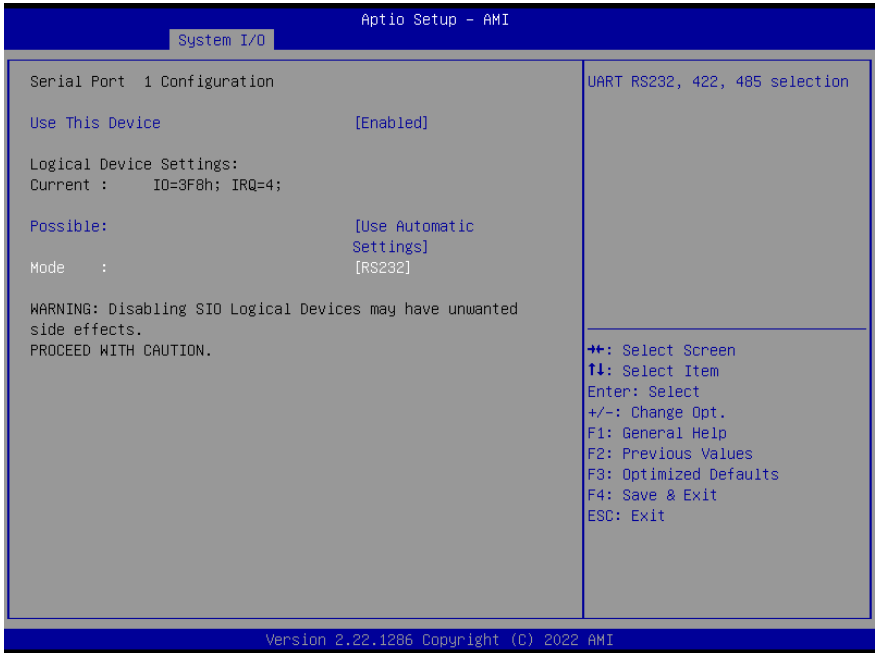

| Options Summary | | |
|--|------------------------|-----------------------------------|
| Use This Device | Disabled | |
| | Enabled | Optimal Default, Failsafe Default |
| Enable or Disable this Logical Device. | | |
| Possible: | Use Automatic Settings | Optimal Default, Failsafe Default |
| | IO=3F8; IRQ=4; | |
| | IO=2F8; IRQ=3; | |
| Allows the user to change the device resource settings. New settings will be reflected on this setup page after system restarts. | | |
| Mode | RS232 | Optimal Default, Failsafe Default |
| | RS422 | |
| | RS485 | |
| UART RS232, 422, 485, selection. | | |

3.5.5.2 Serial Port 2

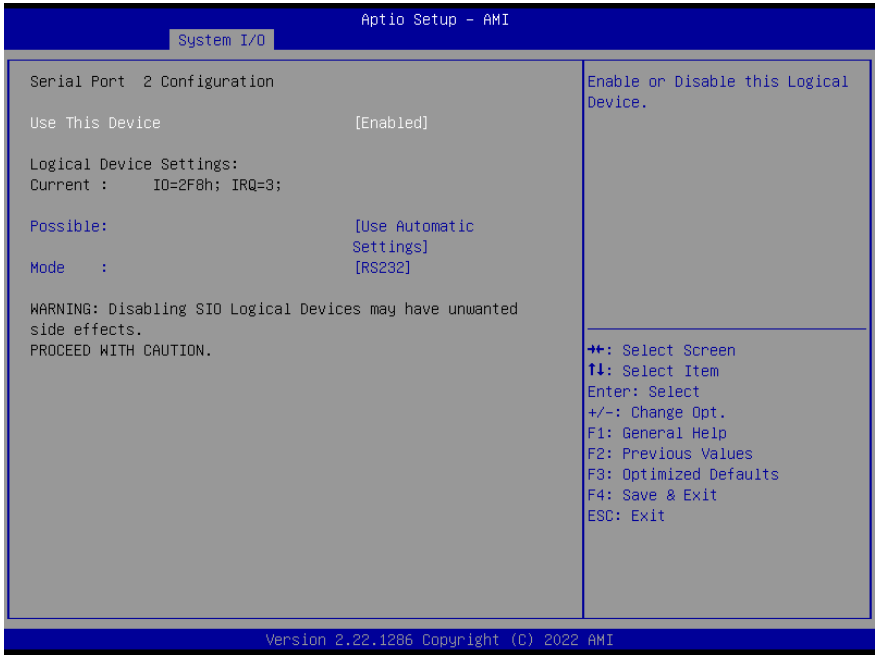

| Options Summary | | |
|--|------------------------|-----------------------------------|
| Use This Device | Disabled | |
| | Enabled | Optimal Default, Failsafe Default |
| Enable or Disable this Logical Device. | | |
| Possible: | Use Automatic Settings | Optimal Default, Failsafe Default |
| | IO=2F8; IRQ=3; | |
| | IO=3F8; IRQ=4; | |
| Allows the user to change the device resource settings. New settings will be reflected on this setup page after system restarts. | | |
| Mode | RS232 | Optimal Default, Failsafe Default |
| | RS422 | |
| | RS485 | |
| UART RS232, 422, 485, selection. | | |

3.5.5.3 Serial Port 3

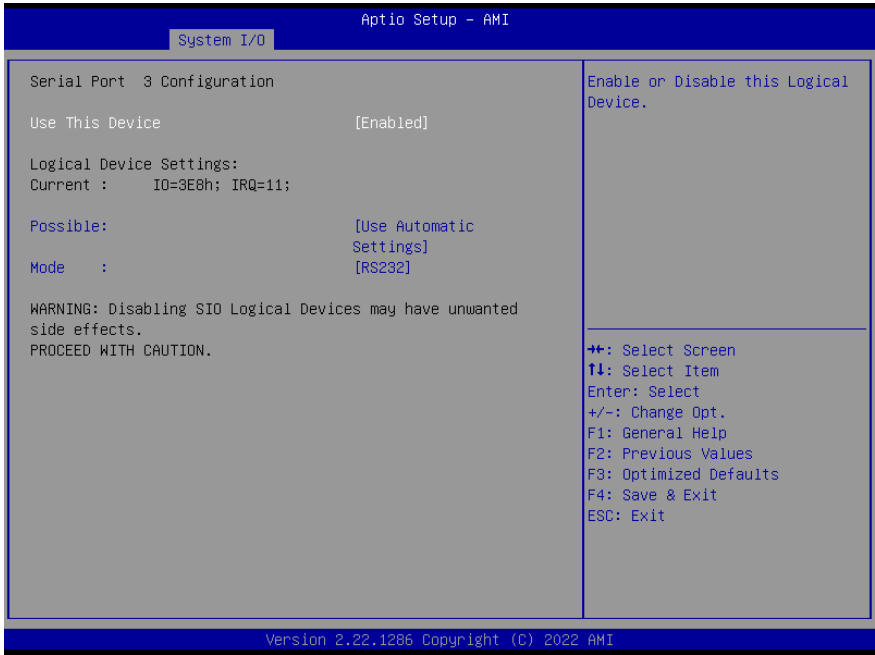

| Options Summary | | |
|--|------------------------|-----------------------------------|
| Use This Device | Disabled | |
| | Enabled | Optimal Default, Failsafe Default |
| Enable or Disable this Logical Device. | | |
| Possible: | Use Automatic Settings | Optimal Default, Failsafe Default |
| | IO=3E8; IRQ=11; | |
| | IO=2E8; IRQ=11; | |
| Allows the user to change the device resource settings. New settings will be reflected on this setup page after system restarts. | | |
| Mode | RS232 | Optimal Default, Failsafe Default |
| | RS422 | |
| | RS485 | |
| UART RS232, 422, 485, selection. | | |

3.5.5.4 Serial Port 4



| Options Summary | | |
|--|------------------------|-----------------------------------|
| Use This Device | Disabled | |
| | Enabled | Optimal Default, Failsafe Default |
| Enable or Disable this Logical Device. | | |
| Possible: | Use Automatic Settings | Optimal Default, Failsafe Default |
| | IO=2E8; IRQ=11; | |
| | IO=3E8; IRQ=11; | |
| Allows the user to change the device resource settings. New settings will be reflected on this setup page after system restarts. | | |
| Mode | RS232 | Optimal Default, Failsafe Default |
| | RS422 | |
| | RS485 | |
| UART RS232, 422, 485, selection. | | |

3.5.5.5 Serial Port 5

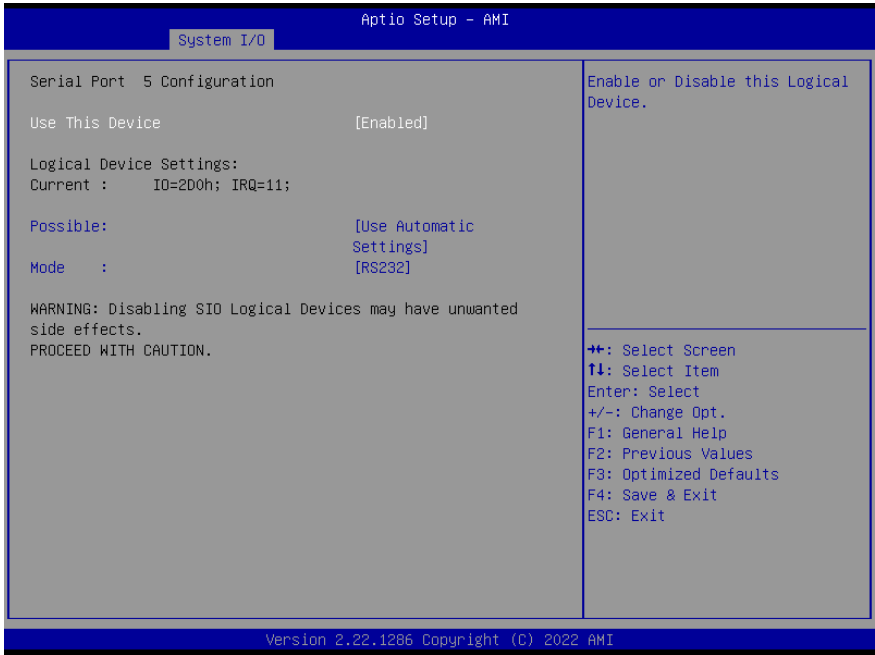

| Options Summary | | |
|--|------------------------|-----------------------------------|
| Use This Device | Disabled | |
| | Enabled | Optimal Default, Failsafe Default |
| Enable or Disable this Logical Device. | | |
| Possible: | Use Automatic Settings | Optimal Default, Failsafe Default |
| | IO=2D0; IRQ=11; | |
| | IO=2C0; IRQ=11; | |
| Allows the user to change the device resource settings. New settings will be reflected on this setup page after system restarts. | | |
| Mode | RS232 | Optimal Default, Failsafe Default |
| | RS422 | |
| | RS485 | |
| UART RS232, 422, 485, selection. | | |

3.5.5.6 Serial Port 6

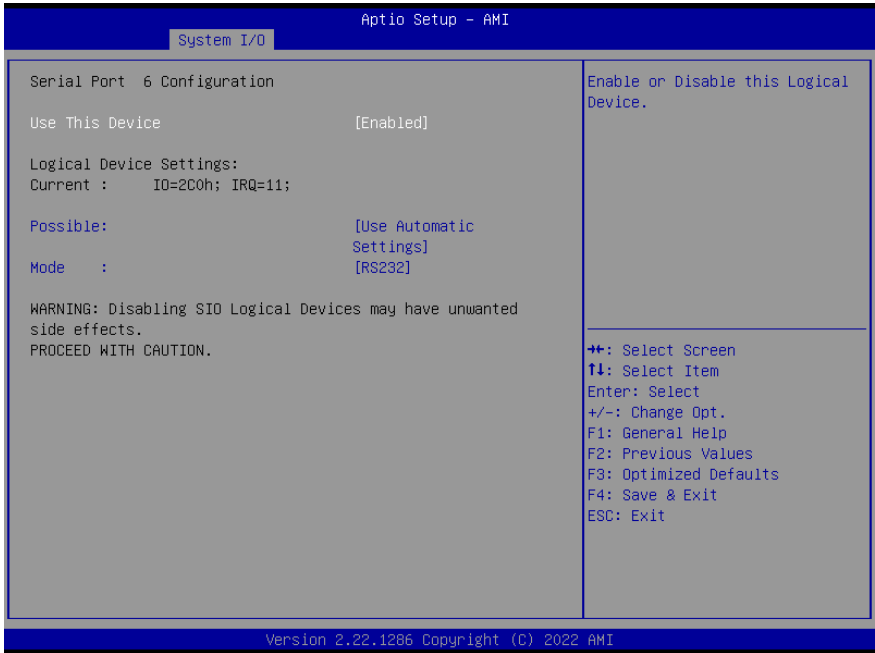

| Options Summary | | |
|--|------------------------|-----------------------------------|
| Use This Device | Disabled | |
| | Enabled | Optimal Default, Failsafe Default |
| Enable or Disable this Logical Device. | | |
| Possible: | Use Automatic Settings | Optimal Default, Failsafe Default |
| | IO=2C0; IRQ=11; | |
| | IO=2D0; IRQ=11; | |
| Allows the user to change the device resource settings. New settings will be reflected on this setup page after system restarts. | | |
| Mode | RS232 | Optimal Default, Failsafe Default |
| | RS422 | |
| | RS485 | |
| UART RS232, 422, 485, selection. | | |

3.5.6 Serial Port Console Redirection

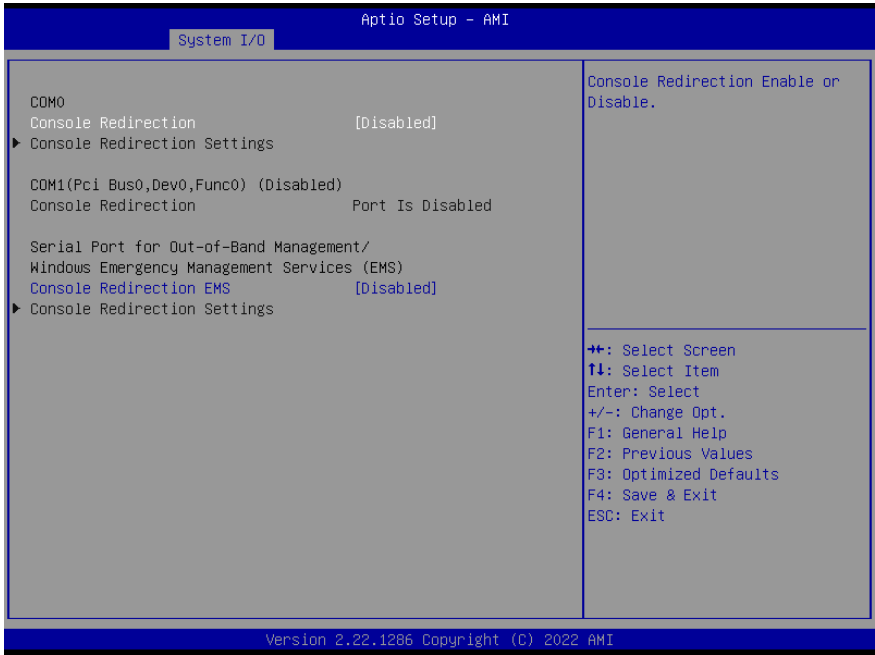

| Options Summary | | |
|--|----------|-----------------------------------|
| Console Redirection | Disabled | Optimal Default, Failsafe Default |
| | Enabled | |
| Console Redirection Enable or Disable. | | |
| Console Redirection EMS | Disabled | Optimal Default, Failsafe Default |
| | Enabled | |
| Console Redirection Enable or Disable. | | |

3.5.6.1 Console Redirection Settings (COM0)

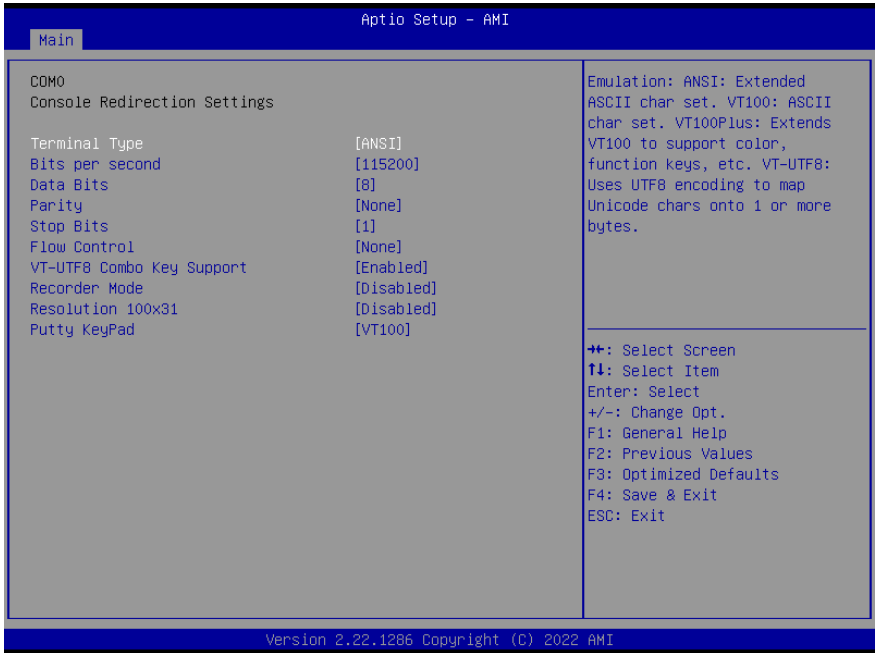

| Options Summary | | |
|---|-----------|-----------------------------------|
| Terminal Type | VT100 | |
| | VT100Plus | |
| | VT-UTF8 | |
| | ANSI | Optimal Default, Failsafe Default |
| Emulation: ANSI: Extended ASCII char set. VT100: ASCII char set. VT100Plus: Extends VT100 to support color, function keys, etc. VT-UTF8: Uses UTF8 encoding to map Unicode chars onto 1 or more bytes. | | |
| Bits per second | 9600 | |
| | 19200 | |
| | 38400 | |
| | 57600 | |
| | 115200 | Optimal Default, Failsafe Default |

| Options Summary | | |
|---|------------------|-----------------------------------|
| Selects serial port transmission speed. The speed must be matched on the other side. Long or noisy lines may require lower speeds. | | |
| Data Bits | 7 | |
| | 8 | Optimal Default, Failsafe Default |
| Data Bits. | | |
| Parity | None | Optimal Default, Failsafe Default |
| | Even | |
| | Odd | |
| | Mark | |
| | Space | |
| A parity bit can be sent with the data bits to detect some transmission errors. Even: parity bit is 0 if the num of 1's in the data bits is even. Odd: parity bit is 0 if num of 1's in the data bits is odd. Mark: parity bit is always 1. Space: Parity bit is always 0. Mark and Space Parity do not allow for error detection. They can be used as an additional data bit. | | |
| Stop Bits | 1 | Optimal Default, Failsafe Default |
| | 2 | |
| Stop bits indicate the end of a serial data packet. (A start bit indicates the beginning). The standard setting is 1 stop bit. Communication with slow devices may require more than 1 stop bit. | | |
| Flow Control | None | Optimal Default, Failsafe Default |
| | Hardware RTS/CTS | |
| Flow control can prevent data loss from buffer overflow. When sending data, if the receiving buffers are full, a 'stop' signal can be sent to stop the data flow. Once the buffers are empty, a 'start' signal can be sent to re-start the flow. Hardware flow control uses two wires to send start/stop signals. | | |
| VT-UTF8 Combo Key Support | Disabled | |
| | Enabled | Optimal Default, Failsafe Default |
| Enable VT-UTF8 Combination Key Support for ANSI/VT100 terminals. | | |
| Recorder Mode | Disabled | Optimal Default, Failsafe Default |
| | Enabled | |
| With this mode enabled only text will be sent. This is to capture Terminal data. | | |
| Resolution 100x31 | Disabled | Optimal Default, Failsafe Default |
| | Enabled | |
| Enables or disables extended terminal resolution. | | |

| Options Summary | | |
|---|---------|-----------------------------------|
| Putty KeyPad | VT100 | Optimal Default, Failsafe Default |
| | LINUX | |
| | XTERMR6 | |
| | SCO | |
| | ESCN | |
| | VT400 | |
| Select FunctionKey and KeyPad on Putty. | | |

3.5.6.2 Console Redirection Settings (Out-of-Band Mgmt)

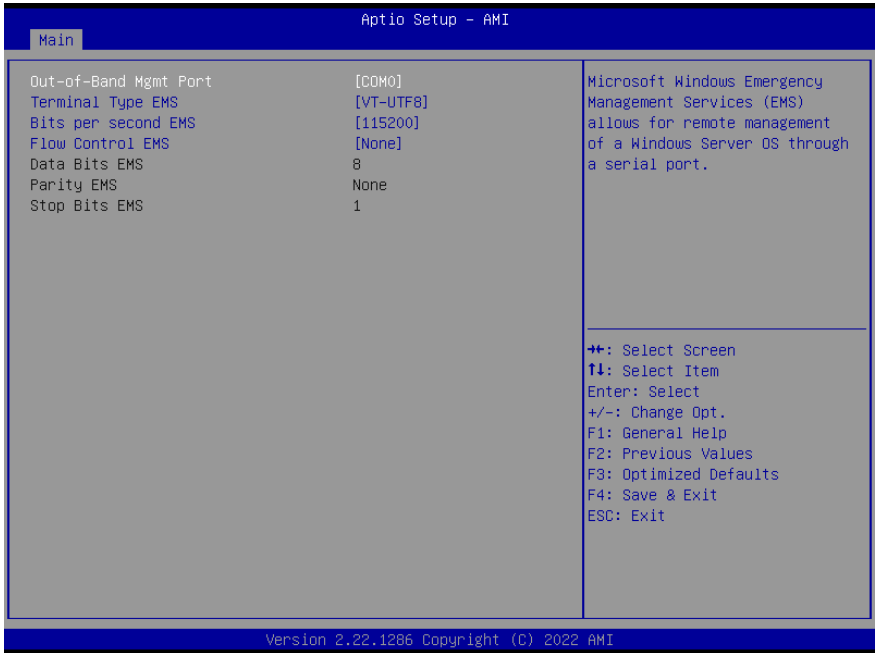

| Options Summary | | |
|--|--|-----------------------------------|
| Out-of-Band Mgmt Port | COM0 | Optimal Default, Failsafe Default |
| | COM1(Pci Bus0, Dev0, Func0) (Disabled) | |
| Microsoft Windows Emergency Management Services (EMS) allows for remote management of a Windows Server OS through a serial port. | | |
| Terminal Type EMS | VT100 | |
| | VT100Plus | |
| | VT-UTF8 | Optimal Default, Failsafe Default |
| | ANSI | |
| VT-UTF8 is the preferred terminal type for out-of-band management. The next best choice is VT100+ and then VT100. See above, in Console Redirection Settings page, for more Help with Terminal Type/Emulation. | | |
| Bits per second EMS | 9600 | |
| | 19200 | |
| | 57600 | |

| Options Summary | | |
|---|-------------------|-----------------------------------|
| Bits per second EMS | 115200 | Optimal Default, Failsafe Default |
| Selects serial port transmission speed. The speed must be matched on the other side. Long or noisy lines may require lower speeds. | | |
| Flow Control EMS | None | Optimal Default, Failsafe Default |
| | Hardware RTS/CTS | |
| | Software Xon/Xoff | |
| Flow control can prevent data loss from buffer overflow. When sending data, if the receiving buffers are full, a 'stop' signal can be sent to stop the data flow. Once the buffers are empty, a 'start' signal can be sent to re-start the flow. Hardware flow control uses two wires to send start/stop signals. | | |

3.6 Setup Submenu: Security

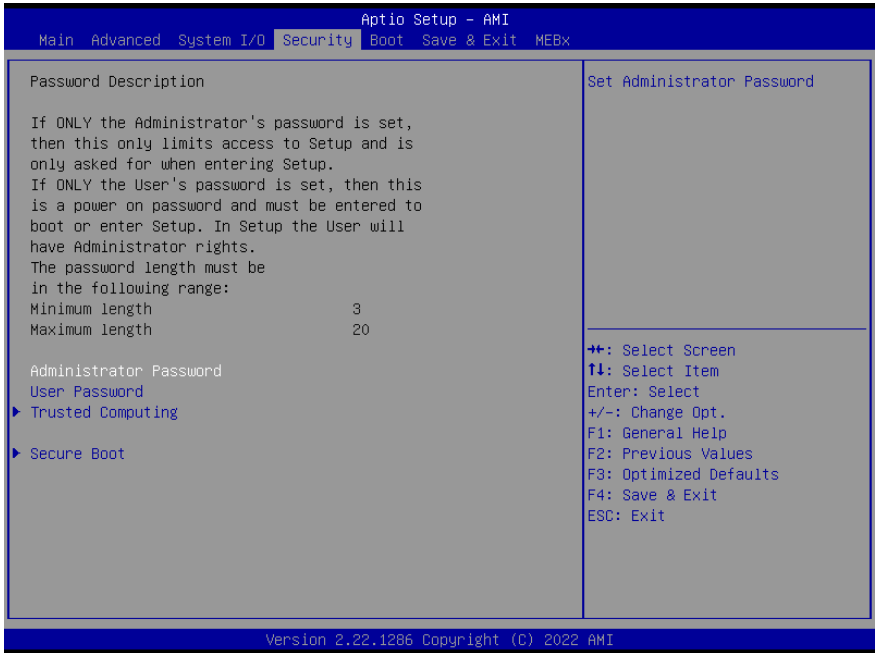

Change User/Administrator Password

You can set a User Password once an Administrator Password. The password will be required during boot up, or when the user enters the Setup utility. Please Note that a User Password does not provide access to many of the features in the Setup utility. Select the password you wish to set, press Enter to open a dialog box to enter your password (you can enter no more than six letters or numbers). Press Enter to confirm your entry, after which you will be prompted to retype your password for a final confirmation. Press Enter again after you have retyped it correctly.

Removing the Password

Highlight this item and type in the current password. At the next dialog box press Enter to disable password protection.

3.6.1 Trusted Computing

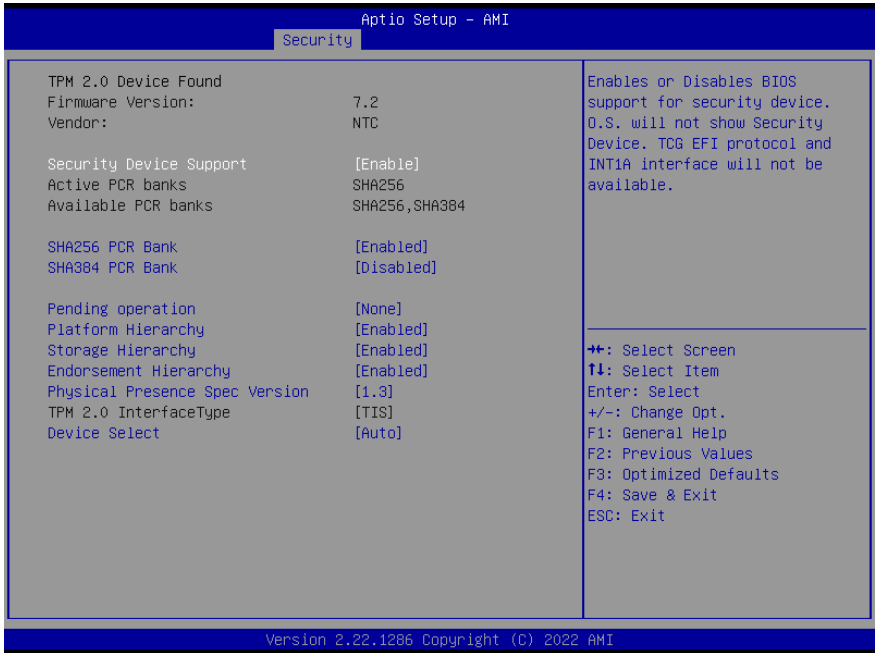

| Options Summary | | |
|---|-----------|-----------------------------------|
| Security Device Support | Enable | Optimal Default, Failsafe Default |
| | Disable | |
| Enables or Disables BIOS support for security device. O.S. will not show Security Device. TCG EFI protocol and INT1A interface will not be available. | | |
| SHA256 PCR Bank | Disabled | |
| | Enabled | Optimal Default, Failsafe Default |
| Enable or Disable SHA256 PCR Bank. | | |
| SHA384 PCR Bank | Disabled | Optimal Default, Failsafe Default |
| | Enabled | |
| Enable or Disable SHA384 PCR Bank. | | |
| Pending operation | None | Optimal Default, Failsafe Default |
| | TPM Clear | |
| Schedule an Operation for the Security Device. NOTE: Your Computer will reboot during restart in order to change State of Security Device. | | |

| Options Summary | | |
|---|----------|-----------------------------------|
| Platform Hierarchy | Disabled | |
| | Enabled | Optimal Default, Failsafe Default |
| Enable or Disable Platform Hierarchy. | | |
| Storage Hierarchy | Disabled | |
| | Enabled | Optimal Default, Failsafe Default |
| Enable or Disable Storage Hierarchy. | | |
| Endorsement Hierarchy | Disabled | |
| | Enabled | Optimal Default, Failsafe Default |
| Enable or Disable Endorsement Hierarchy. | | |
| Physical Presence Spec Version | 1.2 | |
| | 1.3 | Optimal Default, Failsafe Default |
| Select to Tell O.S. to support PPI Spec Version 1.2 or 1.3. Note some HCK tests might not support 1.3. | | |
| Device Select | TPM 1.2 | |
| | TPM 2.0 | |
| | Auto | Optimal Default, Failsafe Default |
| TPM 1.2 will restrict support to TPM 1.2 devices. TPM 2.0 will restrict support to TPM 2.0 devices. Auto will support both with the default set to TPM 2.0 devices if not found. TPM 1.2 devices will be enumerated. | | |

3.6.2 Secure Boot



| Options Summary | | |
|--|----------|-----------------------------------|
| Secure Boot | Disabled | Optimal Default, Failsafe Default |
| | Enabled | |
| Secure Boot feature is Active if Secure Boot is Enabled, Platform Key (PK) is enrolled and the System is in User mode. The mode change requires platform reset. | | |
| Secure Boot Mode | Standard | Optimal Default, Failsafe Default |
| | Custom | |
| Secure Boot mode options: Standard or Custom. In Custom mode, Secure Boot Policy variables can be configured by a physically present user without full authentication. | | |
| Restore Factory Keys | Yes | |
| | No | |
| Force System to User Mode. Install factory default Secure Boot key databases. | | |

3.6.2.1 Key Management

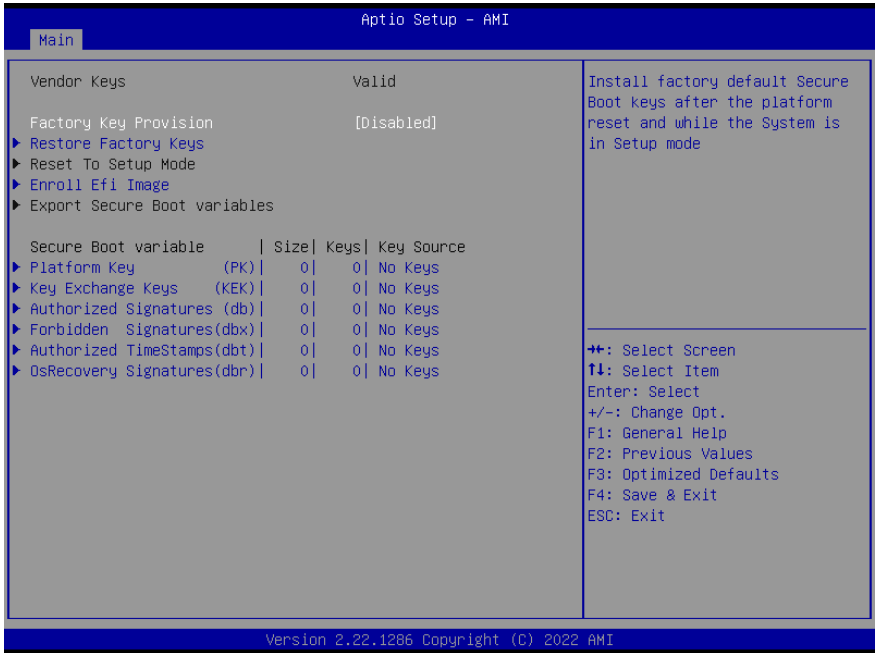

| Options Summary | | |
|---|----------|-----------------------------------|
| Factory Key Provision | Disabled | Optimal Default, Failsafe Default |
| | Enabled | |
| Install factory default Secure Boot keys after the platform reset and while the System is in Setup mode. | | |
| Restore Factory Keys | Yes | |
| | No | |
| Force System to User Mode. Install factory default Secure Boot key databases. | | |
| Enroll Efi Image | | |
| Allow Efi image to run in Secure Boot mode. Enroll SHA256 Hash certificate of a PE image into Authorized Signature Database (db). | | |
| Platform Key (PK) | Update | |
| Key Exchange Keys (KEK) | Update | |
| | Append | |
| Authorized Signatures (db) | Update | |
| | Append | |

Options Summary

| | | |
|------------------------------------|--------|--|
| Forbidden Signatures (dbx) | Update | |
| | Append | |
| Authorized TimeStamps (dbt) | Update | |
| | Append | |
| OsRecovery Signatures (dbr) | Update | |
| | Append | |

Enroll Factory Defaults or load certificates from a file:

1. Public Key Certificate:
 - a) EFI_SIGNATURE_LIST
 - b) EFI_CERT_X509 (DER)
 - c) EFI_CERT_RSA2048 (bin)
 - d) EFI_CERT_SHAXXX
2. Authenticated UEFI Variable
3. EFI PE/COFF Image (SHA256)

Key Source: Factory, External, Mixed.

3.7 Setup Submenu: Boot

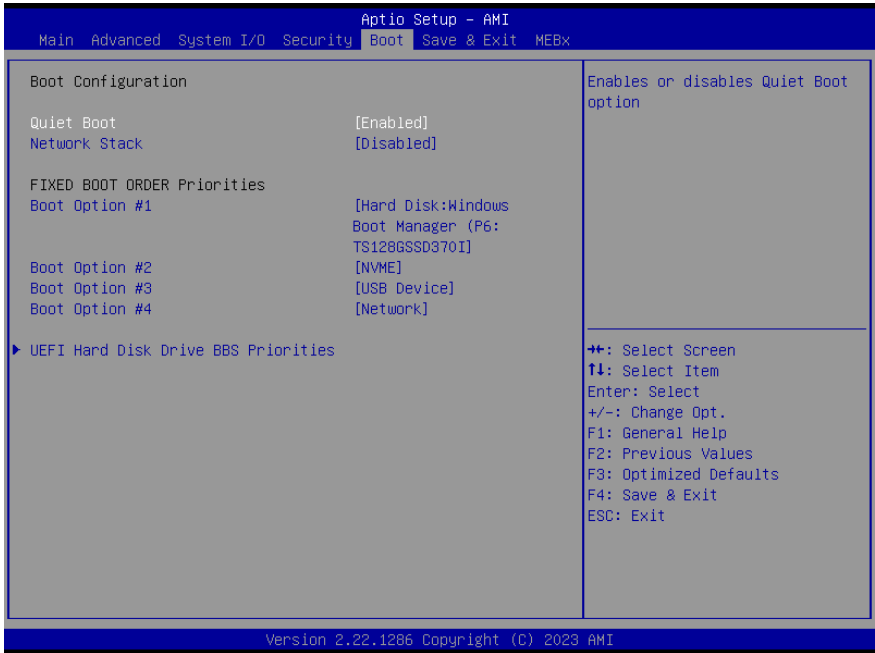

| Options Summary | | |
|-------------------------------------|------------|---------|
| Quiet Boot | Disabled | |
| | Enabled | Default |
| Enables/disables Quiet Boot option. | | |
| Network Stack | Disabled | Default |
| | Enabled | |
| Enable/Disable UEFI Network Stack. | | |
| Boot Option #1 | Hard Disk | |
| Boot Option #2 | NVME | |
| Boot Option #3 | USB Device | |
| Boot Option #4 | Network | |
| Sets the system boot order. | | |

3.7.1 UEFI Hard Disk Drive BBS Priorities



| Options Summary | | |
|-------------------------------------|------------|---------|
| Quiet Boot | Disabled | |
| | Enabled | Default |
| Enables/disables Quiet Boot option. | | |
| Network Stack | Disabled | Default |
| | Enabled | |
| Enable/Disable UEFI Network Stack. | | |
| Boot Option #1 | Hard Disk | |
| Boot Option #2 | NVME | |
| Boot Option #3 | USB Device | |
| Boot Option #4 | Network | |
| Sets the system boot order. | | |

3.8 Setup Submenu: Save & Exit

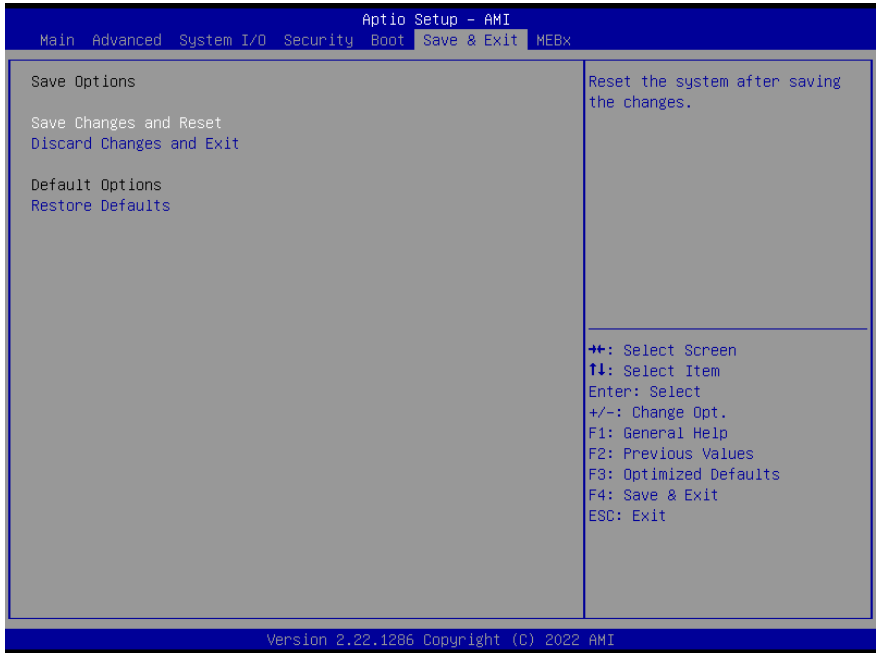

3.9 Setup Submenu: MEBx



Chapter 4

Drivers Installation

4.1 Drivers Download and Installation

Drivers for the BOXER-6843-ADS can be downloaded from the product page on the AAEON website by following this link:

<https://www.aaeon.com/en/>

Download the driver(s) you need and follow the steps below to install them.

Install Chipset Driver

1. Open the **Chipset** folder
2. Run the **SetupChipset.exe** file in the folder
3. Follow the instructions
4. Drivers will be installed automatically

Install Graphics Driver

1. Open the **Graphics** folder
2. Run the **Installer.exe** file in the folder
3. Follow the instructions
4. Drivers will be installed automatically

Install LAN Driver

1. Open the **LAN** folder
2. Run the **Autorun.exe** file in the folder
3. Follow the instructions
4. Drivers will be installed automatically

Install Audio Drivers

Note: Ensure Intel Smart Sound Driver (**Intel(R)_SST_ADL_v10.29.00.7919**) is installed before the Realtek Audio driver (**Realtek Audio 6.0.9239.1**)

a. Install Intel Smart Sound Driver

1. Open the **Audio (Intel(R)_SST_ADL_v10.29.00.7919)** folder
2. Follow the setup information within the file to manually install driver.

b. Install Realtek Audio Driver

1. Open the Realtek Audio Driver (ADSP-10.29.00.8467) folder
2. Run the **Setup.exe** file in the folder
3. Follow the instructions
4. Driver will be installed automatically

Install ME & TXE Drivers

1. Open the **ME & TXE** folder
2. Run the **SetupME.exe** file in the folder
3. Follow the instructions
4. Drivers will be installed automatically

Install Intel® RST Driver

1. Unzip the **RAID Driver** folder
2. Run the **SetupRST.exe** file in the folder
3. Follow the instructions
4. Drivers will be installed automatically

Install Serial Port Patch (Optional)

1. Open the **Serial Port Driver (Optional)** folder
2. Run the **FintekSerial.exe** file in the folder
3. Follow the instructions
4. Drivers will be installed automatically

Appendix A

I/O Information

A.1 I/O Address Map

The screenshot displays the Windows Device Manager window for a system named 'DESKTOP-KCVUBIL'. The 'Input/output (I/O)' category is expanded, showing a list of hardware devices with their corresponding I/O address ranges. The devices include various interrupt controllers, motherboard resources, system timers, Fintek Communications Ports (COM1 through COM6), Intel(R) PCI Express Root Ports, Intel(R) UHD Graphics 770, Standard SATA AHCI Controllers, and Intel(R) Active Management Technology - SOL (COM7).

| Address Range | Device Name |
|---|--|
| [0000000000000000 - 00000000000000CF7] | PCI Express Root Complex |
| [0000000000000020 - 0000000000000021] | Programmable interrupt controller |
| [0000000000000024 - 0000000000000025] | Programmable interrupt controller |
| [0000000000000028 - 0000000000000029] | Programmable interrupt controller |
| [000000000000002C - 000000000000002D] | Programmable interrupt controller |
| [000000000000002E - 000000000000002F] | Motherboard resources |
| [0000000000000030 - 0000000000000031] | Programmable interrupt controller |
| [0000000000000034 - 0000000000000035] | Programmable interrupt controller |
| [0000000000000038 - 0000000000000039] | Programmable interrupt controller |
| [000000000000003C - 000000000000003D] | Programmable interrupt controller |
| [0000000000000040 - 0000000000000043] | System timer |
| [000000000000004E - 000000000000004F] | Motherboard resources |
| [0000000000000050 - 0000000000000053] | System timer |
| [0000000000000061 - 0000000000000061] | Motherboard resources |
| [0000000000000063 - 0000000000000063] | Motherboard resources |
| [0000000000000065 - 0000000000000065] | Motherboard resources |
| [0000000000000067 - 0000000000000067] | Motherboard resources |
| [0000000000000070 - 0000000000000070] | Motherboard resources |
| [0000000000000080 - 0000000000000080] | Motherboard resources |
| [0000000000000092 - 0000000000000092] | Motherboard resources |
| [00000000000000A0 - 00000000000000A1] | Programmable interrupt controller |
| [00000000000000A4 - 00000000000000A5] | Programmable interrupt controller |
| [00000000000000A8 - 00000000000000A9] | Programmable interrupt controller |
| [00000000000000AC - 00000000000000AD] | Programmable interrupt controller |
| [00000000000000B0 - 00000000000000B1] | Programmable interrupt controller |
| [00000000000000B2 - 00000000000000B3] | Motherboard resources |
| [00000000000000B4 - 00000000000000B5] | Programmable interrupt controller |
| [00000000000000B8 - 00000000000000B9] | Programmable interrupt controller |
| [00000000000000BC - 00000000000000BD] | Programmable interrupt controller |
| [00000000000000C0 - 00000000000000C7] | Fintek Communications Port (COM6) |
| [00000000000000D0 - 00000000000000D7] | Fintek Communications Port (COM5) |
| [00000000000000E8 - 00000000000000EF] | Fintek Communications Port (COM4) |
| [00000000000000F8 - 00000000000000FF] | Fintek Communications Port (COM2) |
| [000000000000003E8 - 000000000000003EF] | Fintek Communications Port (COM3) |
| [000000000000003F8 - 000000000000003FF] | Fintek Communications Port (COM1) |
| [000000000000004D0 - 000000000000004D1] | Programmable interrupt controller |
| [00000000000000680 - 0000000000000069F] | Motherboard resources |
| [00000000000000A00 - 00000000000000A0F] | Motherboard resources |
| [00000000000000A10 - 00000000000000A1F] | Motherboard resources |
| [00000000000000A20 - 00000000000000A2F] | Motherboard resources |
| [00000000000000D00 - 00000000000000FFF] | PCI Express Root Complex |
| [0000000000000164E - 0000000000000164F] | Motherboard resources |
| [00000000000001854 - 00000000000001857] | Motherboard resources |
| [00000000000002000 - 000000000000020FF] | Motherboard resources |
| [00000000000003000 - 00000000000003FFF] | Intel(R) PCI Express Root Port #1 - 7AB8 |
| [00000000000004000 - 0000000000000403F] | Intel(R) UHD Graphics 770 |
| [00000000000004060 - 0000000000000407F] | Standard SATA AHCI Controller |
| [00000000000004080 - 00000000000004083] | Standard SATA AHCI Controller |
| [00000000000004090 - 00000000000004097] | Standard SATA AHCI Controller |
| [0000000000000FFF8 - 0000000000000FFF] | Intel(R) Active Management Technology - SOL (COM7) |

A.2 IRQ Mapping Chart

The screenshot shows the Windows Device Manager window for a system named 'DESKTOP-KCVUBIL'. The 'Interrupt request (IRQ)' folder is expanded, displaying a list of devices and their assigned IRQs. The devices are as follows:

| Device Name | IRQ |
|-----------------------------------|-----------------------|
| System timer | (ISA) 0x00000000 (00) |
| Fintek Communications Port (COM2) | (ISA) 0x00000003 (03) |
| Fintek Communications Port (COM1) | (ISA) 0x00000004 (04) |
| Fintek Communications Port (COM3) | (ISA) 0x0000000B (11) |
| Fintek Communications Port (COM4) | (ISA) 0x0000000B (11) |
| Fintek Communications Port (COM5) | (ISA) 0x0000000B (11) |
| Fintek Communications Port (COM6) | (ISA) 0x0000000B (11) |
| Microsoft ACPI-Compliant System | (ISA) 0x00000037 (55) |
| Microsoft ACPI-Compliant System | (ISA) 0x00000038 (56) |
| Microsoft ACPI-Compliant System | (ISA) 0x00000039 (57) |
| Microsoft ACPI-Compliant System | (ISA) 0x0000003A (58) |
| Microsoft ACPI-Compliant System | (ISA) 0x0000003B (59) |
| Microsoft ACPI-Compliant System | (ISA) 0x0000003C (60) |
| Microsoft ACPI-Compliant System | (ISA) 0x0000003D (61) |
| Microsoft ACPI-Compliant System | (ISA) 0x0000003E (62) |
| Microsoft ACPI-Compliant System | (ISA) 0x0000003F (63) |
| Microsoft ACPI-Compliant System | (ISA) 0x00000040 (64) |
| Microsoft ACPI-Compliant System | (ISA) 0x00000041 (65) |
| Microsoft ACPI-Compliant System | (ISA) 0x00000042 (66) |
| Microsoft ACPI-Compliant System | (ISA) 0x00000043 (67) |
| Microsoft ACPI-Compliant System | (ISA) 0x00000044 (68) |
| Microsoft ACPI-Compliant System | (ISA) 0x00000045 (69) |
| Microsoft ACPI-Compliant System | (ISA) 0x00000046 (70) |
| Microsoft ACPI-Compliant System | (ISA) 0x00000047 (71) |
| Microsoft ACPI-Compliant System | (ISA) 0x00000048 (72) |
| Microsoft ACPI-Compliant System | (ISA) 0x00000049 (73) |
| Microsoft ACPI-Compliant System | (ISA) 0x0000004A (74) |
| Microsoft ACPI-Compliant System | (ISA) 0x0000004B (75) |
| Microsoft ACPI-Compliant System | (ISA) 0x0000004C (76) |
| Microsoft ACPI-Compliant System | (ISA) 0x0000004D (77) |
| Microsoft ACPI-Compliant System | (ISA) 0x0000004E (78) |
| Microsoft ACPI-Compliant System | (ISA) 0x0000004F (79) |
| Microsoft ACPI-Compliant System | (ISA) 0x00000050 (80) |
| Microsoft ACPI-Compliant System | (ISA) 0x00000051 (81) |
| Microsoft ACPI-Compliant System | (ISA) 0x00000052 (82) |
| Microsoft ACPI-Compliant System | (ISA) 0x00000053 (83) |
| Microsoft ACPI-Compliant System | (ISA) 0x00000054 (84) |
| Microsoft ACPI-Compliant System | (ISA) 0x00000055 (85) |
| Microsoft ACPI-Compliant System | (ISA) 0x00000056 (86) |
| Microsoft ACPI-Compliant System | (ISA) 0x00000057 (87) |
| Microsoft ACPI-Compliant System | (ISA) 0x00000058 (88) |
| Microsoft ACPI-Compliant System | (ISA) 0x00000059 (89) |
| Microsoft ACPI-Compliant System | (ISA) 0x0000005A (90) |
| Microsoft ACPI-Compliant System | (ISA) 0x0000005B (91) |
| Microsoft ACPI-Compliant System | (ISA) 0x0000005C (92) |
| Microsoft ACPI-Compliant System | (ISA) 0x0000005D (93) |
| Microsoft ACPI-Compliant System | (ISA) 0x0000005E (94) |
| Microsoft ACPI-Compliant System | (ISA) 0x0000005F (95) |
| Microsoft ACPI-Compliant System | (ISA) 0x00000060 (96) |

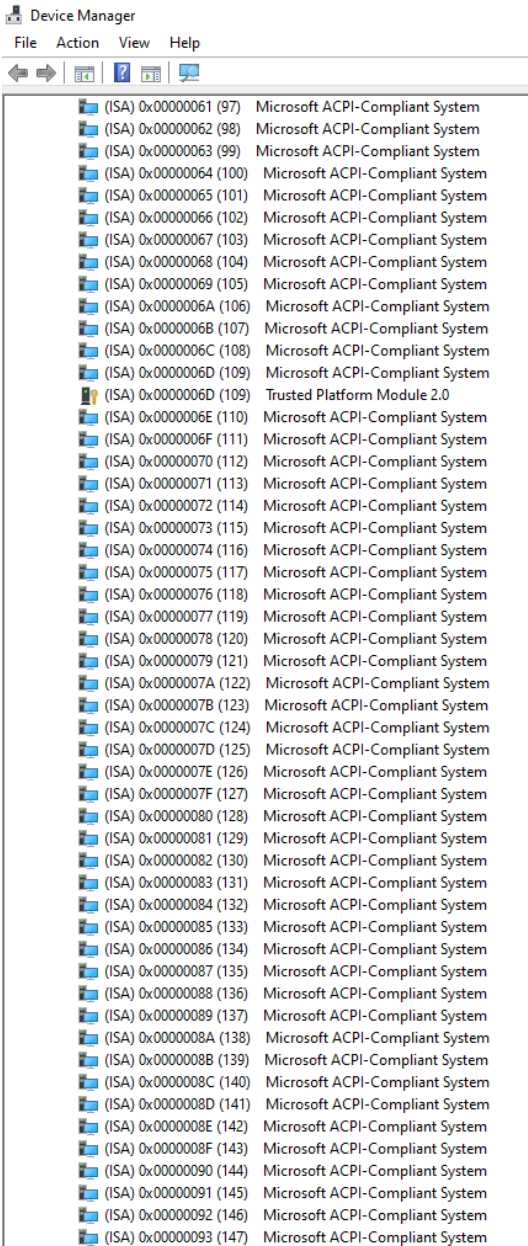

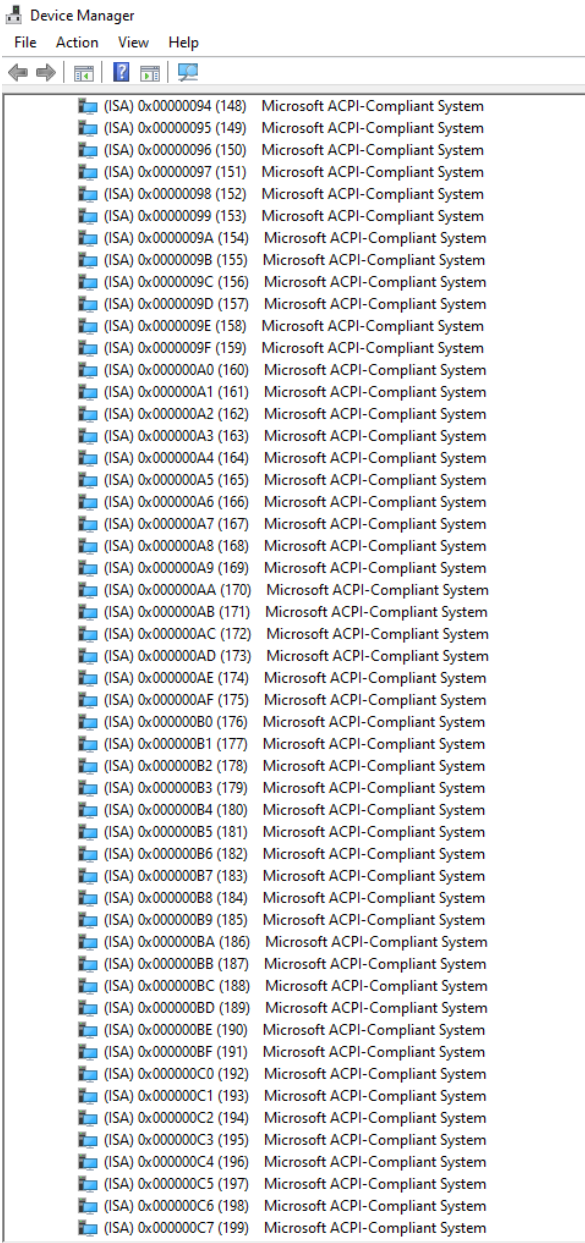

Device Manager

File Action View Help

| | |
|------------------------|---------------------------------|
| (ISA) 0x000000C8 (200) | Microsoft ACPI-Compliant System |
| (ISA) 0x000000C9 (201) | Microsoft ACPI-Compliant System |
| (ISA) 0x000000CA (202) | Microsoft ACPI-Compliant System |
| (ISA) 0x000000CB (203) | Microsoft ACPI-Compliant System |
| (ISA) 0x000000CC (204) | Microsoft ACPI-Compliant System |
| (ISA) 0x00000100 (256) | Microsoft ACPI-Compliant System |
| (ISA) 0x00000101 (257) | Microsoft ACPI-Compliant System |
| (ISA) 0x00000102 (258) | Microsoft ACPI-Compliant System |
| (ISA) 0x00000103 (259) | Microsoft ACPI-Compliant System |
| (ISA) 0x00000104 (260) | Microsoft ACPI-Compliant System |
| (ISA) 0x00000105 (261) | Microsoft ACPI-Compliant System |
| (ISA) 0x00000106 (262) | Microsoft ACPI-Compliant System |
| (ISA) 0x00000107 (263) | Microsoft ACPI-Compliant System |
| (ISA) 0x00000108 (264) | Microsoft ACPI-Compliant System |
| (ISA) 0x00000109 (265) | Microsoft ACPI-Compliant System |
| (ISA) 0x0000010A (266) | Microsoft ACPI-Compliant System |
| (ISA) 0x0000010B (267) | Microsoft ACPI-Compliant System |
| (ISA) 0x0000010C (268) | Microsoft ACPI-Compliant System |
| (ISA) 0x0000010D (269) | Microsoft ACPI-Compliant System |
| (ISA) 0x0000010E (270) | Microsoft ACPI-Compliant System |
| (ISA) 0x0000010F (271) | Microsoft ACPI-Compliant System |
| (ISA) 0x00000110 (272) | Microsoft ACPI-Compliant System |
| (ISA) 0x00000111 (273) | Microsoft ACPI-Compliant System |
| (ISA) 0x00000112 (274) | Microsoft ACPI-Compliant System |
| (ISA) 0x00000113 (275) | Microsoft ACPI-Compliant System |
| (ISA) 0x00000114 (276) | Microsoft ACPI-Compliant System |
| (ISA) 0x00000115 (277) | Microsoft ACPI-Compliant System |
| (ISA) 0x00000116 (278) | Microsoft ACPI-Compliant System |
| (ISA) 0x00000117 (279) | Microsoft ACPI-Compliant System |
| (ISA) 0x00000118 (280) | Microsoft ACPI-Compliant System |
| (ISA) 0x00000119 (281) | Microsoft ACPI-Compliant System |
| (ISA) 0x0000011A (282) | Microsoft ACPI-Compliant System |
| (ISA) 0x0000011B (283) | Microsoft ACPI-Compliant System |
| (ISA) 0x0000011C (284) | Microsoft ACPI-Compliant System |
| (ISA) 0x0000011D (285) | Microsoft ACPI-Compliant System |
| (ISA) 0x0000011E (286) | Microsoft ACPI-Compliant System |
| (ISA) 0x0000011F (287) | Microsoft ACPI-Compliant System |
| (ISA) 0x00000120 (288) | Microsoft ACPI-Compliant System |
| (ISA) 0x00000121 (289) | Microsoft ACPI-Compliant System |
| (ISA) 0x00000122 (290) | Microsoft ACPI-Compliant System |
| (ISA) 0x00000123 (291) | Microsoft ACPI-Compliant System |
| (ISA) 0x00000124 (292) | Microsoft ACPI-Compliant System |
| (ISA) 0x00000125 (293) | Microsoft ACPI-Compliant System |
| (ISA) 0x00000126 (294) | Microsoft ACPI-Compliant System |
| (ISA) 0x00000127 (295) | Microsoft ACPI-Compliant System |
| (ISA) 0x00000128 (296) | Microsoft ACPI-Compliant System |
| (ISA) 0x00000129 (297) | Microsoft ACPI-Compliant System |
| (ISA) 0x0000012A (298) | Microsoft ACPI-Compliant System |
| (ISA) 0x0000012B (299) | Microsoft ACPI-Compliant System |
| (ISA) 0x0000012C (300) | Microsoft ACPI-Compliant System |
| (ISA) 0x0000012D (301) | Microsoft ACPI-Compliant System |
| (ISA) 0x0000012E (302) | Microsoft ACPI-Compliant System |

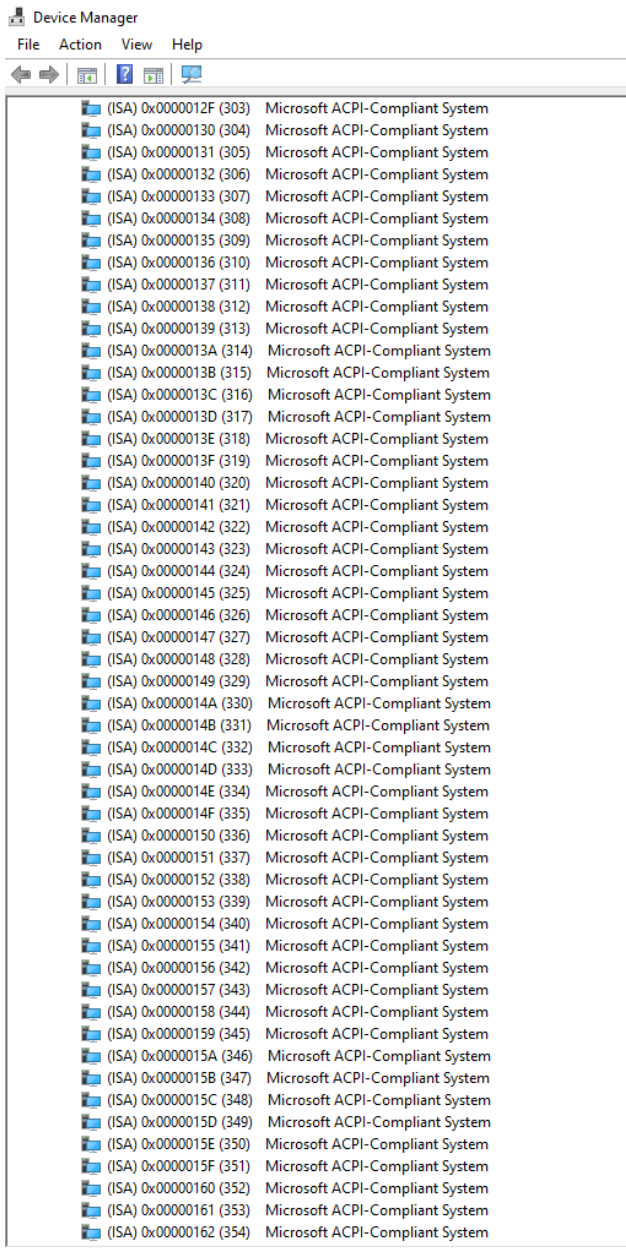

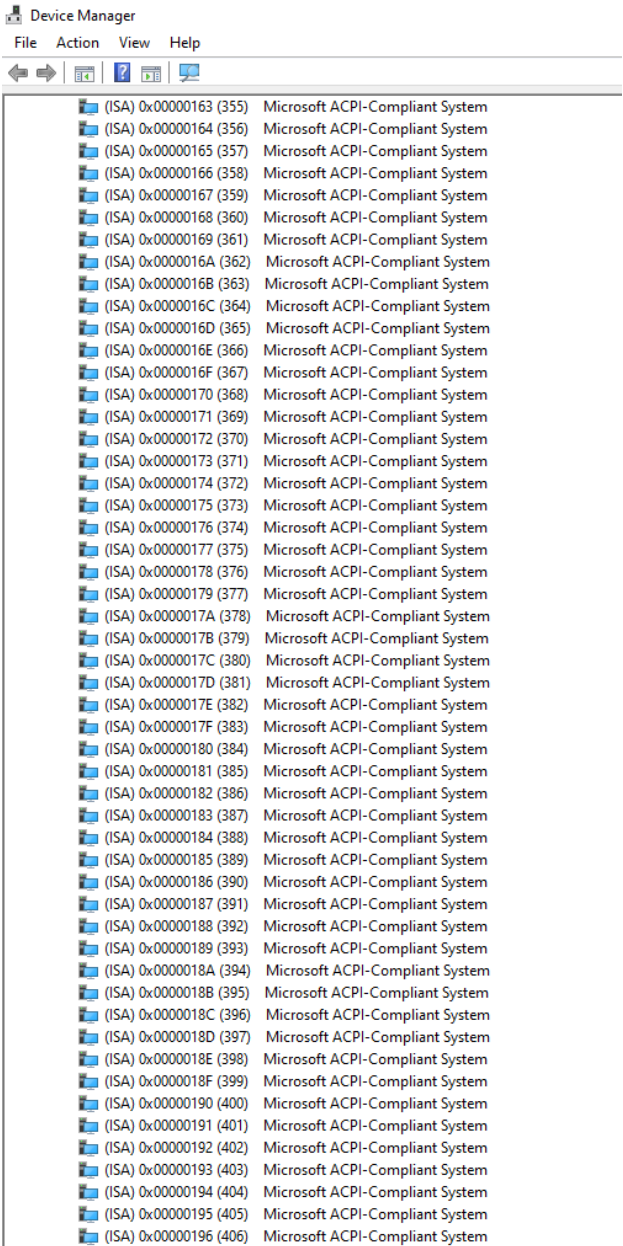

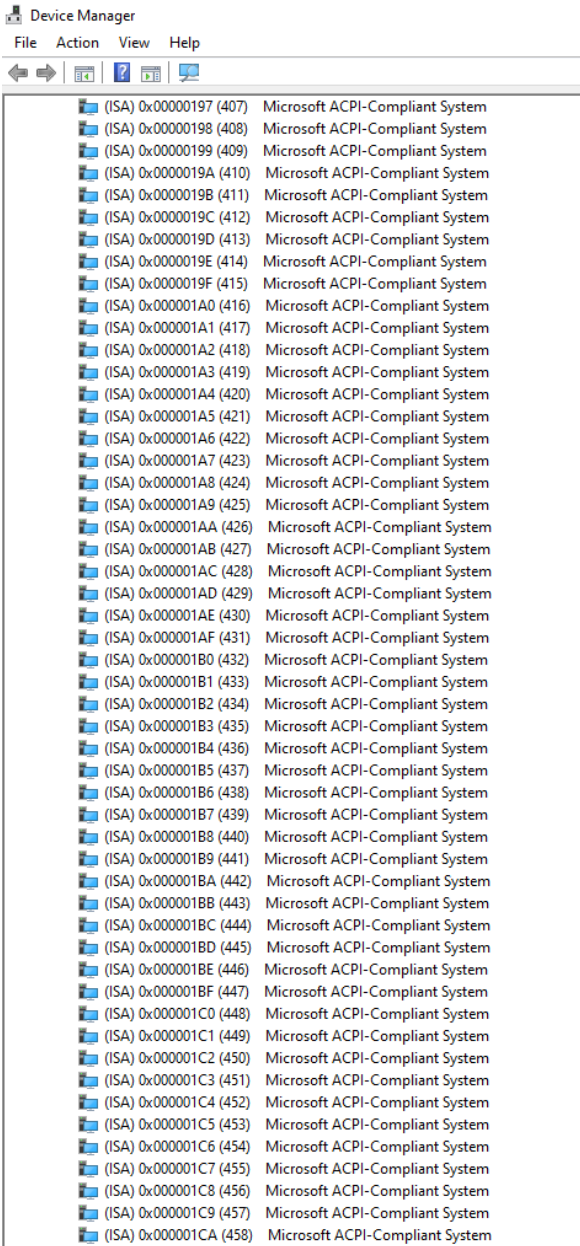

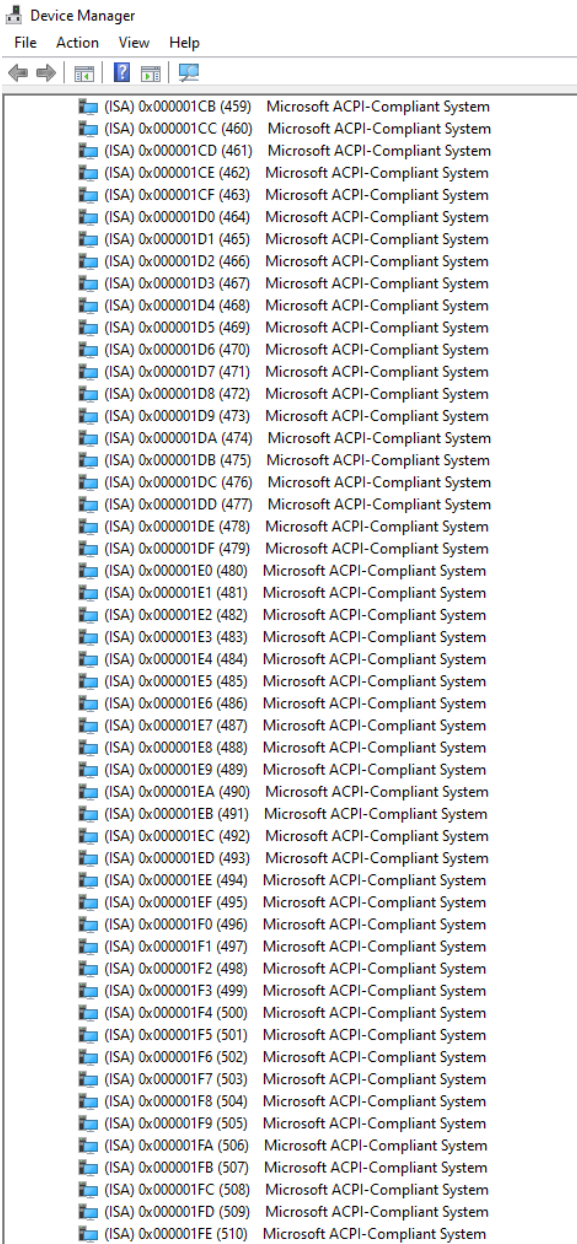

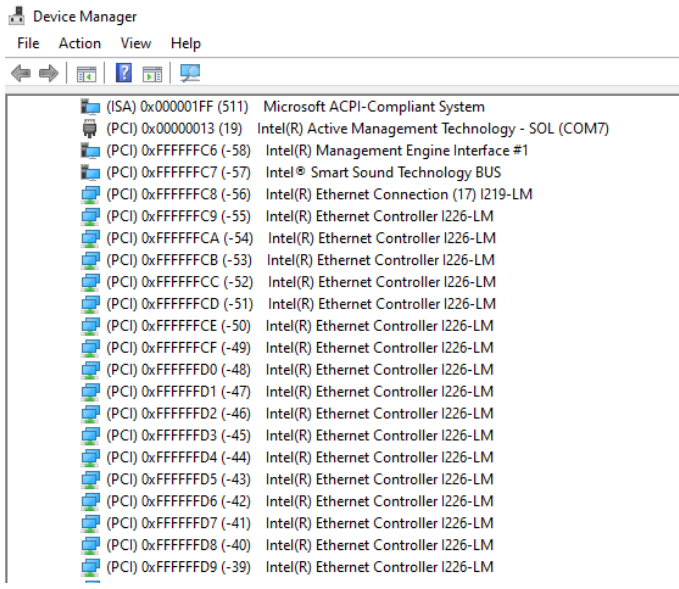





































| | | |
|--|------------------------|---|
|  | (PCI) 0xFFFFFDA (-38) | Intel(R) Ethernet Controller I226-LM #3 |
|  | (PCI) 0xFFFFFDB (-37) | Intel(R) Ethernet Controller I226-LM #3 |
|  | (PCI) 0xFFFFFDC (-36) | Intel(R) Ethernet Controller I226-LM #3 |
|  | (PCI) 0xFFFFFDD (-35) | Intel(R) Ethernet Controller I226-LM #3 |
|  | (PCI) 0xFFFFFDE (-34) | Intel(R) Ethernet Controller I226-LM #3 |
|  | (PCI) 0xFFFFFDF (-33) | Intel(R) Ethernet Controller I226-LM #3 |
|  | (PCI) 0xFFFFFDE0 (-32) | Intel(R) Ethernet Controller I226-LM #3 |
|  | (PCI) 0xFFFFFDE1 (-31) | Intel(R) Ethernet Controller I226-LM #3 |
|  | (PCI) 0xFFFFFDE2 (-30) | Intel(R) Ethernet Controller I226-LM #3 |
|  | (PCI) 0xFFFFFDE3 (-29) | Intel(R) Ethernet Controller I226-LM #3 |
|  | (PCI) 0xFFFFFDE4 (-28) | Intel(R) Ethernet Controller I226-LM #3 |
|  | (PCI) 0xFFFFFDE5 (-27) | Intel(R) Ethernet Controller I226-LM #3 |
|  | (PCI) 0xFFFFFDE6 (-26) | Intel(R) Ethernet Controller I226-LM #3 |
|  | (PCI) 0xFFFFFDE7 (-25) | Intel(R) Ethernet Controller I226-LM #3 |
|  | (PCI) 0xFFFFFDE8 (-24) | Intel(R) Ethernet Controller I226-LM #3 |
|  | (PCI) 0xFFFFFDE9 (-23) | Intel(R) Ethernet Controller I226-LM #3 |
|  | (PCI) 0xFFFFFDEA (-22) | Intel(R) Ethernet Controller I226-LM #3 |
|  | (PCI) 0xFFFFFDEB (-21) | Intel(R) Ethernet Controller I226-LM #2 |
|  | (PCI) 0xFFFFFDEC (-20) | Intel(R) Ethernet Controller I226-LM #2 |
|  | (PCI) 0xFFFFFDED (-19) | Intel(R) Ethernet Controller I226-LM #2 |
|  | (PCI) 0xFFFFFDEE (-18) | Intel(R) Ethernet Controller I226-LM #2 |
|  | (PCI) 0xFFFFFDEF (-17) | Intel(R) Ethernet Controller I226-LM #2 |
|  | (PCI) 0xFFFFFDF0 (-16) | Intel(R) Ethernet Controller I226-LM #2 |
|  | (PCI) 0xFFFFFDF1 (-15) | Intel(R) Ethernet Controller I226-LM #2 |
|  | (PCI) 0xFFFFFDF2 (-14) | Intel(R) Ethernet Controller I226-LM #2 |
|  | (PCI) 0xFFFFFDF3 (-13) | Intel(R) Ethernet Controller I226-LM #2 |
|  | (PCI) 0xFFFFFDF4 (-12) | Intel(R) Ethernet Controller I226-LM #2 |
|  | (PCI) 0xFFFFFDF5 (-11) | Intel(R) Ethernet Controller I226-LM #2 |
|  | (PCI) 0xFFFFFDF6 (-10) | Intel(R) Ethernet Controller I226-LM #2 |
|  | (PCI) 0xFFFFFDF7 (-9) | Intel(R) Ethernet Controller I226-LM #2 |
|  | (PCI) 0xFFFFFDF8 (-8) | Intel(R) Ethernet Controller I226-LM #2 |
|  | (PCI) 0xFFFFFDF9 (-7) | Intel(R) Ethernet Controller I226-LM #2 |
|  | (PCI) 0xFFFFFDFA (-6) | Intel(R) Ethernet Controller I226-LM #2 |
|  | (PCI) 0xFFFFDFB (-5) | Intel(R) Ethernet Controller I226-LM #2 |
|  | (PCI) 0xFFFFDFC (-4) | Intel(R) USB 3.20 eXtensible Host Controller - 1.20 (Microsoft) |
|  | (PCI) 0xFFFFDFD (-3) | Intel(R) UHD Graphics 770 |
|  | (PCI) 0xFFFFDFE (-2) | Standard SATA AHCI Controller |

A.3 Memory Address Map

The screenshot shows the Windows Device Manager window for a system named 'DESKTOP-KCVUBIL'. The 'Memory' category is expanded, displaying a list of hardware devices with their memory addresses and names. The devices listed are:

- [0000000000A0000 - 0000000000BFFFFF] PCI Express Root Complex
- [0000000080400000 - 0000000080DFFFFF] Intel(R) PCI Express Root Port #1 - 7AB8
- [0000000080400000 - 0000000080BFFFFF] PCI Express Root Complex
- [0000000080E00000 - 0000000080FFFFFF] Intel(R) PCI Express Root Port #6 - 7ABD
- [0000000080EFC000 - 0000000080EFFFFF] Intel(R) Ethernet Controller I226-LM
- [0000000080F00000 - 0000000080FFFFFF] Intel(R) Ethernet Controller I226-LM
- [0000000081000000 - 00000000811FFFFF] Intel(R) PCI Express Root Port #5 - 7ABC
- [00000000810FC000 - 00000000810FFFFF] Intel(R) Ethernet Controller I226-LM #3
- [0000000081100000 - 00000000811FFFFF] Intel(R) Ethernet Controller I226-LM #3
- [0000000081200000 - 00000000812FFFFF] Intel(R) Ethernet Controller I226-LM #2
- [0000000081200000 - 00000000813FFFFF] Intel(R) PCI Express Root Port #4 - 7ABB
- [0000000081300000 - 0000000081303FFF] Intel(R) Ethernet Controller I226-LM #2
- [0000000081420000 - 0000000081421FFF] Standard SATA AHCI Controller
- [0000000081422000 - 0000000081422FFF] Standard SATA AHCI Controller
- [0000000081423000 - 00000000814230FF] Standard SATA AHCI Controller
- [000000008BFDF000 - 000000008BFFDFFFFF] Intel(R) Active Management Technology - SOL (COM7)
- [000000008BFDE000 - 000000008BFFDFFFFF] Intel(R) Ethernet Connection (17) I219-LM
- [00000000C0000000 - 00000000C0FFFFFF] Motherboard resources
- [00000000FE010000 - 00000000FE010FFFFF] Intel(R) SPI (flash) Controller - 7AA4
- [00000000FED00000 - 00000000FED003FF] High precision event timer
- [00000000FED20000 - 00000000FED7FFFF] Motherboard resources
- [00000000FED40000 - 00000000FED44FFF] Trusted Platform Module 2.0
- [00000000FED45000 - 00000000FED8FFFF] Motherboard resources
- [00000000FED90000 - 00000000FED93FFF] Motherboard resources
- [00000000FEDA0000 - 00000000FEDA0FFF] Motherboard resources
- [00000000FEDA1000 - 00000000FEDA1FFF] Motherboard resources
- [00000000FEDC0000 - 00000000FEDC7FFF] Motherboard resources
- [00000000FEE00000 - 00000000FEE0FFFFF] Motherboard resources
- [0000000400000000 - 0000000400FFFFFFF] Intel(R) UHD Graphics 770
- [0000000600000000 - 00000006000FFFFFFF] Intel(R) UHD Graphics 770
- [0000006001100000 - 000000600110FFFFF] Intel(R) USB 3.20 eXtensible Host Controller - 1.20 (Microsoft)
- [0000007FFFEB0000 - 0000007FFFEBFFFFF] Intel(R) Management Engine Interface #1
- [0000007FFFEC0000 - 0000007FFFECFFFFF] Intel® Smart Sound Technology BUS
- [0000007FFFF00000 - 0000007FFFF0FFFFF] Intel® Smart Sound Technology BUS

A.4 Large Memory Address Map

