

BOXER-6839-CFL

Fanless Embedded Box PC

User's Manual 1st Ed

Copyright Notice

This document is copyrighted, 2021. All rights are reserved. The original manufacturer reserves the right to make improvements to the products described in this manual at any time without notice.

No part of this manual may be reproduced, copied, translated, or transmitted in any form or by any means without the prior written permission of the original manufacturer. Information provided in this manual is intended to be accurate and reliable. However, the original manufacturer assumes no responsibility for its use, or for any infringements upon the rights of third parties that may result from its use.

The material in this document is for product information only and is subject to change without notice. While reasonable efforts have been made in the preparation of this document to assure its accuracy, AAEON assumes no liabilities resulting from errors or omissions in this document, or from the use of the information contained herein.

AAEON reserves the right to make changes in the product design without notice to its users.

Acknowledgement

All other product name or trademarks are properties of their respective owners.

- Microsoft Windows® is a registered trademark of Microsoft Corp.
- Intel®, Pentium®, Celeron®, and Xeon® are registered trademarks of Intel Corporation
- Intel Core™ is a trademark of Intel Corporation

All other product names or trademarks are properties of their respective owners. The publisher of this document does not assume nor imply ownership of any trademarked product not listed herein.

Packing List

Before setting up your product, please make sure the following items have been shipped:

Item	Quantity
● BOXER-6839-CFL	1
● Wallmount bracket	2
● Screw Package	1
● 3 Pin DC-In Power Connector	1

If any of these items are missing or damaged, please contact your distributor or sales representative immediately.

About this Document

This User's Manual contains all the essential information, such as detailed descriptions and explanations on the product's hardware and software features (if any), its specifications, dimensions, jumper/connector settings/definitions, and driver installation instructions (if any), to facilitate users in setting up their product.

Users may refer to the product page at AAEON.com for the latest version of this document.

Safety Precautions

Please read the following safety instructions carefully. It is advised that you keep this manual for future references

1. All cautions and warnings on the device should be noted.
2. Make sure the power source matches the power rating of the device.
3. Position the power cord so that people cannot step on it. Do not place anything over the power cord.
4. Always completely disconnect the power before working on the system's hardware.
5. No connections should be made when the system is powered as a sudden rush of power may damage sensitive electronic components.
6. If the device is not to be used for a long time, disconnect it from the power supply to avoid damage by transient over-voltage.
7. Always disconnect this device from any power supply before cleaning.
8. While cleaning, use a damp cloth instead of liquid or spray detergents.
9. Make sure the device is installed near a power outlet and is easily accessible.
10. Keep this device away from humidity.
11. Place the device on a solid surface during installation to prevent falls.
12. Do not cover the openings on the device to ensure optimal heat dissipation.
13. Watch out for high temperatures when the system is running.
14. Do not touch the heat sink or heat spreader when the system is running
15. Never pour any liquid into the openings. This could cause fire or electric shock.
16. As most electronic components are sensitive to static electrical charge, be sure to ground yourself to prevent static charge when installing the internal components. Use a grounding wrist strap and contain all electronic components in any static-shielded containers.

17. If any of the following situations arises, please contact our service personnel:
 - i. Damaged power cord or plug
 - ii. Liquid intrusion to the device
 - iii. Exposure to moisture
 - iv. Device is not working as expected or in a manner as described in this manual
 - v. The device is dropped or damaged
 - vi. Any obvious signs of damage displayed on the device
18. Do not leave this device in an uncontrolled environment with temperatures beyond the device's permitted storage temperatures (see chapter 1) to prevent damage.
19. Do NOT disassemble the motherboard so as not to damage the system or void your warranty.
20. If the thermal pad had been damaged, please contact AAEON's salesperson to purchase a new one. Do NOT use those of other brands.
21. The Hex Cylinder Coppers on the front panel are not removable.
22. Repeatedly assemble and disassemble the system may cause damages to the exterior paint and surface and screw holes.
23. Use the right size screwdriver.
24. Use the screwdriver correctly to remove screws from the system.

FCC Statement

Warning!



This device complies with Part 15 FCC Rules. Operation is subject to the following two conditions: (1) this device may not cause harmful interference, and (2) this device must accept any interference received including interference that may cause undesired operation.

Caution:

There is a danger of explosion if the battery is incorrectly replaced. Replace only with the same or equivalent type recommended by the manufacturer. Dispose of used batteries according to the manufacturer's instructions and your local government's recycling or disposal directives.

Attention:

Il y a un risque d'explosion si la batterie est remplacée de façon incorrecte. Ne la remplacer qu'avec le même modèle ou équivalent recommandé par le constructeur. Recycler les batteries usées en accord avec les instructions du fabricant et les directives gouvernementales de recyclage.

产品中有毒有害物质或元素名称及含量

AAEON System

QO4-381 Rev.A0

部件名称	有毒有害物质或元素					
	铅 (Pb)	汞 (Hg)	镉 (Cd)	六价铬 (Cr(VI))	多溴联苯 (PBB)	多溴二苯 醚(PBDE)
印刷电路板 及其电子组件	×	○	○	○	○	○
外部信号 连接器及线材	×	○	○	○	○	○
外壳	○	○	○	○	○	○
中央处理器 与内存	×	○	○	○	○	○
硬盘	×	○	○	○	○	○
液晶模块	×	×	○	○	○	○
光驱	×	○	○	○	○	○
触控模块	×	○	○	○	○	○
电源	×	○	○	○	○	○
电池	×	○	○	○	○	○

本表格依据 SJ/T 11364 的规定编制。

○：表示该有毒有害物质在该部件所有均质材料中的含量均在 GB/T 26572 标准规定的限量要求以下。

×：表示该有害物质的某一均质材料超出了 GB/T 26572 的限量要求，然而该部件

仍符合欧盟指令 2011/65/EU 的规范。

备注：

- 一、此产品所标示之环保使用期限，系指在一般正常使用状况下。
- 二、上述部件物质中央处理器、内存、硬盘、光驱、电源为选购品。
- 三、上述部件物质液晶模块、触控模块仅一体机产品适用。

Hazardous and Toxic Materials List

AAEON System

QO4-381 Rev.A0

Component Name	Hazardous or Toxic Materials or Elements					
	Lead (Pb)	Mercury (Hg)	Cadmium (Cd)	Hexavalent Chromium (Cr(VI))	Polybrominated biphenyls (PBBS)	Polybrominated diphenyl ethers (PBDES)
PCB and Components	X	O	O	O	O	O
Wires & Connectors for Ext.Connections	X	O	O	O	O	O
Chassis	O	O	O	O	O	O
CPU & RAM	X	O	O	O	O	O
HDD Drive	X	O	O	O	O	O
LCD Module	X	X	O	O	O	O
Optical Drive	X	O	O	O	O	O
Touch Control Module	X	O	O	O	O	O
PSU	X	O	O	O	O	O
Battery	X	O	O	O	O	O

This form is prepared in compliance with the provisions of SJ/T 11364.

O: The level of toxic or hazardous materials present in this component and its parts is below the limit specified by GB/T 26572.

X: The level of toxic of hazardous materials present in the component exceed the limits specified by GB/T 26572, but is still in compliance with EU Directive 2011/65/EU (RoHS 2).

Notes:

1. The Environment Friendly Use Period indicated by labelling on this product is applicable only to use under normal conditions.
2. Individual components including the CPU, RAM/memory, HDD, optical drive, and PSU are optional.
3. LCD Module and Touch Control Module only applies to certain products which feature these components.

Table of Contents

- Chapter 1 - Product Specifications 1**
 - 1.1 Specifications..... 2
- Chapter 2 – Hardware Information 4**
 - 2.1 BOXER-6839-CFL Dimensions..... 5
 - 2.2 Jumpers and Connectors 8
 - 2.3 List of Jumpers 9
 - 2.3.1 Setting Jumpers..... 9
 - 2.3.2 Auto Power Button Selection (AT/ATX Mode) (JP19) 10
 - 2.3.3 CMOS Control Selection (JP24) 10
 - 2.4 List of Connectors 11
 - 2.4.1 Phoenix Connector Power Input (CN2)..... 12
 - 2.4.2 SPI Flash Port (CN7) 13
 - 2.4.3 PCIe [x4] Slot (CN8)..... 13
 - 2.4.4 LAN (RJ-45) + Dual USB3.2 Gen 1 (CN14)..... 16
 - 2.4.5 LAN (RJ-45) + Dual USB3.2 Gen 1 (CN15)..... 18
 - 2.4.6 Audio Connector (CN18)..... 19
 - 2.4.7 Digital IO Port (CN43)..... 20
 - 2.4.8 USB2.0 Wafer BOX (5P Pitch: 1.25mm) (CN 45,71,72) 21
 - 2.4.9 COM5 + COM6 Connector RS232/RS422/RS485 (CN49) 21
 - 2.4.10 COM1 + COM2 Connector RS232/RS422/RS485 (CN60)..... 22
 - 2.4.11 COM3 + COM4 Connector RS232/RS422/RS485 (CN62) 24
 - 2.4.12 LAN (RJ-45) + Dual USB3.2 Gen 1 (CN73) 25
 - 2.4.13 LAN (RJ-45) + Dual USB3.2 Gen 1 (CN74) 26
 - 2.4.14 HDMI Port (CN75) 28
 - 2.4.15 HDMI Port (CN76) 29
 - 2.4.16 LPC Port (LPC1) 30

2.4.17	Mini Card Slot (Full-Sized) (PCIe1).....	31
2.4.18	Mini Card Slot with mSATA (Full Sized) (PCIe2).....	33
2.4.19	SATA PWR (PWR 1,2).....	36
2.4.20	SATA Port (SATA 3,4).....	36
2.4.21	SIM Slot (SIM1).....	37
2.5	CPU Installation.....	38
2.6	Expansion Card Installation.....	40
2.7	2.5" SATA Drive Installation.....	42
2.8	Wallmount Assembly.....	44
Chapter 3 - AMI BIOS Setup.....		45
3.1	System Test and Initialization.....	46
3.2	AMI BIOS Setup.....	47
3.3	Setup Submenu: Main.....	48
3.4	Setup Submenu: Advanced.....	49
3.4.1	Advanced: Trusted Computing.....	50
3.4.2	Advanced: CPU Configuration.....	52
3.4.3	Advanced: PCH-FW Configuration.....	54
3.4.3.1	Firmware Update Configuration.....	55
3.4.3.2	PTT Configuration.....	56
3.4.4	Advanced: SATA Configuration.....	57
3.4.5	Advanced: USB Configuration.....	58
3.4.6	Advanced: Hardware Monitor.....	59
3.4.7	Advanced: SIO Configuration.....	60
3.4.7.1	Serial Port 1 Configuration.....	61
3.4.7.2	Serial Port 2 Configuration.....	62
3.4.7.3	Serial Port 3 Configuration.....	63
3.4.7.4	Serial Port 4 Configuration.....	64
3.4.7.5	Serial Port 5 Configuration.....	65

3.4.7.6	Serial Port 6 Configuration	66
3.4.8	Advanced: Network Stack Configuration	67
3.4.9	Advanced: Digital IO Port Configuration.....	70
3.4.10	Advanced: Power Management.....	71
3.5	Setup Submenu: Chipset.....	73
3.5.1	Chipset: System Agent (SA) Configuration	74
3.5.2	Chipset: PCH-IO Configuration	76
3.6	Setup Submenu: Security	78
3.6.1	Security: Secure Boot.....	79
3.6.1.1	Key Management.....	81
3.7	Setup Submenu: Boot.....	85
3.8	Setup Submenu: Save & Exit	86
Chapter 4	– Drivers Installation	87
4.1	Drivers Download and Installation.....	88
Appendix A	- Watchdog Timer Programming.....	90
A.1	Watchdog Timer Initial Program.....	91
Appendix B	- I/O Information.....	96
B.1	I/O Address Map.....	97
B.2	IRQ Mapping Chart	99
B.3	Memory Address Map	111
Appendix C	- Digital I/O Ports.....	112
C.1	Electrical Specifications for Digital I/O Ports	113
C.2	DIO Programming	114
C.3	Digital I/O Register.....	115
C.4	Digital I/O Sample Program.....	116
Appendix D	– Glue Removal Procedure.....	122
D.1	Removing Glue from Your System.....	123

Chapter 1

Product Specifications

1.1 Specifications

System

CPU	Intel® Xeon® E-2124G Intel® i9-9900T Intel® i7-9700TE Intel® i7-8700T Intel® i5-8500T Intel® i3-8100T Pentium® G5400T Celeron® G4900T
Chipset	C246
System Memory	DDR4-2666 SO-DIMM slot x 2 Up to 64GB, ECC or Non-ECC Supported
Display Interface	HDMI x 2
Storage Device	2.5" SATA HDD/SSD Bay x 2
Ethernet	RJ-45 x 4 for GbE LAN (i211 x 3, i219 x 1)
I/O	HDMI x 2 RJ-45 x 4 for GbE LAN (i211 x 3, i219 x 1) USB3.2 Gen 1 x 8 DB-9 x 6 for RS-232/422/485 Audio x 1 (MIC-in, Line-out) DB-15 for DIO 8 bit x 1 3-pin 10~35V Power Input x 1 Power Button x 1 Remote Power switch x 1 Reset Button x 1
Expansion	Full-size Mini Card x 1 (PCIe) Full-size Mini Card x 1 (PCIe/mSATA switch by BIOS, Default: mSATA) SIM slot x 1 PCI/PCI Express slot configuration: Riser card type 1: PCIe[x4] slot x 1 & PCIe[x1] x 1 Riser card type 2: PCIe[x4] slot x 1 & PCI x 1 Riser card type 3: PCI x 2

System

Indicator	HDD LED x 1 System LED x 1
OS Support	Windows® 10 64-bit Linux Ubuntu 20.04

Power Supply

Power Requirement	3-pin Phoenix DC Input 10~35V
-------------------	-------------------------------

Mechanical

Mounting	Wallmount
Dimensions (W x H x D)	264mm x 156mm x 125mm
Gross Weight	13.2 lbs. (6.0 kg)
Net Weight	9.9 lbs. (4.5 kg)

Environmental

Operating Temperature	-4°F ~131°F (-20°C ~ 55°C) with 0.5 m/s airflow (with TDP ≤ 35W CPU) -4°F~113°F (-20°C ~45°C) with 0.5 m/s airflow (with TDP > 35W CPU)
Storage Temperature	-49°F ~ 176°F (-45°C ~ 80°C)
Storage Humidity	5~95% @ 40°C, non-condensing
Anti-Vibration	5 Grms/ 5 ~ 500Hz/ operation –SSD
Certification	CE/FCC class A
Drop Testing	76 cm (1 corner, 3 edge, 6 surface)
Shock	With SSD: 50G at wallmount, half-sine, 11ms

Chapter 2

Hardware Information

2.1 BOXER-6839-CFL Dimensions

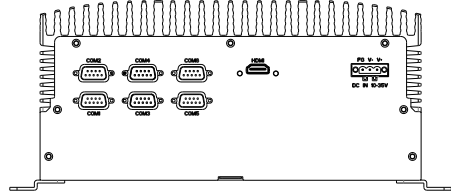
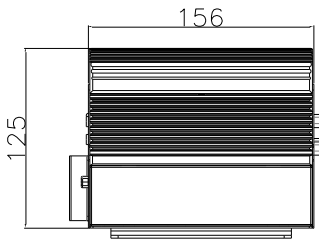
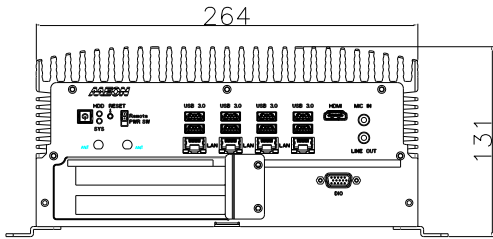
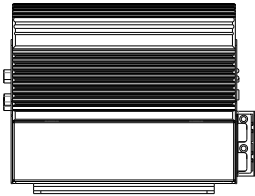
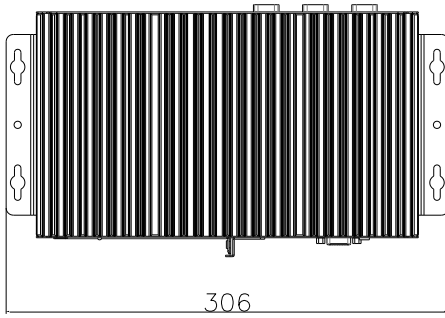

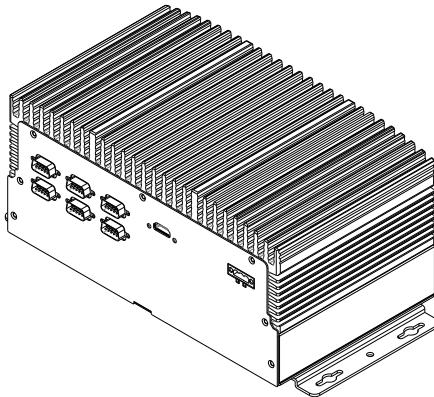
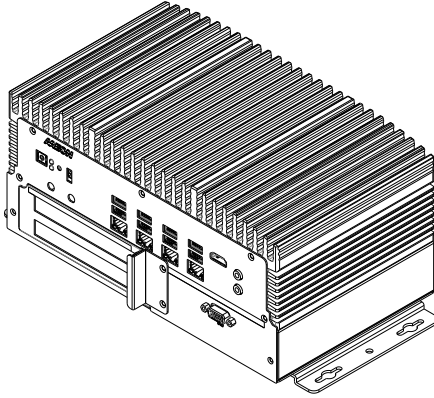
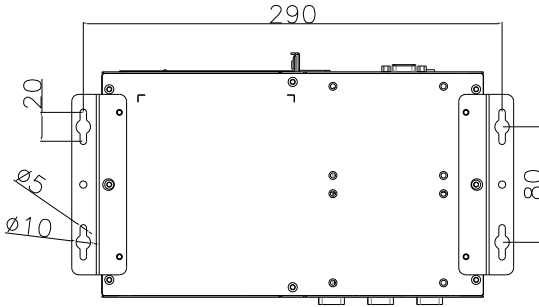

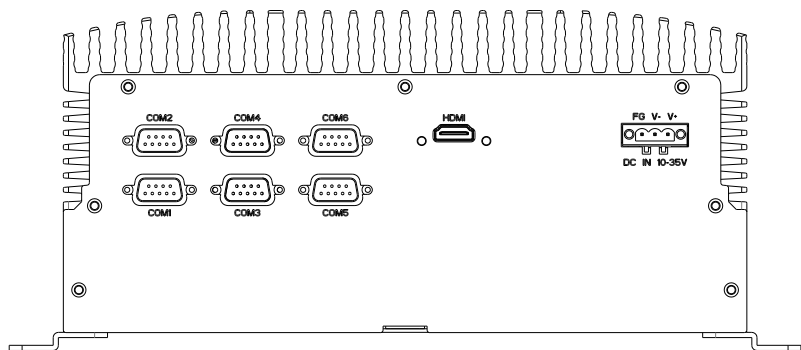
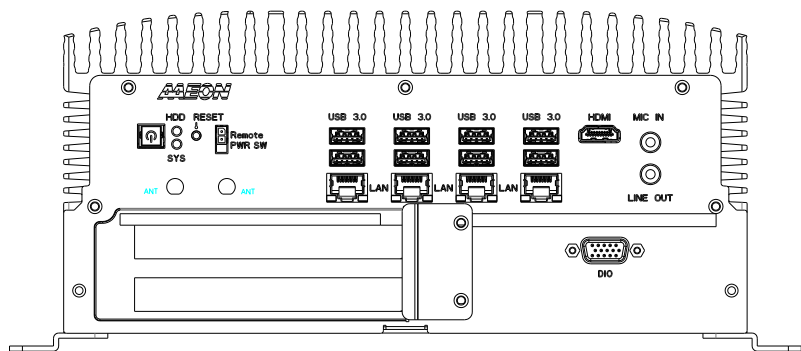

2.2 Jumpers and Connectors

Note: Board dimensions are 225mm x 151.5mm x 1.8mm

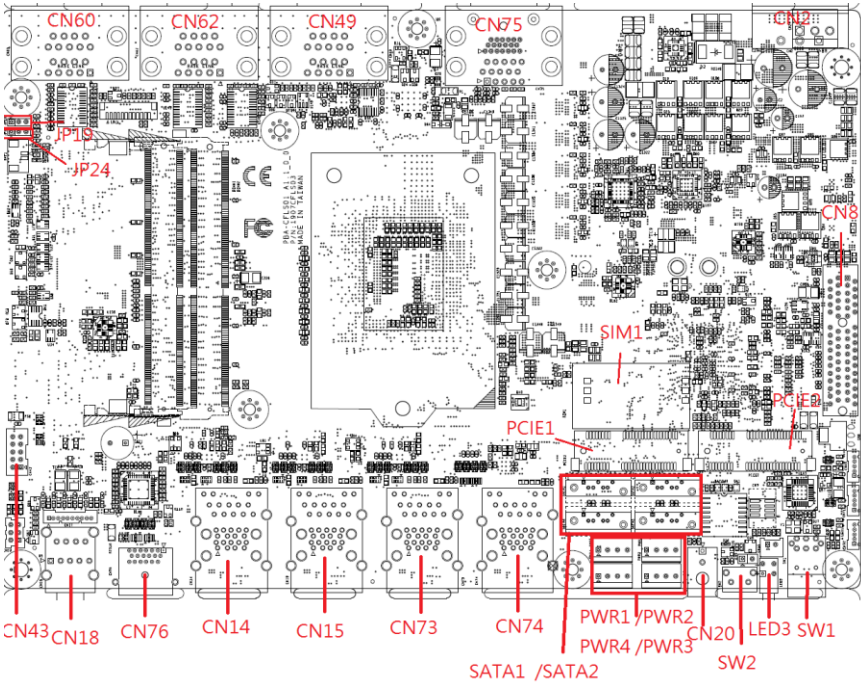

2.3 List of Jumpers

Please refer to the table below for all of the system's jumpers that you can configure for your application.

Label	Function
JP19	Auto-Power Button Selection (AT/ATX Mode)
JP24	CMOS Control Selection (Clear CMOS)

2.3.1 Setting Jumpers

The BOXER-6839-CFL comes with several jumpers which allow you to configure the system by either setting the jumper to "open" or "closed"; or by selecting certain pins. A closed jumper has two pins connected with a jumper clip, while an open jumper has no pins connected.

For jumpers with multiple pins, this guide uses "pins A-B" to notate which pins should be connected by a jumper clip. For example, "pins 1-2" means you should connect pins 1 and 2, while "pins 2-3" means you should connect pins 2 and 3.

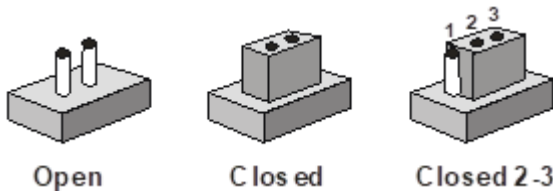

A pair of needle-nose pliers may be helpful when working with jumpers.

If you have any questions about how best to configure the system for your application, contact your AAEON representative or visit our website to talk with our support team.

2.3.2 Auto Power Button Selection (AT/ATX Mode) (JP19)

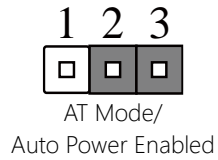
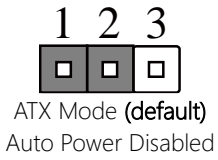

Note: Disable Auto Power Button JP19 (1-2) requires user to use power button JP19 (1-2) to power on the system.

2.3.3 CMOS Control Selection (JP24)

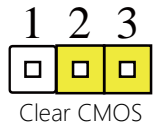
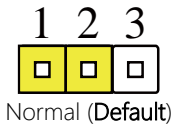

2.4 List of Connectors

Please refer to the table below for all of the system's connectors that you can configure for your application

Label	Function
BAT1	RTC Battery
CN2	Phoenix Connector Power Input
CN7	SPI flash port
CN8	PCIe [x4] Slot
CN14	LAN+USB3.2 Gen 1 x2 Connector
CN15	LAN+USB3.2 Gen 1 x2 Connector
CN18	Audio Connector
CN20	Remote Button
CN43	Digital IO Port
CN45	USB2.0 (HEADER)
CN49	COM5+COM6 Connector RS232/RS422/RS485
CN60	COM1+COM2 Connector RS232/RS422/RS485
CN62	COM3+COM4 Connector RS232/RS422/RS485
CN71	USB2.0 (HEADER)
CN72	USB2.0 (HEADER)
CN73	LAN+USB3.2 Gen 1 x2 Connector
CN74	LAN+USB3.2 Gen 1 x2 Connector
CN75	HDMI Port
CN76	HDMI Port
LPC1	LPC Port
PCIE1	Mini Card slot (full-sized)
PCIE2	Mini Card slot with mSATA (full-sized)
PWR1	SATA PWR Connector

Label	Function
PWR2	SATA PWR Connector
SATA3	SATA3
SATA4	SATA4
SIM1	SIM Card Slot
SW1	Power Button
SW2	Reset Switch

2.4.1 Pheonix Connector Power Input (CN2)

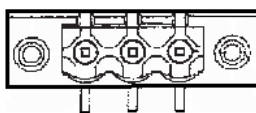

PIN1 PIN2 PIN3

Pin	Signal	Signal Type	Signal Level
1	VIN	PWR	+10V~+35V
2	GND	GND	
3	GND_EARTH		

2.4.2 SPI Flash Port (CN7)

Pin	Signal	Signal Type	Signal Level
1	SPI_MISO	OUT	
2	GND	GND	
3	SPI_CLK	IN	
4	+3.3VSB	PWR	+3.3V
5	SPI_MOSI	IN	
6	SPI_CS	IN	
7	NC		
8	NC		

2.4.3 PCIe [x4] Slot (CN8)

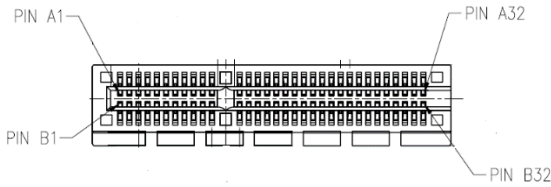

Pin	Signal	Signal Type	Signal Level
A1	PRSNT1#	I/O	
A2	+12V	PWR	+V12S
A3	+12V	PWR	+V12S
A4	GND	GND	
A5	PCIE_TXN5	DIFF	
A6	PCIE_TXP5	DIFF	
A7	PCIE_RXN5	DIFF	
A8	PCIE_RXP5	DIFF	

Pin	Signal	Signal Type	Signal Level
A9	+3.3V	PWR	+V3.3S
A10	+3.3V	PWR	+V3.3S
A11	PERST#	I/O	
A12	GND	GND	
A13	PCIE_x4SLOT_CLK	DIFF	
A14	PCIE_x4SLOT_CLK#	DIFF	
A15	GND	GND	
A16	PCIE_RXP24	DIFF	
A17	PCIE_RXN24	DIFF	
A18	GND	GND	
A19	NC		
A20	GND	GND	
A21	PCIE_RXP23	DIFF	
A22	PCIE_RXN23	DIFF	
A23	GND	GND	
A24	GND	GND	
A25	PCIE_RXP22	DIFF	
A26	PCIE_RXP22	DIFF	
A27	GND	GND	
A28	GND	GND	
A29	PCIE_RXP21	DIFF	
A30	PCIE_RXN21	DIFF	
A31	GND	GND	
A32	NC		
B1	+12V	PWR	+V12S
B2	+12V	PWR	+V12S

Pin	Signal	Signal Type	Signal Level
B3	+12V	PWR	+V12S
B4	GND	GND	
B5	SMB_CLK	I/O	
B6	SMB_DATA	I/O	
B7	GND	GND	
B8	+V3.3S	PWR	+V3.3S
B9	NC		
B10	3.3Vaux	PWR	+V3.3A
B11	WAKE#	I/O	
B12	NC		
B13	GND	GND	
B14	PCIE_TXP24	DIFF	
B15	PCIE_TXN24	DIFF	
B16	GND	GND	
B17	PRSNT	I/O	
B18	GND	GND	
B19	PCIE_TXP23	DIFF	
B20	PCIE_TXN23	DIFF	
B21	GND	GND	
B22	GND	GND	
B23	PCIE_TXP22	DIFF	
B24	PCIE_TXN22	DIFF	
B25	GND	GND	
B26	GND	GND	
B27	PCIE_TXP21	DIFF	
B28	PCIE_TXN21	DIFF	

Pin	Signal	Signal Type	Signal Level
B29	GND	GND	
B30	NC		
B31	PRSNT	I/O	
B32	GND	GND	

2.4.4 LAN (RJ-45) + Dual USB3.2 Gen 1 (CN14)

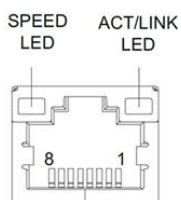

Pin	Signal	Signal Type	Signal Level
1	MDI0+	DIFF	
2	MDI0-	DIFF	
3	MDI1+	DIFF	
4	MDI2+	DIFF	
5	MDI2-	DIFF	
6	MDI1-	DIFF	
7	MDI3+	DIFF	
8	MDI3-	DIFF	

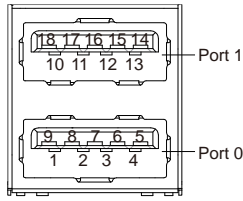

Pin	Signal	Signal Type	Signal Level
1	+5VSB	PWR	+5V
2	USB7_D-	DIFF	
3	USB7_D+	DIFF	
4	GND	GND	
5	USB7_SSRX-	DIFF	
6	USB7_SSRX+	DIFF	
7	GND	GND	
8	USB7_SSTX-	DIFF	
9	USB7_SSTX+	DIFF	
10	+5VSB	PWR	+5V
11	USB8_D-	DIFF	
12	USB8_D+	DIFF	
13	GND	GND	
14	USB8_SSRX-	DIFF	
15	USB8_SSRX+	DIFF	
16	GND	GND	
17	USB8_SSTX-	DIFF	
18	USB8_SSTX+	DIFF	

2.4.5 LAN (RJ-45) + Dual USB3.2 Gen 1 (CN15)

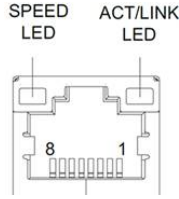

Pin	Signal	Signal Type	Signal Level
1	MDI0+	DIFF	
2	MDI0-	DIFF	
3	MDI1+	DIFF	
4	MDI2+	DIFF	
5	MDI2-	DIFF	
6	MDI1-	DIFF	
7	MDI3+	DIFF	
8	MDI3-	DIFF	

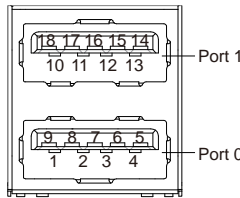

Pin	Signal	Signal Type	Signal Level
1	+5VSB	PWR	+5V
2	USB5_D-	DIFF	
3	USB5_D+	DIFF	
4	GND	GND	
5	USB5_SSRX-	DIFF	
6	USB5_SSRX+	DIFF	

Pin	Signal	Signal Type	Signal Level
7	GND	GND	
8	USB5_SSTX-	DIFF	
9	USB5_SSTX+	DIFF	
10	+5VSB	PWR	+5V
11	USB6_D-	DIFF	
12	USB6_D+	DIFF	
13	GND	GND	
14	USB6_SSRX-	DIFF	
15	USB6_SSRX+	DIFF	
16	GND	GND	
17	USB6_SSTX-	DIFF	
18	USB6_SSTX+	DIFF	

2.4.6 Audio Connector (CN18)

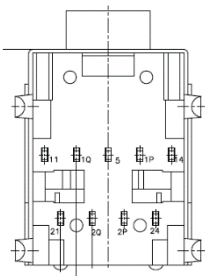

Pin	Signal	Signal Type	Signal Level
5	AUD_GND	GND	
24	LOUT_L	OUT	
21	LOUT_R	OUT	
2P	HP_DET_3	IN	

Pin	Signal	Signal Type	Signal Level
2Q	HP_DET_4	IN	
14	MIC_L	IN	
11	MIC_R	IN	
1P	HP_DET_1	IN	
1Q	HP_DET2	IN	

2.4.7 Digital IO Port (CN43)

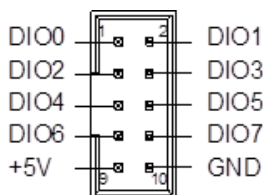

Pin	Signal	Signal Type	Signal Level
1	DIO0	I/O	+5V
2	DIO1	I/O	+5V
3	DIO2	I/O	+5V
4	DIO3	I/O	+5V
5	DIO4	I/O	+5V
6	DIO5	I/O	+5V
7	DIO6	I/O	+5V
8	DIO7	I/O	+5V
9	+5V	PWR	+5V
10	GND	GND	

2.4.8 USB2.0 Wafer BOX (5P Pitch: 1.25mm) (CN 45,71,72)

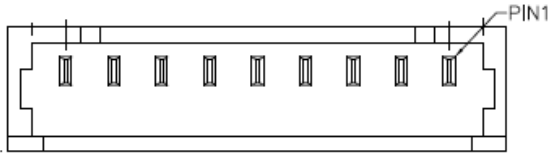

Pin	Signal	Signal Type	Signal Level
1	+5V	GND	+5V
2	USBD-	DIFF	
3	USBD+	DIFF	
4	GND	GND	
5	GND	GND	

2.4.9 COM5 + COM6 Connector RS232/RS422/RS485 (CN49)

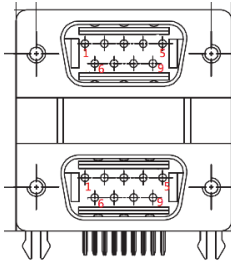

Pin	Signal	Signal Type	Signal Level
Top Port (COM5)			
1	DCD5	IN	
2	RX5	IN	
3	TX5	OUT	±9V
4	DTR5	OUT	±9V
5	GND	GND	
6	DSR5	IN	
7	RTS5	OUT	±9V

Pin	Signal	Signal Type	Signal Level
Top Port (COM5)			
8	CTS5	IN	
9	RI5	IN	
Bottom Port (COM6)			
10	DCD6	IN	
11	RX6	IN	
12	TX6	OUT	±9V
13	DTR6	OUT	±9V
14	GND	GND	
15	DSR6	IN	
16	RTS6	OUT	±9V
17	CTS6	IN	
18	RI6	IN	

2.4.10 COM1 + COM2 Connector RS232/RS422/RS485 (CN60)

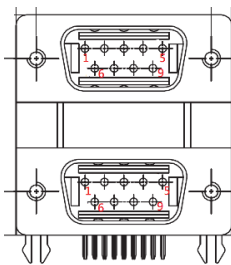

Pin	Signal	Signal Type	Signal Level
Top Port (COM 1)			
1	DCD1	IN	
2	RX1	IN	
3	TX1	OUT	±9V
4	DTR1	OUT	±9V

Pin	Signal	Signal Type	Signal Level
Top Port (COM 1)			
5	GND	GND	
6	DSR1	IN	
7	RTS1	OUT	±9V
8	CTS1	IN	
9	RI1	IN	
Bottom Port (COM2)			
10	DCD2	IN	
11	RX2	IN	
12	TX2	OUT	±9V
13	DTR2	OUT	±9V
14	GND	GND	
15	DSR2	IN	
16	RTS2	OUT	±9V
17	CTS2	IN	
18	RI2	IN	

2.4.11 COM3 + COM4 Connector RS232/RS422/RS485 (CN62)

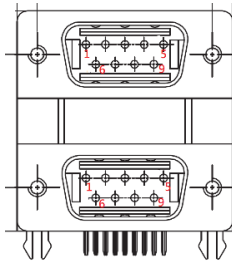

Pin	Signal	Signal Type	Signal Level
Top Port (COM3)			
1	DCD3	IN	
2	RX3	IN	
3	TX3	OUT	±9V
4	DTR3	OUT	±9V
5	GND	GND	
6	DSR3	IN	
7	RTS3	OUT	±9V
8	CTS3	IN	
9	RI3	IN	
Bottom Port (COM4)			
10	DCD4	IN	
11	RX4	IN	
12	TX4	OUT	±9V
13	DTR4	OUT	±9V
14	GND	GND	
15	DSR4	IN	
16	RTS4	OUT	±9V
17	CTS4	IN	
18	RI4	IN	

2.4.12 LAN (RJ-45) + Dual USB3.2 Gen 1 (CN73)

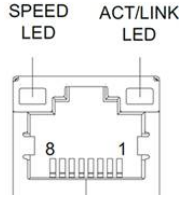

Pin	Signal	Signal Type	Signal Level
1	MDI0+	DIFF	
2	MDI0-	DIFF	
3	MDI1+	DIFF	
4	MDI2+	DIFF	
5	MDI2-	DIFF	
6	MDI1-	DIFF	
7	MDI3+	DIFF	
8	MDI3-	DIFF	

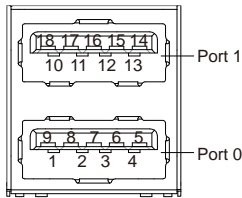

Pin	Signal	Signal Type	Signal Level
1	+5VSB	PWR	+5V
2	USB3_D-	DIFF	
3	USB3_D+	DIFF	
4	GND	GND	
5	USB3_SSRX-	DIFF	
6	USB3_SSRX+	DIFF	

Pin	Signal	Signal Type	Signal Level
7	GND	GND	
8	USB3_SSTX-	DIFF	
9	USB3_SSTX+	DIFF	
10	+5VSB	PWR	+5V
11	USB4_D-	DIFF	
12	USB4_D+	DIFF	
13	GND	GND	
14	USB4_SSRX-	DIFF	
15	USB4_SSRX+	DIFF	
16	GND	GND	
17	USB4_SSTX-	DIFF	
18	USB4_SSTX+	DIFF	

2.4.13 LAN (RJ-45) + Dual USB3.2 Gen 1 (CN74)

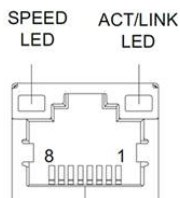

Pin	Signal	Signal Type	Signal Level
1	MDI0+	DIFF	
2	MDI0-	DIFF	
3	MDI1+	DIFF	
4	MDI2+	DIFF	
5	MDI2-	DIFF	
6	MDI1-	DIFF	

Pin	Signal	Signal Type	Signal Level
7	MDI3+	DIFF	
8	MDI3-	DIFF	

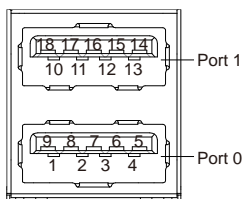

Pin	Signal	Signal Type	Signal Level
1	+5VSB	PWR	+5V
2	USB1_D-	DIFF	
3	USB1_D+	DIFF	
4	GND	GND	
5	USB1_SSRX-	DIFF	
6	USB1_SSRX+	DIFF	
7	GND	GND	
8	USB1_SSTX-	DIFF	
9	USB1_SSTX+	DIFF	
10	+5VSB	PWR	+5V
11	USB2_D-	DIFF	
12	USB2_D+	DIFF	
13	GND	GND	
14	USB2_SSRX-	DIFF	
15	USB2_SSRX+	DIFF	
16	GND	GND	
17	USB2_SSTX-	DIFF	
18	USB2_SSTX+	DIFF	

2.4.14 HDMI Port (CN75)

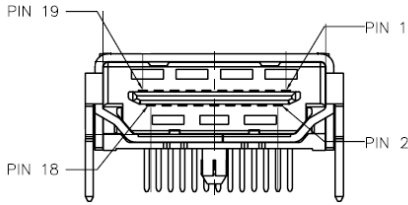

Pin	Signal	Signal Type	Signal Level
1	HDMI1_DATA2_P	OUT	
2	GND	GND	
3	HDMI1_DATA2_N	DIFF	
4	HDMI1_DATA1_P	DIFF	
5	GND	GND	
6	HDMI1_DATA1_N	DIFF	
7	HDMI1_DATA0_P	DIFF	
8	NC		
9	HDMI1_DATA0_N	DIFF	
10	HDMI1_CLK_P	DIFF	
11	GND	GND	
12	HDMI1_CLK_N	DIFF	
13	NC		
14	NC		
15	HDMI1_SCL	DIFF	
16	NC		
17	HDMI1_SDA	DIFF	
18	+V5S_HDMI_CON1	PWR	
19	HDMI1_HPD	GND	

2.4.15 HDMI Port (CN76)

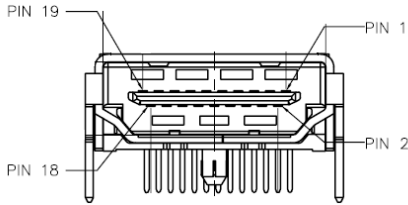

Pin	Signal	Signal Type	Signal Level
1	HDMI2_DATA2_P	DIFF	
2	GND	GND	
3	HDMI2_DATA2_N	DIFF	
4	HDMI2_DATA1_P	DIFF	
5	GND	GND	
6	HDMI2_DATA1_N	DIFF	
7	HDMI2_DATA0_P	DIFF	
8	NC		
9	HDMI2_DATA0_N	DIFF	
10	HDMI2_CLK_P	DIFF	
11	GND	GND	
12	HDMI2_CLK_N	DIFF	
13	NC		
14	NC		
15	HDMI2_SCL	DIFF	
16	HDMI2_SDA	DIFF	
17	GND	GND	
18	+V5S_HDMI_CON2	PWR	
19	HDMI2_HPD	GND	

2.4.16 LPC Port (LPC1)

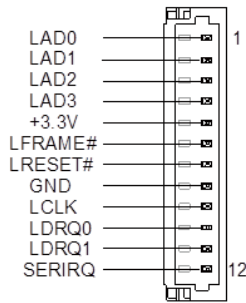

Pin	Signal	Signal Type	Signal Level
1	LAD0	I/O	+3.3V
2	LAD1	I/O	+3.3V
3	LAD2	I/O	+3.3V
4	LAD3	I/O	+3.3V
5	+3.3V	PWR	+3.3V
6	LFRAME#	IN	
7	LRESET#	OUT	+3.3V
8	GND	GND	
9	LCLK	OUT	
10	LDRQ0	IN	
11	LDRQ1	IN	
12	SERIRQ	I/O	+3.3V

2.4.17 Mini Card Slot (Full-Sized) (PCIe1)

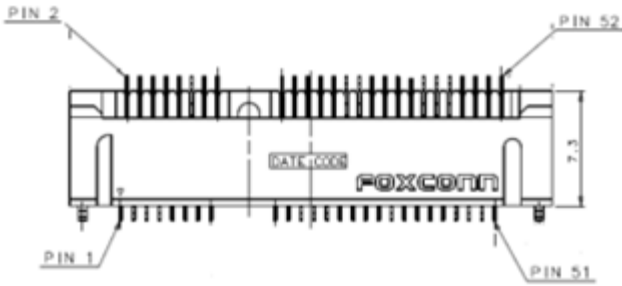

Pin	Signal	Signal Type	Signal Level
1	PCIE_WAKE#	IN	
2	+3.3V	PWR	+3.3V
3	NC		
4	GND	GND	
5	NC		
6	+1.5V	PWR	+1.5V
7	PCIE_CLK_REQ#	IN	
8	NC	PWR	
9	GND	GND	
10	NC	I/O	
11	PCIE_REF_CLK-	DIFF	
12	NC	IN	
13	PCIE_REF_CLK+	DIFF	
14	NC	IN	
15	GND	GND	
16	NC	PWR	
17	NC		

Pin	Signal	Signal Type	Signal Level
18	GND	GND	
19	NC		
20	W_DISABLE#	OUT	+3.3V
21	GND	GND	
22	PCIE_RST#	OUT	+3.3V
23	PCIE_RX-	DIFF	
24	+3.3VSB	PWR	+3.3V
25	PCIE_RX+	DIFF	
26	GND	GND	
27	GND	GND	
28	+1.5V	PWR	+1.5V
29	GND	GND	
30	SMB_CLK	I/O	+3.3V
31	PCIE_TX-	DIFF	
32	SMB_DATA	I/O	+3.3V
33	PCIE_TX+	DIFF	
34	GND	GND	
35	GND	GND	
36	USB_D-	DIFF	
37	GND	GND	
38	USB_D+	DIFF	
39	+3.3VSB	PWR	+3.3V
40	GND	GND	
41	+3.3VSB	PWR	+3.3V
42	NC		
43	GND	GND	

Pin	Signal	Signal Type	Signal Level
44	NC		
45	NC		
46	NC		
47	NC		
48	+1.5V	PWR	+1.5V
49	NC		
50	GND	GND	
51	NC		
52	+3.3VSB	PWR	+3.3V

2.4.18 Mini Card Slot with mSATA (Full Sized) (PCIe2)

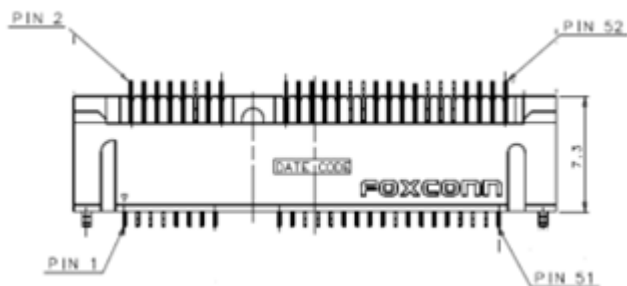

Pin	Signal	Signal Type	Signal Level
1	PCIE_WAKE#	IN	
2	+3.3V	PWR	+3.3V
3	NC		
4	GND	GND	
5	NC		
6	+1.5V	PWR	+1.5V
7	PCIE_CLK_REQ#	IN	

Pin	Signal	Signal Type	Signal Level
8	NC	PWR	
9	GND	GND	
10	NC	I/O	
11	PCIE_REF_CLK-	DIFF	
12	NC	IN	
13	PCIE_REF_CLK+	DIFF	
14	NC	IN	
15	GND	GND	
16	NC	PWR	
17	NC		
18	GND	GND	
19	NC		
20	W_DISABLE#	OUT	+3.3V
21	GND	GND	
22	PCIE_RST#	OUT	+3.3V
23	PCIE_RX-	DIFF	
24	+3.3VSB	PWR	+3.3V
25	PCIE_RX+	DIFF	
26	GND	GND	
27	GND	GND	
28	+1.5V	PWR	+1.5V
29	GND	GND	
30	SMB_CLK	I/O	+3.3V
31	PCIE_TX-	DIFF	
32	SMB_DATA	I/O	+3.3V
33	PCIE_TX+	DIFF	

Pin	Signal	Signal Type	Signal Level
34	GND	GND	
35	GND	GND	
36	USB_D-	DIFF	
37	GND	GND	
38	USB_D+	DIFF	
39	+3.3VSB	PWR	+3.3V
40	GND	GND	
41	+3.3VSB	PWR	+3.3V
42	NC		
43	GND	GND	
44	NC		
45	NC		
46	NC		
47	NC		
48	+1.5V	PWR	+1.5V
49	NC		
50	GND	GND	
51	NC		
52	+3.3VSB	PWR	+3.3V

2.4.19 SATA PWR (PWR 1,2)

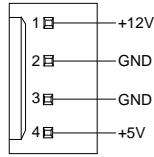

Pin	Signal	Signal Type	Signal Level
1	+12V	PWR	+12V
2	GND	GND	
3	GND	GND	
4	+5V	PWR	+5V

2.4.20 SATA Port (SATA 3,4)

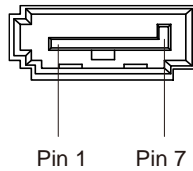

Pin	Signal	Signal Type	Signal Level
1	GND	GND	
2	SATA_TX+	DIFF	
3	SATA_TX-	DIFF	
4	GND	GND	
5	SATA_RX-	DIFF	
6	SATA_RX+	DIFF	
7	GND	GND	

2.4.21 SIM Slot (SIM1)

Pin	Signal	Signal Type	Signal Level
1	UIM_PWR	PWR	
2	UIM_RST	IN	
3	UIM_CLK	IN	
4	GND	GND	
5	UIM_VPP	PWR	
6	UIM_DATA	I/O	

2.5 CPU Installation

Before installing the CPU, ensure the system is powered down and disconnect the power cord from the system. Make sure you have the processor ready to install. See Chapter 1 Specifications for list of compatible CPU/processors.

Step 1: Remove the screws on the front and back of the BOXER-6839-CFL as shown in the figure below (six in total), and remove the top heatsink.

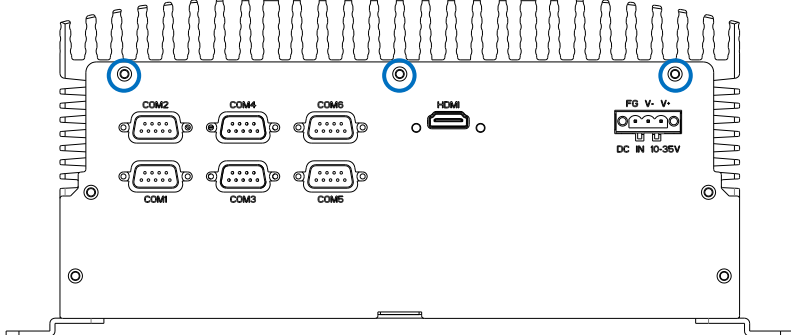
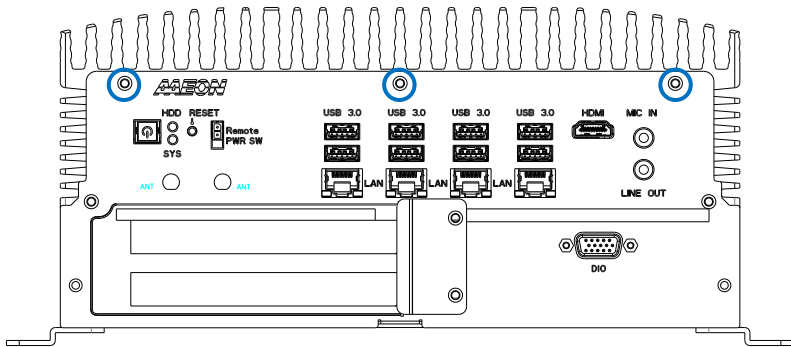

Step 2: Install the CPU into the socket and place the thermal pad on top of the processor.

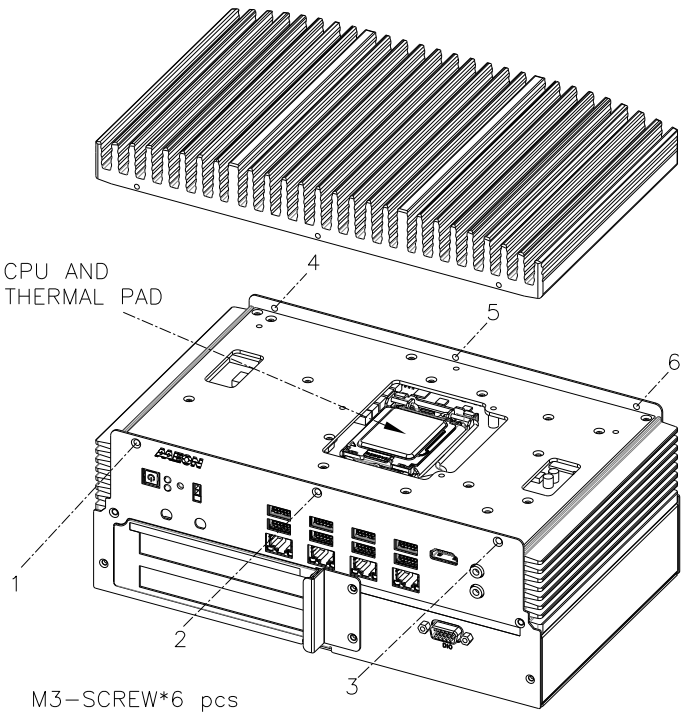

Step 3: Place the heatsink back on and secure with the screws you removed in Step 1.

2.6 Expansion Card Installation

Before installing expansion cards, ensure the system is powered down and disconnect the power cord from the system. Make sure you have the expansion card ready to install. See Chapter 1 for expansion card requirements and specifications.

Step 1: Remove the eight (8) screws from the bottom of the BOXER-6839-CFL. Remove the bottom panel from the system. Also remove the expansion card bracket by removing the two (2) screws holding it in place.

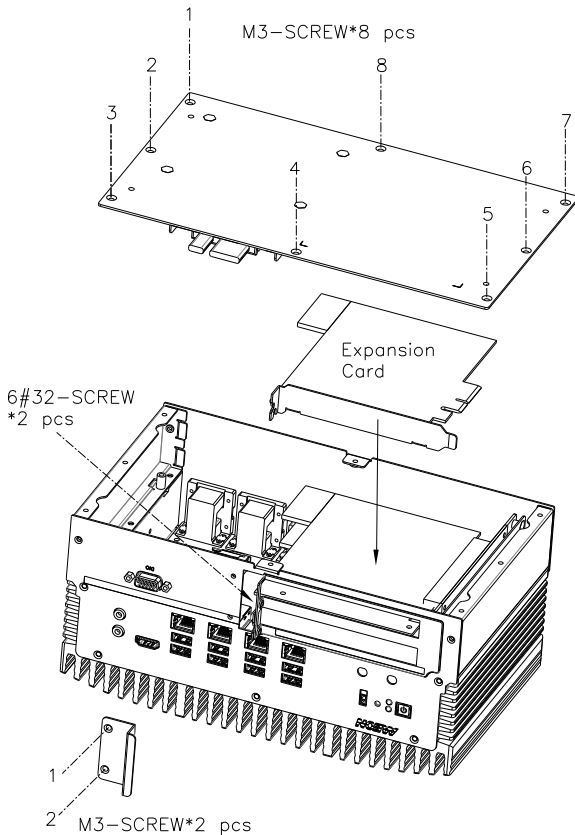

Step 2: Remove the expansion bay cover and install the expansion card. Secure to the chassis with a screw.

Step 3: Reattach the expansion card bracket and secure with the two screws removed in Step 1. Then, replace and secure the bottom panel with the eight screws removed in Step 1. You can skip this step if you also need to install the 2.5" SATA drives.

2.7 2.5" SATA Drive Installation

Before installing the 2.5" SATA drive(s), ensure the system is powered down and disconnect the power cord from the system. Make sure you have the 2.5" SATA drive(s) ready to install. See Chapter 1 for 2.5" SATA drive requirements and specifications.

Step 1: Remove the eight (8) screws from the bottom of the BOXER-6839-CFL. Remove the bottom panel from the system.

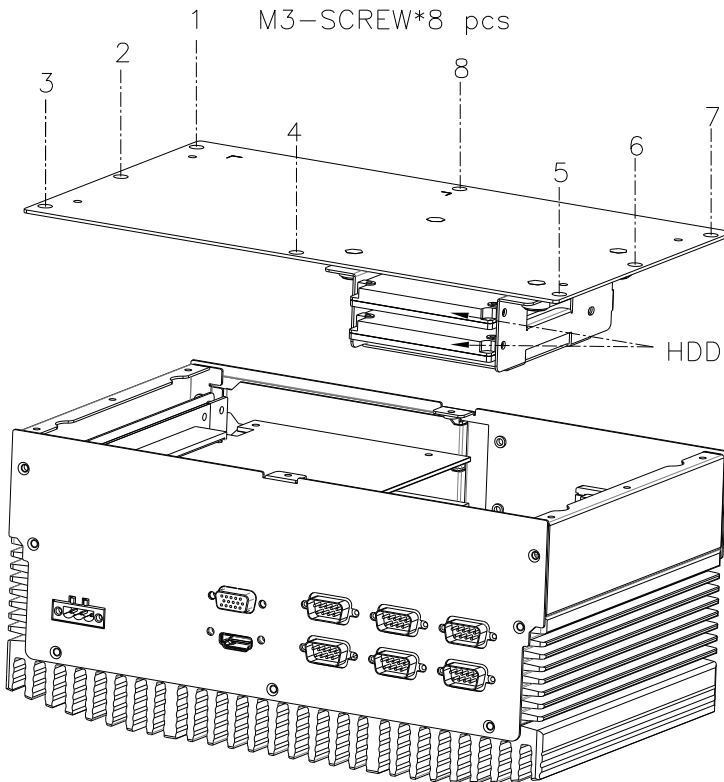

Step 2: Install the 2.5" SATA drives into the SATA drive mount shown. Secure with four side screws.

Step 3: Attach the SATA and SATA Power cables to the board and the SATA drive.

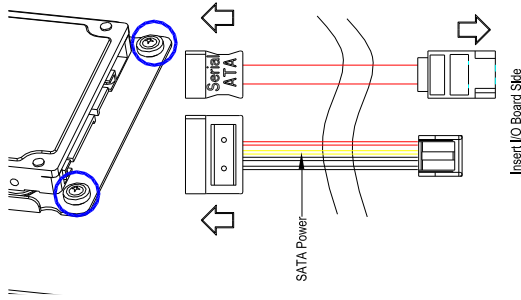

Step 4: Replace the bottom panel and secure with the eight (8) screws you removed in Step 1.

2.8 Wallmount Assembly

Step 1: Line up the wallmount brackets in the mounting kit with the holes as shown. The middle hole should line up with the bottom panel screw such that you can easily remove the screw from the bottom panel without having to remove the bracket

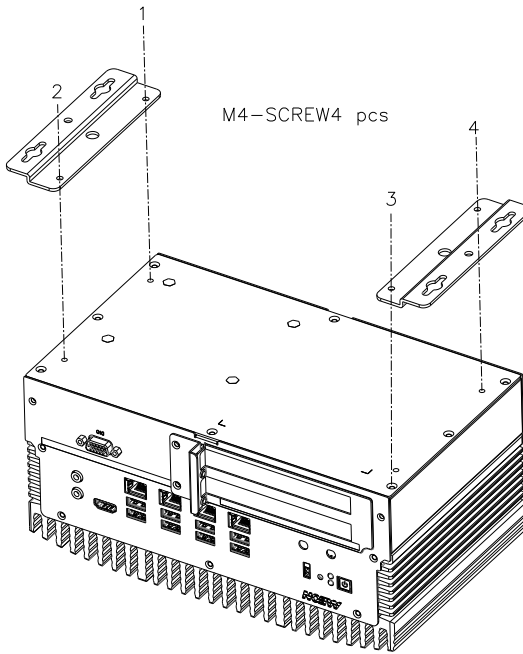

Step 2: Use the four screws included with the wallmount kit to secure the wall mount brackets.

Chapter 3

AMI BIOS Setup

3.1 System Test and Initialization

The system uses certain routines to perform testing and initialization during the boot up sequence. If an error, fatal or non-fatal, is encountered, the system will output a few short beeps or an error message. The board can usually continue the boot up sequence with non-fatal errors.

The system configuration verification routines check the current system configuration against the values stored in the CMOS memory. If they do not match, an error message will be output, and the BIOS setup program will need to be run to set the configuration information in memory.

There are three situations in which the CMOS settings will need to be set or changed:

- Starting the system for the first time
- The system hardware has been changed
- The CMOS memory has lost power and the configuration information is erased

The system's CMOS memory uses a backup battery for data retention. The battery must be replaced when it runs down.

3.2 AMI BIOS Setup

The AMI BIOS ROM has a pre-installed Setup program that allows users to modify basic system configurations, which is stored in the battery-backed CMOS RAM and BIOS NVRAM so that the information is retained when the power is turned off.

To enter BIOS Setup, press or <F2> immediately while your computer is powering up.

The function for each interface can be found below.

Main – Date and time can be set here. Press <Tab> to switch between date elements

Advanced – Enable/ Disable boot option for legacy network devices

Chipset – For hosting bridge parameters

Security – The setup administrator password can be set here

Boot – Enable/ Disable Quiet Boot option

Save & Exit – Save your changes and exit the program

3.3 Setup Submenu: Main

Aptio Setup Utility - Copyright (C) 2021 American Megatrends, Inc.

Main Advanced Chipset Security Boot Save & Exit

BIOS Information BOXER-6839-CFL R1.0 (B839BM10) (03/12/2021)	Set the Date. Use Tab to switch between Date elements. Default Ranges: Year: 2005-2099 Months: 1-12 Days: dependent on month
BIOS Vendor Compliance	American Megatrends UEFI 2.7; PI 1.6
System Date System Time	[Sun 03/14/2021] [18:53:38]
Access Level	Administrator

++: Select Screen
T1: Select Item
Enter: Select
+/-: Change Opt.
F1: General Help
F2: Previous Values
F3: Optimized Defaults
F4: Save & Exit
ESC: Exit

Version 2.20.1275. Copyright (C) 2021 American Megatrends, Inc.

3.4 Setup Submenu: Advanced

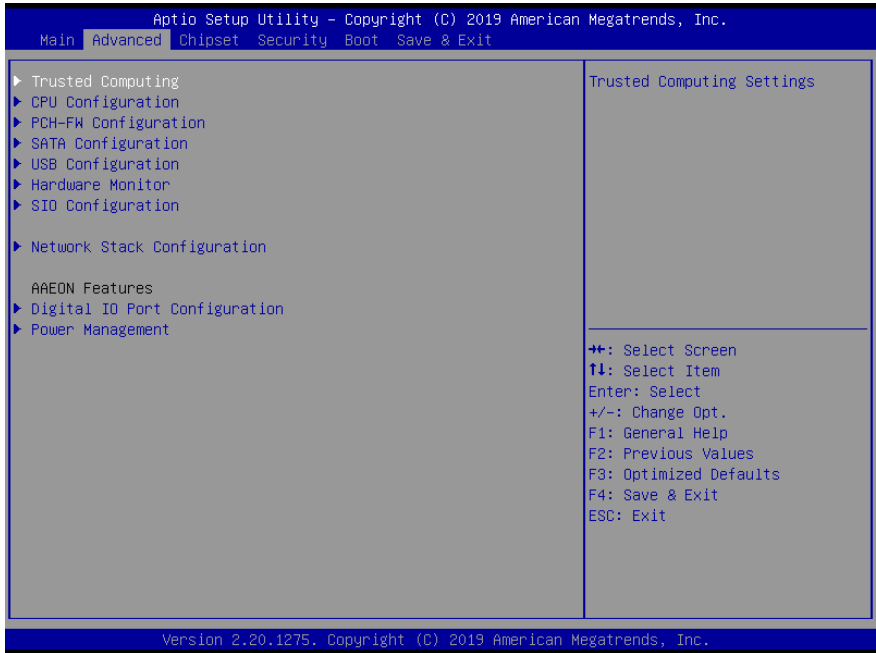

3.4.1 Advanced: Trusted Computing

Aptio Setup Utility - Copyright (C) 2019 American Megatrends, Inc.

Advanced

<pre> TPM20 Device Found Firmware Version: 403.1 Vendor: INTC Security Device Support [Enabled] Active PCR banks SHA-1,SHA256 Available PCR banks SHA-1,SHA256 SHA-1 PCR Bank [Enabled] SHA256 PCR Bank [Enabled] Pending operation [None] Platform Hierarchy [Enabled] Storage Hierarchy [Enabled] Endorsement Hierarchy [Enabled] TPM2.0 UEFI Spec Version [TCG_2] Physical Presence Spec Version [1.3] TPM 20 InterfaceType [CRB] Device Select [Auto] </pre>	<p>Enables or Disables BIOS support for security device. O.S. will not show Security Device. TCG EFI protocol and INT1A interface will not be available.</p> <hr/> <p> ++: Select Screen T1: Select Item Enter: Select +/-: Change Opt. F1: General Help F2: Previous Values F3: Optimized Defaults F4: Save & Exit ESC: Exit </p>
---------------------------------------------------------------------------------------------------------------------------------------------------------------------------------------------------------------------------------------------------------------------------------------------------------------------------------------------------------------------------------------------------------------------------------------------------------------------------------------------------------------------------------------------------------	----------------------------------------------------------------------------------------------------------------------------------------------------------------------------------------------------------------------------------------------------------------------------------------------------------------------------------------------------------------------------------------------------------------------------------------------------------------------------------------------------------------------------------------------------------

Version 2.20.1275. Copyright (C) 2019 American Megatrends, Inc.

Options Summary						
Security Device Support	<table border="1" style="width: 100%; border-collapse: collapse;"> <tr><td style="width: 50%;">Enable</td><td style="width: 50%;">Optimal Default, Failsafe Default</td></tr> <tr><td>Disable</td><td></td></tr> </table>	Enable	Optimal Default, Failsafe Default	Disable		
Enable	Optimal Default, Failsafe Default					
Disable						
Enable or Disable BIOS support for security device. TCG EFI protocol and INT1A interface will not be available.						
SHA-1 PCR Bank	<table border="1" style="width: 100%; border-collapse: collapse;"> <tr><td style="width: 50%;">Enabled</td><td style="width: 50%;">Optimal Default, Failsafe Default</td></tr> <tr><td>Disabled</td><td></td></tr> </table>	Enabled	Optimal Default, Failsafe Default	Disabled		
Enabled	Optimal Default, Failsafe Default					
Disabled						
Enable or Disable SHA-1 PCR Bank						
SHA256 PCR Bank	<table border="1" style="width: 100%; border-collapse: collapse;"> <tr><td style="width: 50%;">Enabled</td><td style="width: 50%;">Optimal Default, Failsafe Default</td></tr> <tr><td>Disabled</td><td></td></tr> </table>	Enabled	Optimal Default, Failsafe Default	Disabled		
Enabled	Optimal Default, Failsafe Default					
Disabled						
Enable or Disable SHA256 PCR Bank						
Pending operation	<table border="1" style="width: 100%; border-collapse: collapse;"> <tr><td style="width: 50%;">None</td><td style="width: 50%;">Optimal Default, Failsafe Default</td></tr> <tr><td>TPM Clear</td><td></td></tr> </table>	None	Optimal Default, Failsafe Default	TPM Clear		
None	Optimal Default, Failsafe Default					
TPM Clear						
Schedule an Operation for the Security Device. NOTE: Your Computer will reboot during restart in order to change State of Security Device.						

Table Continues on Next Page

Options Summary		
Platform Hierarchy	Enabled	Optimal Default, Failsafe Default
	Disabled	
Enable or Disable Platform Hierarchy		
Storage Hierarchy	Enabled	Optimal Default, Failsafe Default
	Disabled	
Enable or Disable Storage Hierarchy		
Endorsement Hierarchy	Enabled	Optimal Default, Failsafe Default
	Disabled	
Enable or Disable Endorsement Hierarchy		
TPM2.0 UEFI Spec Version	TCG_2	Optimal Default, Failsafe Default
	TCG_1_2	
Select the TCG2 Spec Version Support TCG_1_2: Compatible mode for Win8/Win10 TCG_2: Support new TCG2 protocol and event format for Win10 or later		
Physical Presence Spec Version	1.3	Optimal Default, Failsafe Default
	1.2	
Select to Tell O.S. to support PPI Spec Version 1.2 or 1.3. Note some HCK tests might not support 1.3.		
Device Select	Auto	Optimal Default, Failsafe Default
	TPM 1.2	
	TPM 2.0	
TPM 1.2 will restrict support to TPM 1.2 devices, TPM 2.0 will restrict support to TPM 2.0 devices, Auto will support both with the default set to TPM 2.0 devices if not found, TPM 1.2 devices will be enumerated		

3.4.2 Advanced: CPU Configuration

Aptio Setup Utility - Copyright (C) 2021 American Megatrends, Inc.

Advanced

CPU Configuration		When enabled, a VMM can utilize the additional hardware capabilities provided by Vanderpool Technology.
Name	CoffeeLake DT	
Type	Intel(R) Core(TM) i7-8700T CPU @ 2.40GHz	
Speed	2400 MHz	
ID	0x906EA	
Stepping	U0	
Package	LGA1151	
Number of Processors	6Core(s) / 12Thread(s)	
Microcode Revision	DE	
GT Info	GT2 (0x3E92)	
eDRAM Size	N/A	
VMX	Supported	++: Select Screen T1: Select Item Enter: Select +/-: Change Opt. F1: General Help F2: Previous Values F3: Optimized Defaults F4: Save & Exit ESC: Exit
SMX/TXT	Supported	
Intel (VMX) Virtualization Technology	[Enabled]	
Active Processor Cores	[All]	
Intel(R) SpeedStep(tm)	[Enabled]	
Intel(R) Speed Shift Technology	[Disabled]	
Turbo Mode	[Enabled]	
C states	[Disabled]	
Hyper-Threading	[Enabled]	

Version 2.20.1275. Copyright (C) 2021 American Megatrends, Inc.

Options Summary

Intel (VMX) Virtualization Technology	Disabled	Optimal Default, Failsafe Default
	Enabled	
When enabled, a VMM can utilize the additional hardware capabilities provided by Vanderpool Technology.		
Active Processor Cores	1	Optimal Default, Failsafe Default
	2	
	3	
	All	
Number of cores to enable in each processor package.		
Intel(R) SpeedStep(tm)	Disabled	Optimal Default, Failsafe Default
	Enabled	
Allows more than two frequency ranges to be supported.		
Intel(R) Speed Shift Technology	Disabled	Optimal Default, Failsafe Default
	Enabled	
Enable/Disable Intel(R) Speed Shift Technology support. Enabling will expose the CPPC v2 interface to allow for hardware controlled P-states.		

Options Summary		
Turbo Mode	Disabled	Optimal Default, Failsafe Default
	Enabled	
Enable/Disable Processor Turbo Mode (requires Intel Speed Step or Intel Speed Shift to be available or enabled).		
C states	Disabled	Optimal Default, Failsafe Default
	Enabled	
Enable/Disable CPU Power Management. Allows CPU to go C states when it's not 100% utilized		
Hyper-Threading	Disabled	Optimal Default, Failsafe Default
	Enabled	
Enabled or Disabled Hyper-Threading Technology.		

3.4.3 Advanced: PCH-FW Configuration

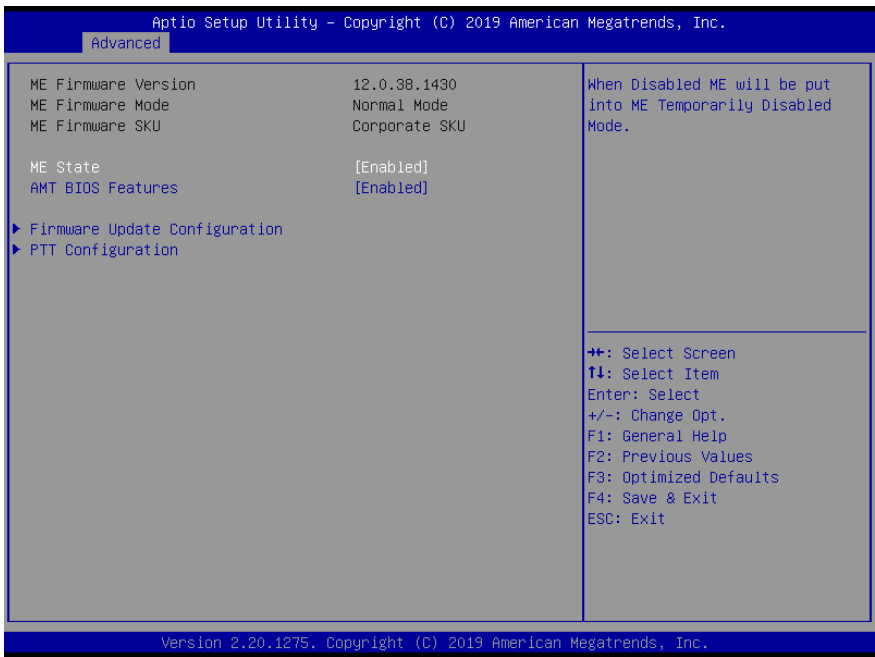

Options Summary

ME State	Enabled	Optimal Default, Failsafe Default
	Disabled	
When Disabled ME will be put into ME Temporarily Disabled Mode.		
AMT BIOS Feature	Enabled	Optimal Default, Failsafe Default
	Disabled	
When disabled AMT BIOS Features are no longer supported and user is no longer able to access MEBx Setup.		
Note: This option does not disable Manageability Features in FW.		

3.4.3.1 Firmware Update Configuration

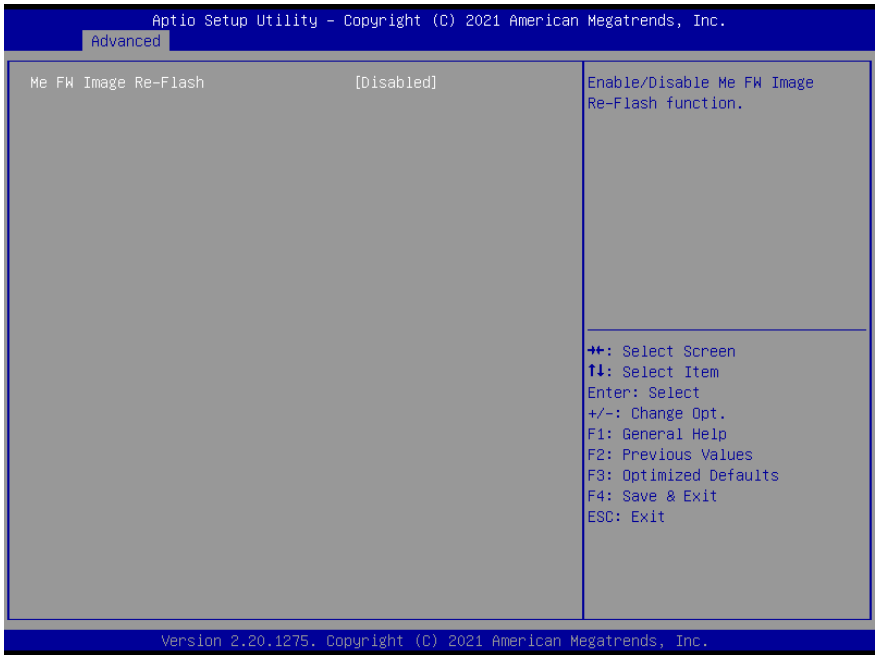

Options Summary

ME FW Image Re-Flash	Enabled	Optimal Default, Failsafe Default
	Disabled	
Enable/Disable ME FW Image Re-Flash function.		

3.4.3.2 PTT Configuration

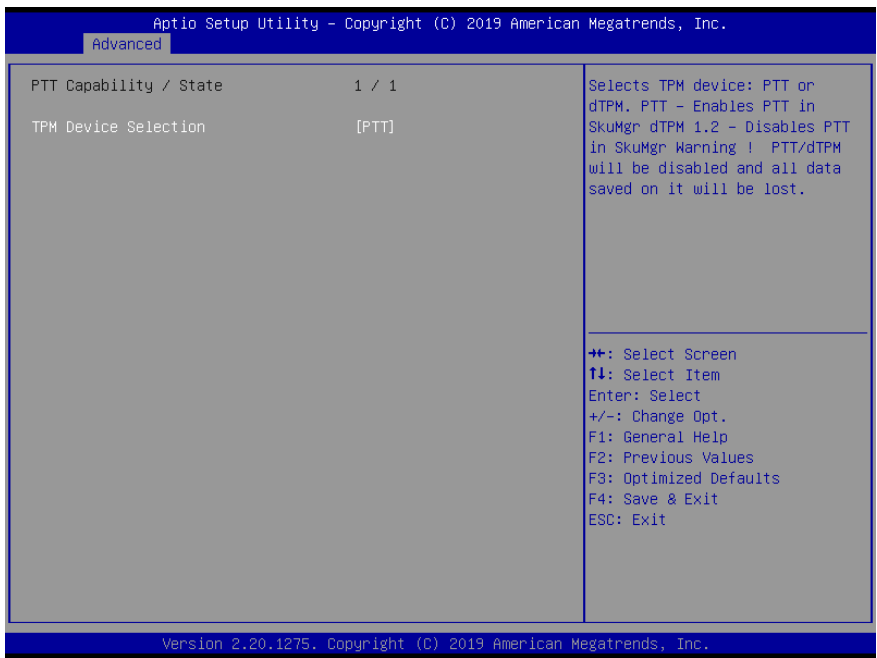

Options Summary

ME FW Image Re-Flash	dTPM	
	PTT	Optimal Default, Failsafe Default

Selects TPM device: PTT or dTPM.
 PTT – Enables PTT in SkuMgr
 dTPM 1.2 – Disables PTT in SkuMgr
Warning! PTT/dTPM will be disabled and all saved data will be lost.

3.4.4 Advanced: SATA Configuration

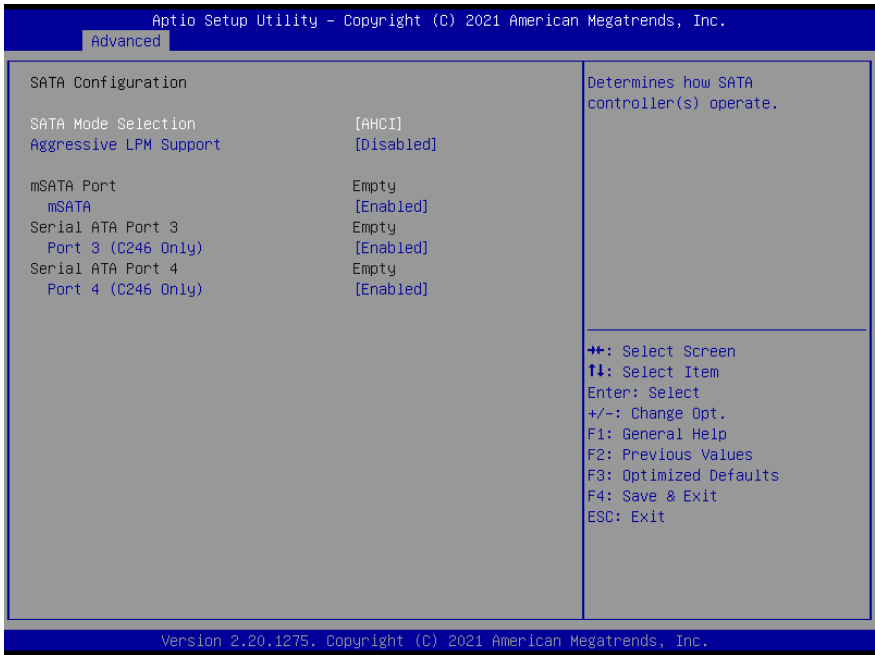

Options Summary		
SATA Mode Selection	AHCI Mode	Optimal Default, Failsafe Default
	Intel RST Premium With Intel Optane System Acceleration	
Determines how SATA controller(s) operate.		
Aggressive LPM Support	Enabled	Optimal Default, Failsafe Default
	Disabled	
Enable PCH to aggressively enter link power state.		
mSATA	Enabled	Optimal Default, Failsafe Default
	Disabled	
Enable or Disable SATA Port.		
Port 3/4	Enabled	Optimal Default, Failsafe Default
	Disabled	
Enable or Disable SATA Port.		

3.4.5 Advanced: USB Configuration

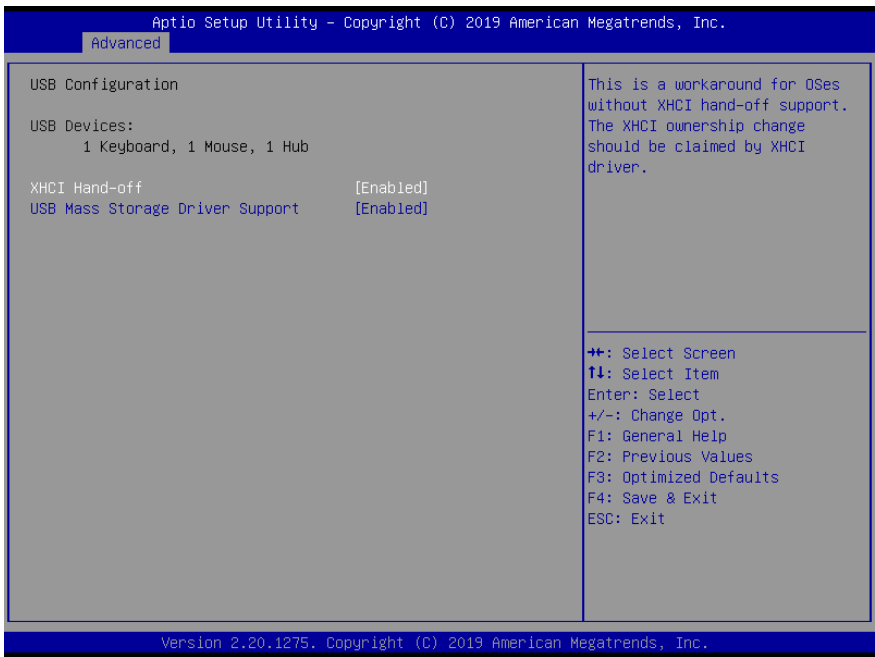

Options Summary		
XHCI Hand-off	Enabled	Optimal Default, Failsafe Default
	Disabled	
This is a workaround for OSes without XHCI Hand-off support. The XHCI ownership change should be claimed by XHCI driver.		
USB Mass Storage Driver Support	Enabled	Optimal Default, Failsafe Default
	Disabled	
Enable/Disable USB Mass Storage Driver Support.		

3.4.6 Advanced: Hardware Monitor

Aptio Setup Utility - Copyright (C) 2019 American Megatrends, Inc.

Advanced

Pc Health Status

CPU Temperature(DTS)	: +56 %
System temperature	: +51 %
VCC_CORE	: +0.840 V
VDDQ_MEM	: +1.208 V
V5S	: +5.045 V
V12S	: +11.968 V
VCC3V	: +3.328 V
VSB3V	: +3.360 V
VSB5V	: +5.064 V
VBAT	: +3.152 V

++: Select Screen
T1: Select Item
Enter: Select
+/-: Change Opt.
F1: General Help
F2: Previous Values
F3: Optimized Defaults
F4: Save & Exit
ESC: Exit

Version 2.20.1275. Copyright (C) 2019 American Megatrends, Inc.

3.4.7 Advanced: SIO Configuration

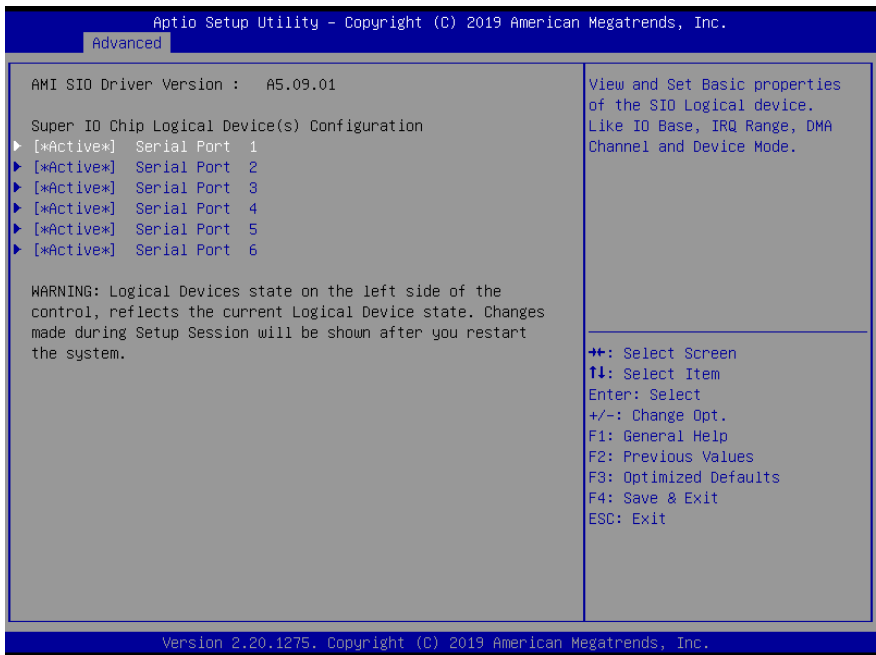

3.4.7.1 Serial Port 1 Configuration

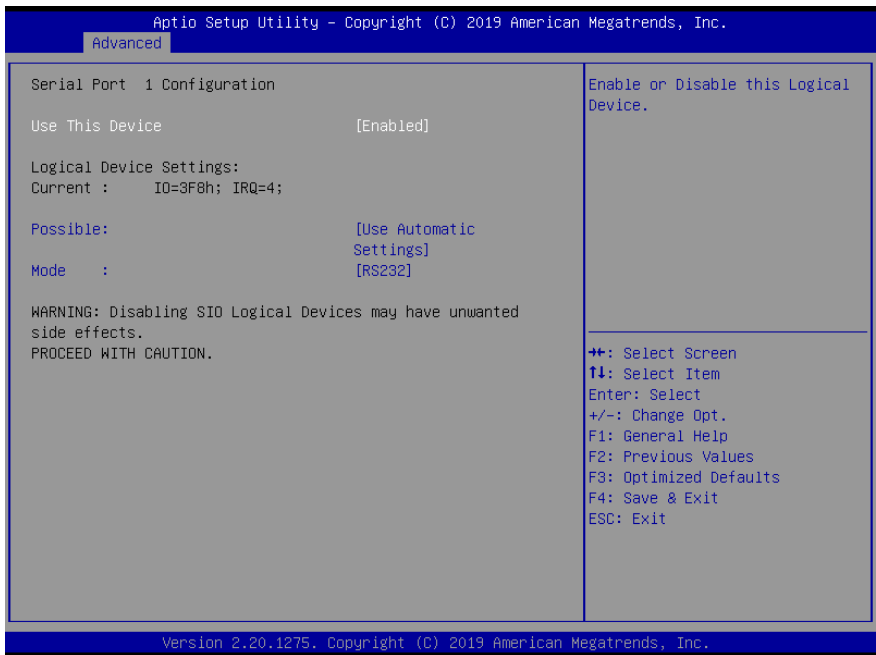

Options Summary		
Use This Device	Enabled	Optimal Default, Failsafe Default
	Disabled	
Enabled or Disabled this Logical Device.		
Device resource settings	USB Automatic Setting	Optimal Default, Failsafe Default
	IO=3F8h; IRQ = 4;	
	IO=2F8h; IRQ = 3;	
Allows the user to change the device resource settings. New settings will be reflected on this setup page after system restarts.		
UART selection	RS232	Optimal Default, Failsafe Default
	RS422	
	RS485	
UART RS232, 422, 485 selection.		

3.4.7.2 Serial Port 2 Configuration

Aptio Setup Utility - Copyright (C) 2019 American Megatrends, Inc.

Advanced

<p>Serial Port 2 Configuration</p> <p>Use This Device [Enabled]</p> <p>Logical Device Settings: Current : IO=2F8h; IRQ=3;</p> <p>Possible: [Use Automatic Settings]</p> <p>Mode : [RS232]</p> <p>WARNING: Disabling SIO Logical Devices may have unwanted side effects. PROCEED WITH CAUTION.</p>	<p>Allows the user to change the device resource settings. New settings will be reflected on this setup page after system restarts.</p> <hr/> <p> ++: Select Screen T1: Select Item Enter: Select +/-: Change Opt. F1: General Help F2: Previous Values F3: Optimized Defaults F4: Save & Exit ESC: Exit </p>
--------------------------------------------------------------------------------------------------------------------------------------------------------------------------------------------------------------------------------------------------------------------------------------------------------------------------------------------------------------------------------------------------------------------	---------------------------------------------------------------------------------------------------------------------------------------------------------------------------------------------------------------------------------------------------------------------------------------------------------------------------------------------------------------------------------------------------------------------------------------------------------------------------------------------------------------------------------------------------------------

Version 2.20.1275. Copyright (C) 2019 American Megatrends, Inc.

Options Summary		
Use This Device	Enabled	Optimal Default, Failsafe Default
	Disabled	
Enabled or Disabled this Logical Device.		
Device resource settings	USB Automatic Setting	Optimal Default, Failsafe Default
	IO=2F8h; IRQ = 3;	
	IO=3F8h; IRQ = 4;	
Allows the user to change the device resource settings. New settings will be reflected on this setup page after system restarts.		
UART selection	RS232	Optimal Default, Failsafe Default
	RS422	
	RS485	
UART RS232, 422, 485 selection.		

3.4.7.3 Serial Port 3 Configuration

Aptio Setup Utility - Copyright (C) 2019 American Megatrends, Inc.

Advanced

<p>Serial Port 3 Configuration</p> <p>Use This Device [Enabled]</p> <p>Logical Device Settings: Current : IO=3E8h; IRQ=11;</p> <p>Possible: [Use Automatic Settings]</p> <p>Mode : [RS232]</p> <p>WARNING: Disabling SIO Logical Devices may have unwanted side effects. PROCEED WITH CAUTION.</p>	<p>Allows the user to change the device resource settings. New settings will be reflected on this setup page after system restarts.</p> <hr/> <p> ++: Select Screen T1: Select Item Enter: Select +/-: Change Opt. F1: General Help F2: Previous Values F3: Optimized Defaults F4: Save & Exit ESC: Exit </p>
---------------------------------------------------------------------------------------------------------------------------------------------------------------------------------------------------------------------------------------------------------------------------------------------------------------------------------------------------------------------------------------------------------------------	---------------------------------------------------------------------------------------------------------------------------------------------------------------------------------------------------------------------------------------------------------------------------------------------------------------------------------------------------------------------------------------------------------------------------------------------------------------------------------------------------------------------------------------------------------------

Version 2.20.1275. Copyright (C) 2019 American Megatrends, Inc.

Options Summary								
Use This Device	<table border="1" style="width: 100%; border-collapse: collapse;"> <tr><td style="width: 50%;">Enabled</td><td style="width: 50%;"></td></tr> <tr><td>Disabled</td><td></td></tr> </table>	Enabled		Disabled		Optimal Default, Failsafe Default		
Enabled								
Disabled								
Enabled or Disabled this Logical Device.								
Device resource settings	<table border="1" style="width: 100%; border-collapse: collapse;"> <tr><td style="width: 50%;">USB Automatic Setting</td><td style="width: 50%;"></td></tr> <tr><td>IO=3E8h; IRQ = 11;</td><td></td></tr> <tr><td>IO=2E8h; IRQ = 11;</td><td></td></tr> </table>	USB Automatic Setting		IO=3E8h; IRQ = 11;		IO=2E8h; IRQ = 11;		Optimal Default, Failsafe Default
USB Automatic Setting								
IO=3E8h; IRQ = 11;								
IO=2E8h; IRQ = 11;								
Allows the user to change the device resource settings. New settings will be reflected on this setup page after system restarts.								
UART selection	<table border="1" style="width: 100%; border-collapse: collapse;"> <tr><td style="width: 50%;">RS232</td><td style="width: 50%;"></td></tr> <tr><td>RS422</td><td></td></tr> <tr><td>RS485</td><td></td></tr> </table>	RS232		RS422		RS485		Optimal Default, Failsafe Default
RS232								
RS422								
RS485								
UART RS232, 422, 485 selection.								

3.4.7.4 Serial Port 4 Configuration

Aptio Setup Utility - Copyright (C) 2019 American Megatrends, Inc.

Advanced

<p>Serial Port 4 Configuration</p> <p>Use This Device [Enabled]</p> <p>Logical Device Settings: Current : IO=2E8h; IRQ=11;</p> <p>Possible: [Use Automatic Settings]</p> <p>Mode : [RS232]</p> <p>WARNING: Disabling SIO Logical Devices may have unwanted side effects. PROCEED WITH CAUTION.</p>	<p>Enable or Disable this Logical Device.</p> <p> ++: Select Screen T1: Select Item Enter: Select +/-: Change Opt. F1: General Help F2: Previous Values F3: Optimized Defaults F4: Save & Exit ESC: Exit </p>
------------------------------------------------------------------------------------------------------------------------------------------------------------------------------------------------------------------------------------------------------------------------------------------------------------	----------------------------------------------------------------------------------------------------------------------------------------------------------------------------------------------------------------------------------------------------------------------------------------------------------------------------------------------------------------------------------------------------------------------------------------------------------------------------------------------------------

Version 2.20.1275. Copyright (C) 2019 American Megatrends, Inc.

Options Summary					
Use This Device	<table border="1" style="width: 100%; border-collapse: collapse;"> <tr><td style="padding: 2px;">Enabled</td></tr> <tr><td style="padding: 2px;">Disabled</td></tr> </table>	Enabled	Disabled	Optimal Default, Failsafe Default	
Enabled					
Disabled					
Enabled or Disabled this Logical Device.					
Device resource settings	<table border="1" style="width: 100%; border-collapse: collapse;"> <tr><td style="padding: 2px;">USB Automatic Setting</td></tr> <tr><td style="padding: 2px;">IO=2E8h; IRQ = 11;</td></tr> <tr><td style="padding: 2px;">IO=3E8h; IRQ = 11;</td></tr> </table>	USB Automatic Setting	IO=2E8h; IRQ = 11;	IO=3E8h; IRQ = 11;	Optimal Default, Failsafe Default
USB Automatic Setting					
IO=2E8h; IRQ = 11;					
IO=3E8h; IRQ = 11;					
Allows the user to change the device resource settings. New settings will be reflected on this setup page after system restarts.					
UART selection	<table border="1" style="width: 100%; border-collapse: collapse;"> <tr><td style="padding: 2px;">RS232</td></tr> <tr><td style="padding: 2px;">RS422</td></tr> <tr><td style="padding: 2px;">RS485</td></tr> </table>	RS232	RS422	RS485	Optimal Default, Failsafe Default
RS232					
RS422					
RS485					
UART RS232, 422, 485 selection.					

3.4.7.5 Serial Port 5 Configuration

Aptio Setup Utility - Copyright (C) 2019 American Megatrends, Inc.

Advanced

<p>Serial Port 5 Configuration</p> <p>Use This Device [Enabled]</p> <p>Logical Device Settings: Current : IO=2D0h; IRQ=11;</p> <p>Possible: [Use Automatic Settings]</p> <p>Mode : [RS232]</p> <p>WARNING: Disabling SIO Logical Devices may have unwanted side effects. PROCEED WITH CAUTION.</p>	<p>Enable or Disable this Logical Device.</p> <hr/> <p> ++: Select Screen T1: Select Item Enter: Select +/-: Change Opt. F1: General Help F2: Previous Values F3: Optimized Defaults F4: Save & Exit ESC: Exit </p>
------------------------------------------------------------------------------------------------------------------------------------------------------------------------------------------------------------------------------------------------------------------------------------------------------------	---------------------------------------------------------------------------------------------------------------------------------------------------------------------------------------------------------------------------------------------------------------------------------------------------------------------------------------------------------------------------------------------------------------------------------------------------------------------

Version 2.20.1275. Copyright (C) 2019 American Megatrends, Inc.

Options Summary		
Use This Device	Enabled	Optimal Default, Failsafe Default
	Disabled	
Enabled or Disabled this Logical Device.		
Device resource settings	USB Automatic Setting	Optimal Default, Failsafe Default
	IO=2D0h; IRQ = 11;	
	IO=2C0h; IRQ = 11;	
Allows the user to change the device resource settings. New settings will be reflected on this setup page after system restarts.		
UART selection	RS232	Optimal Default, Failsafe Default
	RS422	
	RS485	
UART RS232, 422, 485 selection.		

3.4.7.6 Serial Port 6 Configuration

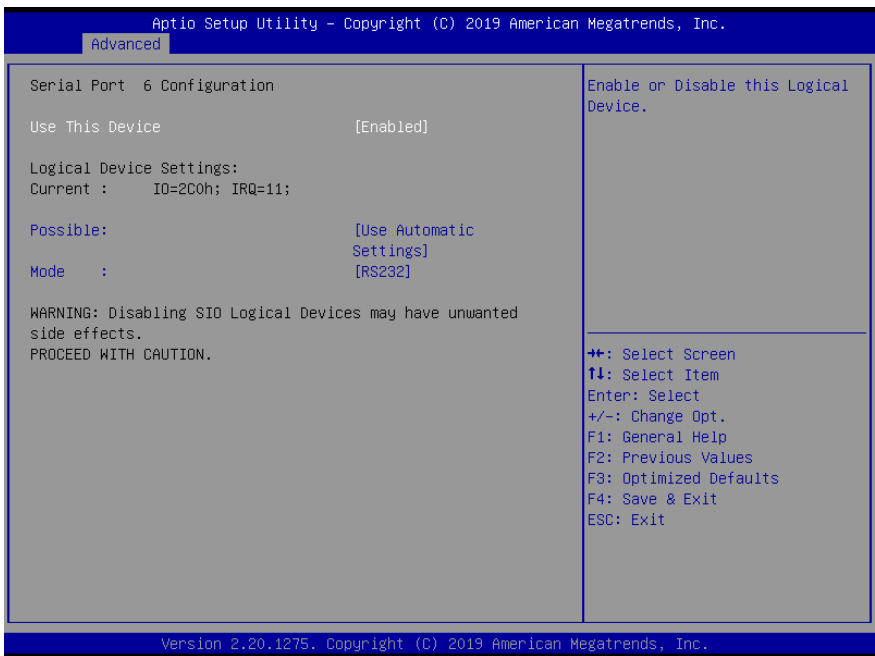

Options Summary		
Use This Device	Enabled	Optimal Default, Failsafe Default
	Disabled	
Enabled or Disabled this Logical Device.		
Device resource settings	USB Automatic Setting	Optimal Default, Failsafe Default
	IO=2C0h; IRQ = 11;	
	IO=2D0h; IRQ = 11;	
Allows the user to change the device resource settings. New settings will be reflected on this setup page after system restarts.		
UART selection	RS232	Optimal Default, Failsafe Default
	RS422	
	RS485	
UART RS232, 422, 485 selection.		

3.4.8 Advanced: Network Stack Configuration

Network Stack Disabled:

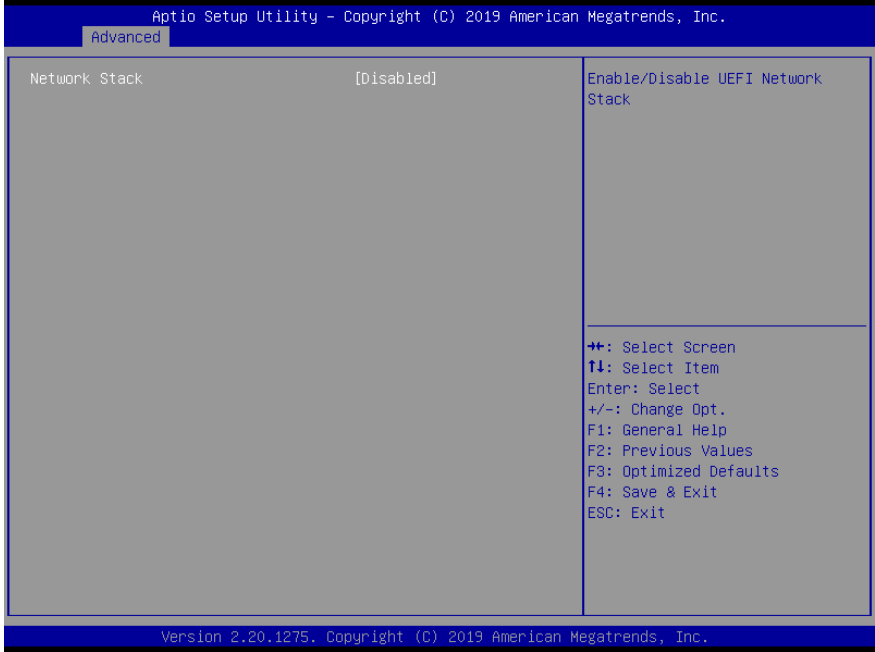

Options Summary		
Network Stack	Disabled	Optimal Default, Failsafe Default
	Enabled	
Enable/Disable UEFI Network Stack		

Network Stack Enabled:

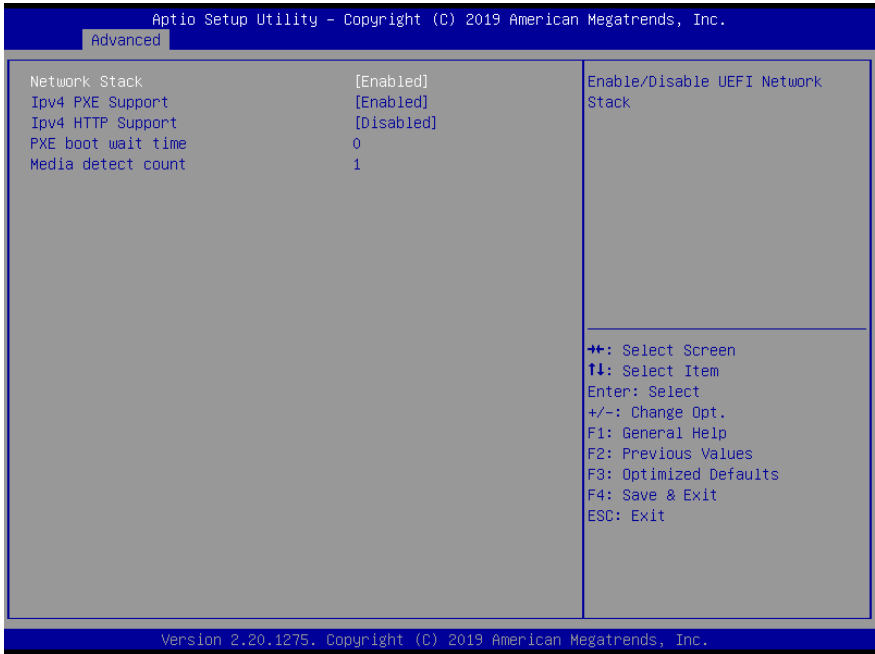

Options Summary		
Network Stack	Disabled	Optimal Default, Failsafe Default
	Enabled	
Enable/Disable UEFI Network Stack		
Ipv4 PXE Support	Disabled	Optimal Default, Failsafe Default
	Enabled	
Enable/Disable IPv4 PXE boot support. If disabled, IPv4 PXE boot support will not be available.		
Ipv4 HTTP Support	Disabled	Optimal Default, Failsafe Default
	Enabled	
Enable/Disable IPv4 HTTP boot support. If disabled, IPv4 HTTP boot support will not be available.		
PXE boot wait time	0	Optimal Default, Failsafe Default
Wait time in seconds to press ESC key to abort the PXE boot. Use either +/- or numeric keys to set the value.		

Table Continues on Next Page...

Options Summary

Media detect count	1	Optimal Default, Failsafe Default
Number of times the presence of media will be checked. Use either +/- or numeric keys to set the value.		

3.4.9 Advanced: Digital IO Port Configuration

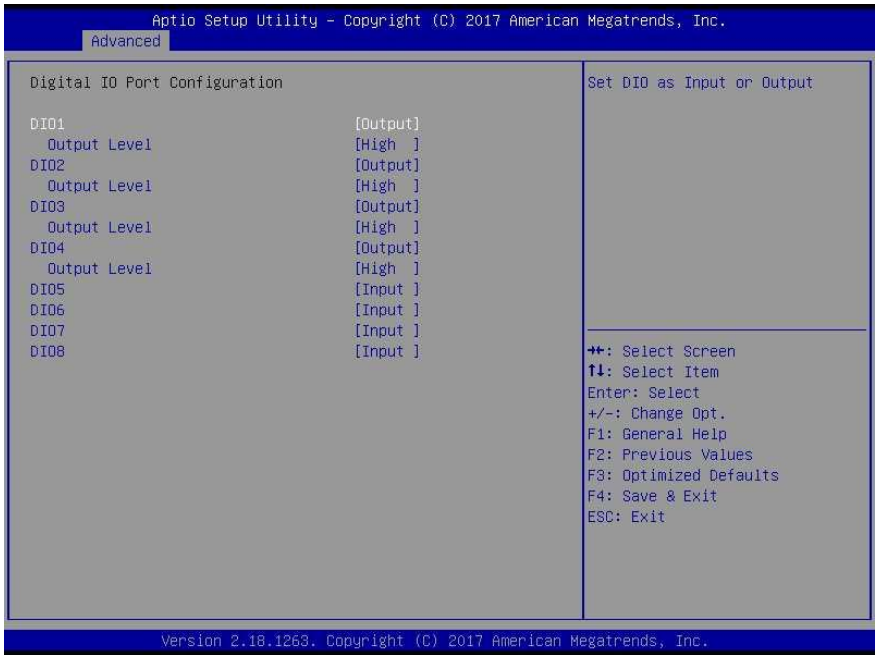

Options Summary		
DIO Type	Output	Optimal Default, Failsafe Default
	Input	
Set DIO as Input or Output		
DIO Data	Low	Optimal Default, Failsafe Default
	High	
Set is output level when DIO pin is output		

3.4.10 Advanced: Power Management

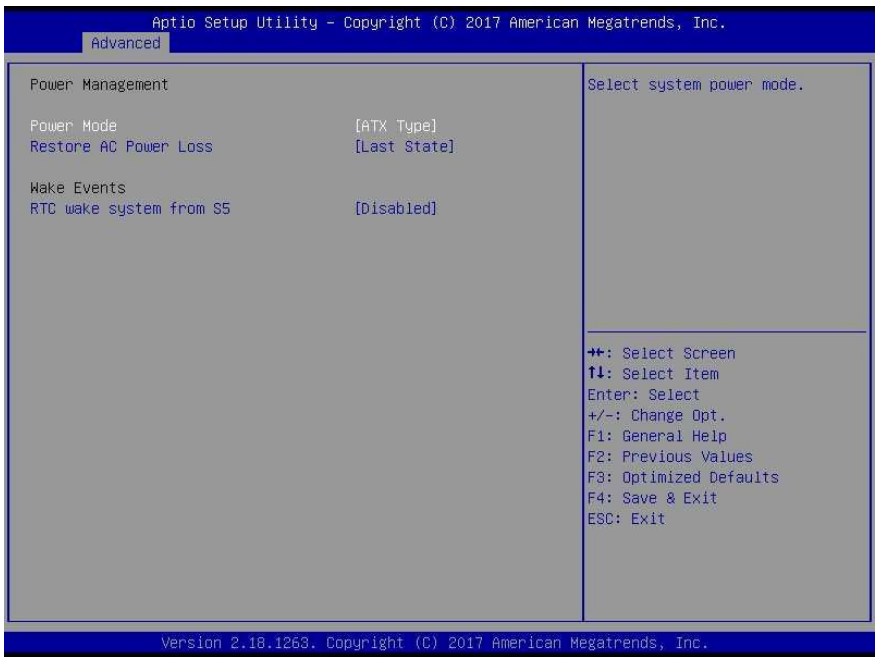

Options Summary		
Power Mode	ATX Type	Optimal Default, Failsafe Default
	AT Type	
Select power supply mode.		
AC Power Loss	Last State	Optimal Default, Failsafe Default
	Power On	
	Power Off	
Select power state when power is re-applied after a power failure.		
RTC wake system from S5	Disabled	Optimal Default, Failsafe Default
	Enabled	
Fixed Time: System will make on the hr::min::sec specified. Dynamic Time: System will wake on the current time + Increase minute(S)		
RTC wake system from S5	Enabled	
Wake up day	0	
Select 0 for daily system wake up, 1-31 for which day of the month that you would like system to wake up		

Options Summary	
Wake up hour	0
Select 0-23; For example enter 3 for 3am and 15 for 3pm	
Wake up minute	0
0 – 59	
Wake up second	0
0 - 59	

3.5 Setup Submenu: Chipset

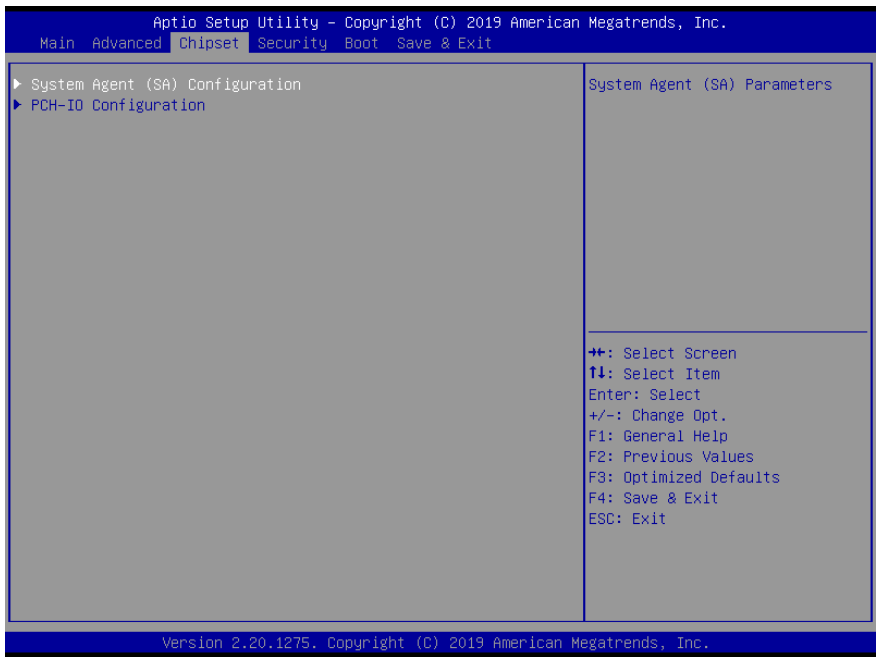

3.5.1 Chipset: System Agent (SA) Configuration

Aptio Setup Utility - Copyright (C) 2021 American Megatrends, Inc.

Chipset

System Agent (SA) Configuration		System Agent Geyserville. Fixed Low/Mid/High: SA GV disabled, MRC only runs tasks from Low, Mid, or High point. SA GV will be disabled on DT/Halo CPUs, regardless of this setting.
Total Memory	4096 MB	
Memory Frequency	2133 MHz	++: Select Screen T1: Select Item Enter: Select +/-: Change Opt. F1: General Help F2: Previous Values F3: Optimized Defaults F4: Save & Exit ESC: Exit
Memory Timings (tCL-tRCD-tRP-tRAS)	15-15-15-36	
Channel 0 Slot 0	Not Populated / Disabled	
Channel 1 Slot 0	Populated & Enabled	
Size	4096 MB (DDR4)	
Number of Ranks	1	
VT-d	Supported	
SA GV	[Enabled]	
PM Support	[Enabled]	
RC6(Render Standby)	[Enabled]	
DVMT Total Gfx Mem	[MAX]	
VT-d	[Disabled]	
Skip Scanning of External Gfx Card	[Disabled]	

Version 2.20.1275. Copyright (C) 2021 American Megatrends, Inc.

Options Summary		
SA GV	Enabled	Optimal Default, Failsafe Default
	Disabled	
	Fixed Low	
	Fixed High	
System Agent Geyserville. Fixed Low/Mid/High: SA GV disabled, MRC only runs tasks from Low, Mid, or High point. SA GV will be disabled on DT/Halo CPUs, regardless of this setting.		
PM Support	Enabled	Optimal Default, Failsafe Default
	Disabled	
Enable/Disable PM Support.		
RC6(Render Standby)	Enabled	Optimal Default, Failsafe Default
	Disabled	
Check to enable render standby support.		

Table Continues on Next Page...

Options Summary		
DVMT Total Gfx Mem	128M	Optimal Default, Failsafe Default
	256M	
	MAX	
Select DVMT5.0 Total Graphic Memory sized used by the Internal Graphics Device.		
VT-d	Enabled	Optimal Default, Failsafe Default
	Disabled	
VT-d capability.		
Skip Scanning of External Gfx Card	Enabled	Optimal Default, Failsafe Default
	Disabled	
If Enabled, it will not scan for External Gfx Card on PEG and PCH PCIE Ports		

3.5.2 Chipset: PCH-IO Configuration

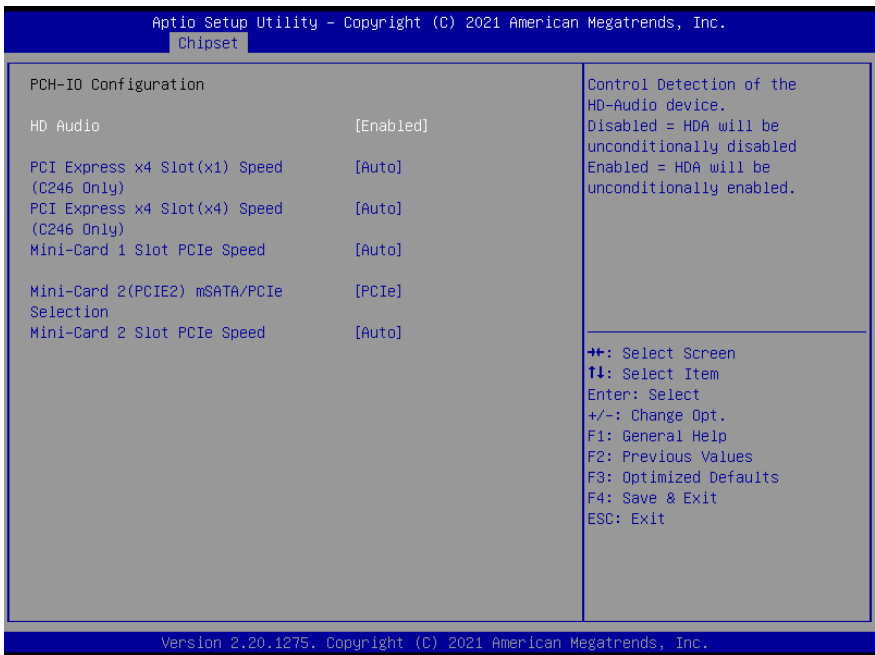

Options Summary		
HD Audio	Enabled	Optimal Default, Failsafe Default
	Disabled	
Control the Detection of the Audio device. Disabled = HDA will be unconditionally disabled. Enabled = HDA will be unconditionally enabled.		
PCI Express x4 Slot(x1) Speed (C246 Only)	Auto	Optimal Default, Failsafe Default
	Gen 1	
	Gen 2	
	Gen 3	
Configure PCIe Speed.		
PCI Express x4 Slot(x4) Speed (C246 Only)	Auto	Optimal Default, Failsafe Default
	Gen 1	
	Gen 2	
	Gen 3	
Configure PCIe Speed.		

Options Summary		
Mini-Card 1 Slot PCIe Speed	Auto	Optimal Default, Failsafe Default
	Gen 1	
	Gen 2	
Configure PCIe Speed.		
Mini-Card 2(PCIE2) mSATA/PCIe Selection	mSATA	Optimal Default, Failsafe Default
	PCIe	
Select mSATA or PCIe function for Mini-Card 2(PCIE2).		
Mini-Card 2 Slot PCIe Speed	Auto	Optimal Default, Failsafe Default
	Gen1	
	Gen2	
Configure PCIe Speed (Note: This setup will show when setup "Mini-Card 2(PCIE2) mSATA/PCIe Selection" is PCIe)		

3.6.1 Security: Secure Boot

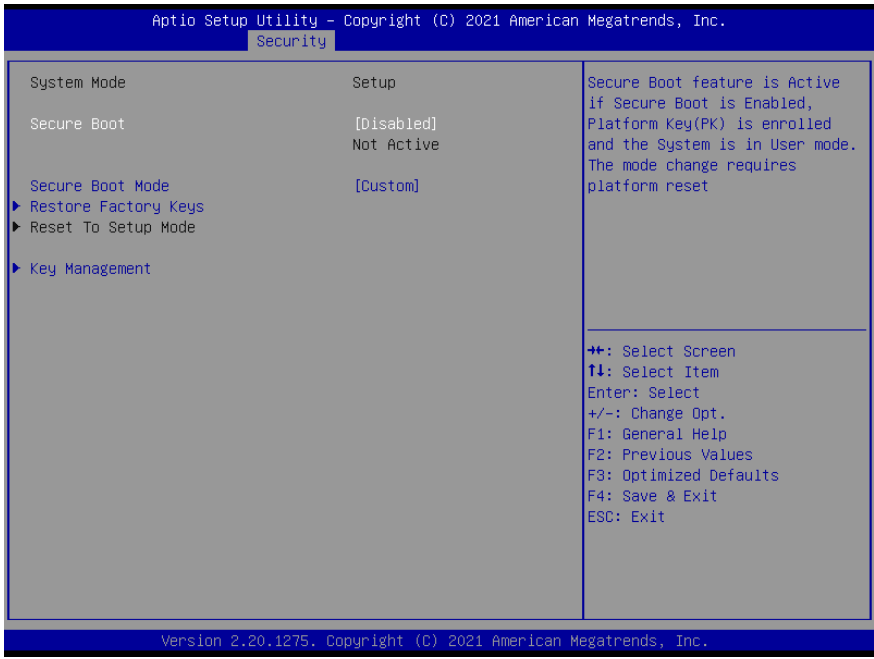

Options Summary		
Secure Boot	Disable	Optimal Default, Failsafe Default
	Enable	
Secure Boot feature is Active if Secure Boot is Enabled, Platform Key (PK) is enrolled and the System mode is in User mode. The mode change requires platform reset.		
Secure Boot Mode	Standard	Optimal Default, Failsafe Default
	Custom	
Secure Boot Mode options: Standard or Custom. In Custom mode, Secure Boot Policy variables can be configured by a physically present user without full authentication.		
Restore Factory Keys	Yes	
	No	
Force System to User Mode. Install factory default Secure Boot key databases		
Reset To Setup Mode	No	Deleting all variables will reset the System to Setup Mode
	Yes	
Delete all Secure Boot key databases from NVRAM.		

Table Continues on Next Page...

Options Summary

Key Management

Enables expert users to modify Secure Boot Policy variables without full authentication

3.6.1.1 Key Management

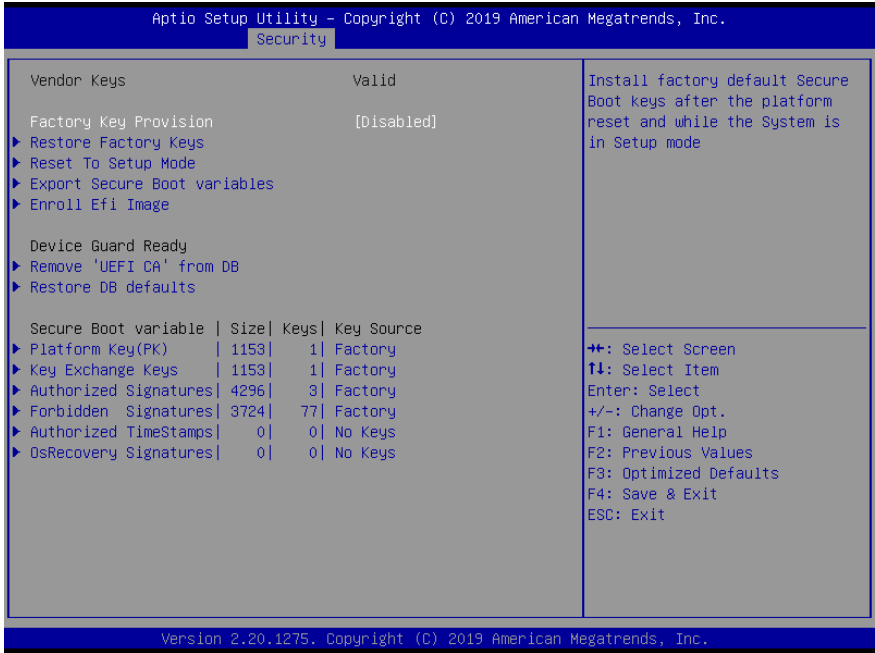

Options Summary

Factory key Provision	Disabled	Optimal Default, Failsafe Default
	Enabled	
Install factory default Secure Boot keys after the platform reset and while the System is in Setup mode.		
Restore Factory Keys	No	Press 'Yes' to install factory default keys
	Yes	
Force System to User Mode. Install Factory default Secure Boot key databases.		
Reset To Setup Mode	No	Deleting all variables will reset the System to Setup Mode.
	Yes	
Delete all Secure Boot key databases from NVRAM.		
Export Secure Boot variables		
Copy NVRAM content of Secure Boot variables to files in a root folder on a file system device.		

Options Summary	
Enroll Efi Image	
Allow the image to run in Secure Boot mode. Enroll SHA256 Hash Certificate of a PE Image into Authorized Signature Database (db).	

Device Guard Ready		
Remove 'UEFI CA' from SB	No	Press 'Yes' to remove 'UEFI CA' from SB
	Yes	
Device Guard ready system must not list 'Microsoft UEFI CA' Certificate in Authorized Signature database(db).		
Restore DB defaults	No	Press 'Yes' to Restore DB defaults
	Yes	
Restore DB variable to factory defaults.		

Secure Boot variable Size Keys# key Source		
Platform key(PK) 1153 1 No Key	Details	Enroll Factory Defaults or load certificates from a file: 1.Public key Certificate: a)EFI_SIGNATURE_LIST b)EFI_CERT_X509 (DER) c)EFI_CERT_RSA2048 (bin) d)EFI_CERT_SHAXXX 2.Authenticated UEFI Variable 3.EFI PE/COFF Image(SHA256) Key Source: Factory, External, Mixed
	Export	
	Update	
	Delete	
Key Exchange keys 1153 1 No Key	Details	Enroll Factory Defaults or load certificates from a file: 1.Public key Certificate: a)EFI_SIGNATURE_LIST b)EFI_CERT_X509 (DER) c)EFI_CERT_RSA2048 (bin) d)EFI_CERT_SHAXXX 2.Authenticated UEFI Variable 3.EFI PE/COFF Image(SHA256) Key Source: Factory, External, Mixed
	Export	
	Update	
	Append	
	Delete	

Table Continues on Next Page...

Secure Boot variable Size Keys# key Source		
Authorized Signatures 4296 3 No Key	Details	Enroll Factory Defaults or load certificates from a file: 1.Public key Certificate: a)EFI_SIGNATURE_LIST b)EFI_CERT_X509 (DER) c)EFI_CERT_RSA2048 (bin) d)EFI_CERT_SHAXXX 2.Authenticated UEFI Variable 3.EFI PE/COFF Image(SHA256) Key Source: Factory, External, Mixed
	Export	
	Update	
	Append	
	Delete	
Forbidden Signatures 3274 77 No Key	Details	Enroll Factory Defaults or load certificates from a file: 1.Public key Certificate: a)EFI_SIGNATURE_LIST b)EFI_CERT_X509 (DER) c)EFI_CERT_RSA2048 (bin) d)EFI_CERT_SHAXXX 2.Authenticated UEFI Variable 3.EFI PE/COFF Image(SHA256) Key Source: Factory, External, Mixed
	Export	
	Update	
	Append	
	Delete	
Authorized TimeStamps 0 0 No Key	Update	Enroll Factory Defaults or load certificates from a file: 1.Public key Certificate: a)EFI_SIGNATURE_LIST b)EFI_CERT_X509 (DER) c)EFI_CERT_RSA2048 (bin) d)EFI_CERT_SHAXXX 2.Authenticated UEFI Variable 3.EFI PE/COFF Image(SHA256) Key Source: Factory, External, Mixed
	Append	

Table Continues on Next Page

Secure Boot variable	Size	Keys#	key Source
OsRecovery Signatures 0 0 No Key	Update		Enroll Factory Defaults or load certificates from a file: 1.Public key Certificate: a)EFI_SIGNATURE_LIST b)EFI_CERT_X509 (DER) c)EFI_CERT_RSA2048 (bin) d)EFI_CERT_SHAXXX 2.Authenticated UEFI Variable 3.EFI PE/COFF Image(SHA256) Key Source: Factory, External, Mixed
	Append		

3.7 Setup Submenu: Boot

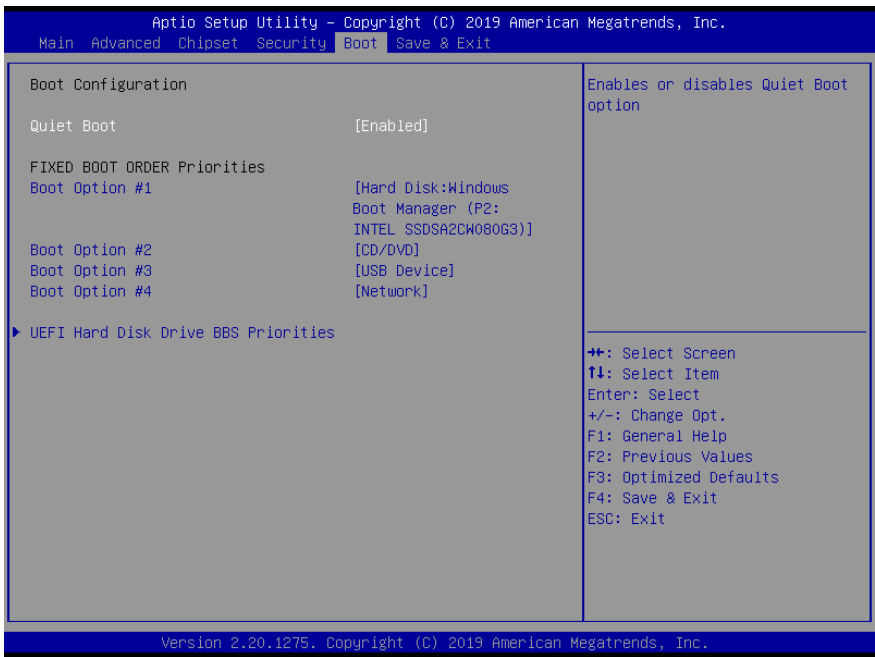

Options Summary

Quiet Boot	Disabled	Optimal Default, Failsafe Default
	Enabled	
Enables or disables Quiet Boot option.		

3.8 Setup Submenu: Save & Exit

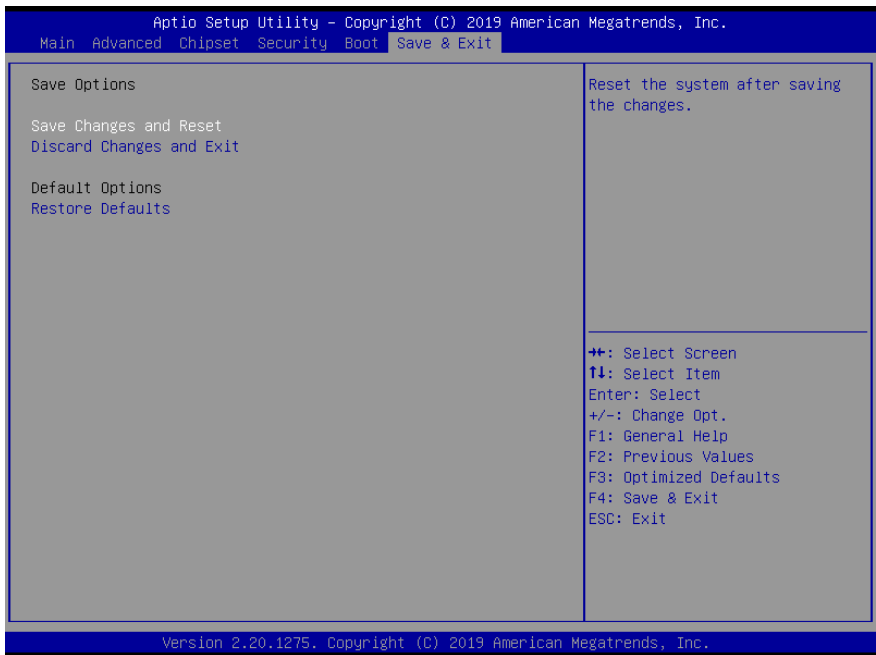

Chapter 4

Drivers Installation

4.1 Drivers Download and Installation

Drivers for the BOXER-6839-CFL can be downloaded from the product page on the AAEON website by following this link:

<https://www.aaeon.com/en/p/fanless-embedded-box-pc-socket-type-boxer-6839-CFL>

Download the driver(s) you need and follow the steps below to install them.

Install Chipset Drivers

1. Open the **Step1 - Chipset** folder and select your OS
2. Run the **SetupChipset.exe** file in the folder
3. Follow the instructions
4. Drivers will be installed automatically

Install Graphics Drivers

1. Open the **Step2 - Graphic** folder and select your OS
2. Run the **igxpın.exe** file in the folder
3. Follow the instructions
4. Drivers will be installed automatically

Install ME Drivers

1. Open the **Step3 - ME** folder and select your OS
2. Run the **SetupME.exe** file in the folder
3. Follow the instructions
4. Drivers will be installed automatically

Install LAN Drivers

1. Open the **Step4 - LAN** folder and select your OS
2. Run the **PROWinx64_23.5.2.exe** file in the folder
3. Follow the instructions
4. Drivers will be installed automatically

Install Audio Drivers

1. Open the **Step5 – Audio** folder and select your OS
2. Run the **0008-64bit_Win7_Win8_Win81_Win10_R281.exe** file in the folder
3. Follow the instructions
4. Drivers will be installed automatically

Install Intel RST Drivers

1. Open the **Step6 – Intel RST** folder and select your OS
2. Run the **SetupRST.exe** file in the folder
3. Follow the instructions
4. Drivers will be installed automatically

Install Serial Port Drivers (Optional)

1. Open the **Step7 – Serial Port Driver (Optional)** folder
2. Run the **FintekSerial.exe** file in the folder
3. Follow the instructions
4. Drivers will be installed automatically

Appendix A

Watchdog Timer Programming

A.1 Watchdog Timer Initial Program

Table 1: Super IO relative register table		
	Default Value	Note
Index	0x2E(Note1)	SIO MB PnP Mode Index Register 0x2E or 0x4E
Data	0x2F(Note2)	SIO MB PnP Mode Data Register 0x2F or 0x4F

Table 2: Watchdog relative register table					
	LDN	Register	BitNum	Value	Note
Timer Counter	0x07(Note3)	0xF6(Note4)		(Note24)	Time of watchdog timer (0~255) This register is byte access
Counting Unit	0x07(Note5)	0xF5(Note6)	3(Note7)	0(Note8)	Select time unit. 0: second 1: minute
Watchdog Enable	0x07(Note9)	0xF5(Note10)	5(Note11)	1(Note12)	0: Disable 1: Enable
Timeout Status	0x07(Note13)	0xF5(Note14)	6(Note15)	1	1: Clear timeout status
Output Mode	0x07(Note16)	0xF5(Note17)	4(Note18)	1(Note19)	Select WDRST# output mode 0: level 1: pulse
WDRST output	0x07(Note20)	0xFA(Note21)	0(Note22)	1(Note23)	Enable/Disable time out output via WDRST# 0: Disable 1: Enable

```

*****
// SuperIO relative definition (Please reference to Table 1)
#define byte SIOIndex //This parameter is represented from Note1
#define byte SIOData //This parameter is represented from Note2
#define void IOWriteByte(byte IOPort, byte Value);
#define byte IOReadByte(byte IOPort);
// Watch Dog relative definition (Please reference to Table 2)
#define byte TimerLDN //This parameter is represented from Note3
#define byte TimerReg //This parameter is represented from Note4
#define byte TimerVal // This parameter is represented from Note24
#define byte UnitLDN //This parameter is represented from Note5
#define byte UnitReg //This parameter is represented from Note6
#define byte UnitBit //This parameter is represented from Note7
#define byte UnitVal //This parameter is represented from Note8
#define byte EnableLDN //This parameter is represented from Note9
#define byte EnableReg //This parameter is represented from Note10
#define byte EnableBit //This parameter is represented from Note11
#define byte EnableVal //This parameter is represented from Note12
#define byte StatusLDN // This parameter is represented from Note13
#define byte StatusReg // This parameter is represented from Note14
#define byte StatusBit // This parameter is represented from Note15
#define byte ModeLDN // This parameter is represented from Note16
#define byte ModeReg // This parameter is represented from Note17
#define byte ModeBit // This parameter is represented from Note18
#define byte ModeVal // This parameter is represented from Note19
#define byte WDRstLDN // This parameter is represented from Note20
#define byte WDRstReg // This parameter is represented from Note21
#define byte WDRstBit // This parameter is represented from Note22
#define byte WDRstVal // This parameter is represented from Note23
*****

```

```
*****
VOID Main() {
    // Procedure : AaeonWDTConfig
    // (byte)Timer : Time of WDT timer.(0x00~0xFF)
    // (boolean)Unit : Select time unit(0: second, 1: minute).
    AaeonWDTConfig();

    // Procedure : AaeonWDTEnable
    // This procedure will enable the WDT counting.
    AaeonWDTEnable();
}
*****
```

```

*****
// Procedure : AaeonWDTEnable
VOID AaeonWDTEnable (){
    WDTEnableDisable(EnableLDN, EnableReg, EnableBit, 1);
}

// Procedure : AaeonWDTConfig
VOID AaeonWDTConfig (){
    // Disable WDT counting
    WDTEnableDisable(EnableLDN, EnableReg, EnableBit, 0);
    // Clear Watchdog Timeout Status
    WDTClearTimeoutStatus();
    // WDT relative parameter setting
    WDTParameterSetting();
}

VOID WDTEnableDisable(byte LDN, byte Register, byte BitNum, byte Value){
    SIOBitSet(LDN, Register, BitNum, Value);
}

VOID WDTParameterSetting(){
    // Watchdog Timer counter setting
    SIOByteSet(TimerLDN, TimerReg, TimerVal);
    // WDT counting unit setting
    SIOBitSet(UnitLDN, UnitReg, UnitBit, UnitVal);
    // WDT output mode setting, level / pulse
    SIOBitSet(ModeLDN, ModeReg, ModeBit, ModeVal);
    // Watchdog timeout output via WDTRST#
    SIOBitSet(WDTRstLDN, WDTRstReg, WDTRstBit, WDTRstVal);
}

VOID WDTClearTimeoutStatus(){
    SIOBitSet(StatusLDN, StatusReg, StatusBit, 1);
}
*****

```

```
*****
```

```

VOID SIOEnterMBPnPMode(){
    IOWriteByte(SIOIndex, 0x87);
    IOWriteByte(SIOIndex, 0x87);
}

VOID SIOExitMBPnPMode(){
    IOWriteByte(SIOIndex, 0xAA);
}

VOID SIOSelectLDN(byte LDN){
    IOWriteByte(SIOIndex, 0x07); // SIO LDN Register Offset = 0x07
    IOWriteByte(SIOData, LDN);
}

VOID SIOBitSet(byte LDN, byte Register, byte BitNum, byte Value){
    Byte TmpValue;

    SIOEnterMBPnPMode();
    SIOSelectLDN(byte LDN);
    IOWriteByte(SIOIndex, Register);
    TmpValue = IOReadByte(SIOData);
    TmpValue &= ~(1 << BitNum);
    TmpValue |= (Value << BitNum);
    IOWriteByte(SIOData, TmpValue);
    SIOExitMBPnPMode();
}

VOID SIOByteSet(byte LDN, byte Register, byte Value){
    SIOEnterMBPnPMode();
    SIOSelectLDN(LDN);
    IOWriteByte(SIOIndex, Register);
    IOWriteByte(SIOData, Value);
    SIOExitMBPnPMode();
}









































```



















```
*****
```

Appendix B









































I/O Information











































B.1 I/O Address Map











































▼		Input/output (IO)
	[0000000000000000 - 000000000000CF7]	PCI Express Root Complex
	[0000000000000020 - 0000000000000021]	Programmable interrupt controller
	[0000000000000024 - 0000000000000025]	Programmable interrupt controller
	[0000000000000028 - 0000000000000029]	Programmable interrupt controller
	[000000000000002C - 000000000000002D]	Programmable interrupt controller
	[000000000000002E - 000000000000002F]	Motherboard resources
	[0000000000000030 - 0000000000000031]	Programmable interrupt controller
	[0000000000000034 - 0000000000000035]	Programmable interrupt controller
	[0000000000000038 - 0000000000000039]	Programmable interrupt controller
	[000000000000003C - 000000000000003D]	Programmable interrupt controller
	[0000000000000040 - 0000000000000043]	System timer
	[000000000000004E - 000000000000004F]	Motherboard resources
	[0000000000000050 - 0000000000000053]	System timer
	[0000000000000060 - 0000000000000060]	Standard PS/2 Keyboard
	[0000000000000061 - 0000000000000061]	Motherboard resources
	[0000000000000063 - 0000000000000063]	Motherboard resources
	[0000000000000064 - 0000000000000064]	Standard PS/2 Keyboard
	[0000000000000065 - 0000000000000065]	Motherboard resources
	[0000000000000067 - 0000000000000067]	Motherboard resources
	[0000000000000070 - 0000000000000070]	Motherboard resources
	[0000000000000080 - 0000000000000080]	Motherboard resources
	[0000000000000092 - 0000000000000092]	Motherboard resources
	[00000000000000A0 - 00000000000000A1]	Programmable interrupt controller
	[00000000000000A4 - 00000000000000A5]	Programmable interrupt controller
	[00000000000000A8 - 00000000000000A9]	Programmable interrupt controller
	[00000000000000AC - 00000000000000AD]	Programmable interrupt controller
	[00000000000000B0 - 00000000000000B1]	Programmable interrupt controller
	[00000000000000B2 - 00000000000000B3]	Motherboard resources
	[00000000000000B4 - 00000000000000B5]	Programmable interrupt controller
	[00000000000000B8 - 00000000000000B9]	Programmable interrupt controller
	[00000000000000BC - 00000000000000BD]	Programmable interrupt controller
	[00000000000000F0 - 00000000000000F0]	Numeric data processor
	[00000000000002C0 - 00000000000002C7]	Fintek Communications Port (COM6)
	[00000000000002D0 - 00000000000002D7]	Fintek Communications Port (COM5)
	[00000000000002E8 - 00000000000002EF]	Fintek Communications Port (COM4)
	[00000000000002F8 - 00000000000002FF]	Fintek Communications Port (COM2)
	[00000000000003E8 - 00000000000003EF]	Fintek Communications Port (COM3)
	[00000000000003F8 - 00000000000003FF]	Fintek Communications Port (COM1)
	[00000000000004D0 - 00000000000004D1]	Programmable interrupt controller
	[0000000000000680 - 000000000000069F]	Motherboard resources











































	[0000000000000680 - 000000000000069F]	Motherboard resources
	[000000000000A00 - 000000000000A0F]	Motherboard resources
	[000000000000A10 - 000000000000A1F]	Motherboard resources
	[000000000000A20 - 000000000000A2F]	Motherboard resources
	[000000000000D00 - 000000000000FFFF]	PCI Express Root Complex
	[000000000000164E - 000000000000164F]	Motherboard resources
	[0000000000001800 - 00000000000018FE]	Motherboard resources
	[0000000000001854 - 0000000000001857]	Motherboard resources
	[0000000000002000 - 00000000000020FE]	Motherboard resources
	[0000000000003000 - 0000000000003FFF]	Intel(R) PCI Express Root Port #8 - A33F
	[0000000000004000 - 0000000000004FFF]	Intel(R) PCI Express Root Port #7 - A33E
	[0000000000005000 - 0000000000005FFF]	Intel(R) PCI Express Root Port #6 - A33D
	[0000000000006000 - 000000000000603F]	Intel(R) UHD Graphics 630
	[0000000000006060 - 000000000000607F]	Intel(R) 300 Series Chipset Family SATA AHCI Controller
	[0000000000006080 - 0000000000006083]	Intel(R) 300 Series Chipset Family SATA AHCI Controller
	[0000000000006090 - 0000000000006097]	Intel(R) 300 Series Chipset Family SATA AHCI Controller
	[000000000000EFA0 - 000000000000EFBF]	Intel(R) SMBus - A323
	[000000000000FFF8 - 000000000000FFFF]	Intel(R) Active Management Technology - SOL (COM7)











































B.2 IRQ Mapping Chart









































Interrupt request (IRQ)	
	(ISA) 0x00000000 (00) System timer
	(ISA) 0x00000001 (01) Standard PS/2 Keyboard
	(ISA) 0x00000003 (03) Fintek Communications Port (COM2)
	(ISA) 0x00000004 (04) Fintek Communications Port (COM1)
	(ISA) 0x0000000B (11) Fintek Communications Port (COM3)
	(ISA) 0x0000000B (11) Fintek Communications Port (COM4)
	(ISA) 0x0000000B (11) Fintek Communications Port (COM5)
	(ISA) 0x0000000B (11) Fintek Communications Port (COM6)
	(ISA) 0x0000000C (12) PS/2 Compatible Mouse
	(ISA) 0x0000000D (13) Numeric data processor
	(ISA) 0x0000000E (14) Intel(R) Serial IO GPIO Host Controller - INT3450
	(ISA) 0x00000036 (54) Microsoft ACPI-Compliant System
	(ISA) 0x00000037 (55) Microsoft ACPI-Compliant System
	(ISA) 0x00000038 (56) Microsoft ACPI-Compliant System
	(ISA) 0x00000039 (57) Microsoft ACPI-Compliant System
	(ISA) 0x0000003A (58) Microsoft ACPI-Compliant System
	(ISA) 0x0000003B (59) Microsoft ACPI-Compliant System
	(ISA) 0x0000003C (60) Microsoft ACPI-Compliant System
	(ISA) 0x0000003D (61) Microsoft ACPI-Compliant System
	(ISA) 0x0000003E (62) Microsoft ACPI-Compliant System
	(ISA) 0x0000003F (63) Microsoft ACPI-Compliant System
	(ISA) 0x00000040 (64) Microsoft ACPI-Compliant System
	(ISA) 0x00000041 (65) Microsoft ACPI-Compliant System
	(ISA) 0x00000042 (66) Microsoft ACPI-Compliant System
	(ISA) 0x00000043 (67) Microsoft ACPI-Compliant System
	(ISA) 0x00000044 (68) Microsoft ACPI-Compliant System
	(ISA) 0x00000045 (69) Microsoft ACPI-Compliant System
	(ISA) 0x00000046 (70) Microsoft ACPI-Compliant System
	(ISA) 0x00000047 (71) Microsoft ACPI-Compliant System
	(ISA) 0x00000048 (72) Microsoft ACPI-Compliant System
	(ISA) 0x00000049 (73) Microsoft ACPI-Compliant System
	(ISA) 0x0000004A (74) Microsoft ACPI-Compliant System
	(ISA) 0x0000004B (75) Microsoft ACPI-Compliant System
	(ISA) 0x0000004C (76) Microsoft ACPI-Compliant System
	(ISA) 0x0000004D (77) Microsoft ACPI-Compliant System
	(ISA) 0x0000004E (78) Microsoft ACPI-Compliant System
	(ISA) 0x0000004F (79) Microsoft ACPI-Compliant System
	(ISA) 0x00000050 (80) Microsoft ACPI-Compliant System
	(ISA) 0x00000051 (81) Microsoft ACPI-Compliant System
	(ISA) 0x00000052 (82) Microsoft ACPI-Compliant System
	(ISA) 0x00000053 (83) Microsoft ACPI-Compliant System









































 (ISA) 0x00000053 (83)	Microsoft ACPI-Compliant System
 (ISA) 0x00000054 (84)	Microsoft ACPI-Compliant System
 (ISA) 0x00000055 (85)	Microsoft ACPI-Compliant System
 (ISA) 0x00000056 (86)	Microsoft ACPI-Compliant System
 (ISA) 0x00000057 (87)	Microsoft ACPI-Compliant System
 (ISA) 0x00000058 (88)	Microsoft ACPI-Compliant System
 (ISA) 0x00000059 (89)	Microsoft ACPI-Compliant System
 (ISA) 0x0000005A (90)	Microsoft ACPI-Compliant System
 (ISA) 0x0000005B (91)	Microsoft ACPI-Compliant System
 (ISA) 0x0000005C (92)	Microsoft ACPI-Compliant System
 (ISA) 0x0000005D (93)	Microsoft ACPI-Compliant System
 (ISA) 0x0000005E (94)	Microsoft ACPI-Compliant System
 (ISA) 0x0000005F (95)	Microsoft ACPI-Compliant System
 (ISA) 0x00000060 (96)	Microsoft ACPI-Compliant System
 (ISA) 0x00000061 (97)	Microsoft ACPI-Compliant System
 (ISA) 0x00000062 (98)	Microsoft ACPI-Compliant System
 (ISA) 0x00000063 (99)	Microsoft ACPI-Compliant System
 (ISA) 0x00000064 (100)	Microsoft ACPI-Compliant System
 (ISA) 0x00000065 (101)	Microsoft ACPI-Compliant System
 (ISA) 0x00000066 (102)	Microsoft ACPI-Compliant System
 (ISA) 0x00000067 (103)	Microsoft ACPI-Compliant System
 (ISA) 0x00000068 (104)	Microsoft ACPI-Compliant System
 (ISA) 0x00000069 (105)	Microsoft ACPI-Compliant System
 (ISA) 0x0000006A (106)	Microsoft ACPI-Compliant System
 (ISA) 0x0000006B (107)	Microsoft ACPI-Compliant System
 (ISA) 0x0000006C (108)	Microsoft ACPI-Compliant System
 (ISA) 0x0000006D (109)	Microsoft ACPI-Compliant System
 (ISA) 0x0000006E (110)	Microsoft ACPI-Compliant System
 (ISA) 0x0000006F (111)	Microsoft ACPI-Compliant System
 (ISA) 0x00000070 (112)	Microsoft ACPI-Compliant System
 (ISA) 0x00000071 (113)	Microsoft ACPI-Compliant System
 (ISA) 0x00000072 (114)	Microsoft ACPI-Compliant System
 (ISA) 0x00000073 (115)	Microsoft ACPI-Compliant System
 (ISA) 0x00000074 (116)	Microsoft ACPI-Compliant System
 (ISA) 0x00000075 (117)	Microsoft ACPI-Compliant System
 (ISA) 0x00000076 (118)	Microsoft ACPI-Compliant System
 (ISA) 0x00000077 (119)	Microsoft ACPI-Compliant System
 (ISA) 0x00000078 (120)	Microsoft ACPI-Compliant System
 (ISA) 0x00000079 (121)	Microsoft ACPI-Compliant System
 (ISA) 0x0000007A (122)	Microsoft ACPI-Compliant System
 (ISA) 0x0000007B (123)	Microsoft ACPI-Compliant System
 (ISA) 0x0000007C (124)	Microsoft ACPI-Compliant System











































 (ISA) 0x0000007C (124)	Microsoft ACPI-Compliant System
 (ISA) 0x0000007D (125)	Microsoft ACPI-Compliant System
 (ISA) 0x0000007E (126)	Microsoft ACPI-Compliant System
 (ISA) 0x0000007F (127)	Microsoft ACPI-Compliant System
 (ISA) 0x00000080 (128)	Microsoft ACPI-Compliant System
 (ISA) 0x00000081 (129)	Microsoft ACPI-Compliant System
 (ISA) 0x00000082 (130)	Microsoft ACPI-Compliant System
 (ISA) 0x00000083 (131)	Microsoft ACPI-Compliant System
 (ISA) 0x00000084 (132)	Microsoft ACPI-Compliant System
 (ISA) 0x00000085 (133)	Microsoft ACPI-Compliant System
 (ISA) 0x00000086 (134)	Microsoft ACPI-Compliant System
 (ISA) 0x00000087 (135)	Microsoft ACPI-Compliant System
 (ISA) 0x00000088 (136)	Microsoft ACPI-Compliant System
 (ISA) 0x00000089 (137)	Microsoft ACPI-Compliant System
 (ISA) 0x0000008A (138)	Microsoft ACPI-Compliant System
 (ISA) 0x0000008B (139)	Microsoft ACPI-Compliant System
 (ISA) 0x0000008C (140)	Microsoft ACPI-Compliant System
 (ISA) 0x0000008D (141)	Microsoft ACPI-Compliant System
 (ISA) 0x0000008E (142)	Microsoft ACPI-Compliant System
 (ISA) 0x0000008F (143)	Microsoft ACPI-Compliant System
 (ISA) 0x00000090 (144)	Microsoft ACPI-Compliant System
 (ISA) 0x00000091 (145)	Microsoft ACPI-Compliant System
 (ISA) 0x00000092 (146)	Microsoft ACPI-Compliant System
 (ISA) 0x00000093 (147)	Microsoft ACPI-Compliant System
 (ISA) 0x00000094 (148)	Microsoft ACPI-Compliant System
 (ISA) 0x00000095 (149)	Microsoft ACPI-Compliant System
 (ISA) 0x00000096 (150)	Microsoft ACPI-Compliant System
 (ISA) 0x00000097 (151)	Microsoft ACPI-Compliant System
 (ISA) 0x00000098 (152)	Microsoft ACPI-Compliant System
 (ISA) 0x00000099 (153)	Microsoft ACPI-Compliant System
 (ISA) 0x0000009A (154)	Microsoft ACPI-Compliant System
 (ISA) 0x0000009B (155)	Microsoft ACPI-Compliant System
 (ISA) 0x0000009C (156)	Microsoft ACPI-Compliant System
 (ISA) 0x0000009D (157)	Microsoft ACPI-Compliant System
 (ISA) 0x0000009E (158)	Microsoft ACPI-Compliant System
 (ISA) 0x0000009F (159)	Microsoft ACPI-Compliant System
 (ISA) 0x000000A0 (160)	Microsoft ACPI-Compliant System
 (ISA) 0x000000A1 (161)	Microsoft ACPI-Compliant System
 (ISA) 0x000000A2 (162)	Microsoft ACPI-Compliant System
 (ISA) 0x000000A3 (163)	Microsoft ACPI-Compliant System
 (ISA) 0x000000A4 (164)	Microsoft ACPI-Compliant System
 (ISA) 0x000000A5 (165)	Microsoft ACPI-Compliant System











































 (ISA) 0x000000A5 (165)	Microsoft ACPI-Compliant System
 (ISA) 0x000000A6 (166)	Microsoft ACPI-Compliant System
 (ISA) 0x000000A7 (167)	Microsoft ACPI-Compliant System
 (ISA) 0x000000A8 (168)	Microsoft ACPI-Compliant System
 (ISA) 0x000000A9 (169)	Microsoft ACPI-Compliant System
 (ISA) 0x000000AA (170)	Microsoft ACPI-Compliant System
 (ISA) 0x000000AB (171)	Microsoft ACPI-Compliant System
 (ISA) 0x000000AC (172)	Microsoft ACPI-Compliant System
 (ISA) 0x000000AD (173)	Microsoft ACPI-Compliant System
 (ISA) 0x000000AE (174)	Microsoft ACPI-Compliant System
 (ISA) 0x000000AF (175)	Microsoft ACPI-Compliant System
 (ISA) 0x000000B0 (176)	Microsoft ACPI-Compliant System
 (ISA) 0x000000B1 (177)	Microsoft ACPI-Compliant System
 (ISA) 0x000000B2 (178)	Microsoft ACPI-Compliant System
 (ISA) 0x000000B3 (179)	Microsoft ACPI-Compliant System
 (ISA) 0x000000B4 (180)	Microsoft ACPI-Compliant System
 (ISA) 0x000000B5 (181)	Microsoft ACPI-Compliant System
 (ISA) 0x000000B6 (182)	Microsoft ACPI-Compliant System
 (ISA) 0x000000B7 (183)	Microsoft ACPI-Compliant System
 (ISA) 0x000000B8 (184)	Microsoft ACPI-Compliant System
 (ISA) 0x000000B9 (185)	Microsoft ACPI-Compliant System
 (ISA) 0x000000BA (186)	Microsoft ACPI-Compliant System
 (ISA) 0x000000BB (187)	Microsoft ACPI-Compliant System
 (ISA) 0x000000BC (188)	Microsoft ACPI-Compliant System
 (ISA) 0x000000BD (189)	Microsoft ACPI-Compliant System
 (ISA) 0x000000BE (190)	Microsoft ACPI-Compliant System
 (ISA) 0x000000BF (191)	Microsoft ACPI-Compliant System
 (ISA) 0x000000C0 (192)	Microsoft ACPI-Compliant System
 (ISA) 0x000000C1 (193)	Microsoft ACPI-Compliant System
 (ISA) 0x000000C2 (194)	Microsoft ACPI-Compliant System
 (ISA) 0x000000C3 (195)	Microsoft ACPI-Compliant System
 (ISA) 0x000000C4 (196)	Microsoft ACPI-Compliant System
 (ISA) 0x000000C5 (197)	Microsoft ACPI-Compliant System
 (ISA) 0x000000C6 (198)	Microsoft ACPI-Compliant System
 (ISA) 0x000000C7 (199)	Microsoft ACPI-Compliant System
 (ISA) 0x000000C8 (200)	Microsoft ACPI-Compliant System
 (ISA) 0x000000C9 (201)	Microsoft ACPI-Compliant System
 (ISA) 0x000000CA (202)	Microsoft ACPI-Compliant System
 (ISA) 0x000000CB (203)	Microsoft ACPI-Compliant System
 (ISA) 0x000000CC (204)	Microsoft ACPI-Compliant System
 (ISA) 0x00000100 (256)	Microsoft ACPI-Compliant System
 (ISA) 0x00000101 (257)	Microsoft ACPI-Compliant System











































 (ISA) 0x00000101 (257)	Microsoft ACPI-Compliant System
 (ISA) 0x00000102 (258)	Microsoft ACPI-Compliant System
 (ISA) 0x00000103 (259)	Microsoft ACPI-Compliant System
 (ISA) 0x00000104 (260)	Microsoft ACPI-Compliant System
 (ISA) 0x00000105 (261)	Microsoft ACPI-Compliant System
 (ISA) 0x00000106 (262)	Microsoft ACPI-Compliant System
 (ISA) 0x00000107 (263)	Microsoft ACPI-Compliant System
 (ISA) 0x00000108 (264)	Microsoft ACPI-Compliant System
 (ISA) 0x00000109 (265)	Microsoft ACPI-Compliant System
 (ISA) 0x0000010A (266)	Microsoft ACPI-Compliant System
 (ISA) 0x0000010B (267)	Microsoft ACPI-Compliant System
 (ISA) 0x0000010C (268)	Microsoft ACPI-Compliant System
 (ISA) 0x0000010D (269)	Microsoft ACPI-Compliant System
 (ISA) 0x0000010E (270)	Microsoft ACPI-Compliant System
 (ISA) 0x0000010F (271)	Microsoft ACPI-Compliant System
 (ISA) 0x00000110 (272)	Microsoft ACPI-Compliant System
 (ISA) 0x00000111 (273)	Microsoft ACPI-Compliant System
 (ISA) 0x00000112 (274)	Microsoft ACPI-Compliant System
 (ISA) 0x00000113 (275)	Microsoft ACPI-Compliant System
 (ISA) 0x00000114 (276)	Microsoft ACPI-Compliant System
 (ISA) 0x00000115 (277)	Microsoft ACPI-Compliant System
 (ISA) 0x00000116 (278)	Microsoft ACPI-Compliant System
 (ISA) 0x00000117 (279)	Microsoft ACPI-Compliant System
 (ISA) 0x00000118 (280)	Microsoft ACPI-Compliant System
 (ISA) 0x00000119 (281)	Microsoft ACPI-Compliant System
 (ISA) 0x0000011A (282)	Microsoft ACPI-Compliant System
 (ISA) 0x0000011B (283)	Microsoft ACPI-Compliant System
 (ISA) 0x0000011C (284)	Microsoft ACPI-Compliant System
 (ISA) 0x0000011D (285)	Microsoft ACPI-Compliant System
 (ISA) 0x0000011E (286)	Microsoft ACPI-Compliant System
 (ISA) 0x0000011F (287)	Microsoft ACPI-Compliant System
 (ISA) 0x00000120 (288)	Microsoft ACPI-Compliant System
 (ISA) 0x00000121 (289)	Microsoft ACPI-Compliant System
 (ISA) 0x00000122 (290)	Microsoft ACPI-Compliant System
 (ISA) 0x00000123 (291)	Microsoft ACPI-Compliant System
 (ISA) 0x00000124 (292)	Microsoft ACPI-Compliant System
 (ISA) 0x00000125 (293)	Microsoft ACPI-Compliant System
 (ISA) 0x00000126 (294)	Microsoft ACPI-Compliant System
 (ISA) 0x00000127 (295)	Microsoft ACPI-Compliant System
 (ISA) 0x00000128 (296)	Microsoft ACPI-Compliant System
 (ISA) 0x00000129 (297)	Microsoft ACPI-Compliant System
 (ISA) 0x0000012A (298)	Microsoft ACPI-Compliant System









































 (ISA) 0x0000012A (298)	Microsoft ACPI-Compliant System
 (ISA) 0x0000012B (299)	Microsoft ACPI-Compliant System
 (ISA) 0x0000012C (300)	Microsoft ACPI-Compliant System
 (ISA) 0x0000012D (301)	Microsoft ACPI-Compliant System
 (ISA) 0x0000012E (302)	Microsoft ACPI-Compliant System
 (ISA) 0x0000012F (303)	Microsoft ACPI-Compliant System
 (ISA) 0x00000130 (304)	Microsoft ACPI-Compliant System
 (ISA) 0x00000131 (305)	Microsoft ACPI-Compliant System
 (ISA) 0x00000132 (306)	Microsoft ACPI-Compliant System
 (ISA) 0x00000133 (307)	Microsoft ACPI-Compliant System
 (ISA) 0x00000134 (308)	Microsoft ACPI-Compliant System
 (ISA) 0x00000135 (309)	Microsoft ACPI-Compliant System
 (ISA) 0x00000136 (310)	Microsoft ACPI-Compliant System
 (ISA) 0x00000137 (311)	Microsoft ACPI-Compliant System
 (ISA) 0x00000138 (312)	Microsoft ACPI-Compliant System
 (ISA) 0x00000139 (313)	Microsoft ACPI-Compliant System
 (ISA) 0x0000013A (314)	Microsoft ACPI-Compliant System
 (ISA) 0x0000013B (315)	Microsoft ACPI-Compliant System
 (ISA) 0x0000013C (316)	Microsoft ACPI-Compliant System
 (ISA) 0x0000013D (317)	Microsoft ACPI-Compliant System
 (ISA) 0x0000013E (318)	Microsoft ACPI-Compliant System
 (ISA) 0x0000013F (319)	Microsoft ACPI-Compliant System
 (ISA) 0x00000140 (320)	Microsoft ACPI-Compliant System
 (ISA) 0x00000141 (321)	Microsoft ACPI-Compliant System
 (ISA) 0x00000142 (322)	Microsoft ACPI-Compliant System
 (ISA) 0x00000143 (323)	Microsoft ACPI-Compliant System
 (ISA) 0x00000144 (324)	Microsoft ACPI-Compliant System
 (ISA) 0x00000145 (325)	Microsoft ACPI-Compliant System
 (ISA) 0x00000146 (326)	Microsoft ACPI-Compliant System
 (ISA) 0x00000147 (327)	Microsoft ACPI-Compliant System
 (ISA) 0x00000148 (328)	Microsoft ACPI-Compliant System
 (ISA) 0x00000149 (329)	Microsoft ACPI-Compliant System
 (ISA) 0x0000014A (330)	Microsoft ACPI-Compliant System
 (ISA) 0x0000014B (331)	Microsoft ACPI-Compliant System
 (ISA) 0x0000014C (332)	Microsoft ACPI-Compliant System
 (ISA) 0x0000014D (333)	Microsoft ACPI-Compliant System
 (ISA) 0x0000014E (334)	Microsoft ACPI-Compliant System
 (ISA) 0x0000014F (335)	Microsoft ACPI-Compliant System
 (ISA) 0x00000150 (336)	Microsoft ACPI-Compliant System
 (ISA) 0x00000151 (337)	Microsoft ACPI-Compliant System
 (ISA) 0x00000152 (338)	Microsoft ACPI-Compliant System
(ISA) 0x00000153 (339)	Microsoft ACPI-Compliant System



 (ISA) 0x00000153 (339)	Microsoft ACPI-Compliant System
 (ISA) 0x00000154 (340)	Microsoft ACPI-Compliant System
 (ISA) 0x00000155 (341)	Microsoft ACPI-Compliant System
 (ISA) 0x00000156 (342)	Microsoft ACPI-Compliant System
 (ISA) 0x00000157 (343)	Microsoft ACPI-Compliant System
 (ISA) 0x00000158 (344)	Microsoft ACPI-Compliant System
 (ISA) 0x00000159 (345)	Microsoft ACPI-Compliant System
 (ISA) 0x0000015A (346)	Microsoft ACPI-Compliant System
 (ISA) 0x0000015B (347)	Microsoft ACPI-Compliant System
 (ISA) 0x0000015C (348)	Microsoft ACPI-Compliant System
 (ISA) 0x0000015D (349)	Microsoft ACPI-Compliant System
 (ISA) 0x0000015E (350)	Microsoft ACPI-Compliant System
 (ISA) 0x0000015F (351)	Microsoft ACPI-Compliant System
 (ISA) 0x00000160 (352)	Microsoft ACPI-Compliant System
 (ISA) 0x00000161 (353)	Microsoft ACPI-Compliant System
 (ISA) 0x00000162 (354)	Microsoft ACPI-Compliant System
 (ISA) 0x00000163 (355)	Microsoft ACPI-Compliant System
 (ISA) 0x00000164 (356)	Microsoft ACPI-Compliant System
 (ISA) 0x00000165 (357)	Microsoft ACPI-Compliant System
 (ISA) 0x00000166 (358)	Microsoft ACPI-Compliant System
 (ISA) 0x00000167 (359)	Microsoft ACPI-Compliant System
 (ISA) 0x00000168 (360)	Microsoft ACPI-Compliant System
 (ISA) 0x00000169 (361)	Microsoft ACPI-Compliant System
 (ISA) 0x0000016A (362)	Microsoft ACPI-Compliant System
 (ISA) 0x0000016B (363)	Microsoft ACPI-Compliant System
 (ISA) 0x0000016C (364)	Microsoft ACPI-Compliant System
 (ISA) 0x0000016D (365)	Microsoft ACPI-Compliant System
 (ISA) 0x0000016E (366)	Microsoft ACPI-Compliant System
 (ISA) 0x0000016F (367)	Microsoft ACPI-Compliant System
 (ISA) 0x00000170 (368)	Microsoft ACPI-Compliant System
 (ISA) 0x00000171 (369)	Microsoft ACPI-Compliant System
 (ISA) 0x00000172 (370)	Microsoft ACPI-Compliant System
 (ISA) 0x00000173 (371)	Microsoft ACPI-Compliant System
 (ISA) 0x00000174 (372)	Microsoft ACPI-Compliant System
 (ISA) 0x00000175 (373)	Microsoft ACPI-Compliant System
 (ISA) 0x00000176 (374)	Microsoft ACPI-Compliant System
 (ISA) 0x00000177 (375)	Microsoft ACPI-Compliant System
 (ISA) 0x00000178 (376)	Microsoft ACPI-Compliant System
 (ISA) 0x00000179 (377)	Microsoft ACPI-Compliant System
 (ISA) 0x0000017A (378)	Microsoft ACPI-Compliant System
 (ISA) 0x0000017B (379)	Microsoft ACPI-Compliant System
(ISA) 0x0000017C (380)	Microsoft ACPI-Compliant System

 (ISA) 0x000017C (380)	Microsoft ACPI-Compliant System
 (ISA) 0x000017D (381)	Microsoft ACPI-Compliant System
 (ISA) 0x000017E (382)	Microsoft ACPI-Compliant System
 (ISA) 0x000017F (383)	Microsoft ACPI-Compliant System
 (ISA) 0x0000180 (384)	Microsoft ACPI-Compliant System
 (ISA) 0x0000181 (385)	Microsoft ACPI-Compliant System
 (ISA) 0x0000182 (386)	Microsoft ACPI-Compliant System
 (ISA) 0x0000183 (387)	Microsoft ACPI-Compliant System
 (ISA) 0x0000184 (388)	Microsoft ACPI-Compliant System
 (ISA) 0x0000185 (389)	Microsoft ACPI-Compliant System
 (ISA) 0x0000186 (390)	Microsoft ACPI-Compliant System
 (ISA) 0x0000187 (391)	Microsoft ACPI-Compliant System
 (ISA) 0x0000188 (392)	Microsoft ACPI-Compliant System
 (ISA) 0x0000189 (393)	Microsoft ACPI-Compliant System
 (ISA) 0x000018A (394)	Microsoft ACPI-Compliant System
 (ISA) 0x000018B (395)	Microsoft ACPI-Compliant System
 (ISA) 0x000018C (396)	Microsoft ACPI-Compliant System
 (ISA) 0x000018D (397)	Microsoft ACPI-Compliant System
 (ISA) 0x000018E (398)	Microsoft ACPI-Compliant System
 (ISA) 0x000018F (399)	Microsoft ACPI-Compliant System
 (ISA) 0x0000190 (400)	Microsoft ACPI-Compliant System
 (ISA) 0x0000191 (401)	Microsoft ACPI-Compliant System
 (ISA) 0x0000192 (402)	Microsoft ACPI-Compliant System
 (ISA) 0x0000193 (403)	Microsoft ACPI-Compliant System
 (ISA) 0x0000194 (404)	Microsoft ACPI-Compliant System
 (ISA) 0x0000195 (405)	Microsoft ACPI-Compliant System
 (ISA) 0x0000196 (406)	Microsoft ACPI-Compliant System
 (ISA) 0x0000197 (407)	Microsoft ACPI-Compliant System
 (ISA) 0x0000198 (408)	Microsoft ACPI-Compliant System
 (ISA) 0x0000199 (409)	Microsoft ACPI-Compliant System
 (ISA) 0x000019A (410)	Microsoft ACPI-Compliant System
 (ISA) 0x000019B (411)	Microsoft ACPI-Compliant System
 (ISA) 0x000019C (412)	Microsoft ACPI-Compliant System
 (ISA) 0x000019D (413)	Microsoft ACPI-Compliant System
 (ISA) 0x000019E (414)	Microsoft ACPI-Compliant System
 (ISA) 0x000019F (415)	Microsoft ACPI-Compliant System
 (ISA) 0x00001A0 (416)	Microsoft ACPI-Compliant System
 (ISA) 0x00001A1 (417)	Microsoft ACPI-Compliant System
 (ISA) 0x00001A2 (418)	Microsoft ACPI-Compliant System
 (ISA) 0x00001A3 (419)	Microsoft ACPI-Compliant System
 (ISA) 0x00001A4 (420)	Microsoft ACPI-Compliant System
 (ISA) 0x00001A5 (421)	Microsoft ACPI-Compliant System











































 (ISA) 0x000001A5 (421)	Microsoft ACPI-Compliant System
 (ISA) 0x000001A6 (422)	Microsoft ACPI-Compliant System
 (ISA) 0x000001A7 (423)	Microsoft ACPI-Compliant System
 (ISA) 0x000001A8 (424)	Microsoft ACPI-Compliant System
 (ISA) 0x000001A9 (425)	Microsoft ACPI-Compliant System
 (ISA) 0x000001AA (426)	Microsoft ACPI-Compliant System
 (ISA) 0x000001AB (427)	Microsoft ACPI-Compliant System
 (ISA) 0x000001AC (428)	Microsoft ACPI-Compliant System
 (ISA) 0x000001AD (429)	Microsoft ACPI-Compliant System
 (ISA) 0x000001AE (430)	Microsoft ACPI-Compliant System
 (ISA) 0x000001AF (431)	Microsoft ACPI-Compliant System
 (ISA) 0x000001B0 (432)	Microsoft ACPI-Compliant System
 (ISA) 0x000001B1 (433)	Microsoft ACPI-Compliant System
 (ISA) 0x000001B2 (434)	Microsoft ACPI-Compliant System
 (ISA) 0x000001B3 (435)	Microsoft ACPI-Compliant System
 (ISA) 0x000001B4 (436)	Microsoft ACPI-Compliant System
 (ISA) 0x000001B5 (437)	Microsoft ACPI-Compliant System
 (ISA) 0x000001B6 (438)	Microsoft ACPI-Compliant System
 (ISA) 0x000001B7 (439)	Microsoft ACPI-Compliant System
 (ISA) 0x000001B8 (440)	Microsoft ACPI-Compliant System
 (ISA) 0x000001B9 (441)	Microsoft ACPI-Compliant System
 (ISA) 0x000001BA (442)	Microsoft ACPI-Compliant System
 (ISA) 0x000001BB (443)	Microsoft ACPI-Compliant System
 (ISA) 0x000001BC (444)	Microsoft ACPI-Compliant System
 (ISA) 0x000001BD (445)	Microsoft ACPI-Compliant System
 (ISA) 0x000001BE (446)	Microsoft ACPI-Compliant System
 (ISA) 0x000001BF (447)	Microsoft ACPI-Compliant System
 (ISA) 0x000001C0 (448)	Microsoft ACPI-Compliant System
 (ISA) 0x000001C1 (449)	Microsoft ACPI-Compliant System
 (ISA) 0x000001C2 (450)	Microsoft ACPI-Compliant System
 (ISA) 0x000001C3 (451)	Microsoft ACPI-Compliant System
 (ISA) 0x000001C4 (452)	Microsoft ACPI-Compliant System
 (ISA) 0x000001C5 (453)	Microsoft ACPI-Compliant System
 (ISA) 0x000001C6 (454)	Microsoft ACPI-Compliant System
 (ISA) 0x000001C7 (455)	Microsoft ACPI-Compliant System
 (ISA) 0x000001C8 (456)	Microsoft ACPI-Compliant System
 (ISA) 0x000001C9 (457)	Microsoft ACPI-Compliant System
 (ISA) 0x000001CA (458)	Microsoft ACPI-Compliant System
 (ISA) 0x000001CB (459)	Microsoft ACPI-Compliant System
 (ISA) 0x000001CC (460)	Microsoft ACPI-Compliant System
 (ISA) 0x000001CD (461)	Microsoft ACPI-Compliant System
 (ISA) 0x000001CE (462)	Microsoft ACPI-Compliant System

 (ISA) 0x000001CE (462)	Microsoft ACPI-Compliant System
 (ISA) 0x000001CF (463)	Microsoft ACPI-Compliant System
 (ISA) 0x000001D0 (464)	Microsoft ACPI-Compliant System
 (ISA) 0x000001D1 (465)	Microsoft ACPI-Compliant System
 (ISA) 0x000001D2 (466)	Microsoft ACPI-Compliant System
 (ISA) 0x000001D3 (467)	Microsoft ACPI-Compliant System
 (ISA) 0x000001D4 (468)	Microsoft ACPI-Compliant System
 (ISA) 0x000001D5 (469)	Microsoft ACPI-Compliant System
 (ISA) 0x000001D6 (470)	Microsoft ACPI-Compliant System
 (ISA) 0x000001D7 (471)	Microsoft ACPI-Compliant System
 (ISA) 0x000001D8 (472)	Microsoft ACPI-Compliant System
 (ISA) 0x000001D9 (473)	Microsoft ACPI-Compliant System
 (ISA) 0x000001DA (474)	Microsoft ACPI-Compliant System
 (ISA) 0x000001DB (475)	Microsoft ACPI-Compliant System
 (ISA) 0x000001DC (476)	Microsoft ACPI-Compliant System
 (ISA) 0x000001DD (477)	Microsoft ACPI-Compliant System
 (ISA) 0x000001DE (478)	Microsoft ACPI-Compliant System
 (ISA) 0x000001DF (479)	Microsoft ACPI-Compliant System
 (ISA) 0x000001E0 (480)	Microsoft ACPI-Compliant System
 (ISA) 0x000001E1 (481)	Microsoft ACPI-Compliant System
 (ISA) 0x000001E2 (482)	Microsoft ACPI-Compliant System
 (ISA) 0x000001E3 (483)	Microsoft ACPI-Compliant System
 (ISA) 0x000001E4 (484)	Microsoft ACPI-Compliant System
 (ISA) 0x000001E5 (485)	Microsoft ACPI-Compliant System
 (ISA) 0x000001E6 (486)	Microsoft ACPI-Compliant System
 (ISA) 0x000001E7 (487)	Microsoft ACPI-Compliant System
 (ISA) 0x000001E8 (488)	Microsoft ACPI-Compliant System
 (ISA) 0x000001E9 (489)	Microsoft ACPI-Compliant System
 (ISA) 0x000001EA (490)	Microsoft ACPI-Compliant System
 (ISA) 0x000001EB (491)	Microsoft ACPI-Compliant System
 (ISA) 0x000001EC (492)	Microsoft ACPI-Compliant System
 (ISA) 0x000001ED (493)	Microsoft ACPI-Compliant System
 (ISA) 0x000001EE (494)	Microsoft ACPI-Compliant System
 (ISA) 0x000001EF (495)	Microsoft ACPI-Compliant System
 (ISA) 0x000001F0 (496)	Microsoft ACPI-Compliant System
 (ISA) 0x000001F1 (497)	Microsoft ACPI-Compliant System
 (ISA) 0x000001F2 (498)	Microsoft ACPI-Compliant System
 (ISA) 0x000001F3 (499)	Microsoft ACPI-Compliant System
 (ISA) 0x000001F4 (500)	Microsoft ACPI-Compliant System
 (ISA) 0x000001F5 (501)	Microsoft ACPI-Compliant System
 (ISA) 0x000001F6 (502)	Microsoft ACPI-Compliant System
 (ISA) 0x000001F7 (503)	Microsoft ACPI-Compliant System

	(ISA) 0x000001F7 (503)	Microsoft ACPI-Compliant System
	(ISA) 0x000001F8 (504)	Microsoft ACPI-Compliant System
	(ISA) 0x000001F9 (505)	Microsoft ACPI-Compliant System
	(ISA) 0x000001FA (506)	Microsoft ACPI-Compliant System
	(ISA) 0x000001FB (507)	Microsoft ACPI-Compliant System
	(ISA) 0x000001FC (508)	Microsoft ACPI-Compliant System
	(ISA) 0x000001FD (509)	Microsoft ACPI-Compliant System
	(ISA) 0x000001FE (510)	Microsoft ACPI-Compliant System
	(ISA) 0x000001FF (511)	Microsoft ACPI-Compliant System
	(PCI) 0x00000010 (16)	High Definition Audio Controller
	(PCI) 0x00000013 (19)	Intel(R) Active Management Technology - SOL (COM7)
	(PCI) 0xFFFFFDFD (-33)	Intel(R) Management Engine Interface
	(PCI) 0xFFFFFDE0 (-32)	Intel(R) Ethernet Connection (7) I219-LM
	(PCI) 0xFFFFFDE1 (-31)	Intel(R) I211 Gigabit Network Connection #2
	(PCI) 0xFFFFFDE2 (-30)	Intel(R) I211 Gigabit Network Connection #2
	(PCI) 0xFFFFFDE3 (-29)	Intel(R) I211 Gigabit Network Connection #2
	(PCI) 0xFFFFFDE4 (-28)	Intel(R) I211 Gigabit Network Connection #2
	(PCI) 0xFFFFFDE5 (-27)	Intel(R) I211 Gigabit Network Connection #2
	(PCI) 0xFFFFFDE6 (-26)	Intel(R) I211 Gigabit Network Connection #2
	(PCI) 0xFFFFFDE7 (-25)	Intel(R) I211 Gigabit Network Connection #2
	(PCI) 0xFFFFFDE8 (-24)	Intel(R) I211 Gigabit Network Connection #2
	(PCI) 0xFFFFFDE9 (-23)	Intel(R) I211 Gigabit Network Connection #3
	(PCI) 0xFFFFFDEA (-22)	Intel(R) I211 Gigabit Network Connection #3
	(PCI) 0xFFFFFDEB (-21)	Intel(R) I211 Gigabit Network Connection #3
	(PCI) 0xFFFFFDEC (-20)	Intel(R) I211 Gigabit Network Connection #3
	(PCI) 0xFFFFFDED (-19)	Intel(R) I211 Gigabit Network Connection #3
	(PCI) 0xFFFFFDEE (-18)	Intel(R) I211 Gigabit Network Connection #3
	(PCI) 0xFFFFFDEF (-17)	Intel(R) I211 Gigabit Network Connection #3
	(PCI) 0xFFFFFDF0 (-16)	Intel(R) I211 Gigabit Network Connection #3
	(PCI) 0xFFFFFDF1 (-15)	Intel(R) I211 Gigabit Network Connection
	(PCI) 0xFFFFFDF2 (-14)	Intel(R) I211 Gigabit Network Connection
	(PCI) 0xFFFFFDF3 (-13)	Intel(R) I211 Gigabit Network Connection
	(PCI) 0xFFFFFDF4 (-12)	Intel(R) I211 Gigabit Network Connection
	(PCI) 0xFFFFFDF5 (-11)	Intel(R) I211 Gigabit Network Connection
	(PCI) 0xFFFFFDF6 (-10)	Intel(R) I211 Gigabit Network Connection
	(PCI) 0xFFFFFDF7 (-9)	Intel(R) I211 Gigabit Network Connection
	(PCI) 0xFFFFFDF8 (-8)	Intel(R) I211 Gigabit Network Connection
	(PCI) 0xFFFFFDF9 (-7)	Intel(R) USB 3.1 eXtensible Host Controller - 1.10 (Microsoft)
	(PCI) 0xFFFFFDF0 (-6)	Intel(R) UHD Graphics 630
	(PCI) 0xFFFFFDFB (-5)	Intel(R) 300 Series Chipset Family SATA AHCI Controller
	(PCI) 0xFFFFFDFC (-4)	Intel(R) PCI Express Root Port #8 - A33F
	(PCI) 0xFFFFFDFD (-3)	Intel(R) PCI Express Root Port #7 - A33E

-  (PCI) 0xFFFFF7FC (-4) Intel(R) PCI Express Root Port #8 - A33F
-  (PCI) 0xFFFFF7FD (-3) Intel(R) PCI Express Root Port #7 - A33E
-  (PCI) 0xFFFFF7FE (-2) Intel(R) PCI Express Root Port #6 - A33D

B.3 Memory Address Map

Memory	
	[0000000000A0000 - 0000000000BFFFF] PCI Express Root Complex
	[0000000040000000 - 00000000403FFFF] Motherboard resources
	[0000000090000000 - 000000009FFFFFF] Intel(R) UHD Graphics 630
	[0000000090000000 - 00000000DFFFFFF] PCI Express Root Complex
	[00000000A0000000 - 00000000A0FFFFFF] Intel(R) UHD Graphics 630
	[00000000A1100000 - 00000000A11FFFF] Intel(R) I211 Gigabit Network Connection #2
	[00000000A1100000 - 00000000A11FFFF] Intel(R) PCI Express Root Port #8 - A33F
	[00000000A1120000 - 00000000A1123FFF] Intel(R) I211 Gigabit Network Connection #2
	[00000000A1200000 - 00000000A121FFFF] Intel(R) I211 Gigabit Network Connection #3
	[00000000A1200000 - 00000000A12FFFF] Intel(R) PCI Express Root Port #7 - A33E
	[00000000A1220000 - 00000000A1223FFF] Intel(R) I211 Gigabit Network Connection #3
	[00000000A1300000 - 00000000A131FFFF] Intel(R) I211 Gigabit Network Connection
	[00000000A1300000 - 00000000A13FFFF] Intel(R) PCI Express Root Port #6 - A33D
	[00000000A1320000 - 00000000A1323FFF] Intel(R) I211 Gigabit Network Connection
	[00000000A1420000 - 00000000A142FFFF] Intel(R) USB 3.1 eXtensible Host Controller - 1.10 (Microsoft)
	[00000000A1434000 - 00000000A1435FFF] Intel(R) 300 Series Chipset Family SATA AHCI Controller
	[00000000A1438000 - 00000000A14380FF] Intel(R) SMBus - A323
	[00000000A1439000 - 00000000A14397FF] Intel(R) 300 Series Chipset Family SATA AHCI Controller
	[00000000A143A000 - 00000000A143A0FF] Intel(R) 300 Series Chipset Family SATA AHCI Controller
	[00000000E0000000 - 00000000EFFFFFF] Motherboard resources
	[00000000FC800000 - 00000000FE7FFFF] PCI Express Root Complex
	[00000000FCF00000 - 00000000FCFFFFFF] High Definition Audio Controller
	[00000000FD000000 - 00000000FD69FFF] Motherboard resources
	[00000000FD6A0000 - 00000000FD6AFFFF] Intel(R) Serial IO GPIO Host Controller - INT3450
	[00000000FD6B0000 - 00000000FD6BFFFF] Intel(R) Serial IO GPIO Host Controller - INT3450
	[00000000FD6C0000 - 00000000FD6CFFFF] Motherboard resources
	[00000000FD6D0000 - 00000000FD6DFFFF] Intel(R) Serial IO GPIO Host Controller - INT3450
	[00000000FD6E0000 - 00000000FD6EFFFF] Intel(R) Serial IO GPIO Host Controller - INT3450
	[00000000FD6F0000 - 00000000FDFFFFFF] Motherboard resources
	[00000000FE000000 - 00000000FE01FFF] Motherboard resources
	[00000000FE010000 - 00000000FE010FFF] Intel(R) SPI (flash) Controller - A324
	[00000000FE1D8000 - 00000000FE1DBFFF] High Definition Audio Controller
	[00000000FE1DE000 - 00000000FE1DEFFF] Intel(R) Management Engine Interface
	[00000000FE1DF000 - 00000000FE1DFFFF] Intel(R) Active Management Technology - SOL (COM7)
	[00000000FE1E0000 - 00000000FE1FFFF] Intel(R) Ethernet Connection (7) I219-LM
	[00000000FE200000 - 00000000FE7FFFF] Motherboard resources
	[00000000FED19000 - 00000000FED19FFF] Motherboard resources
	[00000000FED20000 - 00000000FED3FFFF] Motherboard resources
	[00000000FED40000 - 00000000FED44FFF] Trusted Platform Module 2.0
	[00000000FED45000 - 00000000FED8FFFF] Motherboard resources
	[00000000FED90000 - 00000000FED93FFF] Motherboard resources
	[00000000FEE00000 - 00000000FEEFFFF] Motherboard resources
	[00000000FF000000 - 00000000FFFFFFFF] Motherboard resources

Appendix C

Digital I/O Ports

C.1 Electrical Specifications for Digital I/O Ports

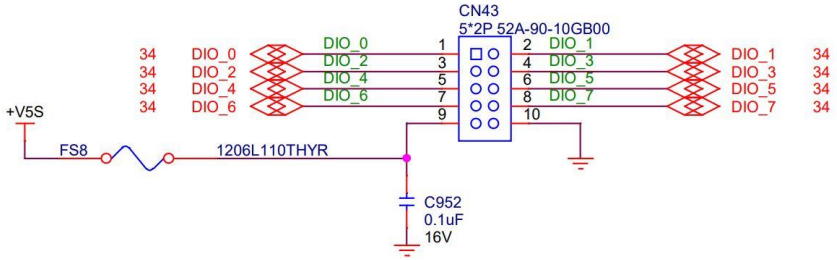

GPIO70	DIO_0
GPIO71	DIO_1
GPIO72	DIO_2
GPIO73	DIO_3
GPIO74	DIO_4
GPIO75	DIO_5
GPIO76	DIO_6
GPIO77	DIO_7

C.2 DIO Programming

BOXER-6839-CFL utilizes FINTEK F81966 chipset as its Digital I/O controller. The following sections detail the procedures to complete its configuration. The AAEON initial DIO program is also attached to help with developing a customized program for your application.

There are three steps to complete the configuration setup:

- Step 1** Enter MB PnP Mode.
- Step 2** Modify the data in the configuration registers.
- Step 3** Exit MB PnP Mode. Undesired results may occur if MB PnP Mode is not exited properly.

C.3 Digital I/O Register

Table 1: SuperIO relative register table

	Default Value	Note
Index	0x2E(Note1)	SIO MB PnP Mode Index Register 0x2E or 0x4E
Data	0x2F(Note2)	SIO MB PnP Mode Data Register 0x2F or 0x4F

Table 2: Digital Input relative register table

	LDN	Register	BitNum	Value	Note
DIO-1 Pin Status	0x06(Note3)	0x82(Note4)	0(Note5)		GPIO70
DIO-2 Pin Status	0x06(Note6)	0x82(Note7)	1(Note8)		GPIO71
DIO-3 Pin Status	0x06(Note9)	0x82(Note10)	2(Note11)		GPIO72
DIO-4 Pin Status	0x06(Note12)	0x82(Note13)	3(Note14)		GPIO73
DIO-5 Pin Status	0x06(Note15)	0x82(Note16)	4(Note17)		GPIO74
DIO-6 Pin Status	0x06(Note18)	0x82(Note19)	5(Note20)		GPIO75
DIO-7 Pin Status	0x06(Note21)	0x82(Note22)	6(Note23)		GPIO76
DIO-8 Pin Status	0x06(Note24)	0x82(Note25)	7(Note26)		GPIO77

Table 3: Digital Output relative register table

	LDN	Register	BitNum	Value	Note
DIO-1 Output Data	0x06(Note27)	0x81(Note28)	0(Note29)	(Note30)	GPIO70
DIO-2 Output Data	0x06(Note31)	0x81(Note32)	1(Note33)	(Note34)	GPIO71
DIO-3 Output Data	0x06(Note35)	0x81(Note36)	2(Note37)	(Note38)	GPIO72
DIO-4 Output Data	0x06(Note39)	0x81(Note40)	3(Note41)	(Note42)	GPIO73
DIO-5 Output Data	0x06(Note43)	0x81(Note44)	4(Note45)	(Note46)	GPIO74
DIO-6 Output Data	0x06(Note47)	0x81(Note48)	5(Note49)	(Note50)	GPIO75
DIO-7 Output Data	0x06(Note51)	0x81(Note52)	6(Note53)	(Note54)	GPIO76
DIO-8 Output Data	0x06(Note55)	0x81(Note56)	7(Note57)	(Note58)	GPIO77

C.4 Digital I/O Sample Program

```
*****
// SuperIO relative definition (Please reference to Table 1)
#define byte SIOIndex //This parameter is represented from Note1
#define byte SIOData //This parameter is represented from Note2
#define void IOWriteByte(byte IOPort, byte Value);
#define byte IOReadByte(byte IOPort);
// Digital Input Status relative definition (Please reference to Table 2)
#define byte DInput1LDN // This parameter is represented from Note3
#define byte DInput1Reg // This parameter is represented from Note4
#define byte DInput1Bit // This parameter is represented from Note5
#define byte DInput2LDN // This parameter is represented from Note6
#define byte DInput2Reg // This parameter is represented from Note7
#define byte DInput2Bit // This parameter is represented from Note8
#define byte DInput3LDN // This parameter is represented from Note9
#define byte DInput3Reg // This parameter is represented from Note10
#define byte DInput3Bit // This parameter is represented from Note11
#define byte DInput4LDN // This parameter is represented from Note12
#define byte DInput4Reg // This parameter is represented from Note13
#define byte DInput4Bit // This parameter is represented from Note14
#define byte DInput5LDN // This parameter is represented from Note15
#define byte DInput5Reg // This parameter is represented from Note16
#define byte DInput5Bit // This parameter is represented from Note17
#define byte DInput6LDN // This parameter is represented from Note18
#define byte DInput6Reg // This parameter is represented from Note19
#define byte DInput6Bit // This parameter is represented from Note20
#define byte DInput7LDN // This parameter is represented from Note21
#define byte DInput7Reg // This parameter is represented from Note22
#define byte DInput7Bit // This parameter is represented from Note23
#define byte DInput8LDN // This parameter is represented from Note24
#define byte DInput8Reg // This parameter is represented from Note25
#define byte DInput8Bit // This parameter is represented from Note26
*****
```

```

*****
// Digital Output control relative definition (Please reference to Table 3)
#define byte DOutput1LDN // This parameter is represented from Note27
#define byte DOutput1Reg // This parameter is represented from Note28
#define byte DOutput1Bit // This parameter is represented from Note29
#define byte DOutput1Val // This parameter is represented from Note30
#define byte DOutput2LDN // This parameter is represented from Note31
#define byte DOutput2Reg // This parameter is represented from Note32
#define byte DOutput2Bit // This parameter is represented from Note33
#define byte DOutput2Val // This parameter is represented from Note34
#define byte DOutput3LDN // This parameter is represented from Note35
#define byte DOutput3Reg // This parameter is represented from Note36
#define byte DOutput3Bit // This parameter is represented from Note37
#define byte DOutput3Val // This parameter is represented from Note38
#define byte DOutput4LDN // This parameter is represented from Note39
#define byte DOutput4Reg // This parameter is represented from Note40
#define byte DOutput4Bit // This parameter is represented from Note41
#define byte DOutput4Val // This parameter is represented from Note42
#define byte DOutput5LDN // This parameter is represented from Note43
#define byte DOutput5Reg // This parameter is represented from Note44
#define byte DOutput5Bit // This parameter is represented from Note45
#define byte DOutput5Val // This parameter is represented from Note46
#define byte DOutput6LDN // This parameter is represented from Note47
#define byte DOutput6Reg // This parameter is represented from Note48
#define byte DOutput6Bit // This parameter is represented from Note49
#define byte DOutput6Val // This parameter is represented from Note50
#define byte DOutput7LDN // This parameter is represented from Note51
#define byte DOutput7Reg // This parameter is represented from Note52
#define byte DOutput7Bit // This parameter is represented from Note53
#define byte DOutput7Val // This parameter is represented from Note54
#define byte DOutput8LDN // This parameter is represented from Note55
#define byte DOutput8Reg // This parameter is represented from Note56
#define byte DOutput8Bit // This parameter is represented from Note57
#define byte DOutput8Val // This parameter is represented from Note58
*****

```

```
*****
VOID Main(){
    Boolean PinStatus ;

    // Procedure : AaeonReadPinStatus
    // Input :
    //     Example, Read Digital I/O Pin 3 status
    // Output :
    //     InputStatus :
    //         0: Digital I/O Pin level is low
    //         1: Digital I/O Pin level is High
    PinStatus = AaeonReadPinStatus(DInput3LDN, DInput3Reg, DInput3Bit);

    // Procedure : AaeonSetOutputLevel
    // Input :
    //     Example, Set Digital I/O Pin 6 level
    AaeonSetOutputLevel(DOutput6LDN, DOutput6Reg, DOutput6Bit,
DOutput6Val);
}
*****
```

```
*****
Boolean  AaeonReadPinStatus(byte LDN, byte Register, byte BitNum){
    Boolean PinStatus ;

    PinStatus = SIOBitRead(LDN, Register, BitNum);
    Return PinStatus ;
}
VOID  AaeonSetOutputLevel(byte LDN, byte Register, byte BitNum, byte Value){
    ConfigToOutputMode(LDN, Register, BitNum);
    SIOBitSet(LDN, Register, BitNum, Value);
}
*****
```

```
*****
VOID  SIOEnterMBPnPMode(){
    IOWriteByte(SIOIndex, 0x87);
    IOWriteByte(SIOIndex, 0x87);
}

VOID  SIOExitMBPnPMode(){
    IOWriteByte(SIOIndex, 0xAA);
}

VOID  SIOSelectLDN(byte LDN){
    IOWriteByte(SIOIndex, 0x07); // SIO LDN Register Offset = 0x07
    IOWriteByte(SIOData, LDN);
}

VOID  SIOBitSet(byte LDN, byte Register, byte BitNum, byte Value){
    Byte TmpValue;

    SIOEnterMBPnPMode();
    SIOSelectLDN(byte LDN);
    IOWriteByte(SIOIndex, Register);
    TmpValue = IOReadByte(SIOData);
    TmpValue &= ~(1 << BitNum);
    TmpValue |= (Value << BitNum);
    IOWriteByte(SIOData, TmpValue);
    SIOExitMBPnPMode();
}

VOID  SIOByteSet(byte LDN, byte Register, byte Value){
    SIOEnterMBPnPMode();
    SIOSelectLDN(LDN);
    IOWriteByte(SIOIndex, Register);
    IOWriteByte(SIOData, Value);
    SIOExitMBPnPMode();
}
*****
```

```

*****
Boolean  SIOBitRead(byte LDN, byte Register, byte BitNum){
    Byte TmpValue;

    SIOEnterMBPnPMode();
    SIOSelectLDN(LDN);
    IOWriteByte(SIOIndex, Register);
    TmpValue = IOReadByte(SIOData);
    TmpValue &= (1 << BitNum);
    SIOExitMBPnPMode();
    If(TmpValue == 0)
        Return 0;
    Return 1;
}
VOID  ConfigToOutputMode(byte LDN, byte Register, byte BitNum){
    Byte TmpValue, OutputEnableReg;

    OutputEnableReg = Register-1;
    SIOEnterMBPnPMode();
    SIOSelectLDN(LDN);
    IOWriteByte(SIOIndex, OutputEnableReg);
    TmpValue = IOReadByte(SIOData);
    TmpValue |= (1 << BitNum);
    IOWriteByte(SIOData, OutputEnableReg);
    SIOExitMBPnPMode();
}
*****

```

Appendix D

Glue Removal Procedure

D.1 Removing Glue from Your System

To protect components from damage and ensure proper operation out of the box, glue may have been applied to some cables or connectors to keep them in place during shipping. This glue must be removed before attempting to swap components or perform maintenance. This section details the steps needed to remove the glue.

Before performing any kind of system maintenance, ensure the system is shut down (not in sleep or hibernate mode) and the power cable has been removed. Follow steps in Chapter 2 to access the components inside.

You will need the following items for this step:

- Cotton or cotton swab
- Anti-static tweezers
- An alcohol solution that is at least 99.5% alcohol (ethanol solution or denatured alcohol). AAeon recommends using an eye dropper or a bottle with a nozzle as in the picture below:



Step 1: Using an eyedropper or bottle as shown above, apply a few drops of alcohol to the glue.

Step 2: Allow the alcohol to soak for 10 seconds, then use a cotton swab or cotton with anti-static tweezers to evenly rub the alcohol over the glue.

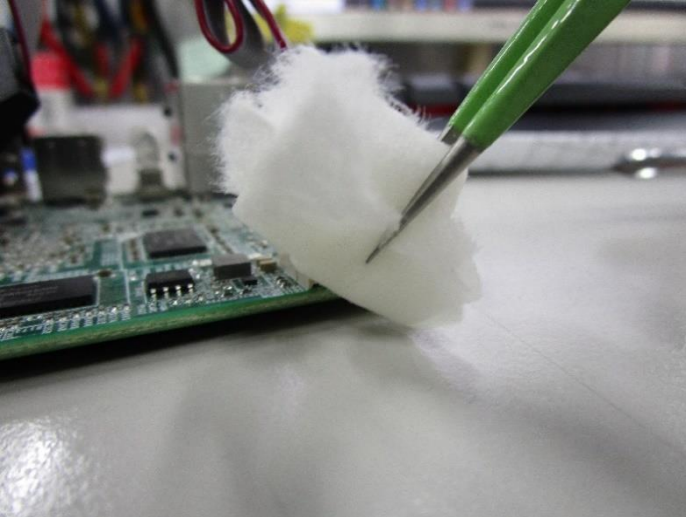

Step 3: Let soak for 10 more seconds, then use anti-static tweezers to remove the glue.

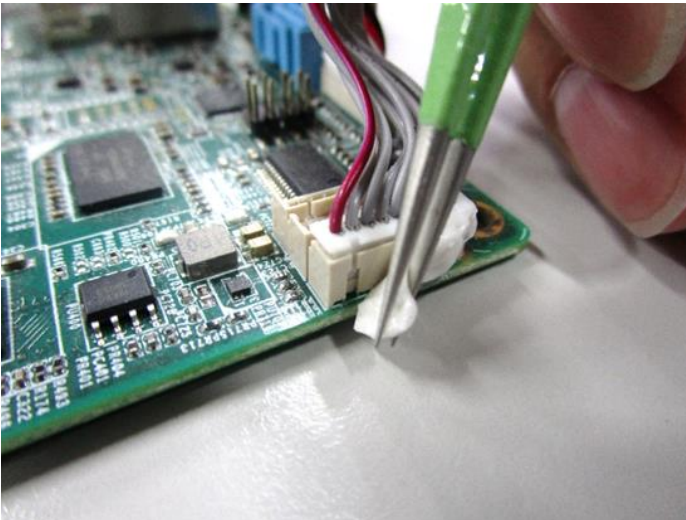

If you encounter any issues or need support, please contact your AAEON representative or visit our [Support Page](#) at AAEON.com