

# BOXER-6641

---

Fanless Embedded Box PC

User's Manual 5<sup>th</sup> Ed

## Copyright Notice

---

This document is copyrighted, 2021. All rights are reserved. The original manufacturer reserves the right to make improvements to the products described in this manual at any time without notice.

No part of this manual may be reproduced, copied, translated, or transmitted in any form or by any means without the prior written permission of the original manufacturer. Information provided in this manual is intended to be accurate and reliable. However, the original manufacturer assumes no responsibility for its use, or for any infringements upon the rights of third parties that may result from its use.

The material in this document is for product information only and is subject to change without notice. While reasonable efforts have been made in the preparation of this document to assure its accuracy, AAEON assumes no liabilities resulting from errors or omissions in this document, or from the use of the information contained herein.

AAEON reserves the right to make changes in the product design without notice to its users.

## Acknowledgement

---

All other product name or trademarks are properties of their respective owners.

- Microsoft Windows® is a registered trademark of Microsoft Corp.
- Intel®, Pentium®, Celeron®, and Xeon® are registered trademarks of Intel Corporation
- Intel Core™ is a trademark of Intel Corporation

All other product names or trademarks are properties of their respective owners. The publisher of this document does not assume nor imply ownership of any trademarked product not listed herein.

## Packing List

---

Before setting up your product, please make sure the following items have been shipped:

Item	Quantity
● BOXER-6641	1
● Wallmount bracket	2
● Screw Package	1
● 3 Pin DC-In Power Connector	1

If any of these items are missing or damaged, please contact your distributor or sales representative immediately.

## About this Document

---

This User's Manual contains all the essential information, such as detailed descriptions and explanations on the product's hardware and software features (if any), its specifications, dimensions, jumper/connector settings/definitions, and driver installation instructions (if any), to facilitate users in setting up their product.

Users may refer to the product page at [AAEON.com](http://AAEON.com) for the latest version of this document.

## Safety Precautions

---

Please read the following safety instructions carefully. It is advised that you keep this manual for future references

1. All cautions and warnings on the device should be noted.
2. Make sure the power source matches the power rating of the device.
3. Position the power cord so that people cannot step on it. Do not place anything over the power cord.
4. Always completely disconnect the power before working on the system's hardware.
5. No connections should be made when the system is powered as a sudden rush of power may damage sensitive electronic components.
6. If the device is not to be used for a long time, disconnect it from the power supply to avoid damage by transient over-voltage.
7. Always disconnect this device from any power supply before cleaning.
8. While cleaning, use a damp cloth instead of liquid or spray detergents.
9. Make sure the device is installed near a power outlet and is easily accessible.
10. Keep this device away from humidity.
11. Place the device on a solid surface during installation to prevent falls.
12. Do not cover the openings on the device to ensure optimal heat dissipation.
13. Watch out for high temperatures when the system is running.
14. Do not touch the heat sink or heat spreader when the system is running
15. Never pour any liquid into the openings. This could cause fire or electric shock.
16. As most electronic components are sensitive to static electrical charge, be sure to ground yourself to prevent static charge when installing the internal components. Use a grounding wrist strap and contain all electronic components in any static-shielded containers.

17. If any of the following situations arises, please the contact our service personnel:
  - i. Damaged power cord or plug
  - ii. Liquid intrusion to the device
  - iii. Exposure to moisture
  - iv. Device is not working as expected or in a manner as described in this manual
  - v. The device is dropped or damaged
  - vi. Any obvious signs of damage displayed on the device
18. Do not leave this device in an uncontrolled environment with temperatures beyond the device's permitted storage temperatures (see chapter 1) to prevent damage.
19. Do NOT disassemble the motherboard so as not to damage the system or void your warranty.
20. If the thermal pad had been damaged, please contact AAEON's salesperson to purchase a new one. Do NOT use those of other brands.
21. The Hex Cylinder Coppers on the front panel are not removable.
22. Repeatedly assemble and disassemble the system may cause damages to the exterior paint and surface and screw holes.
23. Use the right size screwdriver.
24. Use the screwdriver correctly to remove screws from the system.

### **Warning!**



This device complies with Part 15 FCC Rules. Operation is subject to the following two conditions: (1) this device may not cause harmful interference, and (2) this device must accept any interference received including interference that may cause undesired operation.

### **Caution:**

*There is a danger of explosion if the battery is incorrectly replaced. Replace only with the same or equivalent type recommended by the manufacturer. Dispose of used batteries according to the manufacturer's instructions and your local government's recycling or disposal directives.*

### **Attention:**

*Il y a un risque d'explosion si la batterie est remplacée de façon incorrecte. Ne la remplacer qu'avec le même modèle ou équivalent recommandé par le constructeur. Recycler les batteries usées en accord avec les instructions du fabricant et les directives gouvernementales de recyclage.*



## 产品中有毒有害物质或元素名称及含量

AAEON System

QO4-381 Rev.A0

部件名称	有毒有害物质或元素					
	铅 (Pb)	汞 (Hg)	镉 (Cd)	六价铬 (Cr(VI))	多溴联苯 (PBB)	多溴二苯 醚(PBDE)
印刷电路板 及其电子组件	×	○	○	○	○	○
外部信号 连接器及线材	×	○	○	○	○	○
外壳	○	○	○	○	○	○
中央处理器 与内存	×	○	○	○	○	○
硬盘	×	○	○	○	○	○
液晶模块	×	×	○	○	○	○
光驱	×	○	○	○	○	○
触控模块	×	○	○	○	○	○
电源	×	○	○	○	○	○
电池	×	○	○	○	○	○

本表格依据 SJ/T 11364 的规定编制。

○：表示该有毒有害物质在该部件所有均质材料中的含量均在 GB/T 26572 标准规定的限量要求以下。

×：表示该有害物质的某一均质材料超出了 GB/T 26572 的限量要求，然而该部件

仍符合欧盟指令 2011/65/EU 的规范。

备注：

- 一、此产品所标示之环保使用期限，系指在一般正常使用状况下。
- 二、上述部件物质中央处理器、内存、硬盘、光驱、电源为选购品。
- 三、上述部件物质液晶模块、触控模块仅一体机产品适用。

**Hazardous and Toxic Materials List**

AAEON System

QO4-381 Rev.A0

Component Name	Hazardous or Toxic Materials or Elements					
	Lead (Pb)	Mercury (Hg)	Cadmium (Cd)	Hexavalent Chromium (Cr(VI))	Polybrominated biphenyls (PBBS)	Polybrominated diphenyl ethers (PBDES)
PCB and Components	X	O	O	O	O	O
Wires & Connectors for Ext.Connections	X	O	O	O	O	O
Chassis	O	O	O	O	O	O
CPU & RAM	X	O	O	O	O	O
HDD Drive	X	O	O	O	O	O
LCD Module	X	X	O	O	O	O
Optical Drive	X	O	O	O	O	O
Touch Control Module	X	O	O	O	O	O
PSU	X	O	O	O	O	O
Battery	X	O	O	O	O	O

This form is prepared in compliance with the provisions of SJ/T 11364.

O: The level of toxic or hazardous materials present in this component and its parts is below the limit specified by GB/T 26572.

X: The level of toxic of hazardous materials present in the component exceed the limits specified by GB/T 26572, but is still in compliance with EU Directive 2011/65/EU (RoHS 2).

Notes:

1. The Environment Friendly Use Period indicated by labelling on this product is applicable only to use under normal conditions.
2. Individual components including the CPU, RAM/memory, HDD, optical drive, and PSU are optional.
3. LCD Module and Touch Control Module only applies to certain products which feature these components.

# Table of Contents

---

<b>Chapter 1 - Product Specifications .....</b>	<b>1</b>
1.1 Specifications.....	2
<b>Chapter 2 – Hardware Information .....</b>	<b>4</b>
2.1 BOXER-6641 Dimensions.....	5
2.2 Jumpers and Connectors .....	9
2.3 List of Jumpers .....	11
2.3.1 Setting Jumpers.....	11
2.3.2 ATX/ AT Mode Selection (JP19) .....	12
2.3.3 CMOS Control Selection (JP24) .....	12
2.4 List of Connectors .....	13
2.4.1 HDMI Port (CN75) .....	15
2.4.2 HDMI Port (CN76) .....	16
2.4.3 COM Port 1 (Wafer Box, Optional) (CN59) .....	17
2.4.4 COM Port 2 (Wafer Box, Optional) (CN57) .....	18
2.4.5 COM Port 3 (Wafer Box, Optional) (CN61) .....	19
2.4.6 COM Port 4 (Wafer Box, Optional) (CN55) .....	20
2.4.7 COM Port 5 (Wafer Box, Optional) (CN48) .....	21
2.4.8 COM Port 6 (Wafer Box, Optional) (CN50) .....	22
2.4.9 COM1 + COM2 Connector RS232/RS422/RS485 (CN60).....	23
2.4.10 COM3 + COM4 Connector RS232/RS422/RS485 (CN62).....	24
2.4.11 COM5 + COM6 Connector RS232/RS422/RS485 (CN49).....	25
2.4.12 Mini-Card Slot (Full Mini-Card) (PCIE1) .....	26
2.4.13 Mini-Card Slot (Full Mini-Card) (PCIE2).....	28
2.4.14 Digital IO Port (CN43).....	31
2.4.15 LPC Port (LPC1) .....	32
2.4.16 Audio I/O Port (10P Pitch: 1.25mm) (CN17).....	33

2.4.17	Audio Connector (CN18).....	34
2.4.18	SPI Flash Port (CN7) .....	35
2.4.19	SATA Port (SATA 1,2,3,4).....	35
2.4.20	USB2.0 Wafer BOX (5P Pitch: 1.25mm) (CN 45,71,72).....	36
2.4.21	SATA PWR (PWR 1,2,3,4) .....	36
2.4.22	DC-IN Connector (CN23).....	37
2.4.23	LAN (RJ-45) + Dual USB3.2 Gen 1 (CN74) .....	37
2.4.24	LAN (RJ-45) + Dual USB3.2 Gen 1 (CN73) .....	39
2.4.25	LAN (RJ-45) + Dual USB3.2 Gen 1 (CN15).....	41
2.4.26	LAN (RJ-45) + Dual USB3.2 Gen 1 (CN14).....	42
2.4.27	PCIe [x4] Slot (CN8).....	44
2.4.28	SIM Slot (SIM1).....	47
2.5	CPU Installation.....	48
2.6	Memory RAM Module Installation .....	50
2.7	2.5" SATA Drive Installation.....	52
2.8	Power Connector Installation.....	55
<b>Chapter 3 - AMI BIOS Setup.....</b>		<b>56</b>
3.1	System Test and Initialization .....	57
3.2	AMI BIOS Setup.....	58
3.3	Setup Submenu: Main.....	59
3.4	Setup Submenu: Advanced .....	60
3.4.1	Advanced: Trusted Computing .....	61
3.4.2	Advanced: CPU Configuration.....	63
3.4.3	Advanced: PCH-FW Configuration.....	65
3.4.3.1	Firmware Update Configuration .....	66
3.4.3.2	PTT Configuration .....	67
3.4.4	Advanced: SATA Configuration.....	68
3.4.5	Advanced: USB Configuration .....	69

3.4.6	Advanced: Hardware Monitor.....	70
3.4.7	Advanced: SIO Configuration .....	71
3.4.7.1	Serial Port 1 Configuration .....	72
3.4.7.2	Serial Port 2 Configuration .....	73
3.4.7.3	Serial Port 3 Configuration .....	74
3.4.7.4	Serial Port 4 Configuration .....	75
3.4.7.5	Serial Port 5 Configuration .....	76
3.4.7.6	Serial Port 6 Configuration .....	77
3.4.8	Advanced: Network Stack Configuration .....	78
3.4.9	Advanced: Digital IO Port Configuration.....	81
3.4.10	Advanced: Power Management.....	82
3.5	Setup submenu: Chipset.....	84
3.5.1	Chipset: System Agent (SA) Configuration .....	85
3.5.2	Chipset: PCH-IO Configuration .....	87
3.6	Setup submenu: Security.....	89
3.6.1	Security: Secure Boot.....	90
3.6.1.1	Key Management.....	91
3.7	Setup submenu: Boot.....	95
3.8	Setup submenu: Save & Exit.....	96
<b>Chapter 4 – Drivers Installation .....</b>		<b>97</b>
4.1	Drivers Download and Installation.....	98
<b>Appendix A - Watchdog Timer Programming.....</b>		<b>100</b>
A.1	Watchdog Timer Initial Program.....	101
<b>Appendix B - I/O Information.....</b>		<b>106</b>
B.1	I/O Address Map.....	107
B.2	IRQ Mapping Chart .....	109
<b>Appendix C - Digital I/O Ports.....</b>		<b>110</b>
C.1	Electrical Specifications for Digital I/O Ports .....	111

C.2	DIO Programming .....	112
C.2	Digital I/O Register.....	113
C.3	Digital I/O Sample Program.....	115

# Chapter 1

---

Product Specifications

## 1.1 Specifications

---

### System

<b>CPU</b>	Intel® Xeon® E-2124G (A2 & A6 models only) Intel® i9-9900T Intel® i7-9700TE Intel® i7-8700T Intel® i5-8500T Intel® i3-8100T Pentium® G5400T Celeron® G4900T
<b>Chipset</b>	Intel® C246/H310
<b>System Memory</b>	DDR4-2666 SO-DIMM slot x 2, Up to 64GB, ECC or Non-ECC Supported
<b>Display Interface</b>	HDMI x 2
<b>Storage Device</b>	2.5" SATA HDD/SSD Bay x 1 (A1, A5) 2.5" SATA HDD/SSD Bay x 2 (A2, A6)
<b>Ethernet</b>	Intel® i211 x 3, i219 x 1
<b>I/O</b>	HDMI x 2 RJ-45 x 4 for GbE LAN (i211 x 3, i219 x 1) USB3.2 Gen 1 x 4, USB2.0 x 4 (A1, A5 model) USB 3.2 Gen 1 x 8 (A2, A6 model) DB-9 x 6 for RS-232/422/485 Audio x 1 (MIC-in, Line-out) 3-pin 10~35V Power Input x 1 Power Button x 1 Remote Power switch x 1 Reset Button x 1 HDD LED x 1 SYS LED x 1
<b>Expansion</b>	Full-size Mini PCIe x 1 Full-size Mini Card x 1 (PCIe/mSATA switch by BIOS, Default: mSATA) SIM slot x 1



## System

Indicator	HDD LED x 1 SYS LED x 1
OS Support	Windows® 10 64-bit Linux Ubuntu 18.04

## Power Supply

Power Requirement	3-pin DC Input 10~35V
-------------------	-----------------------

## Mechanical

Mounting	Wall mount
Dimensions (W x H x D)	10.4" x 3.19" x 6.15" (264.2mm x 80.92mm x 156.2mm)
Gross Weight	10.4 lbs. (4.7 kg)
Net Weight	8.2 lbs. (3.7 kg)

## Environmental

Operating Temperature	-4°F ~ 131°F (-20°C ~ 55°C) with 0.5 m/s airflow – with TDP ≤ 35W CPU -4°F ~ 113°F (-20°C ~ 45°C) with 0.5 m/s airflow – with TDP >35W CPU
Storage Temperature	-40°F ~ 176°F (-40°C ~ 80°C)
Storage Humidity	5 ~ 95% at 40°C, non-condensing
Anti-Vibration	2 Grms/ 5 ~ 500Hz/ operation – SSD/mSATA 1 Grms/ 5 ~ 500Hz/ operation – HDD
Certification	CE/FCC class A

# Chapter 2

---

Hardware Information

## 2.1 BOXER-6641 Dimensions

### BOXER-6641-A1/A5 (H310 Chipset)

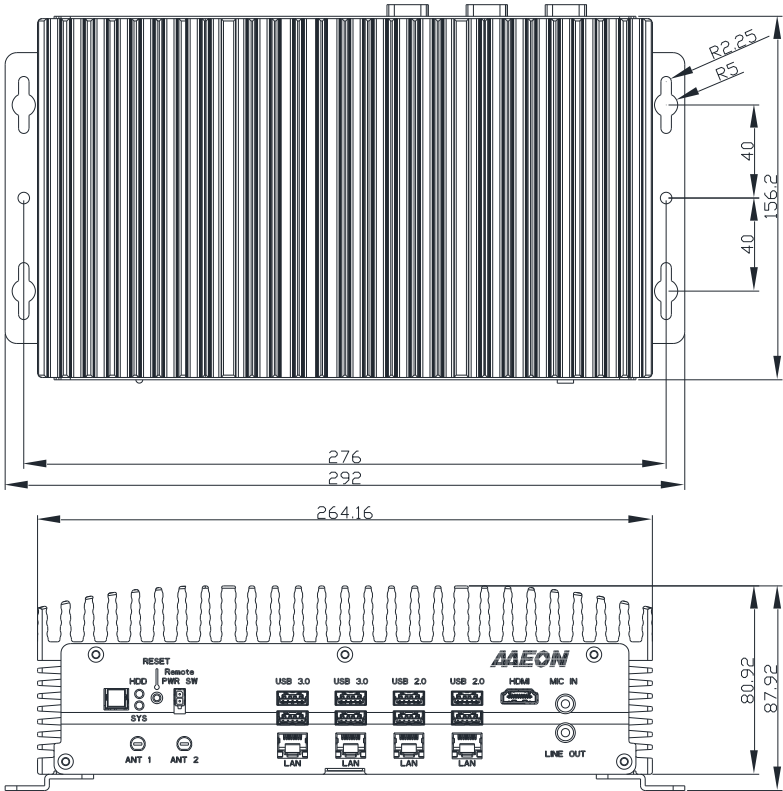

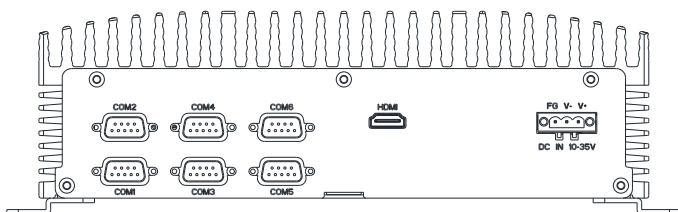

# BOXER-6641-A2/A6 (C246 Chipset)

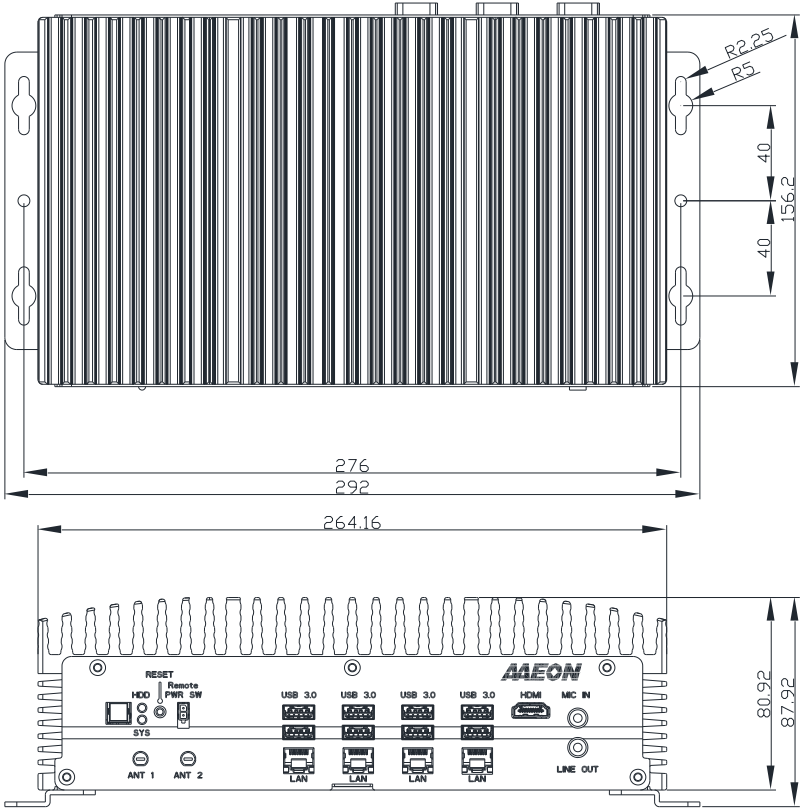

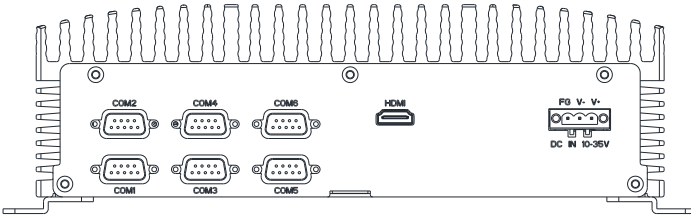

## 2.2 Jumpers and Connectors

**Note:** Board dimensions are 225mm x 151.5mm x 1.8mm

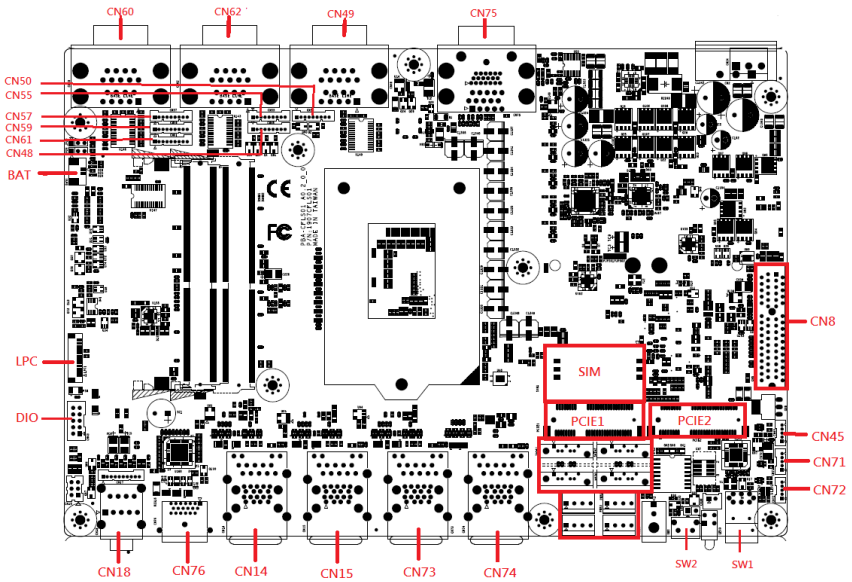

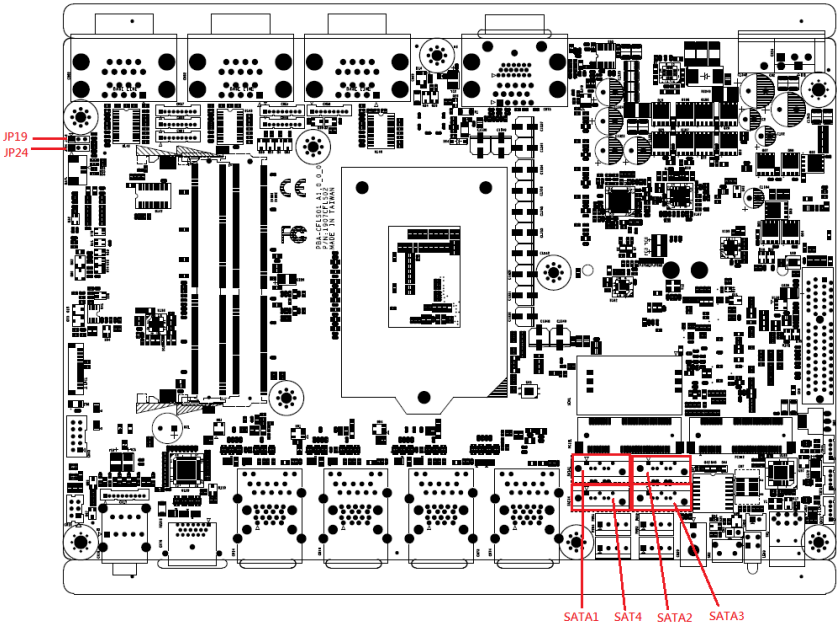



## 2.3 List of Jumpers

Please refer to the table below for all of the system's jumpers that you can configure for your application.

Label	Function
JP19	ATX/AT Mode Selection
JP24	CMOS Control Selection (Clear CMOS)

### 2.3.1 Setting Jumpers

The BOXER-6641 comes with several jumpers which allow you to configure the system by either setting the jumper to "open" or "closed"; or by selecting certain pins. A closed jumper has two pins connected with a jumper clip, while an open jumper has no pins connected.

For jumpers with multiple pins, this guide uses "pins A-B" to notate which pins should be connected by a jumper clip. For example, "pins 1-2" means you should connect pins 1 and 2, while "pins 2-3" means you should connect pins 2 and 3.

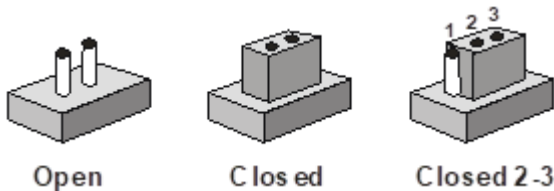

A pair of needle-nose pliers may be helpful when working with jumpers.

If you have any questions about how best to configure the system for your application, contact your AAEON representative or visit our website to talk with our support team.

### 2.3.2 ATX/ AT Mode Selection (JP19)

---

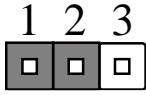

ATX (default)

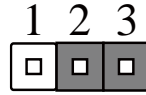

AT

**Note:** Disable Auto Power Button JP19 (1-2) requires user to use power button JP19 (1-2) to power on the system.

### 2.3.3 CMOS Control Selection (JP24)

---

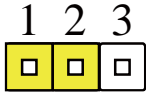

Normal (Default)

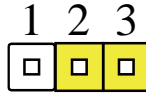

Clear CMOS

## 2.4 List of Connectors

Please refer to the table below for all of the system's connectors that you can configure for your application

Label	Function
BAT1	RTC Battery
CN7	SPI flash port
CN8	PCIE [x4] Slot
CN14	LAN+USB3.2 Gen 1 x2 Connector
CN15	LAN+USB3.2 Gen 1 x2 Connector
CN17	Audio Wafer
CN18	Audio Connector
CN20	Remote Button
CN23	Phoenix Connector Power Input
CN43	DIO (Wafer Box)
CN45	USB2.0 (HEADER)
CN48	COM5 HEADER RS232/RS422/RS485
CN49	COM5+COM6 Connector RS232/RS422/RS485
CN50	COM6 HEADER RS232/RS422/RS485
CN55	COM4 HEADER RS232/RS422/RS485
CN57	COM2 HEADER RS232/RS422/RS485
CN59	COM1 HEADER RS232/RS422/RS485
CN60	COM1+COM2 Connector RS232/RS422/RS485
CN61	COM3 HEADER RS232/RS422/RS485
CN62	COM3+COM4 Connector RS232/RS422/RS485
CN71	USB2.0 (HEADER)
CN72	USB2.0 (HEADER)
CN73	LAN+USB3.2 Gen 1 x2 Connector (USB2.0x2 for H310 Chipset)

Label	Function
CN74	LAN+USB3.2 Gen 1 x2 Connector (USB2.0x2 for H310 Chipset)
CN75	HDMI Port
CN76	HDMI Port
LPC1	LPC Port
PCIE1	Mini-PCIE slot
PCIE2	Mini-PCIE slot
PWR1	SATA PWR Connector
PWR2	SATA PWR Connector
PWR3	SATA PWR Connector
PWR4	SATA PWR Connector
SATA1	SATA1
SATA2	SATA2
SATA3	SATA3
SATA4	SATA4
SIM1	SIM Card Slot
SW1	Power Button
SW2	Reset Switch

## 2.4.1 HDMI Port (CN75)

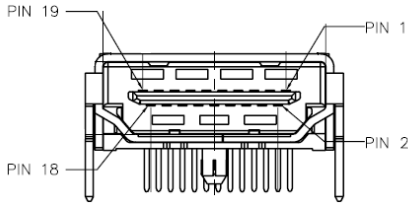

Pin	Signal	Signal Type	Signal Level
1	HDMI2_DATA2_P	DIFF	
2	GND		
3	HDMI2_DATA2_N	DIFF	
4	HDMI2_DATA1_P	DIFF	
5	GND		
6	HDMI2_DATA1_N	DIFF	
7	HDMI2_DATA0_P	DIFF	
8	GND		
9	HDMI2_DATA0_N	DIFF	
10	HDMI2_CLK_P	DIFF	
11	GND	GND	
12	HDMI2_CLK_N	I/O	
13	NC	I/O	
14	NC		
15	SCL	I/O	
16	SDA	I/O	
17	GND	GND	
18	PWR	PWR	5V
19	HPD	I/O	

## 2.4.2 HDMI Port (CN76)

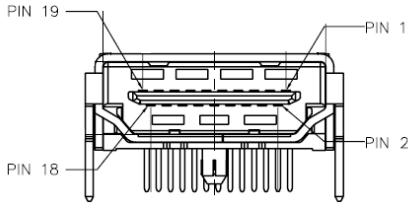

Pin	Signal	Signal Type	Signal Level
1	HDMI2_DATA2_P	DIFF	
2	GND		
3	HDMI2_DATA2_N	DIFF	
4	HDMI2_DATA1_P	DIFF	
5	GND		
6	HDMI2_DATA1_N	DIFF	
7	HDMI2_DATA0_P	DIFF	
8	GND		
9	HDMI2_DATA0_N	DIFF	
10	HDMI2_CLK_P	DIFF	
11	GND	GND	
12	HDMI2_CLK_N	I/O	
13	NC	I/O	
14	NC		
15	SCL	I/O	
16	SDA	I/O	
17	GND	GND	
18	PWR	PWR	5V
19	HPD	I/O	

### 2.4.3 COM Port 1 (Wafer Box, Optional) (CN59)

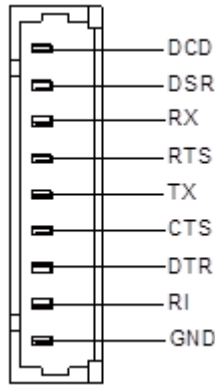

Pin	Signal	Signal Type	Signal Level
1	DCD1	IN	
2	DSR1	IN	
3	RX1	IN	
4	RTS1	OUT	±9V
5	TX1	OUT	±9V
6	CTS1	IN	
7	DTR1	OUT	±9V
8	RI1	IN	
9	GND	GND	

## 2.4.4 COM Port 2 (Wafer Box, Optional) (CN57)

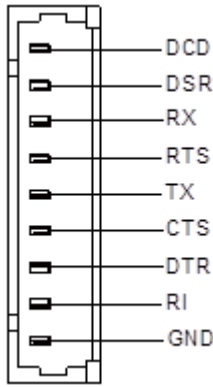

Pin	Signal	Signal Type	Signal Level
1	DCD2	IN	
2	DSR2	IN	
3	RX2	IN	
4	RTS2	OUT	±9V
5	TX2	OUT	±9V
6	CTS2	IN	
7	DTR2	OUT	±9V
8	RI2	IN	
9	GND	GND	



## 2.4.5 COM Port 3 (Wafer Box, Optional) (CN61)

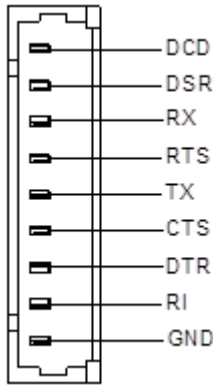

Pin	Signal	Signal Type	Signal Level
1	DCD3	IN	
2	DSR3	IN	
3	RX3	IN	
4	RTS3	OUT	±9V
5	TX3	OUT	±9V
6	CTS3	IN	
7	DTR3	OUT	±9V
8	RI3	IN	
9	GND	GND	

## 2.4.6 COM Port 4 (Wafer Box, Optional) (CN55)

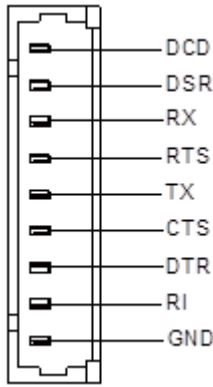

Pin	Signal	Signal Type	Signal Level
1	DCD4	IN	
2	DSR4	IN	
3	RX4	IN	
4	RTS4	OUT	±9V
5	TX4	OUT	±9V
6	CTS4	IN	
7	DTR4	OUT	±9V
8	RI4	IN	
9	GND	GND	

## 2.4.7 COM Port 5 (Wafer Box, Optional) (CN48)

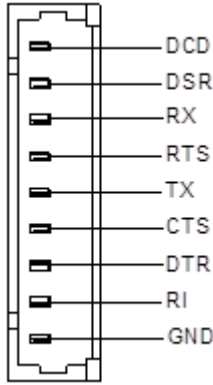

Pin	Signal	Signal Type	Signal Level
1	DCD5	IN	
2	DSR5	IN	
3	RX5	IN	
4	RTS5	OUT	±9V
5	TX5	OUT	±9V
6	CTS5	IN	
7	DTR5	OUT	±9V
8	RI5	IN	
9	GND	GND	

## 2.4.8 COM Port 6 (Wafer Box, Optional) (CN50)

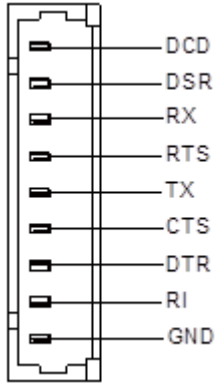

Pin	Signal	Signal Type	Signal Level
1	DCD6	IN	
2	DSR6	IN	
3	RX6	IN	
4	RTS6	OUT	±9V
5	TX6	OUT	±9V
6	CTS6	IN	
7	DTR6	OUT	±9V
8	RI6	IN	
9	GND	GND	

## 2.4.9 COM1 + COM2 Connector RS232/RS422/RS485 (CN60)

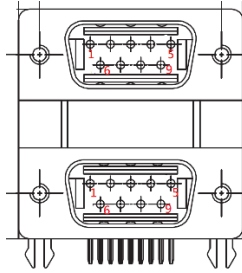

Pin	RS232	RS422	RS485
<b>Top Port</b>			
1	DCD	TX-	D-
2	RX	TX+	D+
3	TX	RX+	NC
4	DTR	RX-	NC
5	GND	NC	NC
6	DSR	NC	NC
7	RTS	NC	NC
8	CTS	NC	NC
9	RI	NC	NC
<b>Bottom Port</b>			
1	DCD	TX-	D-
2	RX	TX+	D+
3	TX	RX+	NC
4	DTR	RX-	NC
5	GND	NC	NC
6	DSR	NC	NC
7	RTS	NC	NC
8	CTS	NC	NC
9	RI	NC	NC

## 2.4.10 COM3 + COM4 Connector RS232/RS422/RS485 (CN62)

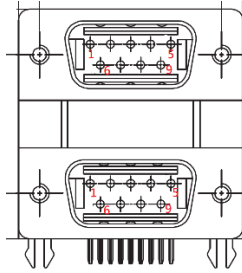

Pin	RS232	RS422	RS485
<b>Top Port</b>			
1	DCD	TX-	D-
2	RX	TX+	D+
3	TX	RX+	NC
4	DTR	RX-	NC
5	GND	NC	NC
6	DSR	NC	NC
7	RTS	NC	NC
8	CTS	NC	NC
9	RI	NC	NC
<b>Bottom Port</b>			
1	DCD	TX-	D-
2	RX	TX+	D+
3	TX	RX+	NC
4	DTR	RX-	NC
5	GND	NC	NC
6	DSR	NC	NC
7	RTS	NC	NC
8	CTS	NC	NC
9	RI	NC	NC

## 2.4.11 COM5 + COM6 Connector RS232/RS422/RS485 (CN49)

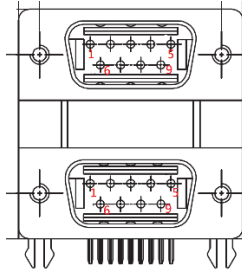

Pin	RS232	RS422	RS485
<b>Top Port</b>			
1	DCD	TX-	D-
2	RX	TX+	D+
3	TX	RX+	NC
4	DTR	RX-	NC
5	GND	NC	NC
6	DSR	NC	NC
7	RTS	NC	NC
8	CTS	NC	NC
9	RI	NC	NC
<b>Bottom Port</b>			
1	DCD	TX-	D-
2	RX	TX+	D+
3	TX	RX+	NC
4	DTR	RX-	NC
5	GND	NC	NC
6	DSR	NC	NC
7	RTS	NC	NC
8	CTS	NC	NC
9	RI	NC	NC

## 2.4.12 Mini-Card Slot (Full Mini-Card) (PCIE1)

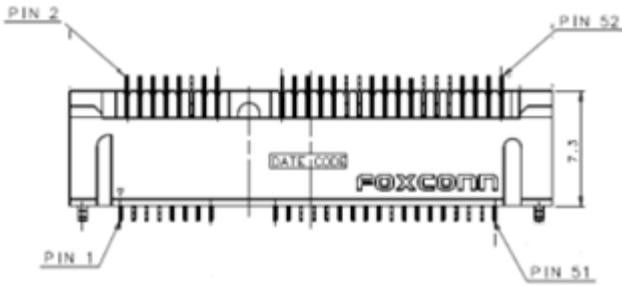

Pin	Signal	Signal Type	Signal Level
1	PCIE_WAKE#	IN	
2	+3.3V	PWR	+3.3V
3	NC		
4	GND	GND	
5	NC		
6	+1.5V	PWR	+1.5V
7	PCIE_CLK_REQ#	IN	
8	NC	PWR	
9	GND	GND	
10	NC	I/O	
11	PCIE_REF_CLK-	DIFF	
12	NC	IN	
13	PCIE_REF_CLK+	DIFF	
14	NC	IN	
15	GND	GND	
16	NC	PWR	
17	NC		



Pin	Signal	Signal Type	Signal Level
18	GND	GND	
19	NC		
20	W_DISABLE#	OUT	+3.3V
21	GND	GND	
22	PCIE_RST#	OUT	+3.3V
23	PCIE_RX-	DIFF	
24	+3.3VSB	PWR	+3.3V
25	PCIE_RX+	DIFF	
26	GND	GND	
27	GND	GND	
28	+1.5V	PWR	+1.5V
29	GND	GND	
30	SMB_CLK	I/O	+3.3V
31	PCIE_TX-	DIFF	
32	SMB_DATA	I/O	+3.3V
33	PCIE_TX+	DIFF	
34	GND	GND	
35	GND	GND	
36	USB_D-	DIFF	
37	GND	GND	
38	USB_D+	DIFF	
39	+3.3VSB	PWR	+3.3V
40	GND	GND	
41	+3.3VSB	PWR	+3.3V
42	NC		
43	GND	GND	

Pin	Signal	Signal Type	Signal Level
44	NC		
45	NC		
46	NC		
47	NC		
48	+1.5V	PWR	+1.5V
49	NC		
50	GND	GND	
51	NC		
52	+3.3VSB	PWR	+3.3V

### 2.4.13 Mini-Card Slot (Full Mini-Card) (PCIe2)

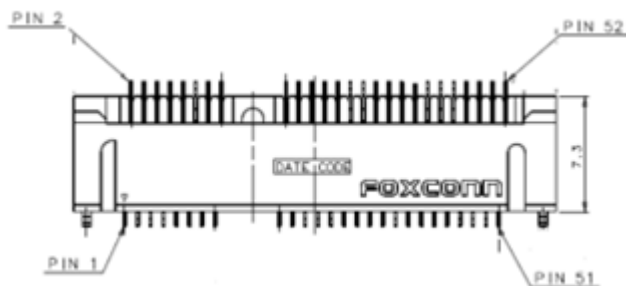

Pin	Signal	Signal Type	Signal Level
1	PCIE_WAKE#	IN	
2	+3.3V	PWR	+3.3V
3	NC		
4	GND	GND	
5	NC		
6	+1.5V	PWR	+1.5V
7	PCIE_CLK_REQ#	IN	

Pin	Signal	Signal Type	Signal Level
8	NC	PWR	
9	GND	GND	
10	NC	I/O	
11	PCIE_REF_CLK-	DIFF	
12	NC	IN	
13	PCIE_REF_CLK+	DIFF	
14	NC	IN	
15	GND	GND	
16	NC	PWR	
17	NC		
18	GND	GND	
19	NC		
20	W_DISABLE#	OUT	+3.3V
21	GND	GND	
22	PCIE_RST#	OUT	+3.3V
23	PCIE_RX-	DIFF	
24	+3.3VSB	PWR	+3.3V
25	PCIE_RX+	DIFF	
26	GND	GND	
27	GND	GND	
28	+1.5V	PWR	+1.5V
29	GND	GND	
30	SMB_CLK	I/O	+3.3V
31	PCIE_TX-	DIFF	
32	SMB_DATA	I/O	+3.3V
33	PCIE_TX+	DIFF	

Pin	Signal	Signal Type	Signal Level
34	GND	GND	
35	GND	GND	
36	USB_D-	DIFF	
37	GND	GND	
38	USB_D+	DIFF	
39	+3.3VSB	PWR	+3.3V
40	GND	GND	
41	+3.3VSB	PWR	+3.3V
42	NC		
43	GND	GND	
44	NC		
45	NC		
46	NC		
47	NC		
48	+1.5V	PWR	+1.5V
49	NC		
50	GND	GND	
51	NC		
52	+3.3VSB	PWR	+3.3V

## 2.4.14 Digital IO Port (CN43)

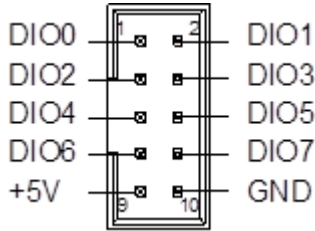

Pin	Signal	Signal Type	Signal Level
1	DIO0	I/O	+5V
2	DIO1	I/O	+5V
3	DIO2	I/O	+5V
4	DIO3	I/O	+5V
5	DIO4	I/O	+5V
6	DIO5	I/O	+5V
7	DIO6	I/O	+5V
8	DIO7	I/O	+5V
9	+5V	PWR	+5V
10	GND	GND	

## 2.4.15 LPC Port (LPC1)

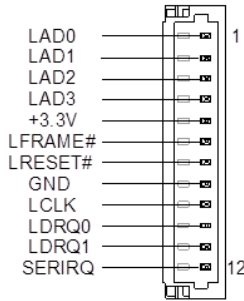

Pin	Signal	Signal Type	Signal Level
1	LAD0	I/O	+3.3V
2	LAD1	I/O	+3.3V
3	LAD2	I/O	+3.3V
4	LAD3	I/O	+3.3V
5	+3.3V	PWR	+3.3V
6	LFRAME#	IN	
7	LRESET#	OUT	+3.3V
8	GND	GND	
9	LCLK	OUT	
10	LDRQ0	IN	
11	LDRQ1	IN	
12	SERIRQ	I/O	+3.3V

## 2.4.16 Audio I/O Port (10P Pitch: 1.25mm) (CN17)

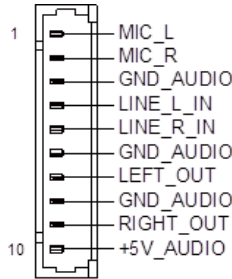

Pin	Signal	Signal Type	Signal Level
1	MIC_L	IN	
2	MIC_R	IN	
3	GND_AUDIO	GND	
4	LINE_L_IN	IN	
5	LINE_R_IN	IN	
6	GND_AUDIO	GND	
7	LEFT_OUT	OUT	
8	GND_AUDIO	GND	
9	RIGHT_OUT	OUT	
10	+5V_AUDIO	PWR	+5V

## 2.4.17 Audio Connector (CN18)

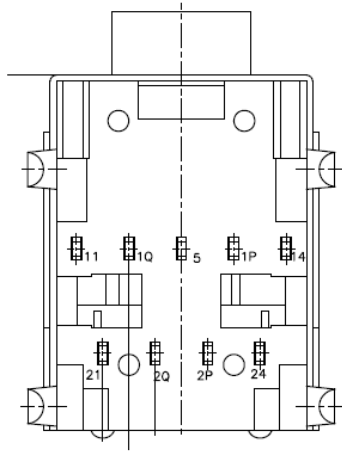

Pin	Signal	Signal Type	Signal Level
5	AUD_GND	GND	
24	LOUT_L	OUT	
21	LOUT_R	OUT	
2P	HP_DET_3	IN	
2Q	HP_DET_4	IN	
14	MIC_L	IN	
11	MIC_R	IN	
1P	HP_DET_1	IN	
1Q	HP_DET2	IN	



## 2.4.18 SPI Flash Port (CN7)

Pin	Signal	Signal Type	Signal Level
1	SPI_MISO	OUT	
2	GND	GND	
3	SPI_CLK	IN	
4	+3.3VSB	PWR	+3.3V
5	SPI_MOSI	IN	
6	SPI_CS	IN	
7	NC		
8	NC		

## 2.4.19 SATA Port (SATA 1,2,3,4)

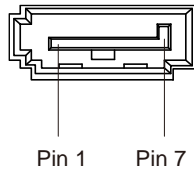

Pin	Signal	Signal Type	Signal Level
1	GND	GND	
2	SATA_TX+	DIFF	
3	SATA_TX-	DIFF	
4	GND	GND	
5	SATA_RX-	DIFF	
6	SATA_RX+	DIFF	
7	GND	GND	

## 2.4.20 USB2.0 Wafer BOX (5P Pitch: 1.25mm) (CN 45,71,72)

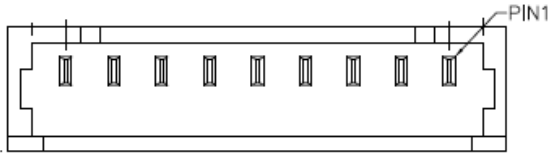

Pin	Signal	Signal Type	Signal Level
1	+5V	GND	+5V
2	USBD-	DIFF	
3	USBD+	DIFF	
4	GND	GND	
5	GND	GND	

## 2.4.21 SATA PWR (PWR 1,2,3,4)

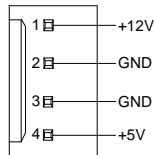

Pin	Signal	Signal Type	Signal Level
1	+12V	PWR	+12V
2	GND	GND	
3	GND	GND	
4	+5V	PWR	+5V

## 2.4.22 DC-IN Connector (CN23)

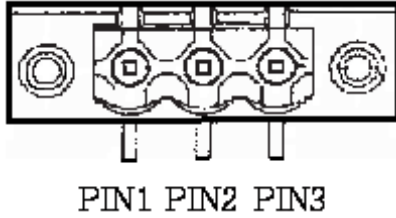

Pin	Signal	Signal Type	Signal Level
1	VIN	PWR	+10V~+35V
2	GND	GND	
3	GND_EARTH		

## 2.4.23 LAN (RJ-45) + Dual USB3.2 Gen 1 (CN74)

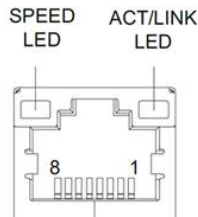

Pin	Signal	Signal Type	Signal Level
1	MDIO+	DIFF	
2	MDIO-	DIFF	
3	MDI1+	DIFF	
4	MDI2+	DIFF	
5	MDI2-	DIFF	
6	MDI1-	DIFF	

Pin	Signal	Signal Type	Signal Level
7	MDI3+	DIFF	
8	MDI3-	DIFF	

**Note:** USB2.0x2 for H310 Chipset

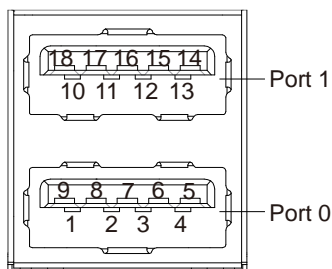

Pin	Signal	Signal Type	Signal Level
1	+5VSB	PWR	+5V
2	USB1_D-	DIFF	
3	USB1_D+	DIFF	
4	GND	GND	
5	USB1_SSRX-	DIFF	
6	USB1_SSRX+	DIFF	
7	GND	GND	
8	USB1_SSTX-	DIFF	
9	USB1_SSTX+	DIFF	
10	+5VSB	PWR	+5V
11	USB2_D-	DIFF	
12	USB2_D+	DIFF	
13	GND	GND	
14	USB2_SSRX-	DIFF	

Pin	Signal	Signal Type	Signal Level
15	USB2_SSRX+	DIFF	
16	GND	GND	
17	USB2_SSTX-	DIFF	
18	USB2_SSTX+	DIFF	

## 2.4.24 LAN (RJ-45) + Dual USB3.2 Gen 1 (CN73)

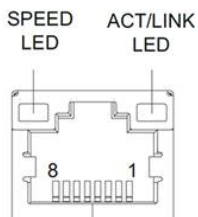

Pin	Signal	Signal Type	Signal Level
1	MDI0+	DIFF	
2	MDI0-	DIFF	
3	MDI1+	DIFF	
4	MDI2+	DIFF	
5	MDI2-	DIFF	
6	MDI1-	DIFF	
7	MDI3+	DIFF	
8	MDI3-	DIFF	

**Note:** USB2.0x2 for H310 Chipset

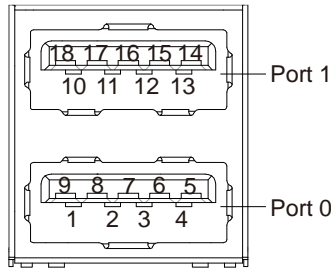

Pin	Signal	Signal Type	Signal Level
1	+5VSB	PWR	+5V
2	USB3_D-	DIFF	
3	USB3_D+	DIFF	
4	GND	GND	
5	USB3_SSRX-	DIFF	
6	USB3_SSRX+	DIFF	
7	GND	GND	
8	USB3_SSTX-	DIFF	
9	USB3_SSTX+	DIFF	
10	+5VSB	PWR	+5V
11	USB4_D-	DIFF	
12	USB4_D+	DIFF	
13	GND	GND	
14	USB4_SSRX-	DIFF	
15	USB4_SSRX+	DIFF	
16	GND	GND	
17	USB4_SSTX-	DIFF	
18	USB4_SSTX+	DIFF	

## 2.4.25 LAN (RJ-45) + Dual USB3.2 Gen 1 (CN15)

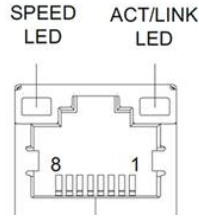

Pin	Signal	Signal Type	Signal Level
1	MDI0+	DIFF	
2	MDI0-	DIFF	
3	MDI1+	DIFF	
4	MDI2+	DIFF	
5	MDI2-	DIFF	
6	MDI1-	DIFF	
7	MDI3+	DIFF	
8	MDI3-	DIFF	

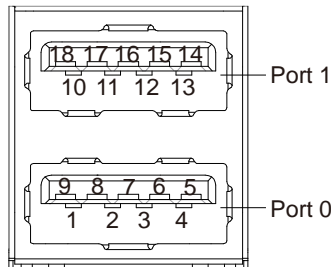

Pin	Signal	Signal Type	Signal Level
1	+5VSB	PWR	+5V
2	USB5_D-	DIFF	

Pin	Signal	Signal Type	Signal Level
3	USB5_D+	DIFF	
4	GND	GND	
5	USB5_SSRX-	DIFF	
6	USB5_SSRX+	DIFF	
7	GND	GND	
8	USB5_SSTX-	DIFF	
9	USB5_SSTX+	DIFF	
10	+5VSB	PWR	+5V
11	USB6_D-	DIFF	
12	USB6_D+	DIFF	
13	GND	GND	
14	USB6_SSRX-	DIFF	
15	USB6_SSRX+	DIFF	
16	GND	GND	
17	USB6_SSTX-	DIFF	
18	USB6_SSTX+	DIFF	

## 2.4.26 LAN (RJ-45) + Dual USB3.2 Gen 1 (CN14)

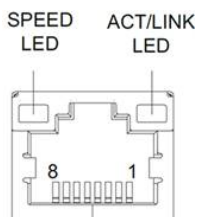

Pin	Signal	Signal Type	Signal Level
1	MDIO+	DIFF	



Pin	Signal	Signal Type	Signal Level
2	MDI0-	DIFF	
3	MDI1+	DIFF	
4	MDI2+	DIFF	
5	MDI2-	DIFF	
6	MDI1-	DIFF	
7	MDI3+	DIFF	
8	MDI3-	DIFF	

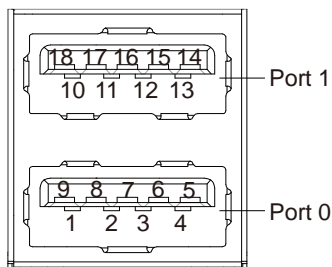

Pin	Signal	Signal Type	Signal Level
1	+5VSB	PWR	+5V
2	USB7_D-	DIFF	
3	USB7_D+	DIFF	
4	GND	GND	
5	USB7_SSRX-	DIFF	
6	USB7_SSRX+	DIFF	
7	GND	GND	
8	USB7_SSTX-	DIFF	
9	USB7_SSTX+	DIFF	
10	+5VSB	PWR	+5V

Pin	Signal	Signal Type	Signal Level
11	USB8_D-	DIFF	
12	USB8_D+	DIFF	
13	GND	GND	
14	USB8_SSRX-	DIFF	
15	USB8_SSRX+	DIFF	
16	GND	GND	
17	USB8_SSTX-	DIFF	
18	USB8_SSTX+	DIFF	

## 2.4.27 PCIe [x4] Slot (CN8)

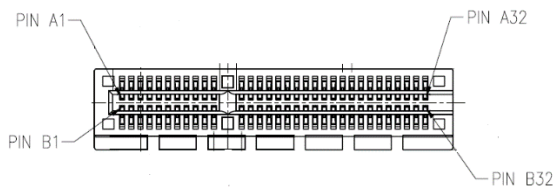

Pin	Signal	Signal Type	Signal Level
A1	PRSENT1#	I/O	
A2	+12V	PWR	+V12S
A3	+12V	PWR	+V12S
A4	GND	GND	
A5	PCIE_TXN5	DIFF	
A6	PCIE_TXP5	DIFF	
A7	PCIE_RXN5	DIFF	
A8	PCIE_RXP5	DIFF	

Pin	Signal	Signal Type	Signal Level
A9	+3.3V	PWR	+V3.3S
A10	+3.3V	PWR	+V3.3S
A11	PERST#	I/O	
A12	GND	GND	
A13	PCIE_x4SLOT_CLK	DIFF	
A14	PCIE_x4SLOT_CLK#	DIFF	
A15	GND	GND	
A16	PCIE_RXP24	DIFF	
A17	PCIE_RXN24	DIFF	
A18	GND	GND	
A19	NC		
A20	GND	GND	
A21	PCIE_RXP23	DIFF	
A22	PCIE_RXN23	DIFF	
A23	GND	GND	
A24	GND	GND	
A25	PCIE_RXP22	DIFF	
A26	PCIE_RXP22	DIFF	
A27	GND	GND	
A28	GND	GND	
A29	PCIE_RXP21	DIFF	
A30	PCIE_RXN21	DIFF	
A31	GND	GND	
A32	NC		
B1	+12V	PWR	+V12S
B2	+12V	PWR	+V12S

Pin	Signal	Signal Type	Signal Level
B3	+12V	PWR	+V12S
B4	GND	GND	
B5	SMB_CLK	I/O	
B6	SMB_DATA	I/O	
B7	GND	GND	
B8	+V3.3S	PWR	+V3.3S
B9	NC		
B10	3.3Vaux	PWR	+V3.3A
B11	WAKE#	I/O	
B12	NC		
B13	GND	GND	
B14	PCIE_TXP24	DIFF	
B15	PCIE_TXN24	DIFF	
B16	GND	GND	
B17	PRSNT	I/O	
B18	GND	GND	
B19	PCIE_TXP23	DIFF	
B20	PCIE_TXN23	DIFF	
B21	GND	GND	
B22	GND	GND	
B23	PCIE_TXP22	DIFF	
B24	PCIE_TXN22	DIFF	
B25	GND	GND	
B26	GND	GND	
B27	PCIE_TXP21	DIFF	
B28	PCIE_TXN21	DIFF	

Pin	Signal	Signal Type	Signal Level
B29	GND	GND	
B30	NC		
B31	PRSNT	I/O	
B32	GND	GND	

## 2.4.28 SIM Slot (SIM1)

---

Pin	Signal	Signal Type	Signal Level
1	UIM_PWR	PWR	
2	UIM_RST	IN	
3	UIM_CLK	IN	
4	GND	GND	
5	UIM_VPP	PWR	
6	UIM_DATA	I/O	

## 2.5 CPU Installation

Before installing the CPU, ensure the system is powered down and disconnect the power cord from the system. Make sure you have the processor ready to install. See Chapter 1 Specifications for list of compatible CPU/processors.

**Step 1:** Remove the screws on the front and back of the BOXER-6641 as shown in the figure below (six in total), and remove the top heatsink.

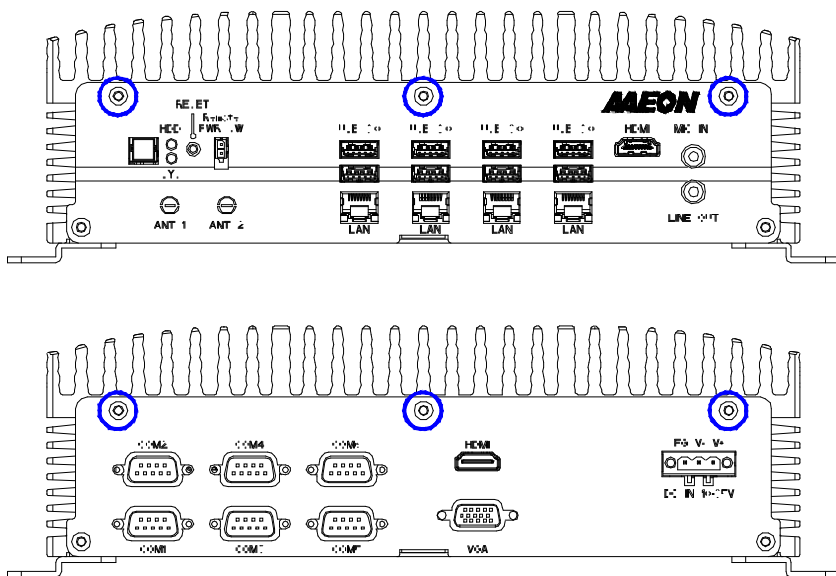

**Step 2:** Install the CPU into the socket and place the thermal pad on top of the processor.

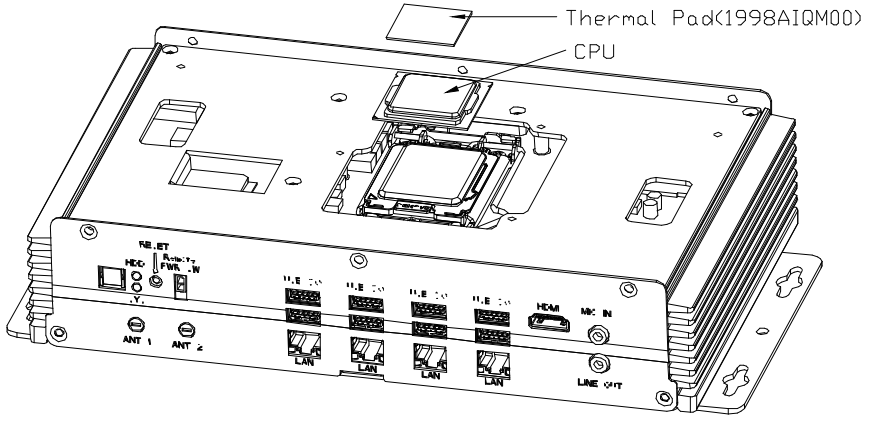

**Step 3:** Place the heatsink back on and secure with the screws you removed in Step 1.

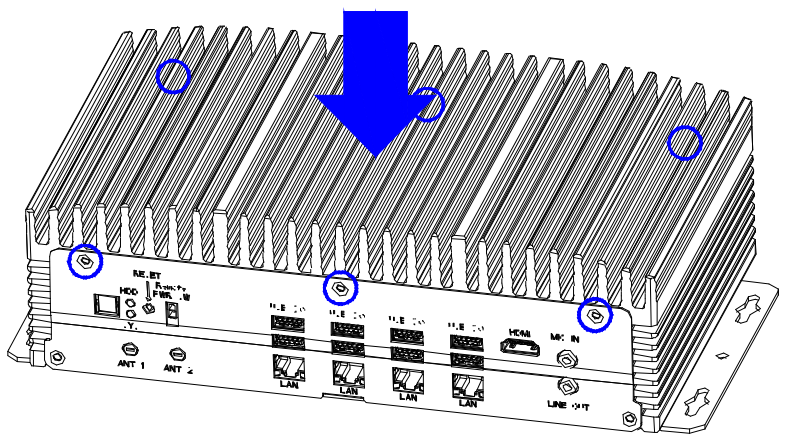

## 2.6 Memory RAM Module Installation

Before installing the RAM, ensure the system is powered down and disconnect the power cord from the system. Make sure you have the RAM module ready to install. See Chapter 1 for RAM requirements and specifications.

**Step 1:** Remove the eight (8) screws from the bottom of the BOXER-6641 as shown in the figure below. Remove the bottom panel from the system.

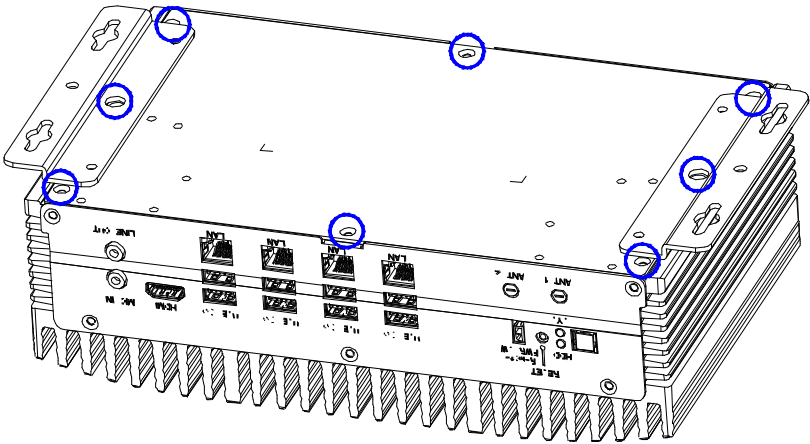



**Step 2:** Place thermal pads on the RAM modules and insert them into the RAM slots.

Note the figure below for placement of thermal pads. When inserting the modules into the RAM slots, first insert at an angle ( $\sim 30^\circ$ ), then gently push down until secure.

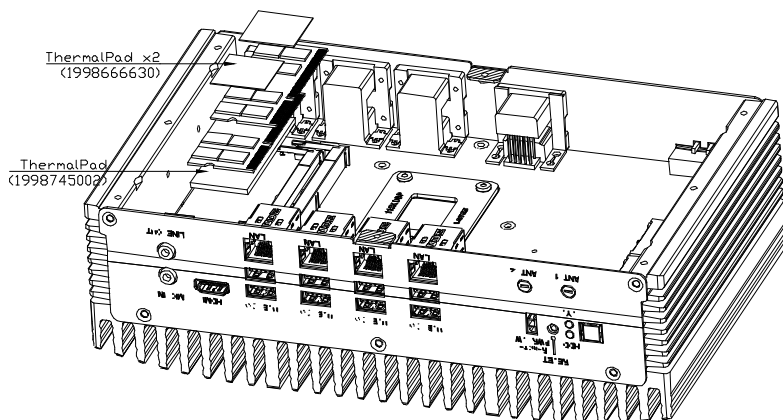

**Step 3:** Install the RAM bracket. Ensure it is oriented as shown in the figure below.

Attach the bracket to the chassis using two screws.

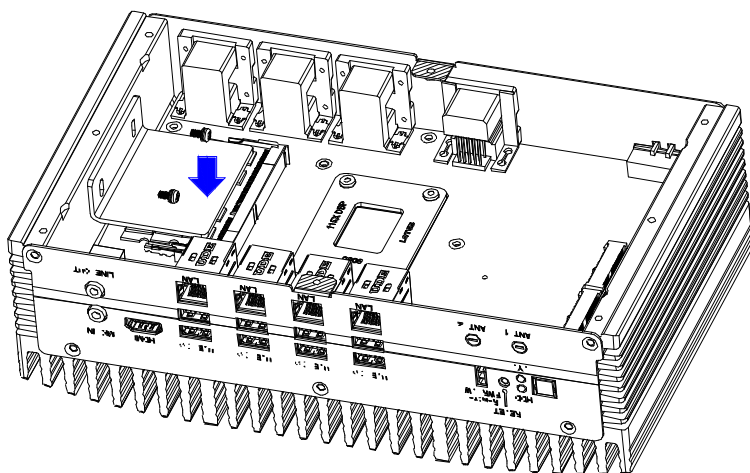

RAM installation is complete. If you also need to install the 2.5" SATA Drive, continue to the next section. If you are done, replace the bottom panel and secure with the eight (8) screws you removed in Step 1 of this section.

## 2.7 2.5" SATA Drive Installation

---

Before installing the SATA Drive, ensure the system is powered down and disconnect the power cord from the system. Make sure you have the SATA Drive ready to install. See Chapter 1 for SATA drive specifications for compatibility.

**Step 1:** If you have not already done so, remove the eight (8) screws from the bottom of the BOXER-6641 as shown in the figure below. Remove the bottom panel from the system.

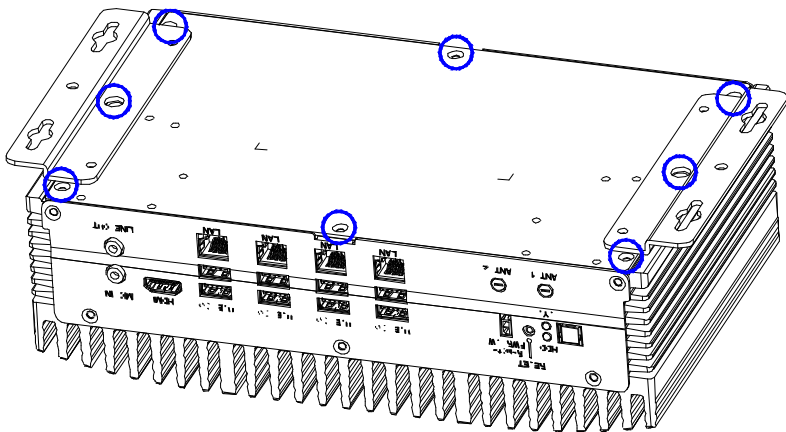

**Step 2:** Attach the SATA drive to the HDD Bracket using the screws provided.

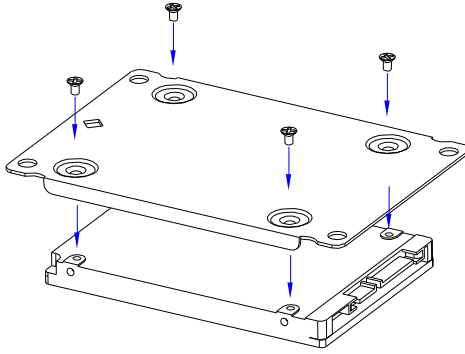

**Step 3:** Attach the HDD Bracket to the bottom panel using four screws as shown in the figure below. Attach the SATA and SATA Power cables to the board and the SATA drive.

Step 1: Use the HDD screws provided to assemble 2.5" SATA drive with the HDD Bracket

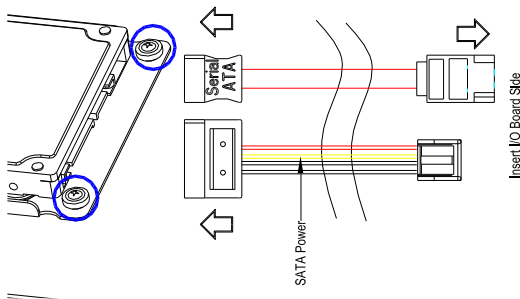
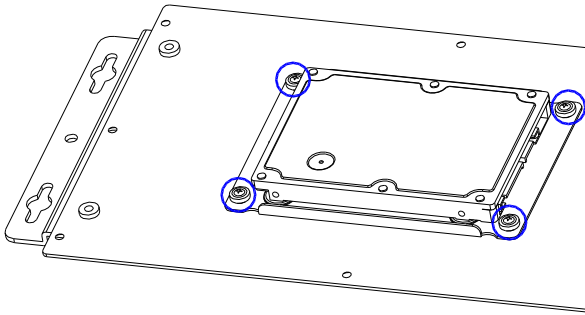

**Step 4:** Replace the bottom panel and secure with the eight (8) screws you removed in Step 1.

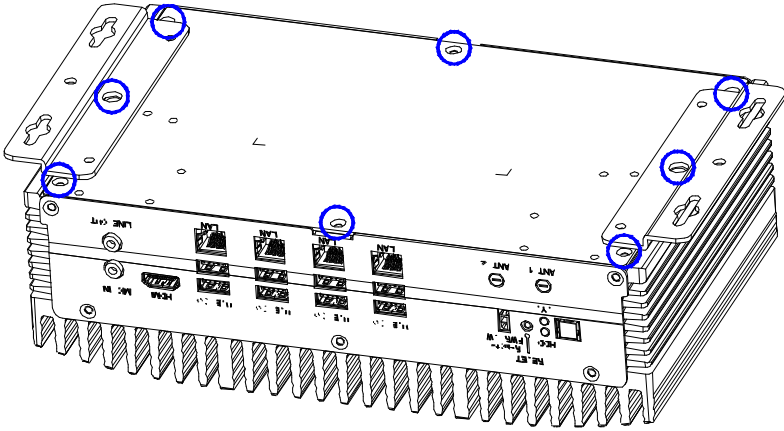

## 2.8 Power Connector Installation

**Step 1:** Take out the 3-pin green phoenix power connector from the accessory kit.



**Step 2:** Connect to the power input port shown in the diagram:

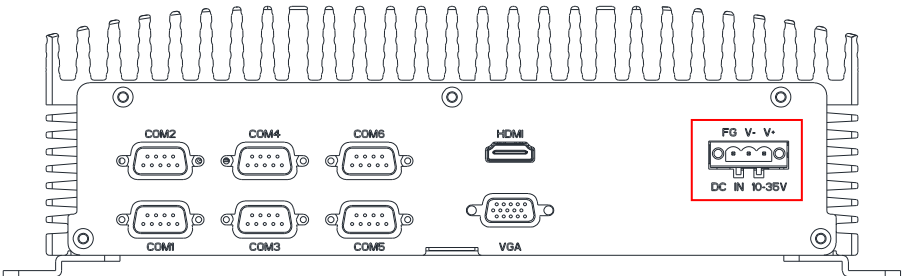

# Chapter 3

---

AMI BIOS Setup

## 3.1 System Test and Initialization

---

The system uses certain routines to perform testing and initialization during the boot up sequence. If an error, fatal or non-fatal, is encountered, the system will output a few short beeps or an error message. The board can usually continue the boot up sequence with non-fatal errors.

The system configuration verification routines check the current system configuration against the values stored in the CMOS memory. If they do not match, an error message will be output, and the BIOS setup program will need to be run to set the configuration information in memory.

There are three situations in which the CMOS settings will need to be set or changed:

- Starting the system for the first time
- The system hardware has been changed
- The CMOS memory has lost power and the configuration information is erased

The system's CMOS memory uses a backup battery for data retention. The battery must be replaced when it runs down.

## 3.2 AMI BIOS Setup

---

The AMI BIOS ROM has a pre-installed Setup program that allows users to modify basic system configurations, which is stored in the battery-backed CMOS RAM and BIOS NVRAM so that the information is retained when the power is turned off.

To enter BIOS Setup, press <Del> or <F2> immediately while your computer is powering up.

The function for each interface can be found below.

**Main** – Date and time can be set here. Press <Tab> to switch between date elements

**Advanced** – Enable/ Disable boot option for legacy network devices

**Chipset** – For hosting bridge parameters

**Security** – The setup administrator password can be set here

**Boot** – Enable/ Disable Quiet Boot option

**Save & Exit** – Save your changes and exit the program



### 3.3 Setup Submenu: Main

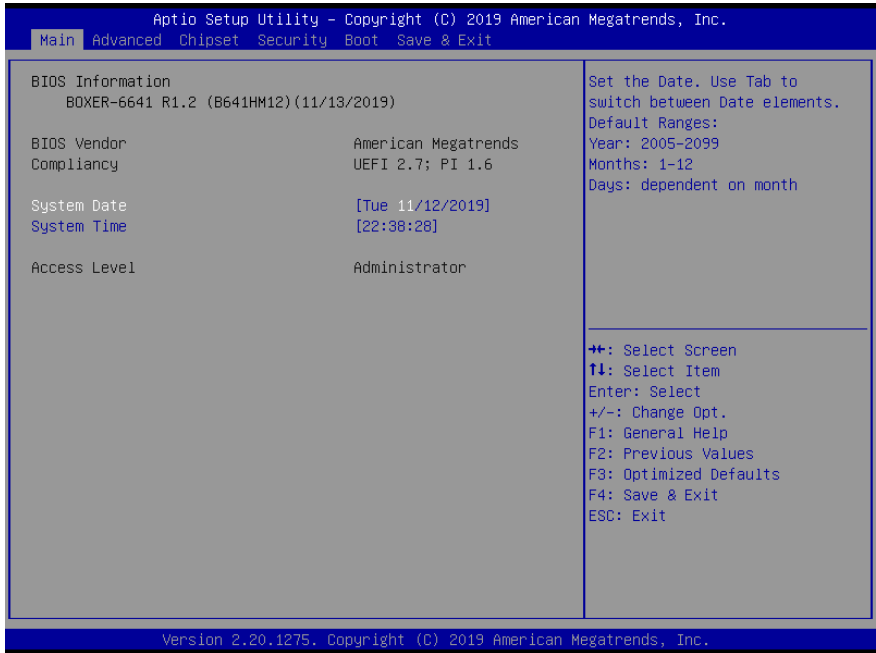

### 3.4 Setup Submenu: Advanced

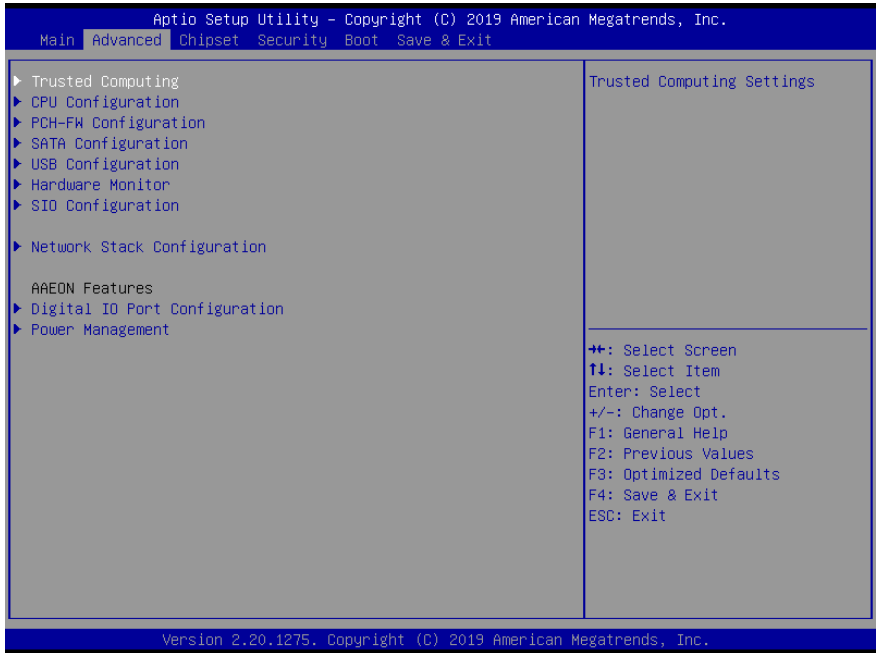

### 3.4.1 Advanced: Trusted Computing

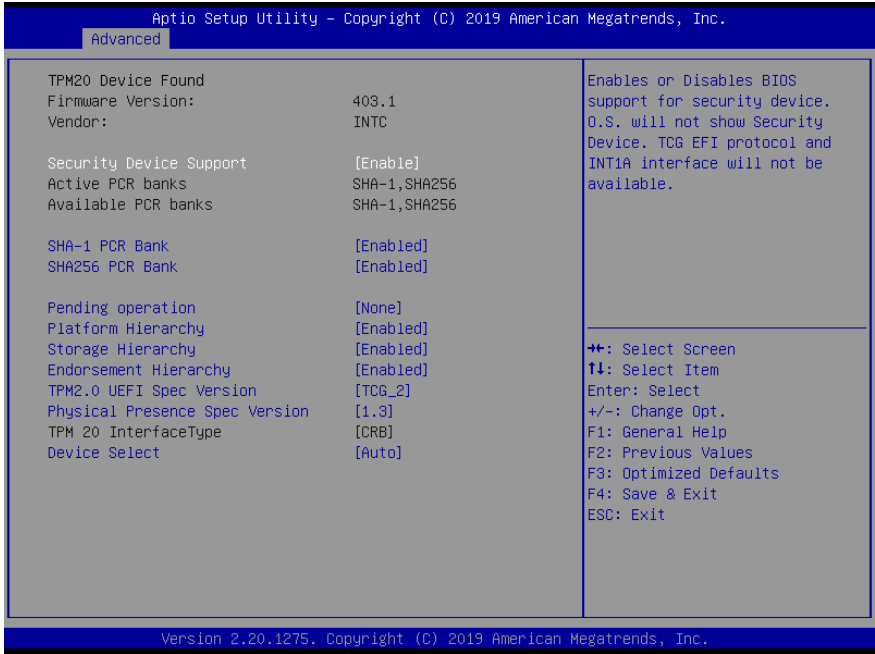

Options Summary		
Security Device Support	Enable	Optimal Default, Failsafe Default
	Disable	
Enable or Disable BIOS support for security device. TCG EFI protocol and INT1A interface will not be available.		
SHA-1 PCR Bank	Enabled	Optimal Default, Failsafe Default
	Disabled	
Enable or Disable SHA-1 PCR Bank		
SHA256 PCR Bank	Enabled	Optimal Default, Failsafe Default
	Disabled	
Enable or Disable SHA256 PCR Bank		
Pending operation	None	Optimal Default, Failsafe Default
	TPM Clear	
Schedule an Operation for the Security Device. NOTE: Your Computer will reboot during restart in order to change State of Security Device.		

Options Summary		
Platform Hierarchy	Enabled	Optimal Default, Failsafe Default
	Disabled	
Enable or Disable Platform Hierarchy		
Storage Hierarchy	Enabled	Optimal Default, Failsafe Default
	Disabled	
Enable or Disable Storage Hierarchy		
Endorsement Hierarchy	Enabled	Optimal Default, Failsafe Default
	Disabled	
Enable or Disable Endorsement Hierarchy		
TPM2.0 UEFI Spec Version	TCG_2	Optimal Default, Failsafe Default
	TCG_1_2	
Select the TCG2 Spec Version Support TCG_1_2: Compatible mode for Win8/Win10 TCG_2: Support new TCG2 protocol and event format for Win10 or later		
Physical Presence Spec Version	1.3	Optimal Default, Failsafe Default
	1.2	
Select to Tell O.S. to support PPI Spec Version 1.2 or 1.3. Note some HCK tests might not support 1.3.		
Device Select	Auto	Optimal Default, Failsafe Default
	TPM 1.2	
	TPM 2.0	
TPM 1.2 will restrict support to TPM 1.2 devices, TPM 2.0 will restrict support to TPM 2.0 devices, Auto will support both with the default set to TPM 2.0 devices if not found, TPM 1.2 devices will be enumerated		

### 3.4.2 Advanced: CPU Configuration

Aptio Setup Utility - Copyright (C) 2019 American Megatrends, Inc.

Advanced

CPU Configuration		Enabled or Disabled Hyper-Threading Technology.
Name	CoffeeLake DT	
Type	Intel(R) Xeon(R) E-2176G CPU @ 3.70GHz	
Speed	3700 MHz	
ID	0x906EA	
Stepping	U0	
Package	LGA1151	
Number of Processors	6Core(s) / 12Thread(s)	
Microcode Revision	C6	
GT Info	GT2 (0x3E96)	
eDRAM Size	N/A	
VMX	Supported	
SMX/TXT	Supported	
Intel (VMX) Virtualization Technology	[Enabled]	
Active Processor Cores	[All]	
Intel(R) SpeedStep(tm)	[Enabled]	
Intel(R) Speed Shift Technology	[Disabled]	
Turbo Mode	[Enabled]	
C states	[Disabled]	
Hyper-Threading	[Enabled]	
		++: Select Screen ↑↓: Select Item Enter: Select +/-: Change Opt. F1: General Help F2: Previous Values F3: Optimized Defaults F4: Save & Exit ESC: Exit

Version 2.20.1275. Copyright (C) 2019 American Megatrends, Inc.

Options Summary		
<b>Intel (VMX) Virtualization Technology</b>	Disabled	Optimal Default, Failsafe Default
	Enabled	
When enabled, a VMM can utilize the additional hardware capabilities provided by Vanderpool Technology.		
<b>Active Processor Cores</b>	1	Optimal Default, Failsafe Default
	2	
	3	
	All	
Number of cores to enable in each processor package.		
<b>Intel(R) SpeedStep(tm)</b>	Disabled	Optimal Default, Failsafe Default
	Enabled	
Allows more than two frequency ranges to be supported.		

*Table Continues on Next Page...*

Options Summary		
<b>Intel(R) Speed Shift Technology</b>	Disabled	Optimal Default, Failsafe Default
	Enabled	
Enable/Disable Intel(R) Speed Shift Technology support. Enabling will expose the CPPC v2 interface to allow for hardware controlled P-states.		
<b>Turbo Mode</b>	Disabled	Optimal Default, Failsafe Default
	Enabled	
Enable/Disable Processor Turbo Mode (requires Intel Speed Step or Intel Speed Shift to be available or enabled).		
<b>C states</b>	Disabled	Optimal Default, Failsafe Default
	Enabled	
Enable/Disable CPU Power Management. Allows CPU to go C states when it's not 100% utilized		
<b>Hyper-Threading</b>	Disabled	Optimal Default, Failsafe Default
	Enabled	
Enabled or Disabled Hyper-Threading Technology.		

### 3.4.3 Advanced: PCH-FW Configuration

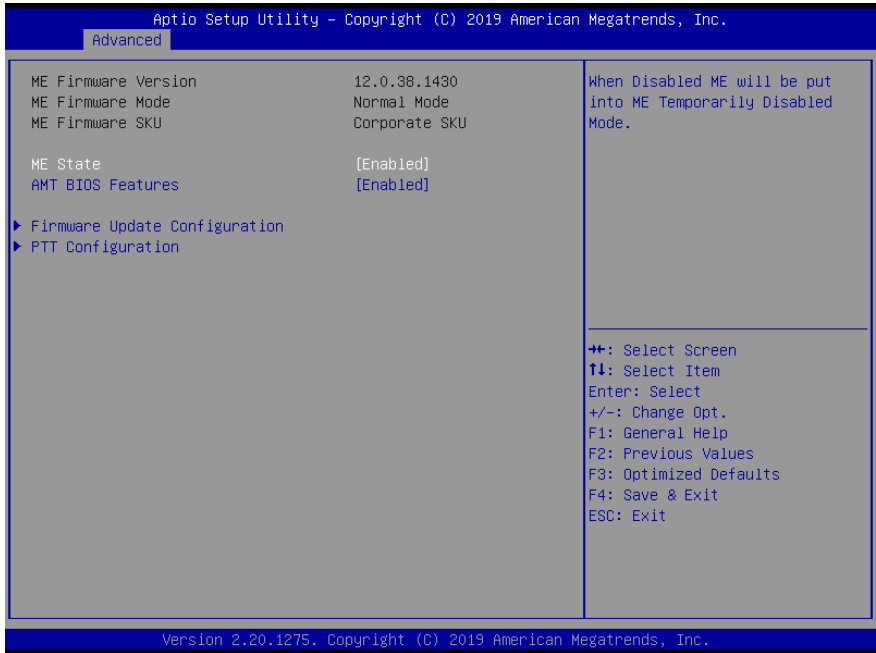

#### Options Summary

ME State	Enabled	Optimal Default, Failsafe Default
	Disabled	
When Disabled ME will be put into ME Temporarily Disabled Mode.		
AMT BIOS Feature	Enabled	Optimal Default, Failsafe Default
	Disabled	
When disabled AMT BIOS Features are no longer supported and user is no longer able to access MEBx Setup.		
<b>Note:</b> This option does not disable Manageability Features in FW.		

### 3.4.3.1 Firmware Update Configuration

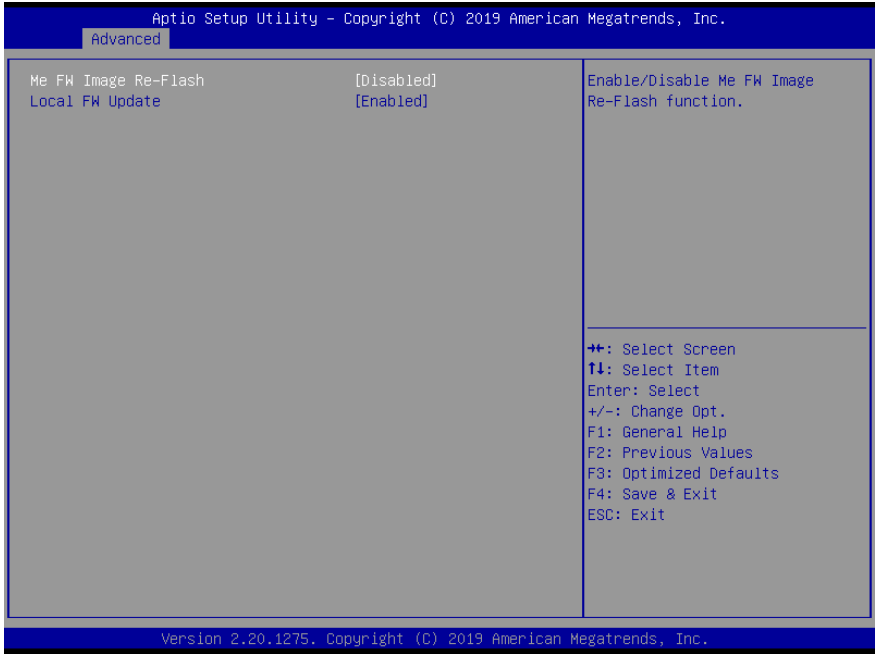

Options Summary		
ME FW Image Re-Flash	Enabled	Optimal Default, Failsafe Default
	Disabled	
Enable/Disable ME FW Image Re-Flash function.		
Local FW Update	Enabled	Optimal Default, Failsafe Default
	Disabled	
Options for Local FW Update function.		



### 3.4.3.2 PTT Configuration

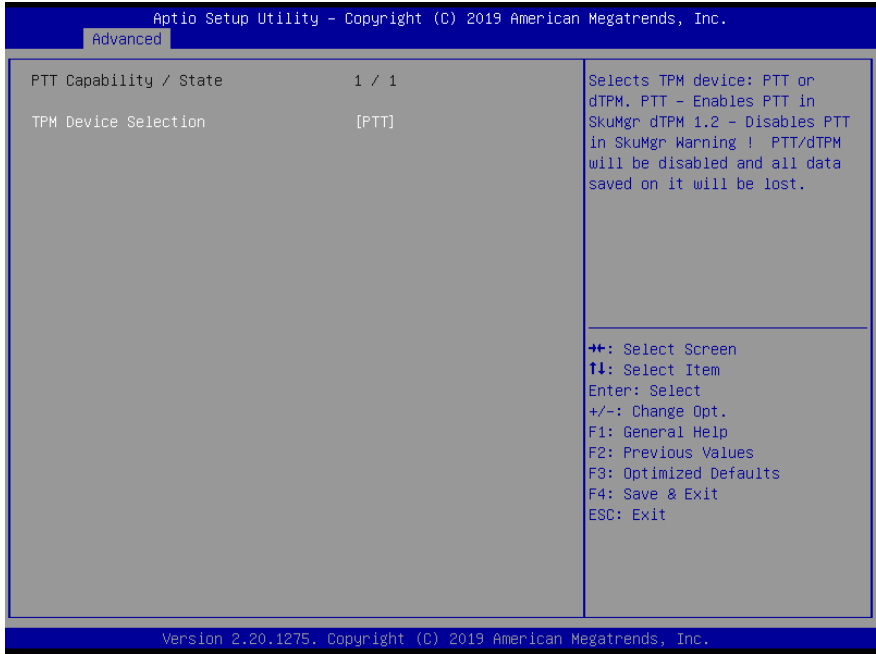

Options Summary		
ME FW Image Re-Flash	dTPM	
	PTT	Optimal Default, Failsafe Default
<p>Selects TPM device: PTT or dTPM.                      PTT – Enables PTT in SkuMgr                      dTPM 1.2 – Disables PTT in SkuMgr <b>Warning!</b> PTT/dTPM will be disabled and all saved data will be lost.</p>		

### 3.4.4 Advanced: SATA Configuration

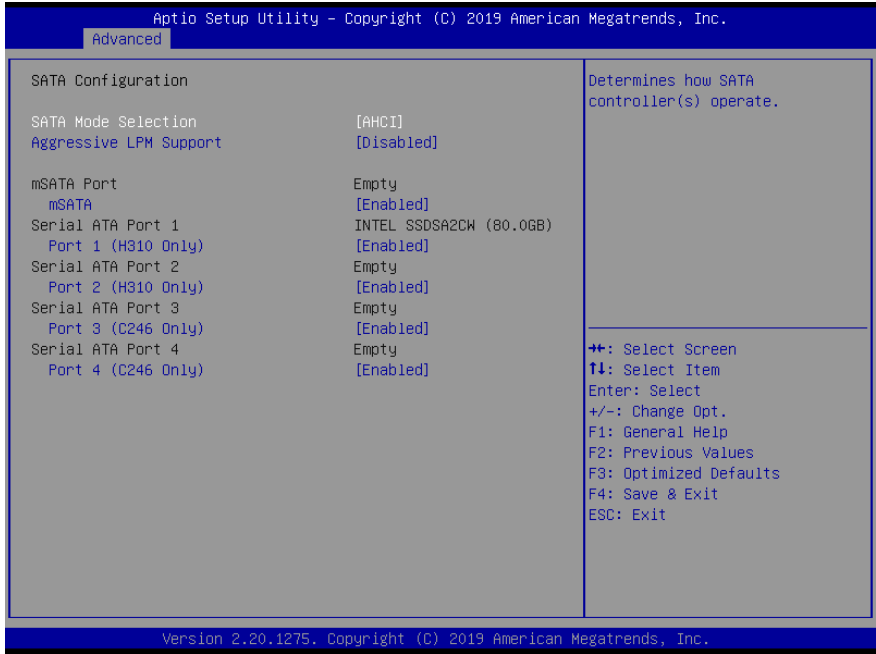

Options Summary		
<b>SATA Mode Selection</b>	AHCI Mode	Optimal Default, Failsafe Default
	Intel RST Premium With Intel Optane System Acceleration	
Determines how SATA controller(s) operate.		
<b>Aggressive LPM Support</b>	Enabled	Optimal Default, Failsafe Default
	Disabled	
Enable PCH to aggressively enter link power state.		
<b>mSATA</b>	Enabled	Optimal Default, Failsafe Default
	Disabled	
Enable or Disable SATA Port.		
<b>Port 1/2/3/4</b>	Enabled	Optimal Default, Failsafe Default
	Disabled	
Enable or Disable SATA Port.		

### 3.4.5 Advanced: USB Configuration

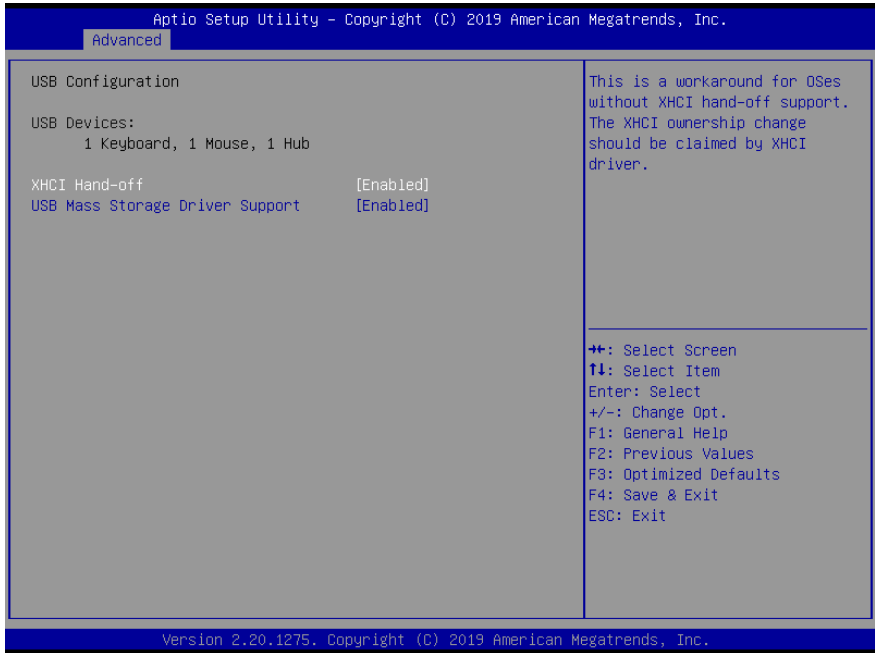

Options Summary		
XHCI Hand-off	Enabled	Optimal Default, Failsafe Default
	Disabled	
This is a workaround for OSes without XHCI Hand-off support. The XHCI ownership change should be claimed by XHCI driver.		
USB Mass Storage Driver Support	Enabled	Optimal Default, Failsafe Default
	Disabled	
Enable/Disable USB Mass Storage Driver Support.		

### 3.4.6 Advanced: Hardware Monitor

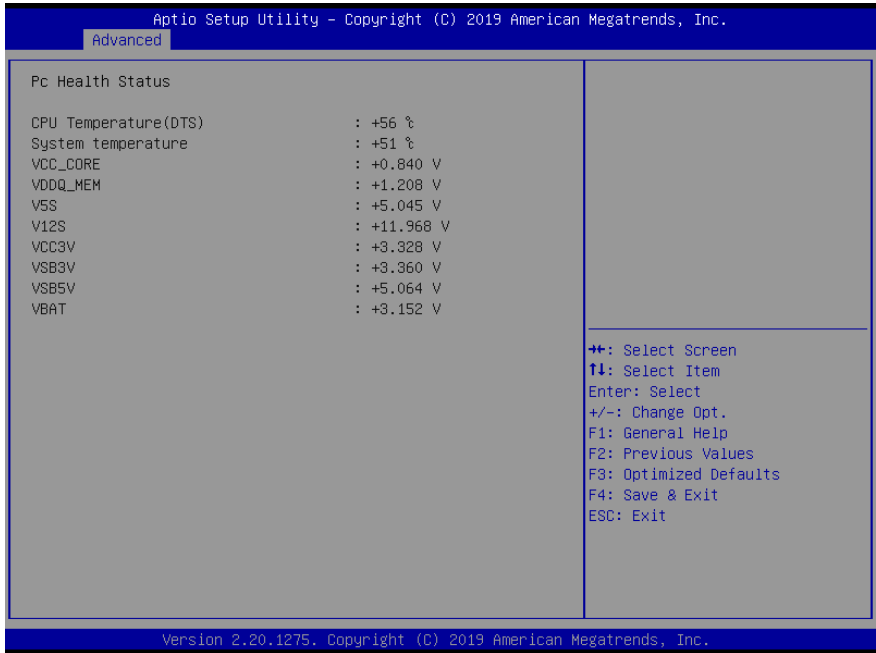

### 3.4.7 Advanced: SIO Configuration

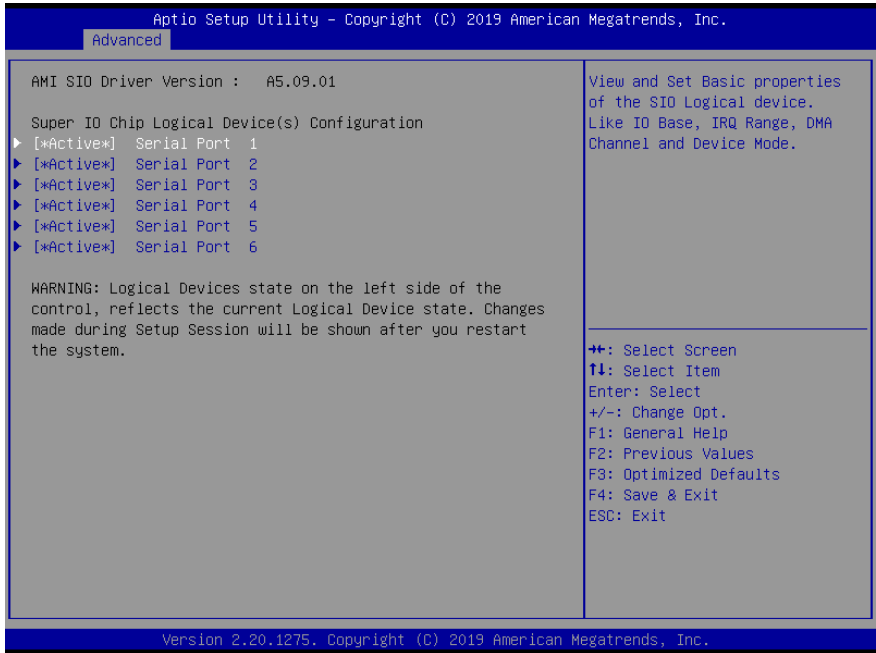

### 3.4.7.1 Serial Port 1 Configuration

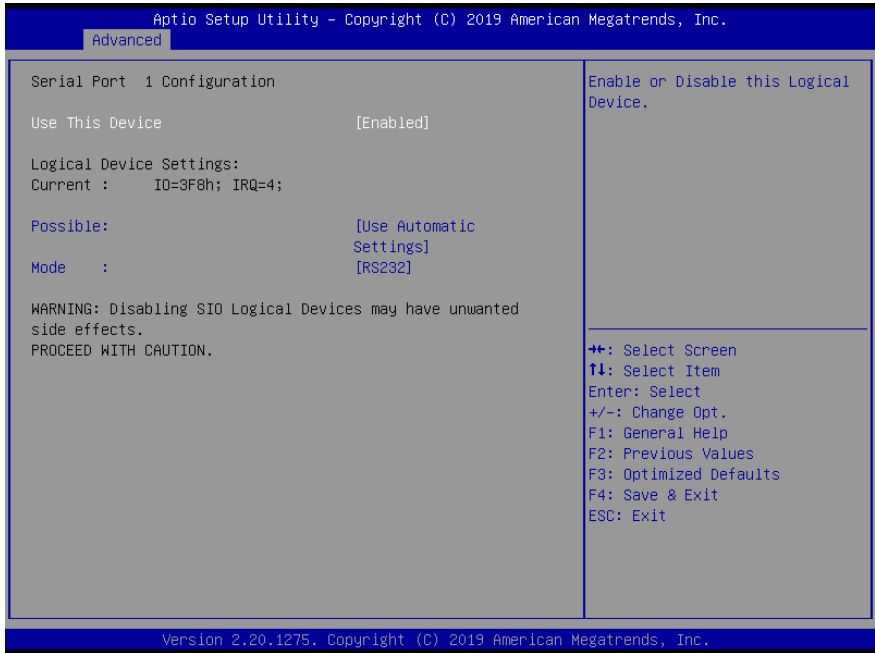

Options Summary		
Use This Device	Enabled	Optimal Default, Failsafe Default
	Disabled	
Enabled or Disabled this Logical Device.		
Device resource settings	USB Automatic Setting	Optimal Default, Failsafe Default
	IO=3F8h; IRQ = 4;	
	IO=2F8h; IRQ = 3;	
Allows the user to change the device resource settings. New settings will be reflected on this setup page after system restarts.		
UART selection	RS232	Optimal Default, Failsafe Default
	RS422	
	RS485	
UART RS232, 422, 485 selection.		







### 3.4.7.4 Serial Port 4 Configuration

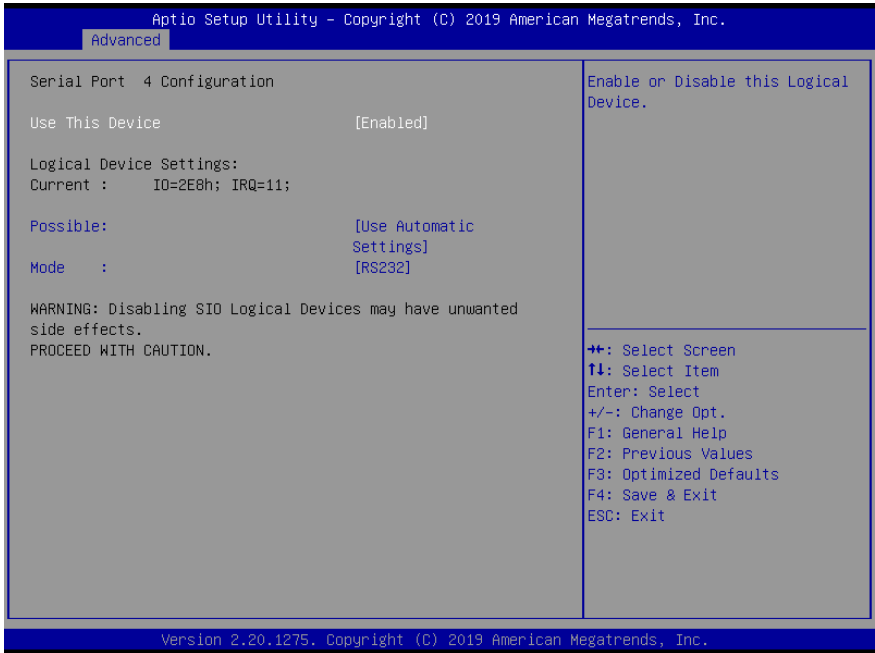

Options Summary		
Use This Device	Enabled	Optimal Default, Failsafe Default
	Disabled	
Enabled or Disabled this Logical Device.		
Device resource settings	USB Automatic Setting	Optimal Default, Failsafe Default
	IO=2E8h; IRQ = 11;	
	IO=3E8h; IRQ = 11;	
Allows the user to change the device resource settings. New settings will be reflected on this setup page after system restarts.		
UART selection	RS232	Optimal Default, Failsafe Default
	RS422	
	RS485	
UART RS232, 422, 485 selection.		

### 3.4.7.5 Serial Port 5 Configuration

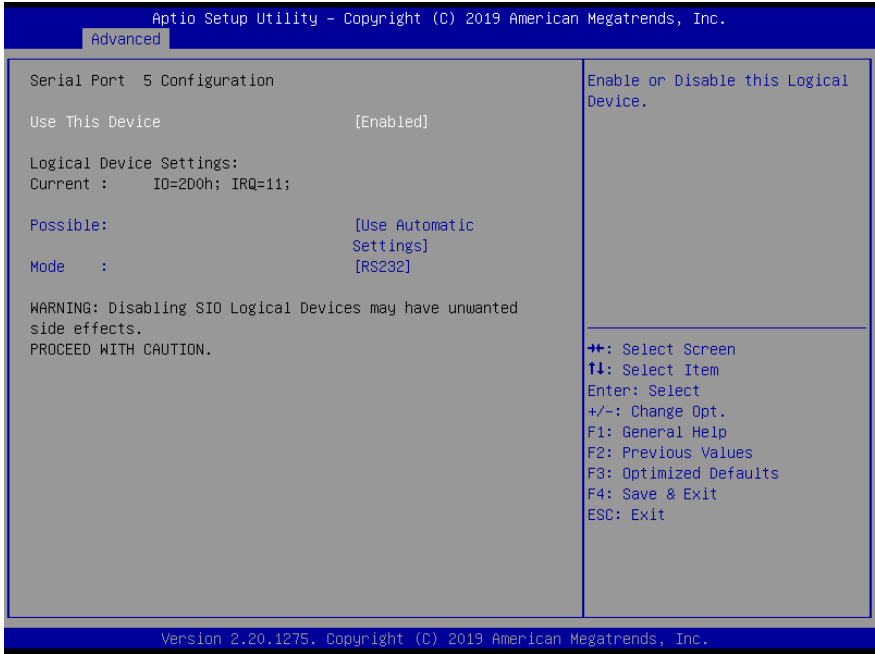

Options Summary		
Use This Device	Enabled	Optimal Default, Failsafe Default
	Disabled	
Enabled or Disabled this Logical Device.		
Device resource settings	USB Automatic Setting	Optimal Default, Failsafe Default
	IO=2D0h; IRQ = 11;	
	IO=2C0h; IRQ = 11;	
Allows the user to change the device resource settings. New settings will be reflected on this setup page after system restarts.		
UART selection	RS232	Optimal Default, Failsafe Default
	RS422	
	RS485	
UART RS232, 422, 485 selection.		

### 3.4.7.6 Serial Port 6 Configuration

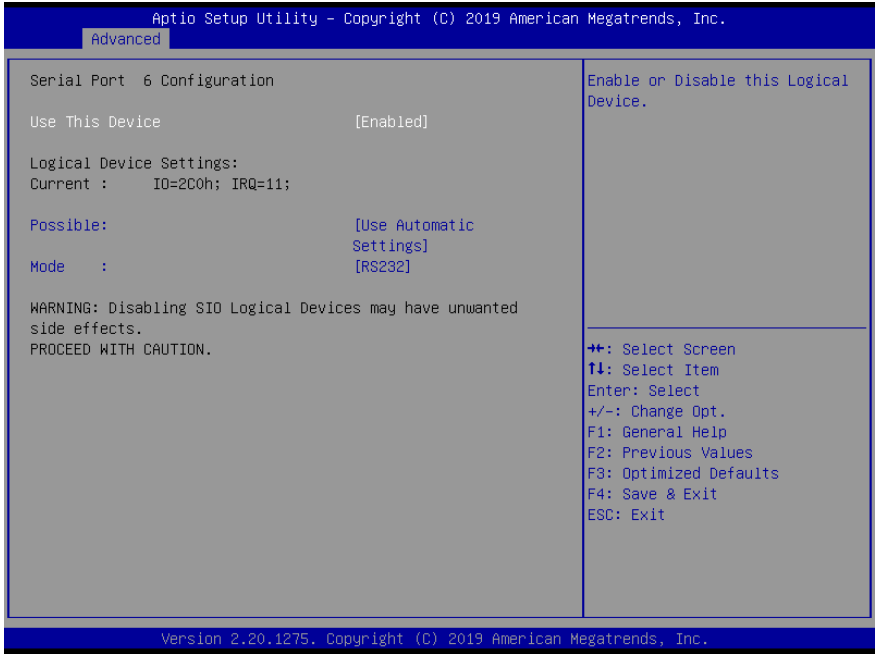

Options Summary		
Use This Device	Enabled	Optimal Default, Failsafe Default
	Disabled	
Enabled or Disabled this Logical Device.		
Device resource settings	USB Automatic Setting	Optimal Default, Failsafe Default
	IO=2C0h; IRQ = 11;	
	IO=2D0h; IRQ = 11;	
Allows the user to change the device resource settings. New settings will be reflected on this setup page after system restarts.		
UART selection	RS232	Optimal Default, Failsafe Default
	RS422	
	RS485	
UART RS232, 422, 485 selection.		

### 3.4.8 Advanced: Network Stack Configuration

#### Network Stack Disabled:

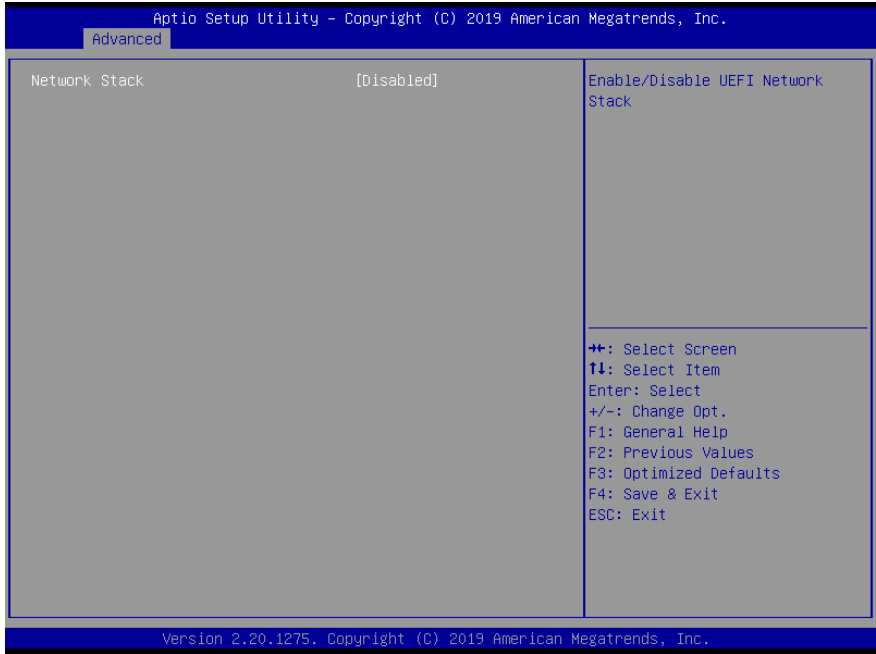

#### Options Summary

Network Stack	Disabled	Optimal Default, Failsafe Default
	Enabled	
Enable/Disable UEFI Network Stack		

**Network Stack Enabled:**

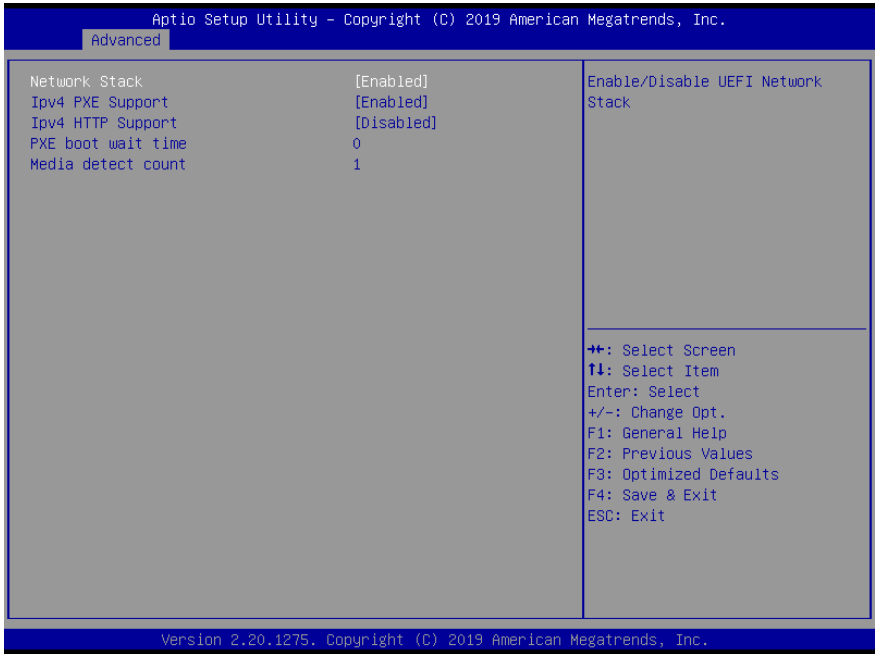

Options Summary		
<b>Network Stack</b>	Disabled	Optimal Default, Failsafe Default
	Enabled	
Enable/Disable UEFI Network Stack		
<b>Ipv4 PXE Support</b>	Disabled	Optimal Default, Failsafe Default
	Enabled	
Enable/Disable IPv4 PXE boot support. If disabled, IPv4 PXE boot support will not be available.		
<b>Ipv4 HTTP Support</b>	Disabled	Optimal Default, Failsafe Default
	Enabled	
Enable/Disable IPv4 HTTP boot support. If disabled, IPv4 HTTP boot support will not be available.		
<b>PXE boot wait time</b>	0	Optimal Default, Failsafe Default
Wait time in seconds to press ESC key to abort the PXE boot. Use either +/- or numeric keys to set the value.		

*Table Continues on Next Page...*

### Options Summary

<b>Media detect count</b>	1	Optimal Default, Failsafe Default
Number of times the presence of media will be checked. Use either +/- or numeric keys to set the value.		

### 3.4.9 Advanced: Digital IO Port Configuration

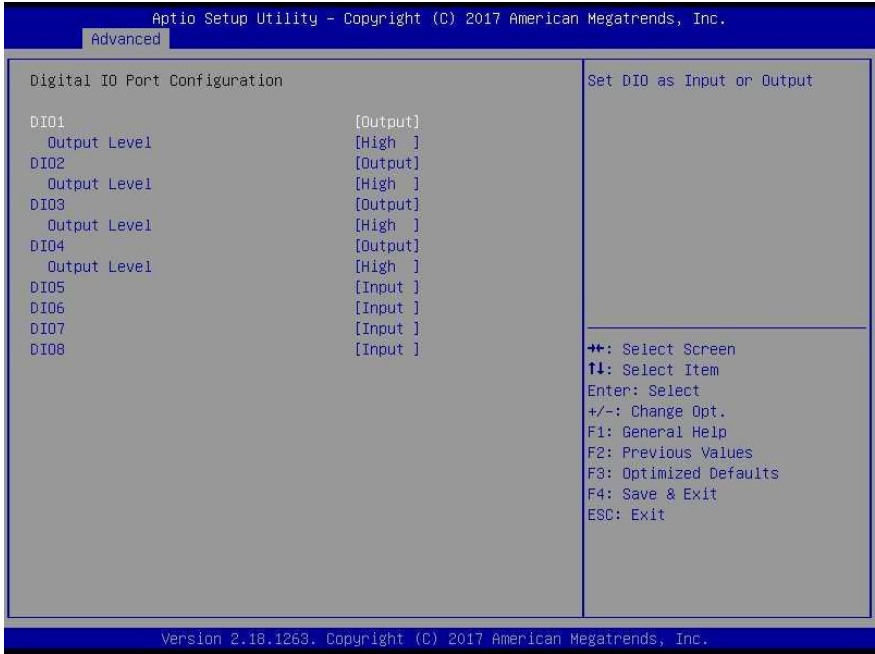

Options Summary		
DIO Type	Output	Optimal Default, Failsafe Default
	Input	
Set DIO as Input or Output		
DIO Data	Low	Optimal Default, Failsafe Default
	High	
Set is output level when DIO pin is output		

### 3.4.10 Advanced: Power Management

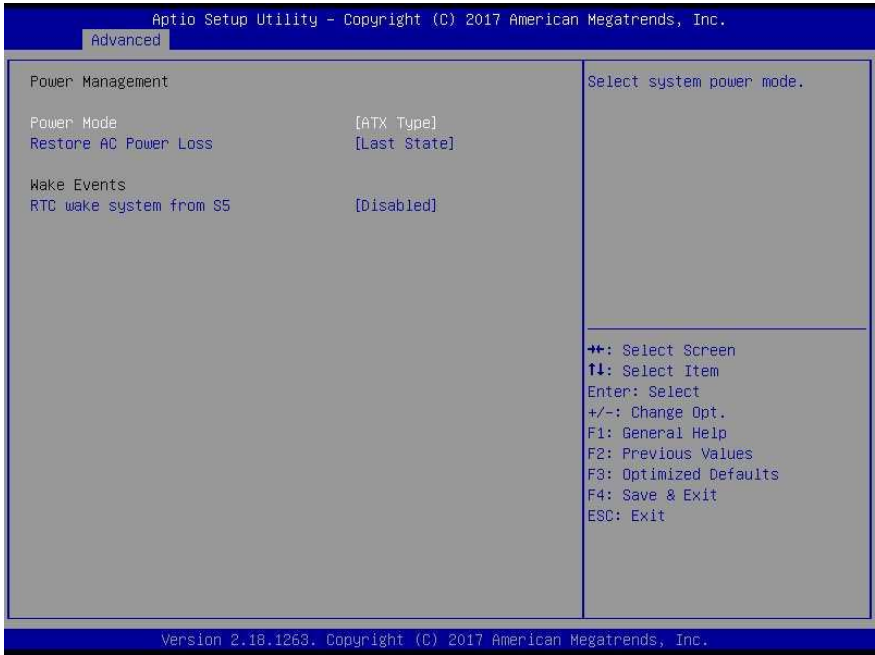

Options Summary		
Power Mode	ATX Type	Optimal Default, Failsafe Default
	AT Type	
Select power supply mode.		
AC Power Loss	Last State	Optimal Default, Failsafe Default
	Power On	
	Power Off	
Select power state when power is re-applied after a power failure.		
RTC wake system from S5	Disabled	Optimal Default, Failsafe Default
	Enabled	
Fixed Time: System will make on the hr::min::sec specified.		
Dynamic Time: System will wake on the current time + Increase minute(S)		

*Table Continues on Next Page...*



Options Summary	
RTC wake system from S5	Enabled
Wake up day	0
Select 0 for daily system wake up, 1-31 for which day of the month that you would like system to wake up	
Wake up hour	0
Select 0-23; For example enter 3 for 3am and 15 for 3pm	
Wake up minute	0
0 – 59	
Wake up second	0
0 - 59	

### 3.5 Setup submenu: Chipset

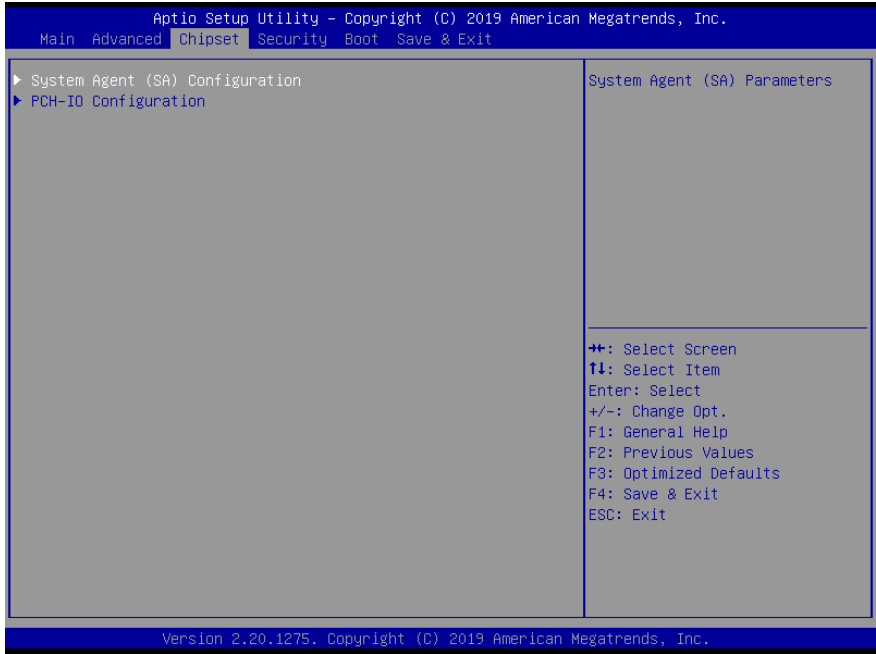

### 3.5.1 Chipset: System Agent (SA) Configuration

Aptio Setup Utility - Copyright (C) 2019 American Megatrends, Inc.

Chipset

System Agent (SA) Configuration		System Agent Geyserville. Fixed Low/Mid/High: SA GV disabled, MRC only runs tasks from Low, Mid, or High point. SA GV will be disabled on DT/Halo CPUs, regardless of this setting.
Total Memory	16384 MB	
Memory Frequency	2133 MHz	
Memory Timings (tCL-tRCD-tRP-tRAS)	15-15-15-36	
Channel 0 Slot 0	Populated & Enabled	
Size	16384 MB (DDR4)	
Number of Ranks	2	
Channel 1 Slot 0	Not Populated / Disabled	
VT-d	Supported	
SA GV	[Enabled]	++: Select Screen ↑↓: Select Item Enter: Select +/-: Change Opt. F1: General Help F2: Previous Values F3: Optimized Defaults F4: Save & Exit ESC: Exit
PM Support	[Enabled]	
RC6(Render Standby)	[Enabled]	
DVMT Total Gfx Mem	[MAX]	
VT-d	[Disabled]	
Skip Scanning of External Gfx Card	[Disabled]	

Version 2.20.1275. Copyright (C) 2019 American Megatrends, Inc.

Options Summary		
<b>SA GV</b>	Enabled	Optimal Default, Failsafe Default
	Disabled	
	Fixed Low	
	Fixed High	
System Agent Geyserville. Fixed Low/Mid/High: SA GV disabled, MRC only runs tasks from Low, Mid, or High point. SA GV will be disabled on DT/Halo CPUs, regardless of this setting.		
<b>PM Support</b>	Enabled	Optimal Default, Failsafe Default
	Disabled	
Enable/Disable PM Support.		
<b>RC6(Render Standby)</b>	Enabled	Optimal Default, Failsafe Default
	Disabled	
Check to enable render standby support.		

*Table Continues on Next Page...*

Options Summary		
DVMT Total Gfx Mem	128M	Optimal Default, Failsafe Default
	256M	
	MAX	
Select DVMT5.0 Total Graphic Memory sized used by the Internal Graphics Device.		
VT-d	Enabled	Optimal Default, Failsafe Default
	Disabled	
VT-d capability.		
Skip Scanning of External Gfx Card	Enabled	Optimal Default, Failsafe Default
	Disabled	
If Enabled, it will not scan for External Gfx Card on PEG and PCH PCIE Ports		

### 3.5.2 Chipset: PCH-IO Configuration

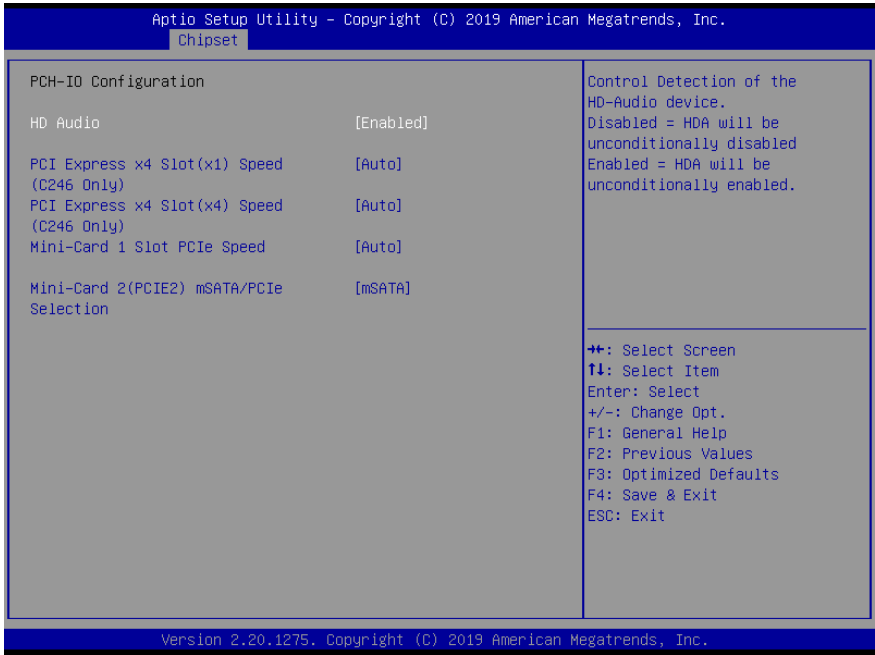

Options Summary		
HD Audio	Enabled	Optimal Default, Failsafe Default
	Disabled	
Control the Detection of the Audio device. Disabled = HDA will be unconditionally disabled. Enabled = HDA will be unconditionally enabled.		
PCI Express x4 Slot(x1) Speed (C246 Only)	Auto	Optimal Default, Failsafe Default
	Gen 1	
	Gen 2	
	Gen 3	
Configure PCIe Speed.		
PCI Express x4 Slot(x4) Speed (C246 Only)	Auto	Optimal Default, Failsafe Default
	Gen 1	
	Gen 2	
	Gen 3	
Configure PCIe Speed.		

Options Summary		
Mini-Card 1 Slot PCIe Speed	Auto	Optimal Default, Failsafe Default
	Gen 1	
	Gen 2	
Configure PCIe Speed.		
Mini-Card 2(PCIE2) mSATA/PCIe Selection	mSATA	Optimal Default, Failsafe Default
	PCIe	
Select mSATA or PCIe function for Mini-Card 2(PCIE2).		

## 3.6 Setup submenu: Security

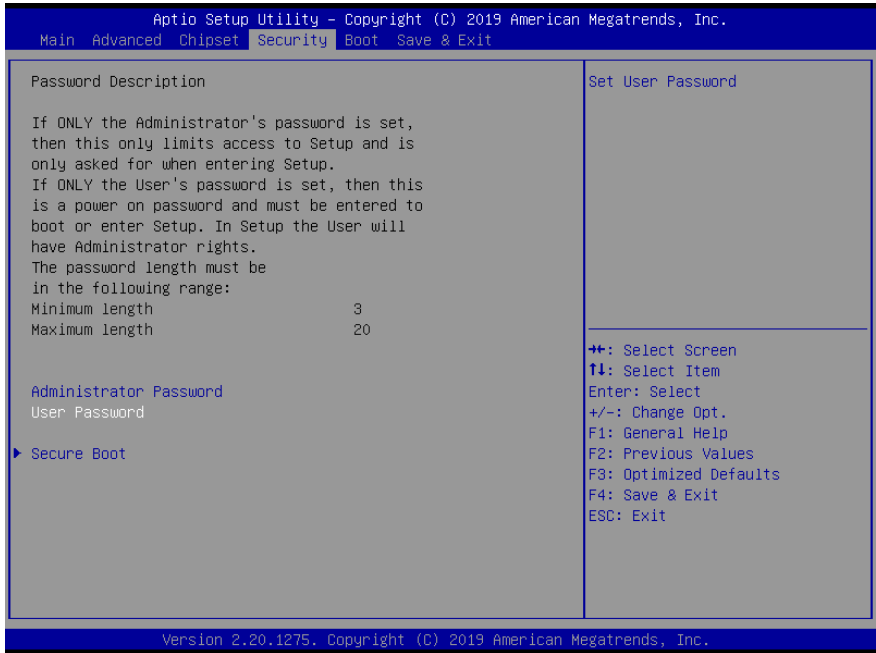

### Change User/Administrator Password

You can set an Administrator Password or User Password. An Administrator Password must be set before you can set a User Password. The password will be required during boot up, or when the user enters the Setup utility. A User Password does not provide access to many of the features in the Setup utility.

Select the password you wish to set, and press Enter. In the dialog box, enter your password (must be between 3 and 20 letters or numbers). Press Enter and retype your password to confirm. Press Enter again to set the password.

### Removing the Password

Select the password you want to remove and enter the current password. At the next dialog box press Enter to disable password protection.

### 3.6.1 Security: Secure Boot

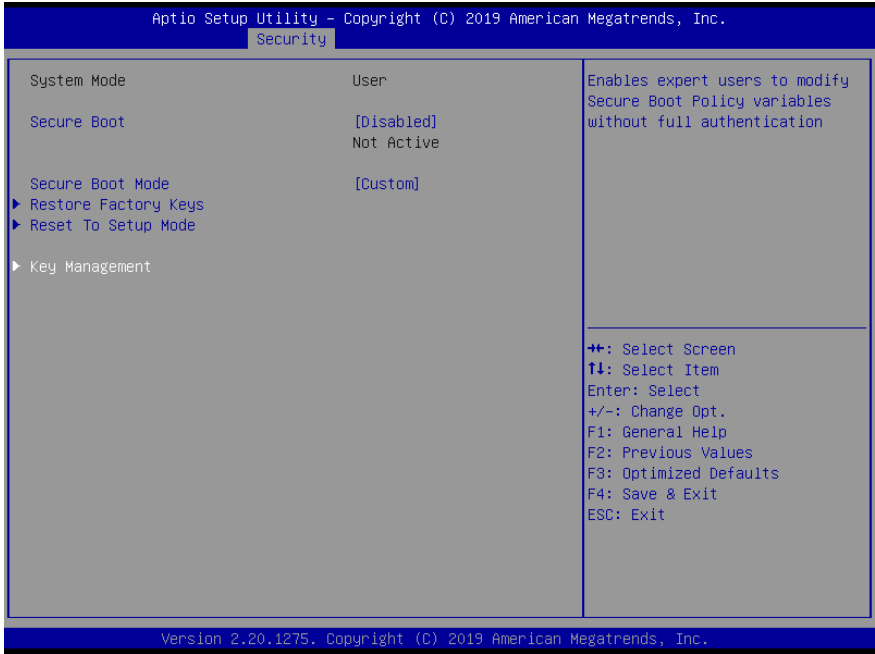

Options Summary		
<b>Secure Boot</b>	Disable	Optimal Default, Failsafe Default
	Enable	
Secure Boot feature is Active if Secure Boot is Enabled, Platform Key (PK) is enrolled and the System mode is in User mode. The mode change requires platform reset.		
<b>Secure Boot Mode</b>	Standard	Optimal Default, Failsafe Default
	Custom	
Secure Boot Mode options: Standard or Custom. In Custom mode, Secure Boot Policy variables can be configured by a physically present user without full authentication.		
<b>Restore Factory Keys</b>	Yes	
	No	
Force System to User Mode. Install factory default Secure Boot key databases		
<b>Key Management</b>		
Enables expert users to modify Secure Boot Policy variables without full authentication		



### 3.6.1.1 Key Management

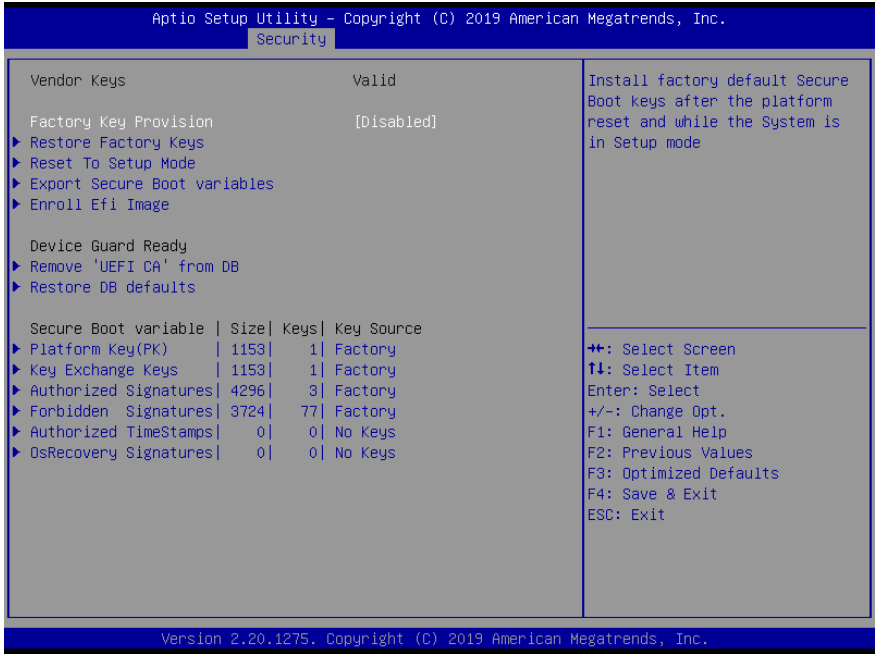

Options Summary		
Factory key Provision	Disabled	Optimal Default, Failsafe Default
	Enabled	
Install factory default Secure Boot keys after the platform reset and while the System is in Setup mode.		
Restore Factory Keys	No	Press 'Yes' to install factory default keys
	Yes	
Force System to User Mode. Install Factory default Secure Boot key databases.		
Reset To Setup Mode	No	Deleting all variables will reset the System to Setup Mode.
	Yes	
Delete all Secure Boot key databases from NVRAM.		
Export Secure Boot variables		
Copy NVRAM content of Secure Boot variables to files in a root folder on a file system device.		

Options Summary	
<b>Enroll Efi Image</b>	
Allow the image to run in Secure Boot mode. Enroll SHA256 Hash Certificate of a PE Image into Authorized Signature Database (db).	

Device Guard Ready		
<b>Remove 'UEFI CA' from SB</b>	No	Press 'Yes' to remove 'UEFI CA' from SB
	Yes	
Device Guard ready system must not list 'Microsoft UEFI CA' Certificate in Authorized Signature database(db).		
<b>Restore DB defaults</b>	No	Press 'Yes' to Restore DB defaults
	Yes	
Restore DB variable to factory defaults.		

Secure Boot variable  Size   Keys#  key Source		
Platform key(PK)   1153   1   No Key	Details	Enroll Factory Defaults or load certificates from a file:  1.Public key Certificate: a)EFI_SIGNATURE_LIST b)EFI_CERT_X509 (DER) c)EFI_CERT_RSA2048 (bin) d)EFI_CERT_SHAXXX  2.Authenticated UEFI Variable 3.EFI PE/COFF Image(SHA256)  Key Source: Factory, External, Mixed
	Export	
	Update	
	Delete	
Key Exchange keys   1153   1   No Key	Details	Enroll Factory Defaults or load certificates from a file:  1.Public key Certificate: a)EFI_SIGNATURE_LIST b)EFI_CERT_X509 (DER) c)EFI_CERT_RSA2048 (bin) d)EFI_CERT_SHAXXX  2.Authenticated UEFI Variable 3.EFI PE/COFF Image(SHA256)  Key Source: Factory, External, Mixed
	Export	
	Update	
	Append	
	Delete	

Table Continues on Next Page...

Secure Boot variable   Size   Keys#   key Source		
Authorized Signatures   4296   3   No Key	Details	Enroll Factory Defaults or load certificates from a file:  1.Public key Certificate: a)EFI_SIGNATURE_LIST b)EFI_CERT_X509 (DER) c)EFI_CERT_RSA2048 (bin) d)EFI_CERT_SHAXXX 2.Authenticated UEFI Variable 3.EFI PE/COFF Image(SHA256)  Key Source: Factory, External, Mixed
	Export	
	Update	
	Append	
	Delete	
Forbidden Signatures   3274   77   No Key	Details	Enroll Factory Defaults or load certificates from a file:  1.Public key Certificate: a)EFI_SIGNATURE_LIST b)EFI_CERT_X509 (DER) c)EFI_CERT_RSA2048 (bin) d)EFI_CERT_SHAXXX 2.Authenticated UEFI Variable 3.EFI PE/COFF Image(SHA256)  Key Source: Factory, External, Mixed
	Export	
	Update	
	Append	
	Delete	
Authorized TimeStamps   0   0   No Key	Update	Enroll Factory Defaults or load certificates from a file:  1.Public key Certificate: a)EFI_SIGNATURE_LIST b)EFI_CERT_X509 (DER) c)EFI_CERT_RSA2048 (bin) d)EFI_CERT_SHAXXX 2.Authenticated UEFI Variable 3.EFI PE/COFF Image(SHA256)  Key Source: Factory, External, Mixed
	Append	

Table Continues on Next Page

Secure Boot variable	Size	Keys#	key Source
OsRecovery Signatures  0   0   No Key	Update		Enroll Factory Defaults or load certificates from a file: 1.Public key Certificate: a)EFI_SIGNATURE_LIST b)EFI_CERT_X509 (DER) c)EFI_CERT_RSA2048 (bin) d)EFI_CERT_SHAXXX 2.Authenticated UEFI Variable 3.EFI PE/COFF Image(SHA256) Key Source: Factory, External, Mixed
	Append		

### 3.7 Setup submenu: Boot

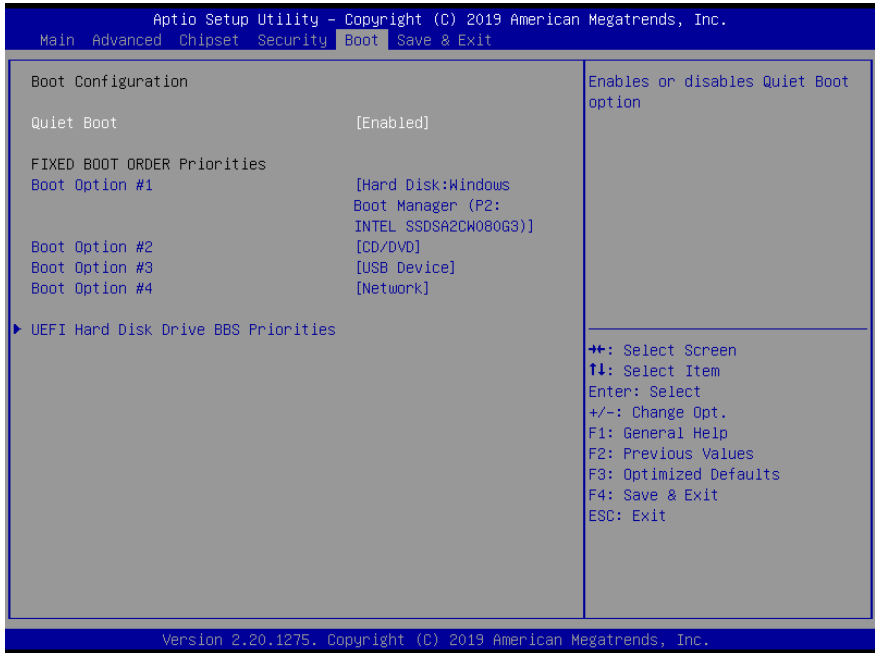

#### Options Summary

Quiet Boot	Disabled	Optimal Default, Failsafe Default
	Enabled	
Enables or disables Quiet Boot option.		

### 3.8 Setup submenu: Save & Exit

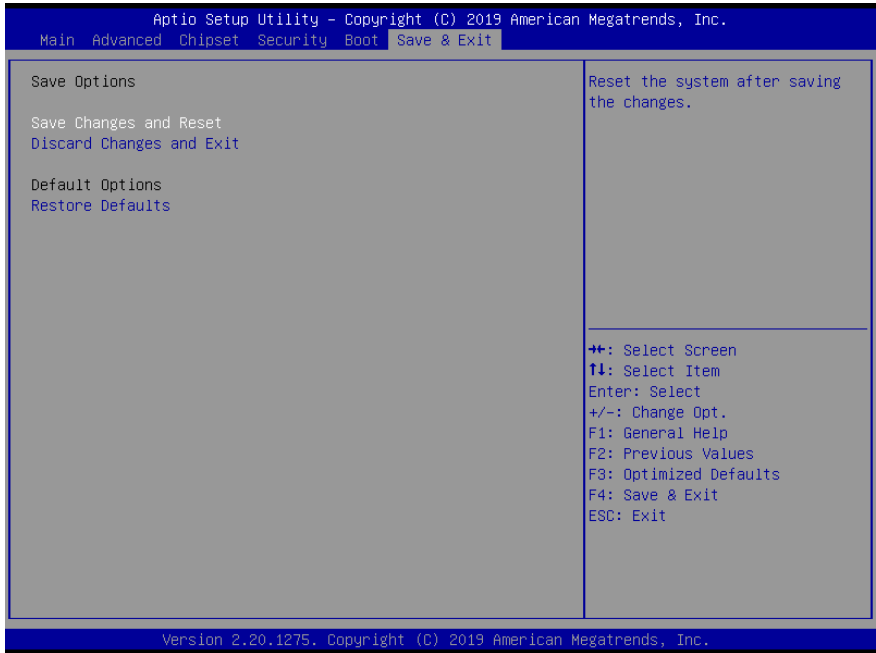

# Chapter 4

---

Drivers Installation

## 4.1 Drivers Download and Installation

---

Drivers for the BOXER-6641 can be downloaded from the product page on the AAEON website by following this link:

<https://www.aaeon.com/en/p/fanless-embedded-box-pc-socket-type-boxer-6641>

Download the driver(s) you need and follow the steps below to install them.

### Step 1 – Install Chipset Driver

1. Open the **Step1 - Chipset** folder and select your OS
2. Run the **SetupChipset.exe** file in the folder
3. Follow the instructions
4. Drivers will be installed automatically

### Step 2 – Install Graphics Driver

1. Open the **Step2 - Graphic** folder and select your OS
2. Run the **igxpin.exe** file in the folder
3. Follow the instructions
4. Drivers will be installed automatically

### Step 3 – Install ME Driver

1. Open the **Step3 - ME** folder and select your OS
2. Run the **SetupME.exe** file in the folder
3. Follow the instructions
4. Drivers will be installed automatically



## Step 4 – LAN

1. Open the **Step4 - LAN** folder and select your OS
2. Run the **PROWinx64\_23.5.2.exe** file in the folder
3. Follow the instructions
4. Drivers will be installed automatically

## Step 5 – Install Audio Driver

1. Open the **Step5 – Audio** folder and select your OS
2. Run the **0008-64bit\_Win7\_Win8\_Win81\_Win10\_R281.exe** file in the folder
3. Follow the instructions
4. Drivers will be installed automatically

## Step 6 – Install Intel RST Driver

1. Open the **Step6 – Intel RST** folder and select your OS
2. Run the **SetupRST.exe** file in the folder
3. Follow the instructions
4. Drivers will be installed automatically

## Step 7 – Install Serial Port Driver (Optional)

1. Open the **Step7 – Serial Port Driver (Optional)** folder
2. Run the **FintekSerial.exe** file in the folder
3. Follow the instructions
4. Drivers will be installed automatically

# Appendix A

---

## Watchdog Timer Programming

## A.1 Watchdog Timer Initial Program

Table 1 : SuperIO relative register table		
	Default Value	Note
Index	0x2E(Note1)	SIO MB PnP Mode Index Register 0x2E or 0x4E
Data	0x2F(Note2)	SIO MB PnP Mode Data Register 0x2F or 0x4F

Table 2 : Watchdog relative register table					
	LDN	Register	BitNum	Value	Note
Timer Counter	0x07(Note3)	0xF6(Note4)		(Note24)	Time of watchdog timer (0~255) This register is byte access
Counting Unit	0x07(Note5)	0xF5(Note6)	3(Note7)	0(Note8)	Select time unit. 0: second 1: minute
Watchdog Enable	0x07(Note9)	0xF5(Note10)	5(Note11)	1(Note12)	0: Disable 1: Enable
Timeout Status	0x07(Note13)	0xF5(Note14)	6(Note15)	1	1: Clear timeout status
Output Mode	0x07(Note16)	0xF5(Note17)	4(Note18)	1(Note19)	Select WDTRST# output mode 0: level 1: pulse
WDTRST output	0x07(Note20)	0xFA(Note21)	0(Note22)	1(Note23)	Enable/Disable time out output via WDTRST# 0: Disable 1: Enable

```

*****
// SuperIO relative definition (Please reference to Table 1)
#define byte SIOIndex //This parameter is represented from Note1
#define byte SIOData //This parameter is represented from Note2
#define void IOWriteByte(byte IOPort, byte Value);
#define byte IOReadByte(byte IOPort);
// Watch Dog relative definition (Please reference to Table 2)
#define byte TimerLDN //This parameter is represented from Note3
#define byte TimerReg //This parameter is represented from Note4
#define byte TimerVal // This parameter is represented from Note24
#define byte UnitLDN //This parameter is represented from Note5
#define byte UnitReg //This parameter is represented from Note6
#define byte UnitBit //This parameter is represented from Note7
#define byte UnitVal //This parameter is represented from Note8
#define byte EnableLDN //This parameter is represented from Note9
#define byte EnableReg //This parameter is represented from Note10
#define byte EnableBit //This parameter is represented from Note11
#define byte EnableVal //This parameter is represented from Note12
#define byte StatusLDN // This parameter is represented from Note13
#define byte StatusReg // This parameter is represented from Note14
#define byte StatusBit // This parameter is represented from Note15
#define byte ModeLDN // This parameter is represented from Note16
#define byte ModeReg // This parameter is represented from Note17
#define byte ModeBit // This parameter is represented from Note18
#define byte ModeVal // This parameter is represented from Note19
#define byte WDRstLDN // This parameter is represented from Note20
#define byte WDRstReg // This parameter is represented from Note21
#define byte WDRstBit // This parameter is represented from Note22
#define byte WDRstVal // This parameter is represented from Note23
*****

```

```
*****  
VOID Main()  
    // Procedure : AaeonWDTConfig  
    // (byte)Timer : Time of WDT timer.(0x00~0xFF)  
    // (boolean)Unit : Select time unit(0: second, 1: minute).  
    AaeonWDTConfig();  
  
    // Procedure : AaeonWDTEnable  
    // This procedure will enable the WDT counting.  
    AaeonWDTEnable();  
}
```

```

*****
// Procedure : AaeonWDTEnable
VOID AaeonWDTEnable (){
    WDTEnableDisable(EnableLDN, EnableReg, EnableBit, 1);
}

// Procedure : AaeonWDTConfig
VOID AaeonWDTConfig (){
    // Disable WDT counting
    WDTEnableDisable(EnableLDN, EnableReg, EnableBit, 0);
    // Clear Watchdog Timeout Status
    WDTClearTimeoutStatus();
    // WDT relative parameter setting
    WDTParameterSetting();
}

VOID WDTEnableDisable(byte LDN, byte Register, byte BitNum, byte Value){
    SIOBitSet(LDN, Register, BitNum, Value);
}

VOID WDTParameterSetting(){
    // Watchdog Timer counter setting
    SIOByteSet(TimerLDN, TimerReg, TimerVal);
    // WDT counting unit setting
    SIOBitSet(UnitLDN, UnitReg, UnitBit, UnitVal);
    // WDT output mode setting, level / pulse
    SIOBitSet(ModeLDN, ModeReg, ModeBit, ModeVal);
    // Watchdog timeout output via WDTRST#
    SIOBitSet(WDTRstLDN, WDTRstReg, WDTRstBit, WDTRstVal);
}

VOID WDTClearTimeoutStatus(){
    SIOBitSet(StatusLDN, StatusReg, StatusBit, 1);
}
*****

```

```

*****
VOID SIOEnterMBPnPMode(){
    IOWriteByte(SIOIndex, 0x87);
    IOWriteByte(SIOIndex, 0x87);
}

VOID SIOExitMBPnPMode(){
    IOWriteByte(SIOIndex, 0xAA);
}

VOID SIOSelectLDN(byte LDN){
    IOWriteByte(SIOIndex, 0x07); // SIO LDN Register Offset = 0x07
    IOWriteByte(SIOData, LDN);
}

VOID SIOBitSet(byte LDN, byte Register, byte BitNum, byte Value){
    Byte TmpValue;

    SIOEnterMBPnPMode();
    SIOSelectLDN(byte LDN);
    IOWriteByte(SIOIndex, Register);
    TmpValue = IOReadByte(SIOData);
    TmpValue &= ~(1 << BitNum);
    TmpValue |= (Value << BitNum);
    IOWriteByte(SIOData, TmpValue);
    SIOExitMBPnPMode();
}

VOID SIOByteSet(byte LDN, byte Register, byte Value){
    SIOEnterMBPnPMode();
    SIOSelectLDN(LDN);
    IOWriteByte(SIOIndex, Register);
    IOWriteByte(SIOData, Value);
    SIOExitMBPnPMode();
}
*****

```

# Appendix B

---

I/O Information















## B.1 I/O Address Map

Input/output (IO)	
[0000000000000000 - 000000000000CF7]	PCI Express Root Complex
[0000000000000020 - 0000000000000021]	Programmable interrupt controller
[0000000000000024 - 0000000000000025]	Programmable interrupt controller
[0000000000000028 - 0000000000000029]	Programmable interrupt controller
[000000000000002C - 000000000000002D]	Programmable interrupt controller
[000000000000002E - 000000000000002F]	Motherboard resources
[0000000000000030 - 0000000000000031]	Programmable interrupt controller
[0000000000000034 - 0000000000000035]	Programmable interrupt controller
[0000000000000038 - 0000000000000039]	Programmable interrupt controller
[000000000000003C - 000000000000003D]	Programmable interrupt controller
[0000000000000040 - 0000000000000043]	System timer
[000000000000004E - 000000000000004F]	Motherboard resources
[0000000000000050 - 0000000000000053]	System timer
[0000000000000061 - 0000000000000061]	Motherboard resources
[0000000000000063 - 0000000000000063]	Motherboard resources
[0000000000000065 - 0000000000000065]	Motherboard resources
[0000000000000067 - 0000000000000067]	Motherboard resources
[0000000000000070 - 0000000000000070]	Motherboard resources
[0000000000000070 - 0000000000000077]	System CMOS/real time clock
[0000000000000080 - 0000000000000080]	Motherboard resources
[0000000000000092 - 0000000000000092]	Motherboard resources
[00000000000000A0 - 00000000000000A1]	Programmable interrupt controller
[00000000000000A4 - 00000000000000A5]	Programmable interrupt controller
[00000000000000A8 - 00000000000000A9]	Programmable interrupt controller
[00000000000000AC - 00000000000000AD]	Programmable interrupt controller
[00000000000000B0 - 00000000000000B1]	Programmable interrupt controller
[00000000000000B2 - 00000000000000B3]	Motherboard resources
[00000000000000B4 - 00000000000000B5]	Programmable interrupt controller
[00000000000000B8 - 00000000000000B9]	Programmable interrupt controller
[00000000000000BC - 00000000000000BD]	Programmable interrupt controller
[00000000000000F0 - 00000000000000F0]	Numeric data processor
[00000000000002E8 - 00000000000002EF]	Communications Port (COM4)
[00000000000002F8 - 00000000000002FF]	Communications Port (COM2)
[00000000000003B0 - 00000000000003BB]	Intel(R) HD Graphics 530
[00000000000003C0 - 00000000000003DF]	Intel(R) HD Graphics 530
[00000000000003E8 - 00000000000003EF]	Communications Port (COM3)
[00000000000003F8 - 00000000000003FF]	Communications Port (COM1)
[00000000000004D0 - 00000000000004D1]	Programmable interrupt controller
[0000000000000680 - 000000000000069F]	Motherboard resources

[0000000000000680 - 00000000000069F]	Motherboard resources
[000000000000800 - 00000000000087F]	Motherboard resources
[000000000000A00 - 000000000000A0F]	Motherboard resources
[000000000000A10 - 000000000000A1F]	Motherboard resources
[000000000000A20 - 000000000000A2F]	Motherboard resources
[000000000000D00 - 000000000000FFFF]	PCI Express Root Complex
[000000000000164E - 000000000000164F]	Motherboard resources
[0000000000001800 - 00000000000018FE]	Motherboard resources
[0000000000001854 - 0000000000001857]	Motherboard resources
[000000000000E000 - 000000000000EFFF]	Intel(R) 100 Series/C230 Series Chipset Family PCI Express Root Port #9 - A118
[000000000000F000 - 000000000000F03F]	Intel(R) HD Graphics 530
[000000000000F000 - 000000000000F03F]	Intel(R) HD Graphics 630
[000000000000F000 - 000000000000F03F]	Intel(R) HD Graphics 630
[000000000000F040 - 000000000000F05F]	Intel(R) 100 Series/C230 Series Chipset Family SMBus - A123
[000000000000F060 - 000000000000F07F]	Standard SATA AHCI Controller
[000000000000F080 - 000000000000F083]	Standard SATA AHCI Controller
[000000000000F090 - 000000000000F097]	Standard SATA AHCI Controller
[000000000000FF00 - 000000000000FFFE]	Motherboard resources
[000000000000FFFF - 000000000000FFFF]	Motherboard resources
[000000000000FFFF - 000000000000FFFF]	Motherboard resources
[000000000000FFFF - 000000000000FFFF]	Motherboard resources

## B.2 IRQ Mapping Chart

---

▼		Interrupt request (IRQ)	
		(ISA) 0x00000000 (00)	System timer
		(ISA) 0x00000003 (03)	Communications Port (COM2)
		(ISA) 0x00000004 (04)	Communications Port (COM1)
		(ISA) 0x00000005 (05)	Intel(R) Ethernet Connection (2) I219-LM
		(ISA) 0x00000005 (05)	Intel(R) HD Graphics 630
		(ISA) 0x00000005 (05)	Intel(R) HD Graphics 630
		(ISA) 0x00000005 (05)	Intel(R) I211 Gigabit Network Connection
		(ISA) 0x00000008 (08)	System CMOS/real time clock
		(ISA) 0x0000000B (11)	Communications Port (COM3)
		(ISA) 0x0000000B (11)	Communications Port (COM4)
		(ISA) 0x0000000D (13)	Numeric data processor
		(ISA) 0x0000000E (14)	Motherboard resources

# Appendix C

---

Digital I/O Ports

## C.1 Electrical Specifications for Digital I/O Ports

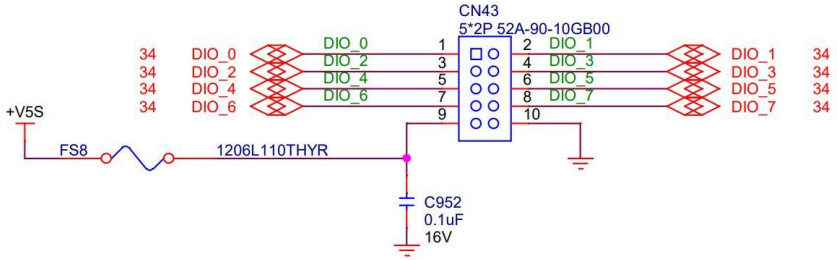

GPIO70	DIO_0
GPIO71	DIO_1
GPIO72	DIO_2
GPIO73	DIO_3
GPIO74	DIO_4
GPIO75	DIO_5
GPIO76	DIO_6
GPIO77	DIO_7

## C.2 DIO Programming

---

BOXER-6641 utilizes FINTEK F81966 chipset as its Digital I/O controller. The following sections detail the procedures to complete its configuration. The AAEON initial DIO program is also attached to help with developing a customized program for your application.

There are three steps to complete the configuration setup:

- Step 1** Enter MB PnP Mode.
- Step 2** Modify the data in the configuration registers.
- Step 3** Exit MB PnP Mode. Undesired results may occur if MB PnP Mode is not exited properly.

## C.2 Digital I/O Register

Table 1: SuperIO relative register table

	Default Value	Note
Index	0x2E(Note1)	SIO MB PnP Mode Index Register 0x2E or 0x4E
Data	0x2F(Note2)	SIO MB PnP Mode Data Register 0x2F or 0x4F

Table 2: Digital Input relative register table

	LDN	Register	BitNum	Value	Note
DIO-1 Pin Status	0x06(Note3)	0x82(Note4)	0(Note5)		GPIO70
DIO-2 Pin Status	0x06(Note6)	0x82(Note7)	1(Note8)		GPIO71
DIO-3 Pin Status	0x06(Note9)	0x82(Note10)	2(Note11)		GPIO72
DIO-4 Pin Status	0x06(Note12)	0x82(Note13)	3(Note14)		GPIO73
DIO-5 Pin Status	0x06(Note15)	0x82(Note16)	4(Note17)		GPIO74
DIO-6 Pin Status	0x06(Note18)	0x82(Note19)	5(Note20)		GPIO75
DIO-7 Pin Status	0x06(Note21)	0x82(Note22)	6(Note23)		GPIO76
DIO-8 Pin Status	0x06(Note24)	0x82(Note25)	7(Note26)		GPIO77

Table 3: Digital Output relative register table

	LDN	Register	BitNum	Value	Note
DIO-1 Output Data	0x06(Note27)	0x81(Note28)	0(Note29)	(Note30)	GPIO70
DIO-2 Output Data	0x06(Note31)	0x81(Note32)	1(Note33)	(Note34)	GPIO71
DIO-3 Output Data	0x06(Note35)	0x81(Note36)	2(Note37)	(Note38)	GPIO72
DIO-4 Output Data	0x06(Note39)	0x81(Note40)	3(Note41)	(Note42)	GPIO73
DIO-5 Output Data	0x06(Note43)	0x81(Note44)	4(Note45)	(Note46)	GPIO74
DIO-6 Output Data	0x06(Note47)	0x81(Note48)	5(Note49)	(Note50)	GPIO75
DIO-7 Output Data	0x06(Note51)	0x81(Note52)	6(Note53)	(Note54)	GPIO76
DIO-8 Output Data	0x06(Note55)	0x81(Note56)	7(Note57)	(Note58)	GPIO77





### C.3 Digital I/O Sample Program

---

```
*****
// SuperIO relative definition (Please reference to Table 1)
#define byte SIOIndex //This parameter is represented from Note1
#define byte SIOData //This parameter is represented from Note2
#define void IOWriteByte(byte IOPort, byte Value);
#define byte IOReadByte(byte IOPort);
// Digital Input Status relative definition (Please reference to Table 2)
#define byte DInput1LDN // This parameter is represented from Note3
#define byte DInput1Reg // This parameter is represented from Note4
#define byte DInput1Bit // This parameter is represented from Note5
#define byte DInput2LDN // This parameter is represented from Note6
#define byte DInput2Reg // This parameter is represented from Note7
#define byte DInput2Bit // This parameter is represented from Note8
#define byte DInput3LDN // This parameter is represented from Note9
#define byte DInput3Reg // This parameter is represented from Note10
#define byte DInput3Bit // This parameter is represented from Note11
#define byte DInput4LDN // This parameter is represented from Note12
#define byte DInput4Reg // This parameter is represented from Note13
#define byte DInput4Bit // This parameter is represented from Note14
#define byte DInput5LDN // This parameter is represented from Note15
#define byte DInput5Reg // This parameter is represented from Note16
#define byte DInput5Bit // This parameter is represented from Note17
#define byte DInput6LDN // This parameter is represented from Note18
#define byte DInput6Reg // This parameter is represented from Note19
#define byte DInput6Bit // This parameter is represented from Note20
#define byte DInput7LDN // This parameter is represented from Note21
#define byte DInput7Reg // This parameter is represented from Note22
#define byte DInput7Bit // This parameter is represented from Note23
#define byte DInput8LDN // This parameter is represented from Note24
#define byte DInput8Reg // This parameter is represented from Note25
#define byte DInput8Bit // This parameter is represented from Note26
*****
```

```

*****
// Digital Output control relative definition (Please reference to Table 3)
#define byte DOutput1LDN // This parameter is represented from Note27
#define byte DOutput1Reg // This parameter is represented from Note28
#define byte DOutput1Bit // This parameter is represented from Note29
#define byte DOutput1Val // This parameter is represented from Note30
#define byte DOutput2LDN // This parameter is represented from Note31
#define byte DOutput2Reg // This parameter is represented from Note32
#define byte DOutput2Bit // This parameter is represented from Note33
#define byte DOutput2Val // This parameter is represented from Note34
#define byte DOutput3LDN // This parameter is represented from Note35
#define byte DOutput3Reg // This parameter is represented from Note36
#define byte DOutput3Bit // This parameter is represented from Note37
#define byte DOutput3Val // This parameter is represented from Note38
#define byte DOutput4LDN // This parameter is represented from Note39
#define byte DOutput4Reg // This parameter is represented from Note40
#define byte DOutput4Bit // This parameter is represented from Note41
#define byte DOutput4Val // This parameter is represented from Note42
#define byte DOutput5LDN // This parameter is represented from Note43
#define byte DOutput5Reg // This parameter is represented from Note44
#define byte DOutput5Bit // This parameter is represented from Note45
#define byte DOutput5Val // This parameter is represented from Note46
#define byte DOutput6LDN // This parameter is represented from Note47
#define byte DOutput6Reg // This parameter is represented from Note48
#define byte DOutput6Bit // This parameter is represented from Note49
#define byte DOutput6Val // This parameter is represented from Note50
#define byte DOutput7LDN // This parameter is represented from Note51
#define byte DOutput7Reg // This parameter is represented from Note52
#define byte DOutput7Bit // This parameter is represented from Note53
#define byte DOutput7Val // This parameter is represented from Note54
#define byte DOutput8LDN // This parameter is represented from Note55
#define byte DOutput8Reg // This parameter is represented from Note56
#define byte DOutput8Bit // This parameter is represented from Note57
#define byte DOutput8Val // This parameter is represented from Note58
*****

```

```
*****
VOID Main(){
    Boolean PinStatus ;

    // Procedure : AaeonReadPinStatus
    // Input :
    //     Example, Read Digital I/O Pin 3 status
    // Output :
    //     InputStatus :
    //         0: Digital I/O Pin level is low
    //         1: Digital I/O Pin level is High
    PinStatus = AaeonReadPinStatus(DInput3LDN, DInput3Reg, DInput3Bit);

    // Procedure : AaeonSetOutputLevel
    // Input :
    //     Example, Set Digital I/O Pin 6 level
    AaeonSetOutputLevel(DOutput6LDN, DOutput6Reg, DOutput6Bit,
DOutput6Val);
}
*****
```

```
*****
Boolean  AaeonReadPinStatus(byte LDN, byte Register, byte BitNum){
    Boolean PinStatus ;

    PinStatus = SIOBitRead(LDN, Register, BitNum);
    Return PinStatus ;
}
VOID  AaeonSetOutputLevel(byte LDN, byte Register, byte BitNum, byte Value){
    ConfigToOutputMode(LDN, Register, BitNum);
    SIOBitSet(LDN, Register, BitNum, Value);
}
*****
```

```

*****
VOID  SIOEnterMBPnPMode(){
    IOWriteByte(SIOIndex, 0x87);
    IOWriteByte(SIOIndex, 0x87);
}

VOID  SIOExitMBPnPMode(){
    IOWriteByte(SIOIndex, 0xAA);
}

VOID  SIOSelectLDN(byte LDN){
    IOWriteByte(SIOIndex, 0x07); // SIO LDN Register Offset = 0x07
    IOWriteByte(SIOData, LDN);
}

VOID  SIOBitSet(byte LDN, byte Register, byte BitNum, byte Value){
    Byte TmpValue;

    SIOEnterMBPnPMode();
    SIOSelectLDN(byte LDN);
    IOWriteByte(SIOIndex, Register);
    TmpValue = IOReadByte(SIOData);
    TmpValue &= ~(1 << BitNum);
    TmpValue |= (Value << BitNum);
    IOWriteByte(SIOData, TmpValue);
    SIOExitMBPnPMode();
}

VOID  SIOByteSet(byte LDN, byte Register, byte Value){
    SIOEnterMBPnPMode();
    SIOSelectLDN(LDN);
    IOWriteByte(SIOIndex, Register);
    IOWriteByte(SIOData, Value);
    SIOExitMBPnPMode();
}
*****

```

```
*****
Boolean  SIOBitRead(byte LDN, byte Register, byte BitNum){
    Byte TmpValue;

    SIOEnterMBPnPMode();
    SIOSelectLDN(LDN);
    IOWriteByte(SIOIndex, Register);
    TmpValue = IOReadByte(SIOData);
    TmpValue &= (1 << BitNum);
    SIOExitMBPnPMode();
    If(TmpValue == 0)
        Return 0;
    Return 1;
}
VOID  ConfigToOutputMode(byte LDN, byte Register, byte BitNum){
    Byte TmpValue, OutputEnableReg;

    OutputEnableReg = Register-1;
    SIOEnterMBPnPMode();
    SIOSelectLDN(LDN);
    IOWriteByte(SIOIndex, OutputEnableReg);
    TmpValue = IOReadByte(SIOData);
    TmpValue |= (1 << BitNum);
    IOWriteByte(SIOData, OutputEnableReg);
    SIOExitMBPnPMode();
}
*****
```