

BOXER-6639

Fanless Embedded Box PC

User's Manual 4th Ed

Copyright Notice

This document is copyrighted, 2017. All rights are reserved. The original manufacturer reserves the right to make improvements to the products described in this manual at any time without notice.

No part of this manual may be reproduced, copied, translated, or transmitted in any form or by any means without the prior written permission of the original manufacturer. Information provided in this manual is intended to be accurate and reliable. However, the original manufacturer assumes no responsibility for its use, or for any infringements upon the rights of third parties that may result from its use.

The material in this document is for product information only and is subject to change without notice. While reasonable efforts have been made in the preparation of this document to assure its accuracy, AAEMON assumes no liabilities resulting from errors or omissions in this document, or from the use of the information contained herein.

AAEMON reserves the right to make changes in the product design without notice to its users.

Acknowledgement

All other products' name or trademarks are properties of their respective owners.

- Microsoft Windows® is a registered trademark of Microsoft Corp.
- Intel®, Platium®, Celeron®, and Xeon® are registered trademarks of Intel Corporation
- Atom™ is a trademark of Intel Corporation
- ITE is a trademark of Integrated Technology Express, Inc.
- IBM, PC/AT, PS/2, and VGA are trademarks of International Business Machines Corporation.

All other product names or trademarks are properties of their respective owners.

Packing List

Before setting up your product, please make sure the following items have been shipped:

Item	Quantity
● BOXER-6639	1
● Wallmount bracket	2
● Screw Package	1
● Thermal Pad	1
● Phoenix power connector	1
● Product DVD with User's Manual (in pdf) and drivers	1

If any of these items are missing or damaged, please contact your distributor or sales representative immediately.

About this Document

This User's Manual contains all the essential information, such as detailed descriptions and explanations on the product's hardware and software features (if any), its specifications, dimensions, jumper/connector settings/definitions, and driver installation instructions (if any), to facilitate users in setting up their product.

Users may refer to the AAEON.com for the latest version of this document.

Safety Precautions

Please read the following safety instructions carefully. It is advised that you keep this manual for future references

1. All cautions and warnings on the device should be noted.
2. Make sure the power source matches the power rating of the device.
3. Position the power cord so that people cannot step on it. Do not place anything over the power cord.
4. Always completely disconnect the power before working on the system's hardware.
5. No connections should be made when the system is powered as a sudden rush of power may damage sensitive electronic components.
6. If the device is not to be used for a long time, disconnect it from the power supply to avoid damage by transient over-voltage.
7. Always disconnect this device from any power supply before cleaning.
8. While cleaning, use a damp cloth instead of liquid or spray detergents.
9. Make sure the device is installed near a power outlet and is easily accessible.
10. Keep this device away from humidity.
11. Place the device on a solid surface during installation to prevent falls.
12. Do not cover the openings on the device to ensure optimal heat dissipation.
13. Watch out for high temperatures when the system is running.
14. Do not touch the heat sink or heat spreader when the system is running
15. Never pour any liquid into the openings. This could cause fire or electric shock.
16. As most electronic components are sensitive to static electrical charge, be sure to ground yourself to prevent static charge when installing the internal components. Use a grounding wrist strap and contain all electronic components in any static-shielded containers.

17. If any of the following situations arises, please contact our service personnel:
 - i. Damaged power cord or plug
 - ii. Liquid intrusion to the device
 - iii. Exposure to moisture
 - iv. Device is not working as expected or in a manner as described in this manual
 - v. The device is dropped or damaged
 - vi. Any obvious signs of damage displayed on the device
18. Do not leave this device in an uncontrolled environment with temperatures beyond the device's permitted storage temperatures (see chapter 1) to prevent damage.
19. Do NOT disassemble the motherboard so as not to damage the system or void your warranty.
20. If the thermal pad had been damaged, please contact AAEON's salesperson to purchase a new one. Do NOT use those of other brands.
21. The Hex Cylinder Coppers on the front panel are not removable.
22. Repeatedly assemble and disassemble the system may cause damages to the exterior paint and surface and screw holes.
23. Use the right size screwdriver.
24. Use the screwdriver correctly to remove screws from the system.

FCC Statement

Warning!



This device complies with Part 15 FCC Rules. Operation is subject to the following two conditions: (1) this device may not cause harmful interference, and (2) this device must accept any interference received including interference that may cause undesired operation.

Caution:

There is a danger of explosion if the battery is incorrectly replaced. Replace only with the same or equivalent type recommended by the manufacturer. Dispose of used batteries according to the manufacturer's instructions and your local government's recycling or disposal directives.

Attention:

Il y a un risque d'explosion si la batterie est remplacée de façon incorrecte. Ne la remplacer qu'avec le même modèle ou équivalent recommandé par le constructeur. Recycler les batteries usées en accord avec les instructions du fabricant et les directives gouvernementales de recyclage.

China RoHS Requirements (CN)

产品中有毒有害物质或元素名称及含量

AAEON Embedded Box PC/ Industrial System

部件名称	有毒有害物质或元素					
	铅 (Pb)	汞 (Hg)	镉 (Cd)	六价铬 (Cr(VI))	多溴联苯 (PBB)	多溴二苯醚 (PBDE)
印刷电路板 及其电子组件	○	○	○	○	○	○
外部信号 连接器及线材	○	○	○	○	○	○
外壳	○	○	○	○	○	○
中央处理器 与内存	○	○	○	○	○	○
硬盘	○	○	○	○	○	○
电源	○	○	○	○	○	○
<p>○: 表示该有毒有害物质在该部件所有均质材料中的含量均在 SJ/T 11363-2006 标准规定的限量要求以下。</p> <p>X: 表示该有毒有害物质至少在该部件的某一均质材料中的含量超出 SJ/T 11363-2006 标准规定的限量要求。</p> <p>备注: 一、此产品所标示之环保使用期限, 系指在一般正常使用状况下。 二、上述部件物质中央处理器、内存、硬盘、电源为选购品。</p>						

China RoHS Requirement (EN)

Poisonous or Hazardous Substances or Elements in Products
 AAEON Embedded Box PC/ Industrial System

Component	Poisonous or Hazardous Substances or Elements					
	Lead (Pb)	Mercury (Hg)	Cadmium (Cd)	Hexavalent Chromium (Cr(VI))	Polybrominated Biphenyls (PBB)	Polybrominated Diphenyl Ethers (PBDE)
PCB & Other Components	○	○	○	○	○	○
Wires & Connectors for External Connections	○	○	○	○	○	○
Chassis	○	○	○	○	○	○
CPU & RAM	○	○	○	○	○	○
Hard Disk	○	○	○	○	○	○
PSU	○	○	○	○	○	○
<p>O: The quantity of poisonous or hazardous substances or elements found in each of the component's parts is below the SJ/T 11363-2006-stipulated requirement.</p> <p>X: The quantity of poisonous or hazardous substances or elements found in at least one of the component's parts is beyond the SJ/T 11363-2006-stipulated requirement.</p> <p>Note: The Environment Friendly Use Period as labeled on this product is applicable under normal usage only</p>						

Table of Contents

- Chapter 1 - Product SpecificationsError! Bookmark not defined.**
 - 1.1 Specifications..... **Error! Bookmark not defined.**
- Chapter 2 – Hardware Information 4**
 - 2.1 Dimensions 5
 - 2.2 Jumpers and Connectors7
 - 2.3 List of Jumpers10
 - 2.3.1 Auto Power Button (JP19).....10
 - 2.3.2 Clear CMOS Jumper (JP24)10
 - 2.4 List of Connectors11
 - 2.4.1 VGA Port.....12
 - 2.4.2 DC-IN12
 - 2.4.3 HDMI Port (HDMI1/HDMI2)13
 - 2.4.4 DIO Port.....13
 - 2.4.5 LAN + USB 3.015
 - 2.4.6 Remote Power Button.....16
 - 2.4.7 CFast16
 - 2.4.8 SATA Power Connector 1~217
 - 2.4.9 SATA Signal Connector 1~217
 - 2.4.10 COM 1/2/3/4/5/618
 - 2.4.11 Mini Card Connector with Onboard SIM.....19
 - 2.5 CPU Installation.....21
 - 2.6 DDR4 Memory Module Installation.....23
 - 2.7 2.5" SATA Drive Installation.....25
 - 2.8 Power Connector Installation.....26
- Chapter 3 - AMI BIOS Setup.....27**
 - 3.1 System Test and Initialization28

3.2	AMI BIOS Setup.....	29
3.3	Setup Submenu: Main.....	30
3.4	Setup Submenu: Advanced	31
3.4.1	Advanced: CPU Configuration.....	32
3.4.2	Advanced: SATA Configuration.....	33
3.4.3	Advanced: PCH-FW Configuration.....	34
3.4.4	Advanced: SIO Configuration	36
3.4.4.1	SIO Configuration: Serial Port 1 Configuration	37
3.4.4.2	SIO Configuration: Serial Port 2 Configuration.....	38
3.4.4.3	SIO Configuration: Serial Port 3 Configuration.....	39
3.4.4.4	SIO Configuration: Serial Port 4 Configuration.....	40
3.4.4.5	SIO Configuration: Serial Port 5 Configuration.....	41
3.4.4.6	SIO Configuration: Serial Port 6 Configuration.....	42
3.4.5	Advanced: Hardware Monitor.....	43
3.4.6	Advanced: USB Configuration	44
3.4.7	Advanced: Digital IO Port Configuration.....	45
3.4.8	Advanced: Power Management	50
3.5	Setup submenu: Chipset.....	51
3.5.1	Chipset: System Agent (SA) Configuration	52
3.5.1.1	System Agent (SA) Configuration: Graphics Configuration	53
3.5.2	Chipset: PCH-IO Configuration	54
3.6	Setup submenu: Security	56
3.7	Setup submenu: Boot.....	57
3.7.1	Boot: BBS Priorities	58
3.8	Setup submenu: Save & Exit.....	59
Chapter 4 – Drivers Installation		60
4.1	Product CD/DVD.....	61
Appendix A - Watchdog Timer Programming.....		65

A.1	Watchdog Timer Initial Program.....	66
Appendix C - I/O Information.....		68
B.1	I/O Address Map.....	69
B.2	Memory Address Map.....	71
B.3	IRQ Mapping Chart.....	73
Appendix C - Digital I/O Information.....		83
C.1	DIO Programming.....	84
C.2	DIO Register.....	85
C.3	DIO Sample Program.....	87

Chapter 1

Product Specifications

1.1 Specifications

System

- **Processor**
Intel® Core™ i7-6700TE, 2.4 GHz
Intel® Core™ i5-6500TE, 2.3 GHz
Intel® Core™ i3-6100TE, 2.7 GHz
- **System Memory**
DDR4 1866/2133 SODIMM slot x 2, up to 32 GB, ECC or Non-ECC support
- **Display**
VGA x 1
HDMI x 2
- **Ethernet**
Intel® I210, 10/100/1000Base-TX x 3
- **Storage Device**
CFast™, SATA HDD/SSD (Optional x2)
- **Serial Port**
RS-232/422/485 x 6
- **USB**
USB 3.0 x 4
USB 2.0 x 2
- **LED Indicator**
Power LED x 1
Hard Disk Active LED x 1
- **Expansion Slot**
Full-size Mini-Card x 2
SIM Slot x 1
- **OS Support**
Windows® 10 (64-bit)
Windows® 8.1 (64-bit)
WES7/WES8/Win 10 IOT

Mechanical

- **Construction**
Rugged aluminum extrusion and heavy-duty steel
- **Mounting**
Wallmount

- Dimension (W x H x D) DIN rail (optional)
264.2 x 66.5 x 156.2 mm (10.4 x 2.6 x 6.1")
- Gross Weight 3.5 kg (7.7 lb)
- Net Weight 3.0 kg (6.6 lb)

Environmental

- Operating Temperature Ambient with Airflow
-20°C ~ 55°C (according to IEC68-2-14 with 0.5 m/s AirFlow ; with industrial devices)
- Storage Temperature -45°C ~ 80°C (-49°F ~ 185°F)
- Storage Humidity 5~95% @ 40°C, non-condensing
- Anti-Vibration 2 G_{rms}/ 5~500Hz/ operation – CFast™
1 G_{rms}/ 5~500Hz/ operation – HDD
- EMC CE/FCC Class A

Power Supply

- DC Input 9 – 36V with 3-pin terminal block

Chapter 2

Hardware Information

A2

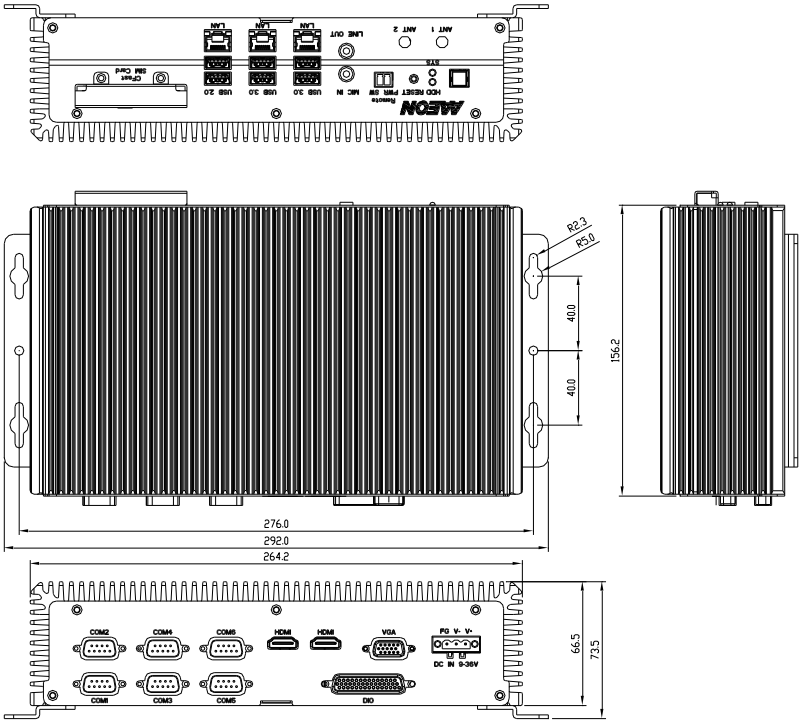

2.2 Jumpers and Connectors

Component Side

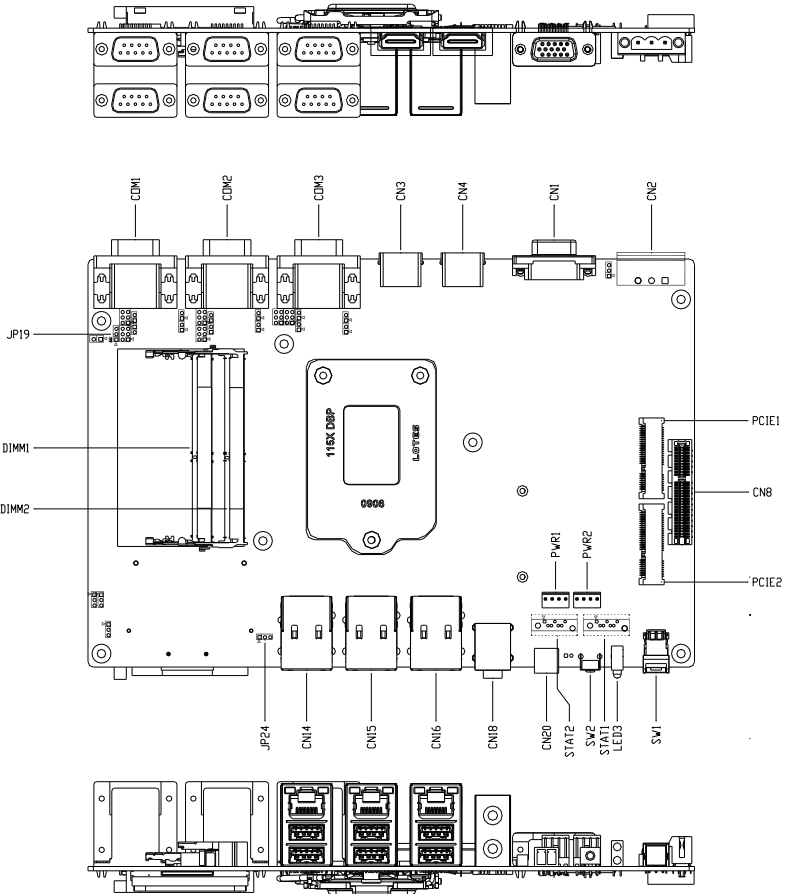

Solder Side

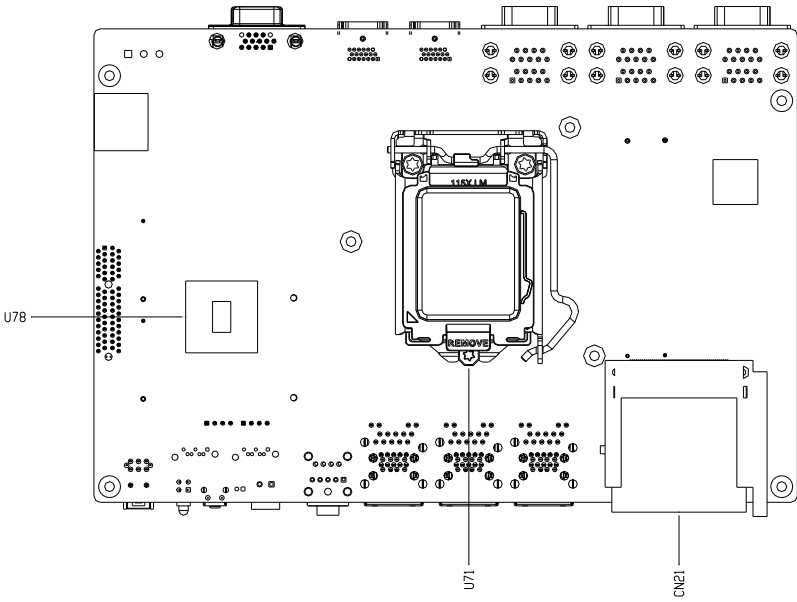

A1

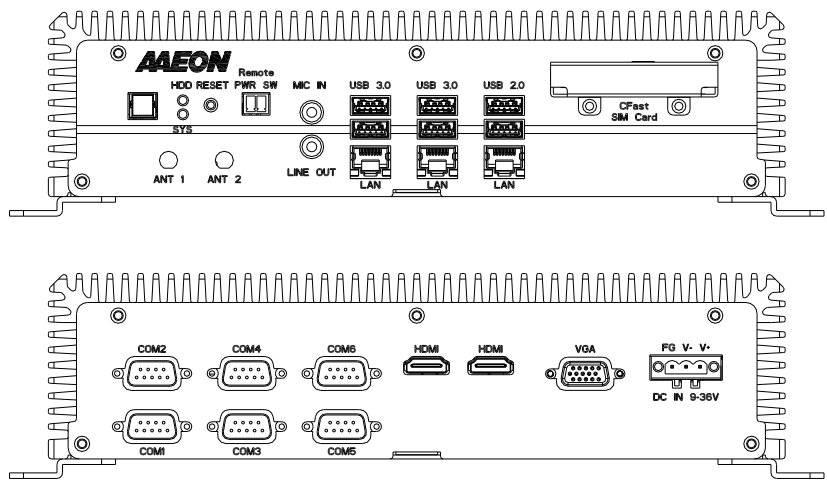

A2

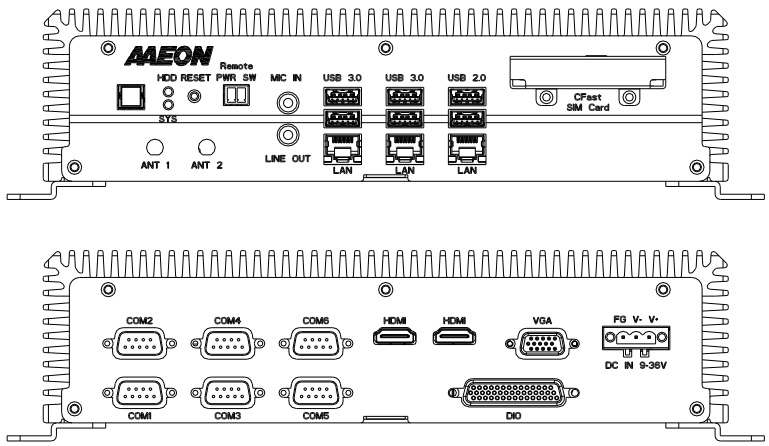

2.3 List of Jumpers

Please refer to the table below for all of the system's jumpers that you can configure for your application

Label	Function
JP4	RS-232/ 422/ 485 selection for COM1 port
JP5	RS-232/ 422/ 485 selection for COM6 port
JP6	RS-232/ 422/ 485 selection for COM4 port
JP7	RS-232/ 422/ 485 selection for COM3 port
JP17	RS-232/ 422/ 485 selection for COM2 port
JP18	RS-232/ 422/ 485 selection for COM5 port
JP19	AT/ATX mode select
JP24	Clear CMOS

2.3.1 Auto Power Button (JP19)

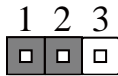

Disable

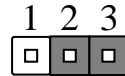

Enable (Default)

2.3.2 Clear CMOS Jumper (JP24)

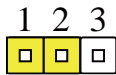

Normal (Default)

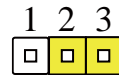

Clear CMOS

2.4 List of Connectors

Please refer to the table below for all of the system's connectors that you can configure for your application

Label	Function
VGA	DB-15 CRT port
DC-IN	9~36V DC-IN connector
HDMI1	HDMI connector
HDMI2	HDMI connector
DIO	8- bit Digital Input & Output connector
USB 3.0 Port 1~4	USB 3.0 Port
USB 2.0 Port 1~2	USB 2.0 Port
LAN Port 1~3	RJ45 10/100/1000Mbps LAN connector
Audio Jack	3.5mm Audio Line-out connector
Remote Power Button	2-pin Remote power on/off button
CFast	CFast slot connector
Power Switch	Power on/off switch
Reset Switch	H/W Reset switch
SATA Power Connector 1~2	SATA Storage power connector
SATA Signal Connector 1~2	SATA Storage signal connector
COM 1/2/3/4/5/6	DB9 RS232/422/485 connector
MiniCard 1~2	PCI Express Minicard slot
SIM Slot	SIM card connector
DDR4 SODIMM Slot 1~2	DDR4 260-pin memory bank

2.4.1 VGA Port

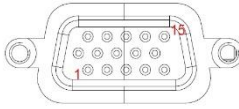

Pin	Signal	Pin	Signal
1	Red	2	Green
3	Blue	4	NC
5	GND	6	GND
7	GND	8	GND
9	VGA_VCC	10	GND
11	NC	12	DDC_DATA
13	VGA_HSYNC	14	VGA_VSYNC
15	DDC_CLK		

2.4.2 DC-IN

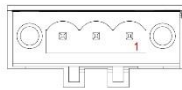

Pin	Signal	Pin	Signal
1	PWR_IN	2	GND
3	NC		

2.4.3 HDMI Port (HDMI1/HDMI2)

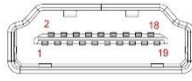

Pin	Signal	Pin	Signal
1	HDMI_DATA2_P	2	GND
3	HDMI_DATA2_N	4	HDMI_DATA1_P
5	GND	6	HDMI_DATA1_N
7	HDMI_DATA0_P	8	GND
9	HDMI_DATA0_N	10	HDMI_CLK_P
11	GND	12	HDMI_CLK_N
13	NC	14	NC
15	HDMI_SCL	16	HDMI_SDA
17	GND	18	HDMI_PWR
19	HDMI_HDP		

2.4.4 DIO Port

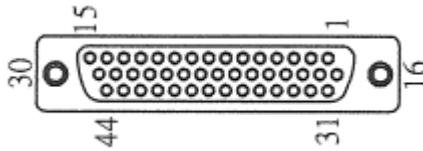

Pin	Signal	Pin	Signal
1	DIO1	2	DIO2
3	DIO3	4	DIO4
5	DIO5	6	DIO6
7	DIO7	8	DIO8

Pin	Signal	Pin	Signal
9	DIO9	10	DIO10
11	DIO11	12	DIO12
13	DIO13	14	DIO14
15	DIO15	16	DIO16
17	DIO17	18	DIO18
19	DIO19	20	DIO20
21	DIO21	22	DIO22
23	DIO23	24	DIO24
25	DIO25	26	DIO26
27	DIO27	28	DIO28
29	DIO29	30	DIO30
31	DIO31	32	DIO32
33	DIO33	34	DIO34
35	+3.3V	36	GND
37	+3.3V	38	GND
39	+3.3V	40	GND
41	NC	42	NC
43	NC	44	NC

2.4.5 LAN + USB 3.0

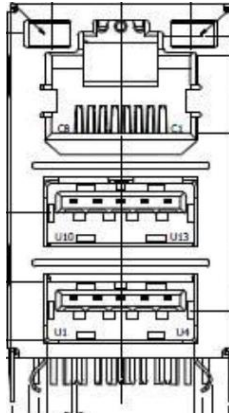

Pin	Signal	Pin	Signal
C1	MDI0+	U2	MDI0-
C3	MDI1+	U4	MDI2+
C5	MDI2-	U6	MDI1-
C7	MDI3+	U8	MDI3-
U1	VBUS_1	U10	VBUS_2
U2	(A)D-	U11	(B)D-
U3	(A)D+	U12	(B)D+
U4	GND	U13	GND
U5	(A)SSRX-	U14	(B)SSRX-
U6	(A)SSRX+	U15	(B)SSRX+
U7	GND	U16	GND
U8	(A)SSTX-	U17	(B)SSTX-
U9	(A)SSTX+	U18	(B)SSTX+

2.4.6 Remote Power Button



Pin	Signal	Pin	Signal
1	PANSWH#	2	GND

2.4.7 CFast

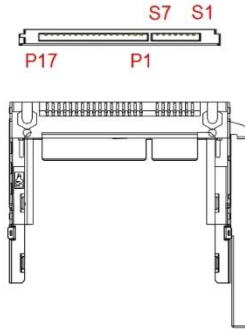

Pin	Signal	Pin	Signal
S1	GND	S2	TX+
S3	TX-	S4	GND
S5	RX-	S6	RX+
S7	GND		
P1	CD	P2	GND
P3	NC	P4	NC
P5	NC	P6	NC
P7	GND	P8	NC
P9	NC	P10	NC
P11	NC	P12	NC

Pin	Signal	Pin	Signal
P13	+3.3V	P14	+3.3V
P15	GND	P16	GND
P17	NC		

2.4.8 SATA Power Connector 1~2

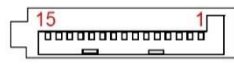

Pin	Pin Name	level
1	+12V	12V
2	GND	GND
3	GND	GND
4	+5V	5V

2.4.9 SATA Signal Connector 1~2

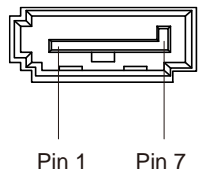

Pin	Pin name	Signal Type	Signal Level
1	GND	GND	-
2	SATA_TX+	DIFF	-
3	SATA_TX-	DIFF	-
4	GND	GND	-
5	SATA_RX-	DIFF	-
6	SATA_RX+	DIFF	-

Pin	Pin name	Signal Type	Signal Level
7	GND	GND	-

2.4.10 COM 1/2/3/4/5/6

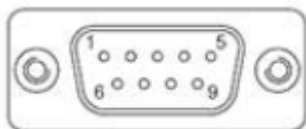

Pin	RS-232	RS-422	RS-485
1	DCD	TX-	DATA-
2	RXD	TX+	DATA+
3	TXD	RX+	NC
4	DTR	RX-	NC
5	GND	NC	NC
6	DSR	NC	NC
7	RTS	NC	NC
8	CTS	NC	NC
9	RI	NC	NC

2.4.11 Mini Card Connector with Onboard SIM



Pin	Signal	Pin	Signal
1	PCIE_WAKE#	2	+V3.3A
3	NC	4	GND
5	NC	6	+1.5V
7	PCIE_CLK_REQ#	8	UIM_PWR
9	GND	10	UIM_DATA
11	PCIE_REF_CLK-	12	UIM_CLK
13	PCIE_REF_CLK+	14	UIM_RST
15	GND	16	UIM_VPP
17	NC	18	GND
19	NC	20	W_DISABLE#
21	GND	22	PCIE_RST#
23	PCIE_RX-	24	+V3.3A
25	PCIE_RX+	26	GND
27	GND	28	+1.5V
29	GND	30	SMB_CLK
31	PCIE_TX-	32	SMB_DATA

Pin	Signal	Pin	Signal
33	PCIE_TX+	34	GND
35	GND	36	USB_D-
37	GND	38	USB_D+
39	+V3.3A	40	GND
41	+V3.3A	42	NC
43	GND	44	NC
45	NC	46	NC
47	NC	48	+1.5V
49	NC	50	GND
51	NC	52	+V3.3A

2.5 CPU Installation

- Turn off the system, unplug the power cord and make sure the system is off.
- Have Intel Skylake-S FCLGA1151 Processor (Max. TDP 35W) ready.



Step 1: Remove the screws as instructed below and remove the heatsink.

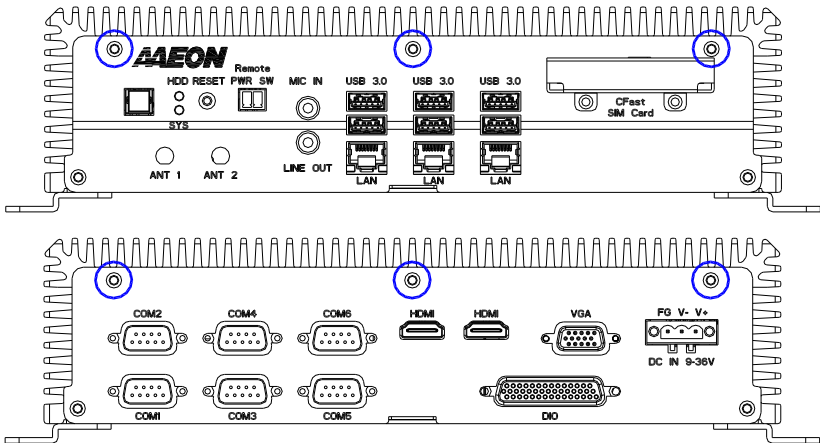

Step 2: Install the CPU into the socket and place the thermal pad onto it.

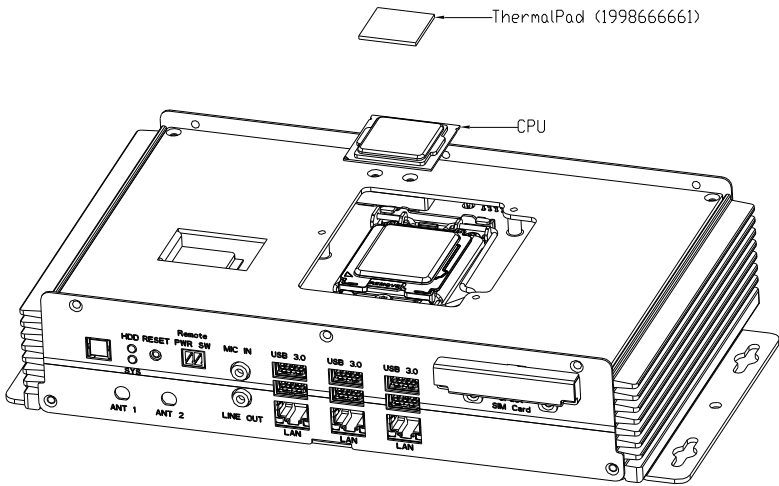

Step 3: Place the heatsink back on and fasten the screws as instructed below.

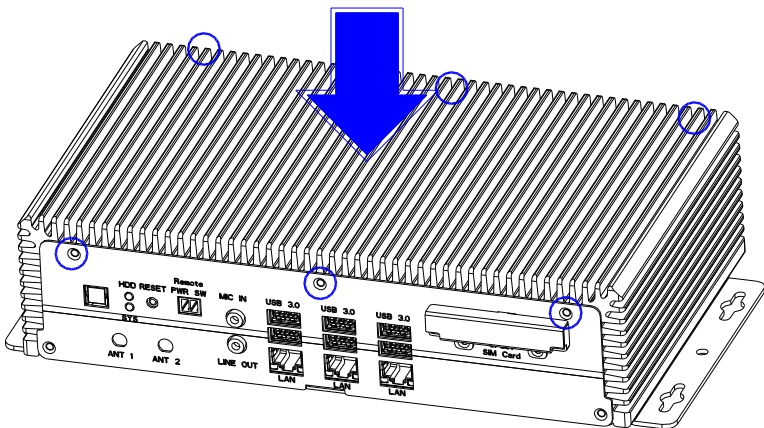

2.6 DDR4 Memory Module Installation

- Turn off the system, unplug the power cord to make sure the system is power off.

Step 1: Turn the system upside down. Remove the screws as instructed below and the bottom cover.

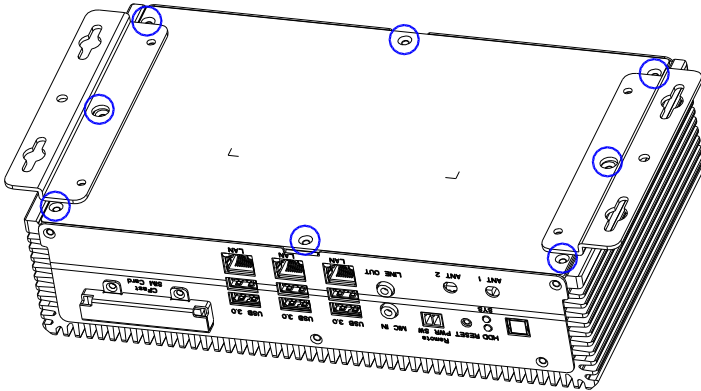

Step 2: Place the thermal pads onto the RAM modules as instructed below..

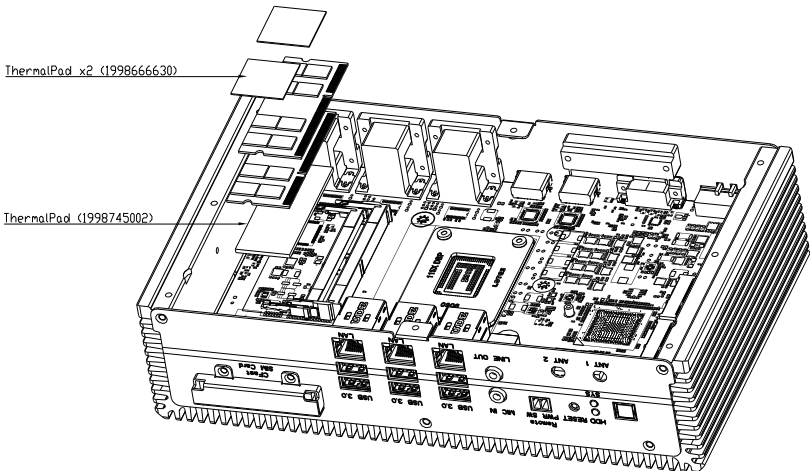

Step 3: After the RAM modules are installed, put the bracket onto the RAM and secure the screws as instructed below.

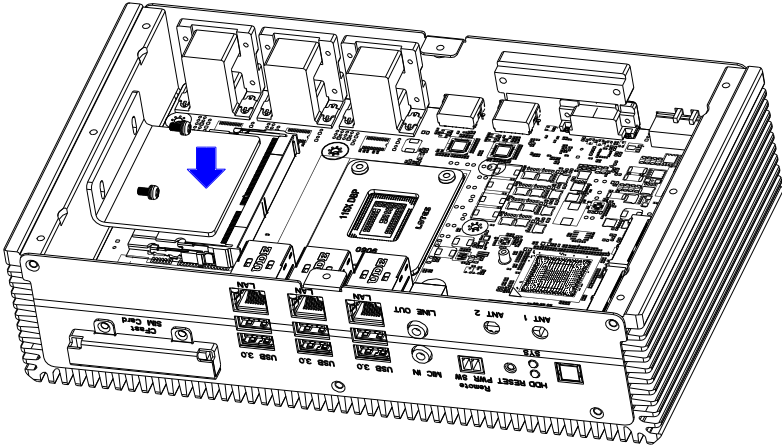

2.7 2.5" SATA Drive Installation

- Turn off the system, unplug the power cord to make sure the system is power off.

Step 1: Use the HDD screws provided to assemble 2.5" SATA drive with the HDD Bracket

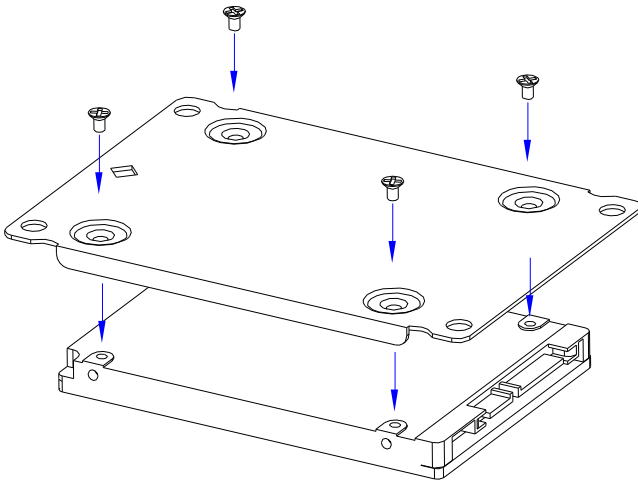

Step 2: Assemble the 2.5" HDD Driver kit with bottom case and connect the SATA signal cable and SATA power cable with the 2.5" SATA HDD Drive.

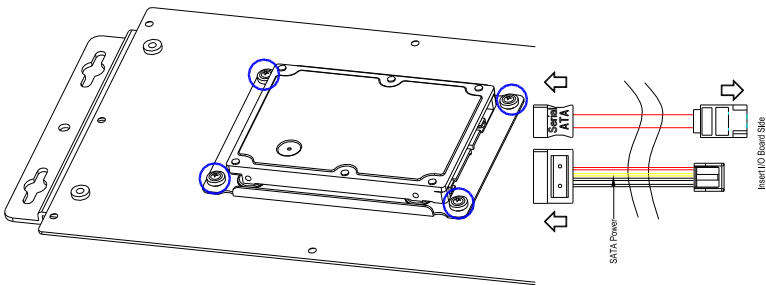

2.8 Power Connector Installation

Step 1: Take out 3-pin green phoenix power connector from the accessory kit



Step 2: Refer to below power pin out



Chapter 3

AMI BIOS Setup

3.1 System Test and Initialization

The system uses certain routines to perform testing and initialization. If an error, fatal or non-fatal, is encountered, a few short beeps or an error message will be outputted. The board can usually continue the boot up sequence with non-fatal errors.

The system configuration verification routines check the current system configuration against the values stored in the CMOS memory. If they do not match, an error message will be outputted, in which case you will need to run the BIOS setup program to set the configuration information in memory.

There are three situations in which you will need to change the CMOS settings:

- You are starting your system for the first time
- You have changed your system's hardware
- The CMOS memory has lost power and the configuration information is erased

The system's CMOS memory uses a backup battery for data retention, which is to be replaced once emptied.

3.2 AMI BIOS Setup

The AMI BIOS ROM has a pre-installed Setup program that allows users to modify basic system configurations, which is stored in the battery-backed CMOS RAM and BIOS NVRAM so that the information is retained when the power is turned off.

To enter BIOS Setup, press or <F2> immediately while your computer is powering up.

The function for each interface can be found below.

Main – Date and time can be set here. Press <Tab> to switch between date elements

Advanced – Enable/ Disable boot option for legacy network devices

Chipset – For hosting bridge parameters

Security – The setup administrator password can be set here

Boot – Enable/ Disable quiet Boot Option

Save & Exit – Save your changes and exit the program

3.3 Setup Submenu: Main

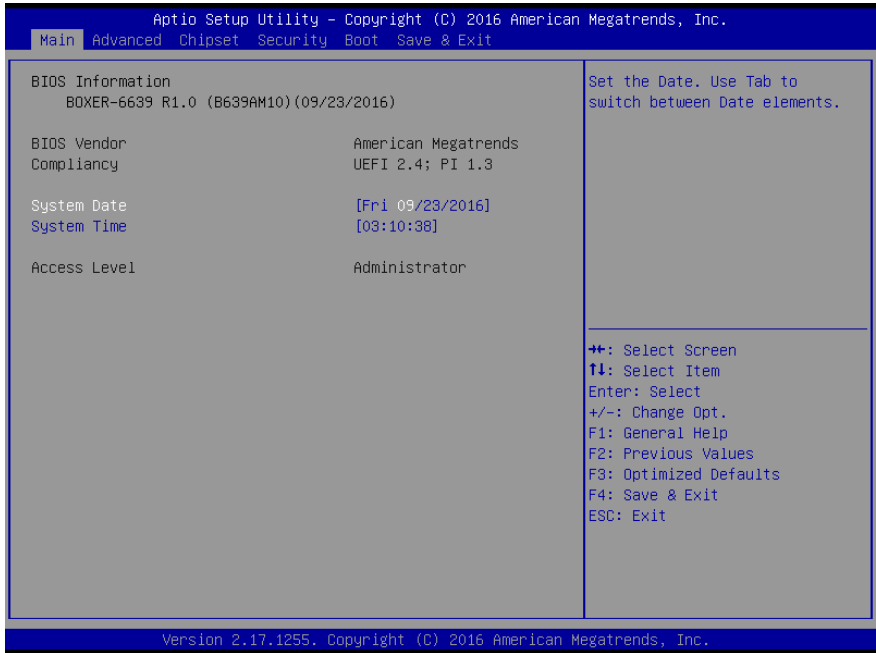

3.4 Setup Submenu: Advanced

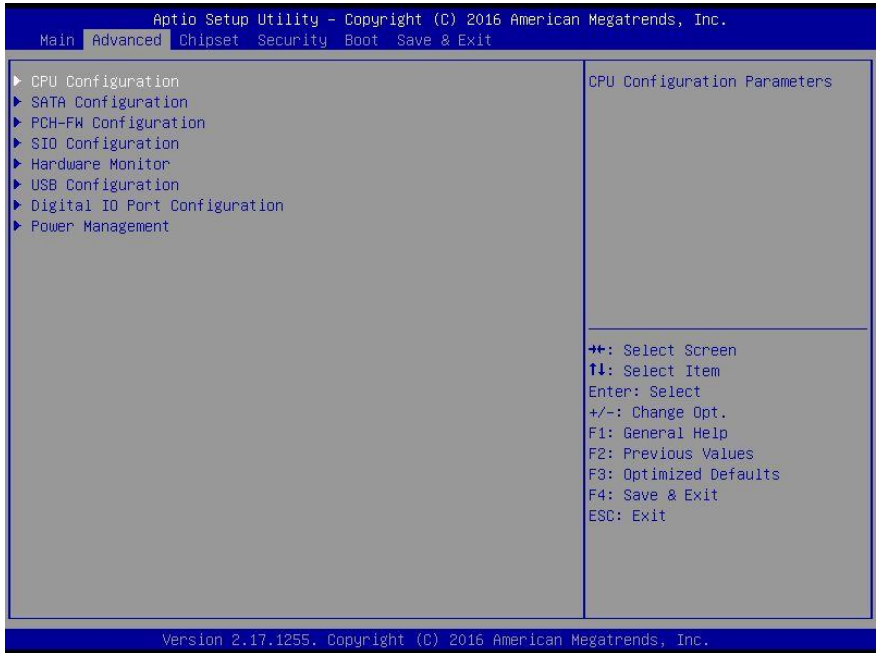

3.4.1 Advanced: CPU Configuration

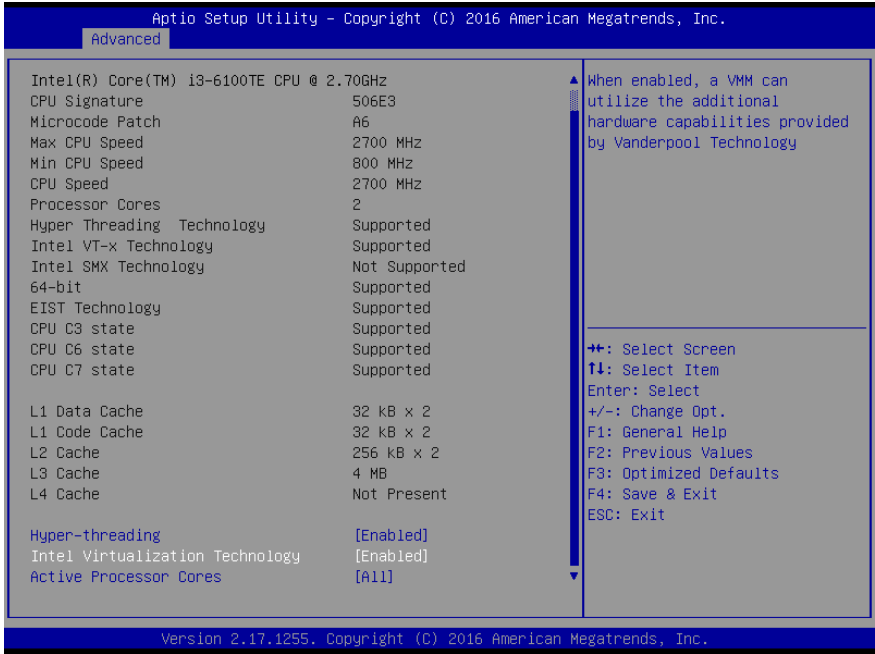

Options summary:

Hyper-threading	Disabled	
	Enabled	Optimal Default, Failsafe Default
Enabled for Windows XP and Linux (OS optimized for Hyper-Threading Technology) and Disabled for other OS (OS not optimized for Hyper-Threading Technology). When Disabled only one thread per enabled core is enabled.		
Intel Virtualization Technology	Disabled	
	Enabled	Optimal Default, Failsafe Default
When enabled, a VMM can utilize the additional hardware capabilities provided by Vanderpool Technology		
Active Processor Cores	1	
	All	Optimal Default, Failsafe Default
Number of cores to enable in each processor package.		

3.4.2 Advanced: SATA Configuration

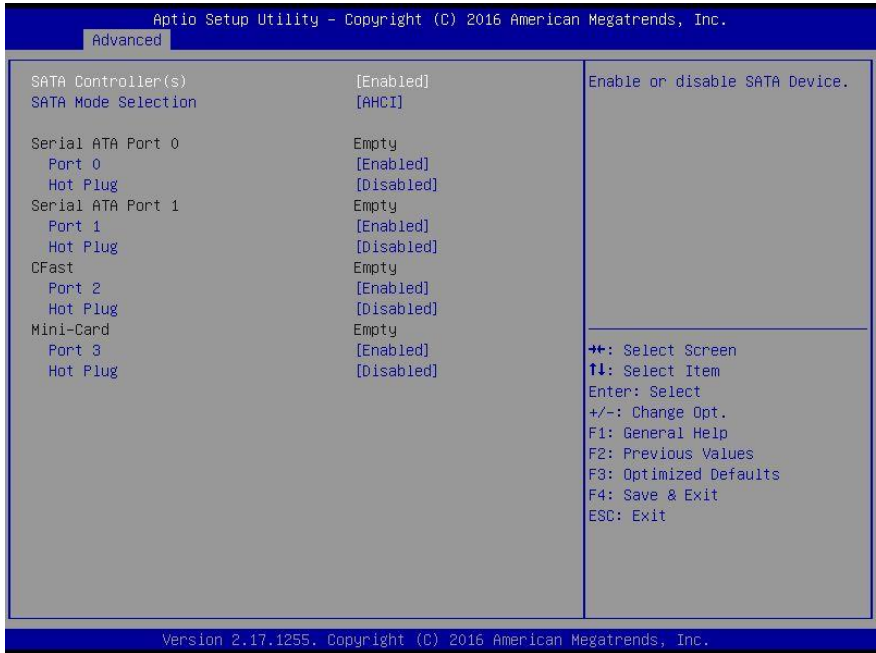

Options summary:

SATA Controller(s)	Enabled	Optimal Default, Failsafe Default
	Disabled	
Enable or Disable SATA Device.		
SATA Mode Selection	IDE Mode	
	AHCI Mode	Optimal Default, Failsafe Default
Determines how SATA controller(s) operate.		
Port 0/1/2/3	Enabled	Optimal Default, Failsafe Default
	Disabled	
Enable or Disable SATA Port.		
Hot Plug	Enabled	
	Disabled	Optimal Default, Failsafe Default
Designates this port as Hot Pluggable.		

3.4.3 Advanced: PCH-FW Configuration

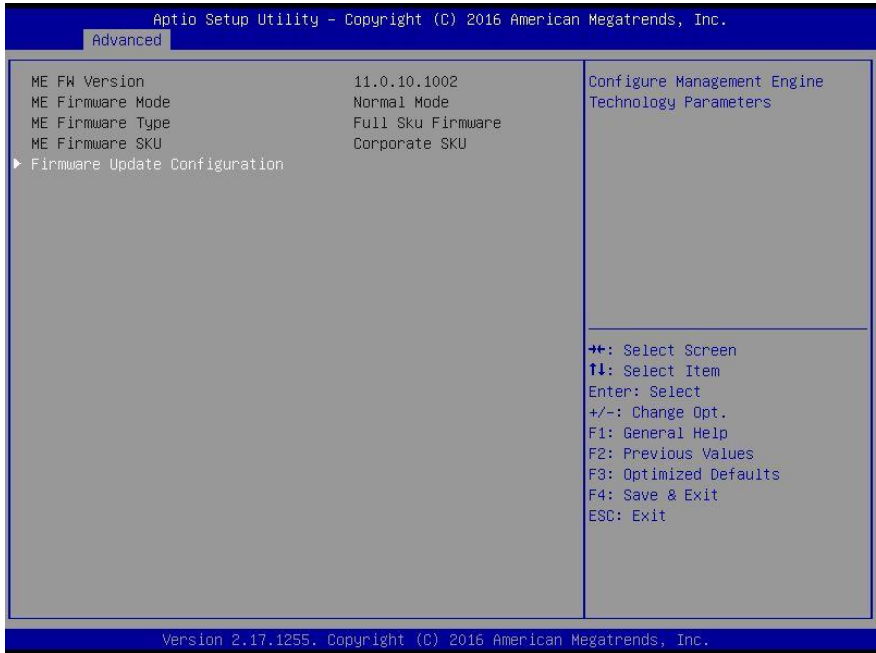

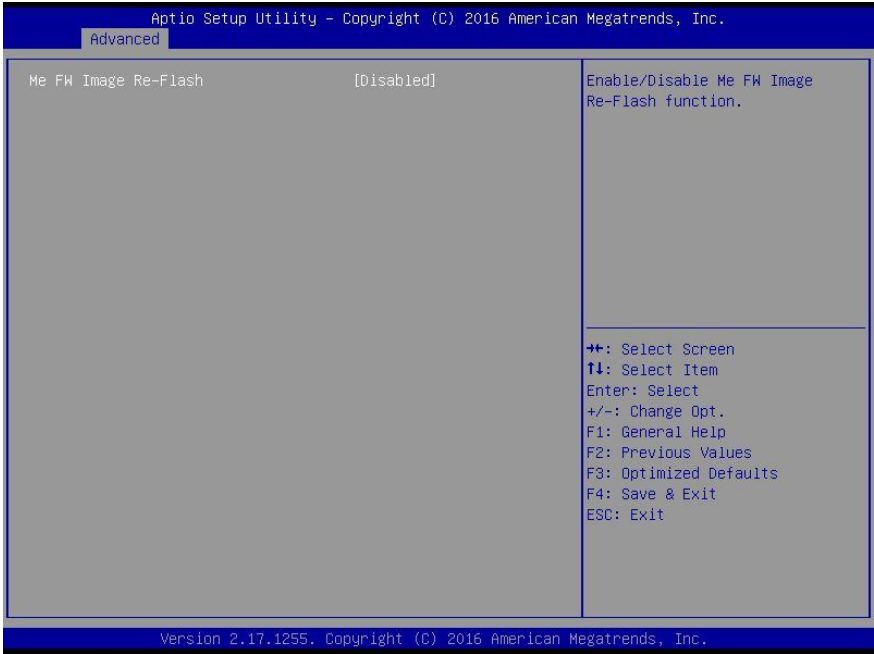

Options summary:

ME FW Image Re-Flash	Enabled	Optimal Default, Failsafe Default
	Disabled	
Enable or Disable ME FW Image Re-Flash function.		

3.4.4 Advanced: SIO Configuration

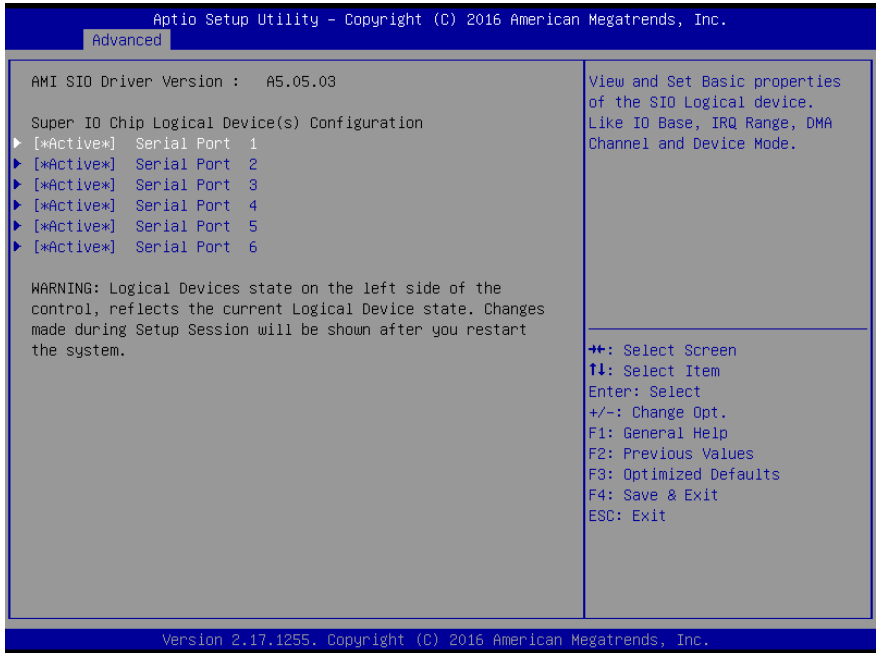

3.4.4.1 SIO Configuration: Serial Port 1 Configuration

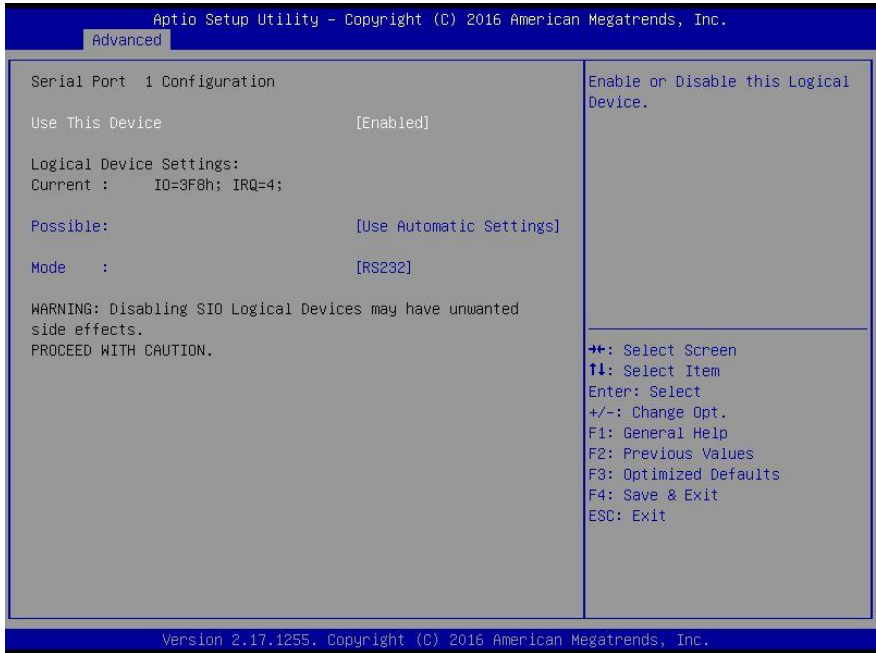

Options summary:

Use This Device	Disabled Enabled	Optimal Default, Failsafe Default
Enable or Disable this Logical Device.		
Possible:	Use Automatic Settings IO=2F8; IRQ=3; IO=3F8; IRQ=4;	Optimal Default, Failsafe Default
Allows user to change Device's Resource settings. New settings will be reflected on This Setup Page after System restarts.		
Mode:	RS232 RS422 RS485	Optimal Default, Failsafe Default
UART RS232, 422, 485 selection		

3.4.4.2 SIO Configuration: Serial Port 2 Configuration

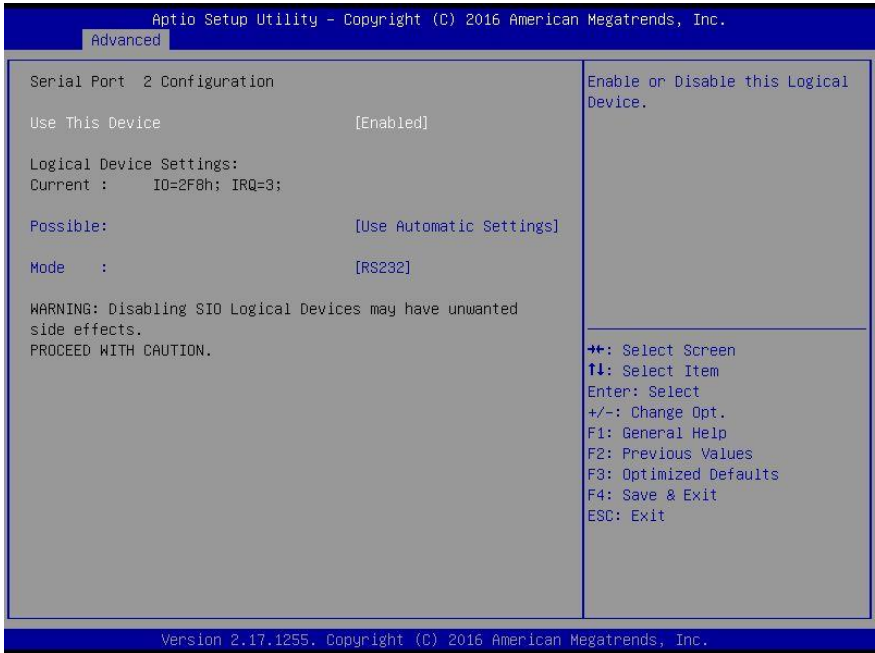

Options summary:

Use This Device	Disabled	Optimal Default, Failsafe Default
	Enabled	
Enable or Disable this Logical Device.		
Possible:	Use Automatic Settings	Optimal Default, Failsafe Default
	IO=2F8; IRQ=3;	
	IO=3F8; IRQ=4;	
Allows user to change Device's Resource settings. New settings will be reflected on This Setup Page after System restarts.		
Mode:	RS232	Optimal Default, Failsafe Default
	RS422	
	RS485	
UART RS232, 422, 485 selection		

3.4.4.3 SIO Configuration: Serial Port 3 Configuration

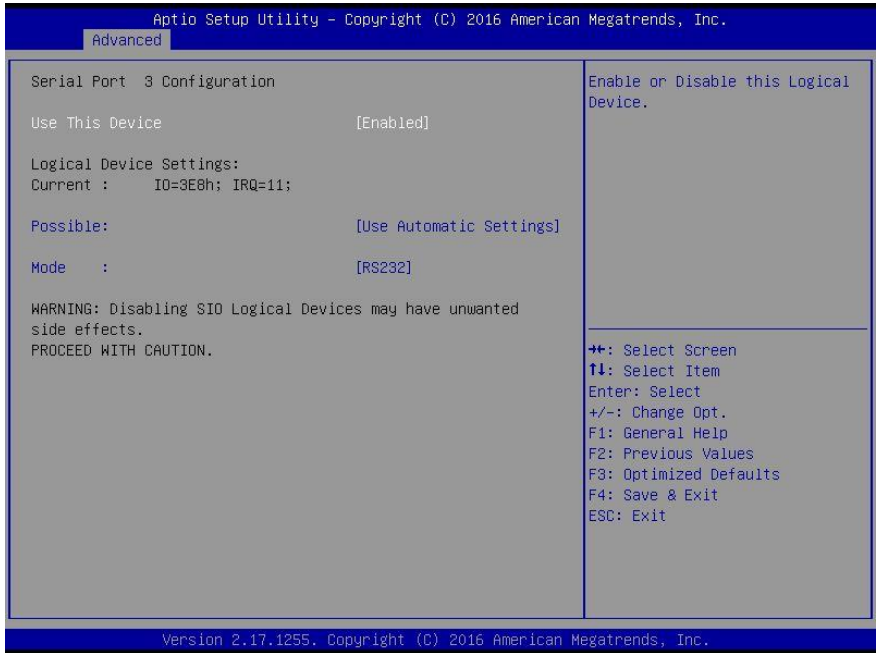

Options summary:

Use This Device	Disabled	Optimal Default, Failsafe Default
	Enabled	
Enable or Disable this Logical Device.		
Possible:	Use Automatic Settings	Optimal Default, Failsafe Default
	IO=2F8; IRQ=11;	
	IO=3F8; IRQ=11;	
Allows user to change Device's Resource settings. New settings will be reflected on This Setup Page after System restarts.		
Mode:	RS232	Optimal Default, Failsafe Default
	RS422	
	RS485	
UART RS232, 422, 485 selection		

3.4.4.4 SIO Configuration: Serial Port 4 Configuration

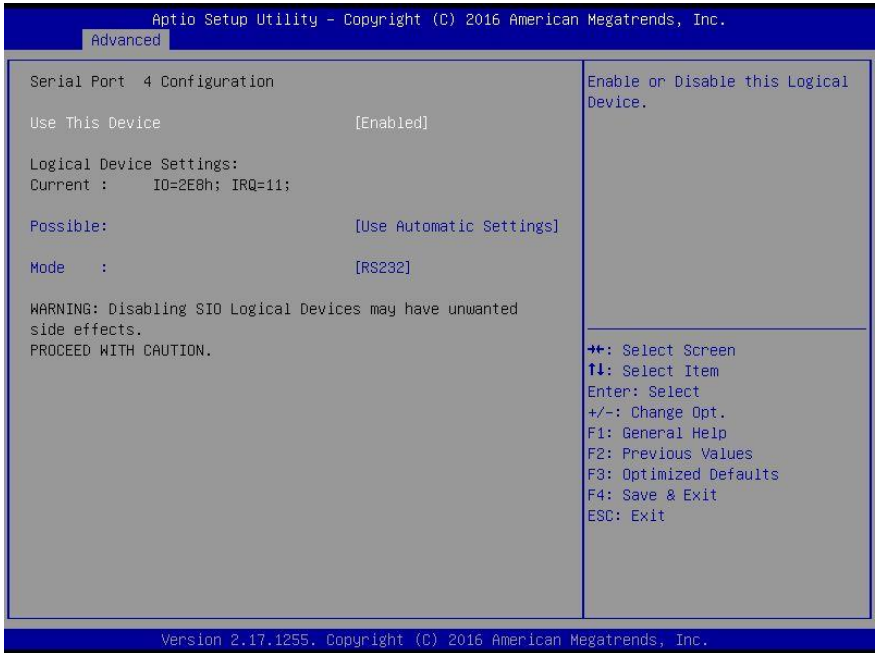

Options summary:

Use This Device	Disabled	Optimal Default, Failsafe Default
	Enabled	
Enable or Disable this Logical Device.		
Possible:	Use Automatic Settings	Optimal Default, Failsafe Default
	IO=2F8; IRQ=11;	
	IO=3F8; IRQ=11;	
Allows user to change Device's Resource settings. New settings will be reflected on This Setup Page after System restarts.		
Mode:	RS232	Optimal Default, Failsafe Default
	RS422	
	RS485	
UART RS232, 422, 485 selection		

3.4.4.5 SIO Configuration: Serial Port 5 Configuration

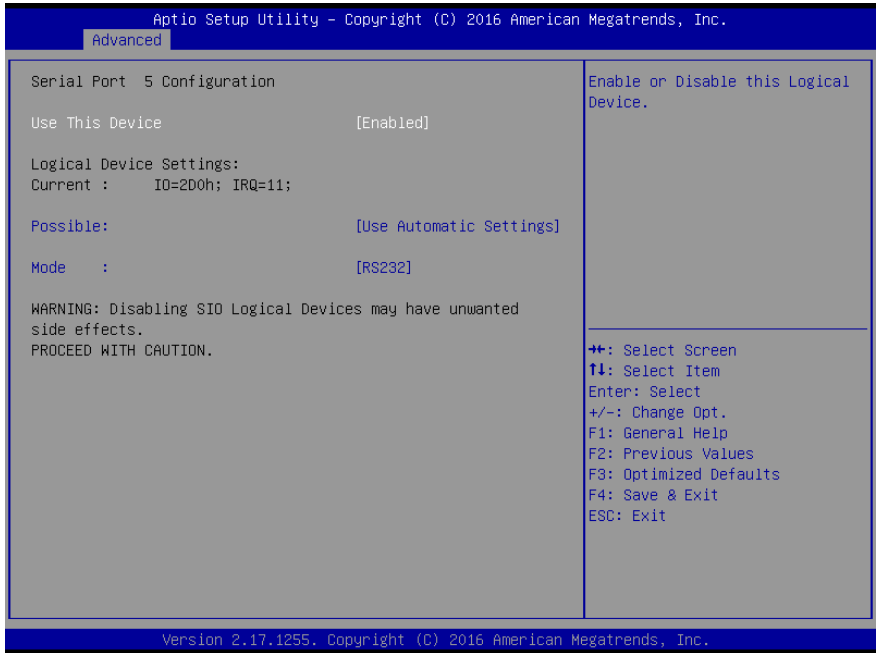

Options summary:

Use This Device	Disabled	Optimal Default, Failsafe Default
	Enabled	
Enable or Disable this Logical Device.		
Possible:	Use Automatic Settings	Optimal Default, Failsafe Default
	IO=2D0; IRQ=11;	
	IO=2C0; IRQ=11;	
Allows user to change Device's Resource settings. New settings will be reflected on This Setup Page after System restarts.		
Mode:	RS232	Optimal Default, Failsafe Default
	RS422	
	RS485	
UART RS232, 422, 485 selection		

3.4.4.6 SIO Configuration: Serial Port 6 Configuration

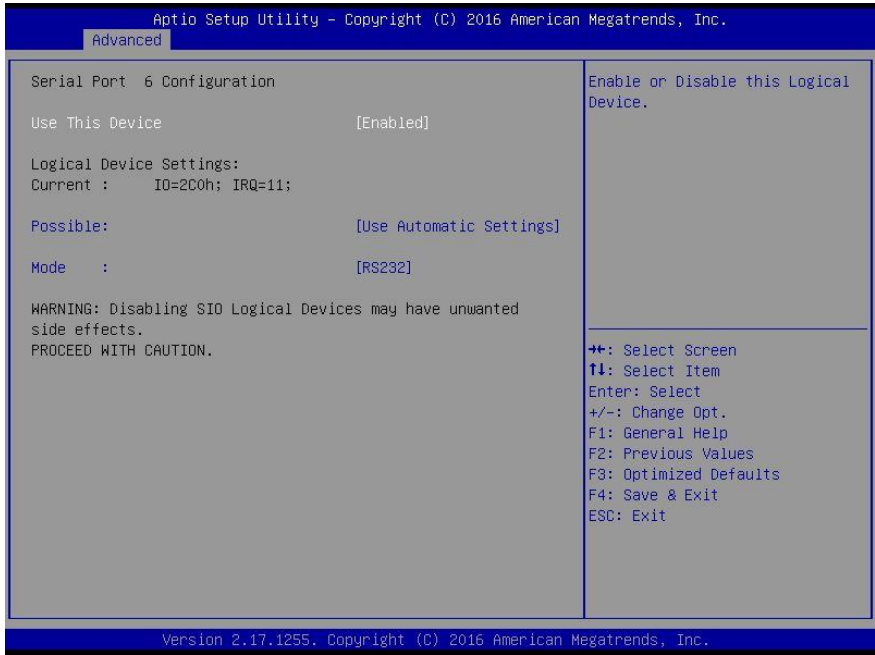

Options summary:

Use This Device	Disabled	Optimal Default, Failsafe Default
	Enabled	
Enable or Disable this Logical Device.		
Possible:	Use Automatic Settings	Optimal Default, Failsafe Default
	IO=2D0; IRQ=11;	
	IO=2C0; IRQ=11;	
Allows user to change Device's Resource settings. New settings will be reflected on This Setup Page after System restarts.		
Mode:	RS232	Optimal Default, Failsafe Default
	RS422	
	RS485	
UART RS232, 422, 485 selection		

3.4.5 Advanced: Hardware Monitor

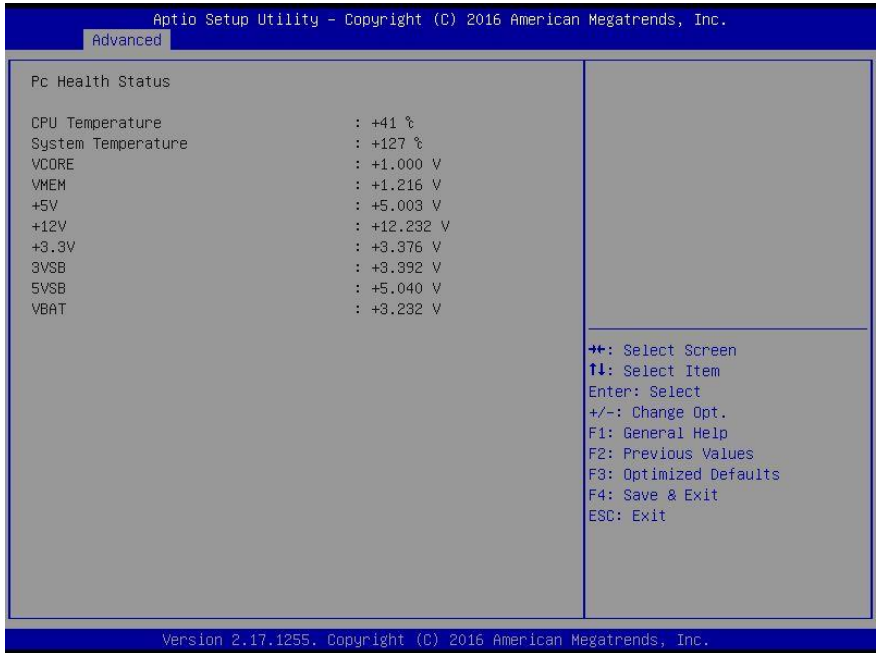

3.4.6 Advanced: USB Configuration

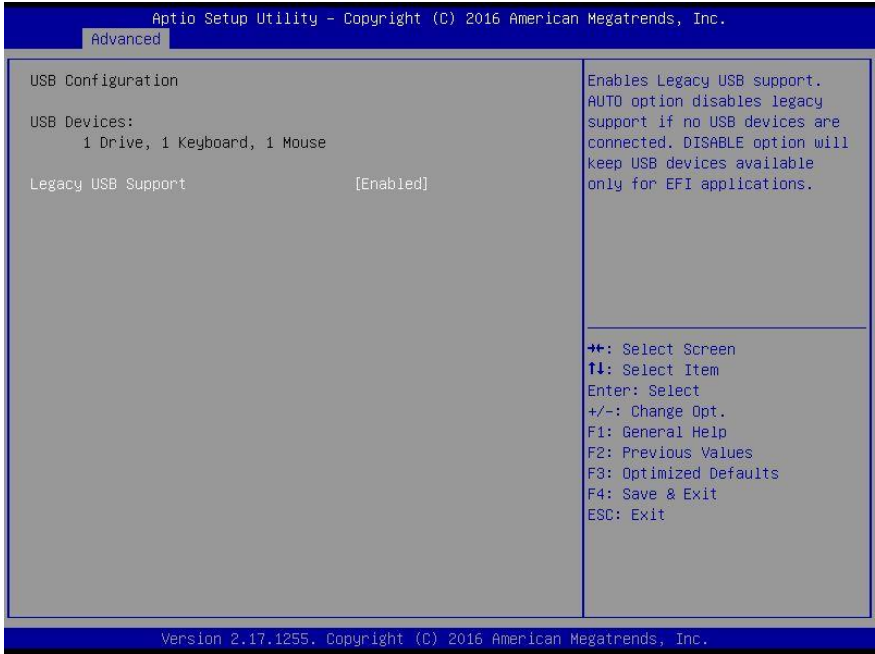

Options summary:

Legacy USB Support	Enabled	Optimal Default, Failsafe Default
	Disabled	
	Auto	
Enables Legacy USB support. AUTO option disables legacy support if no USB devices are connected. DISABLE option will keep USB devices available only for EFI applications.		

3.4.7 Advanced: Digital IO Port Configuration

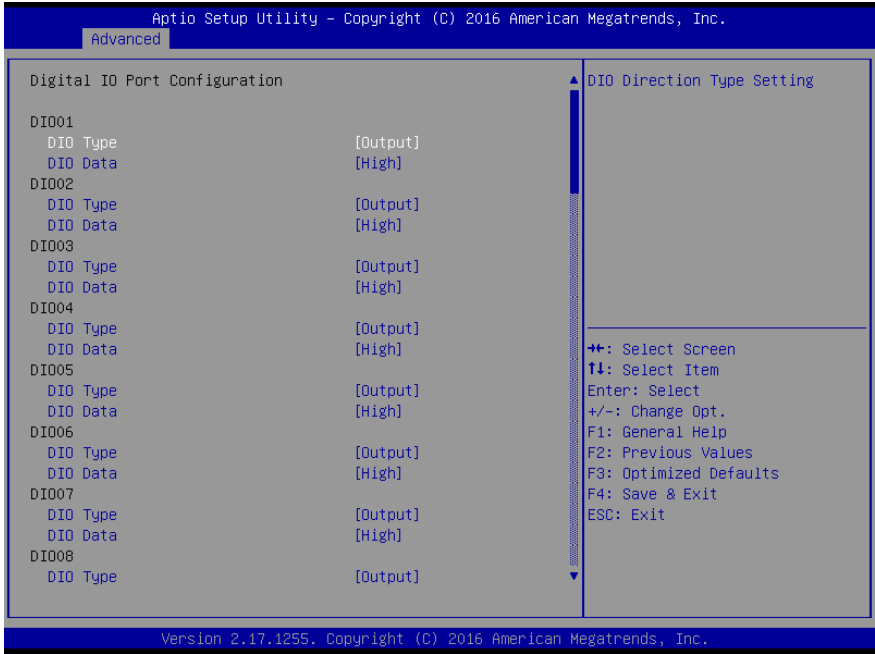

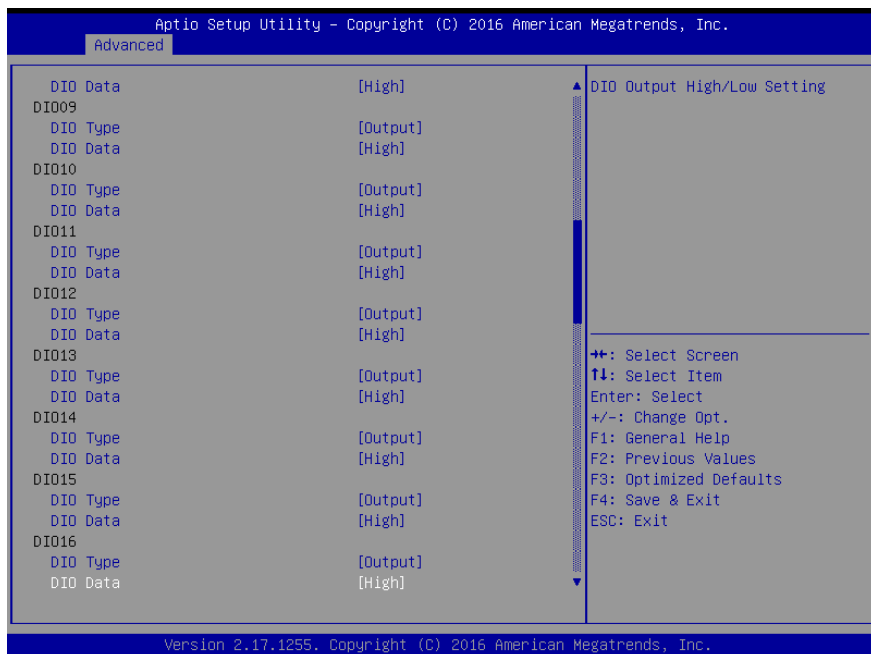

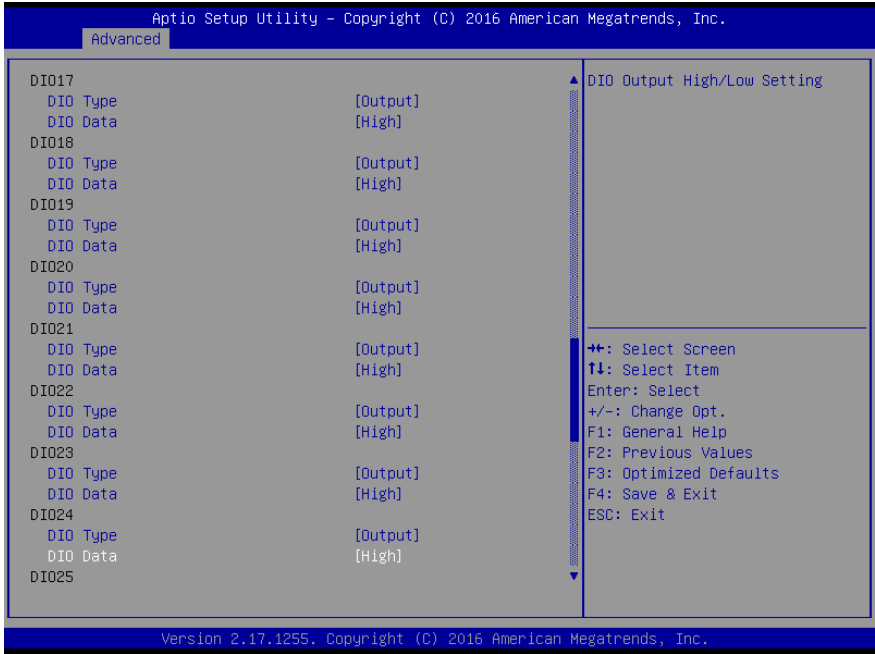



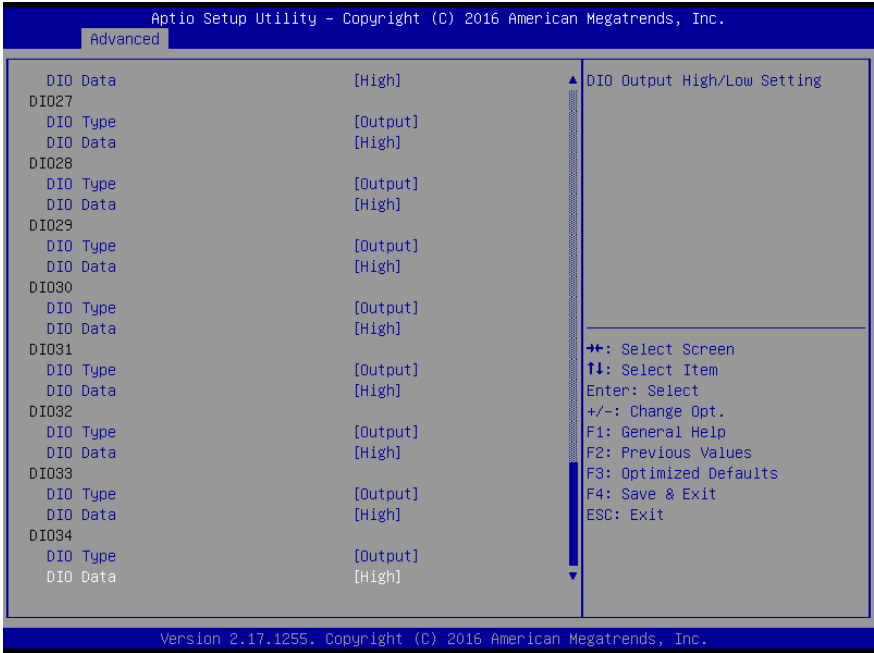

Options summary:

DIO Type	Output	Optimal Default, Failsafe Default
	Input	
DIO Direction Type Setting		
DIO Data	Low	Optimal Default, Failsafe Default
	High	
DIO Output High/Low Setting		

3.4.8 Advanced: Power Management

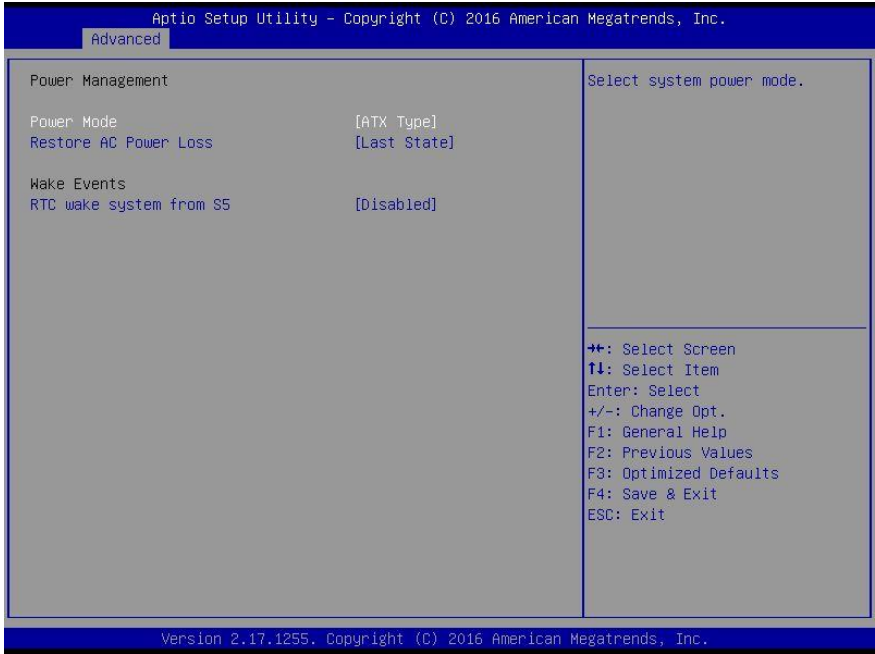

Options summary:

Power Mode	ATX Type	Optimal Default, Failsafe Default
	AT Type	
Select power supply mode.		
AC Power Loss	Last State	Optimal Default, Failsafe Default
	Power On	
	Power Off	
Select power state when power is re-applied after a power failure.		
RTC wake system from S5	Disabled	Optimal Default, Failsafe Default
	Fixed Time	
	Dynamic Time	
Fixed Time: System will wake on the hr::min::sec specified./n Dynamic Time: System will wake on the current time + Increase minute(s)		

3.5 Setup submenu: Chipset

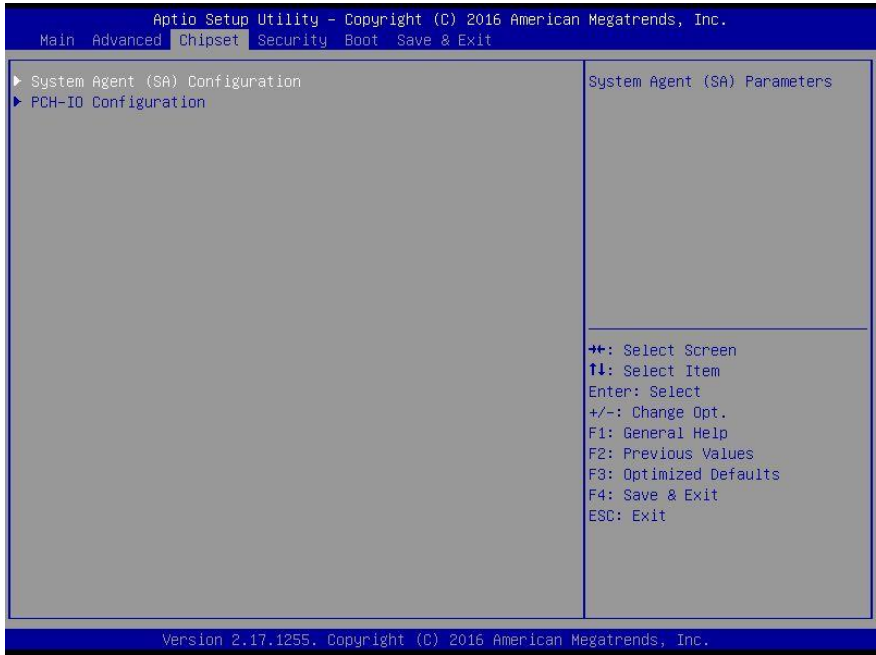

3.5.1 Chipset: System Agent (SA) Configuration

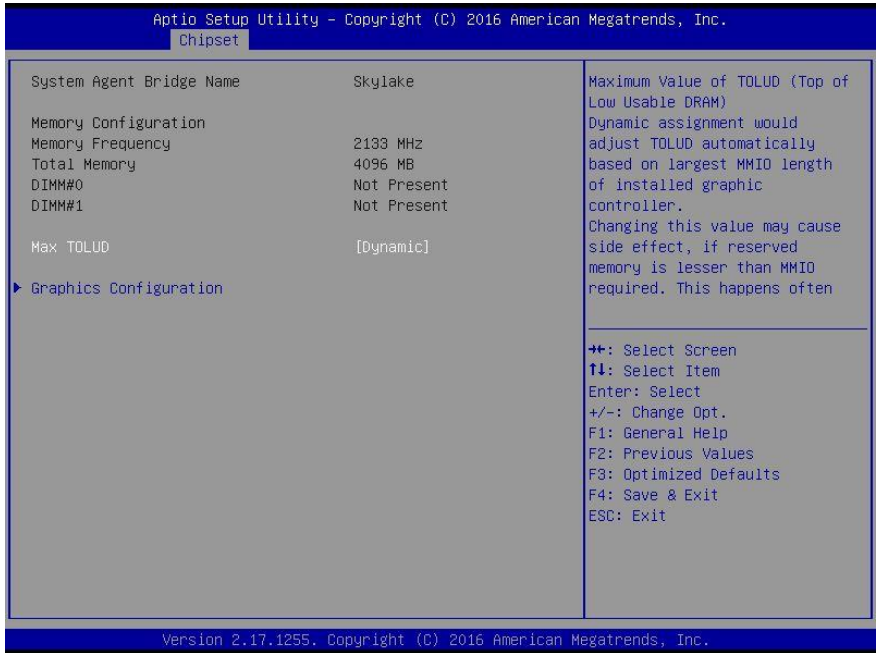

Options summary:

Max TOLUD	Dynamic	Optimal Default, Failsafe Default
	1 GB	
	1.25 GB	
	1.5 GB	
	1.75 GB	
	2 GB	
	2.25 GB	
	2.5 GB	
	2.75 GB	
	3 GB	
3.25 GB		
<p>Maximum Value of TOLUD (Top of Low Usable DRAM)\nDynamic assignment would adjust TOLUD automatically based on largest MMIO length of installed graphic controller.\nChanging this value may cause side effect, if reserved memory is lesser than MMIO required. This happens often when GFX device with large MMIO requirement.</p>		

3.5.1.1 System Agent (SA) Configuration: Graphics Configuration

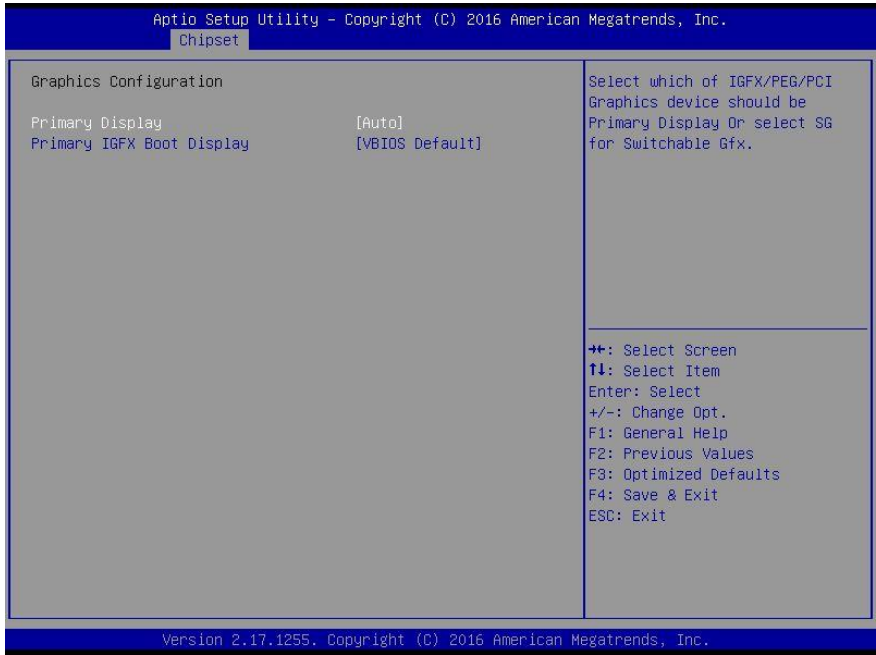

Options summary:

Primary Display	Auto	Optimal Default, Failsafe Default
	IGFX	
	PCI-E	
Primary IGFX Boot Display	VBIOS default	Optimal Default, Failsafe Default
	HDMI 1	
	CRT	
Secondary IGFX Boot Display	Disable	Optimal Default, Failsafe Default
	HDMI 1	
	CRT	
	HDMI 2	

3.5.2 Chipset: PCH-IO Configuration

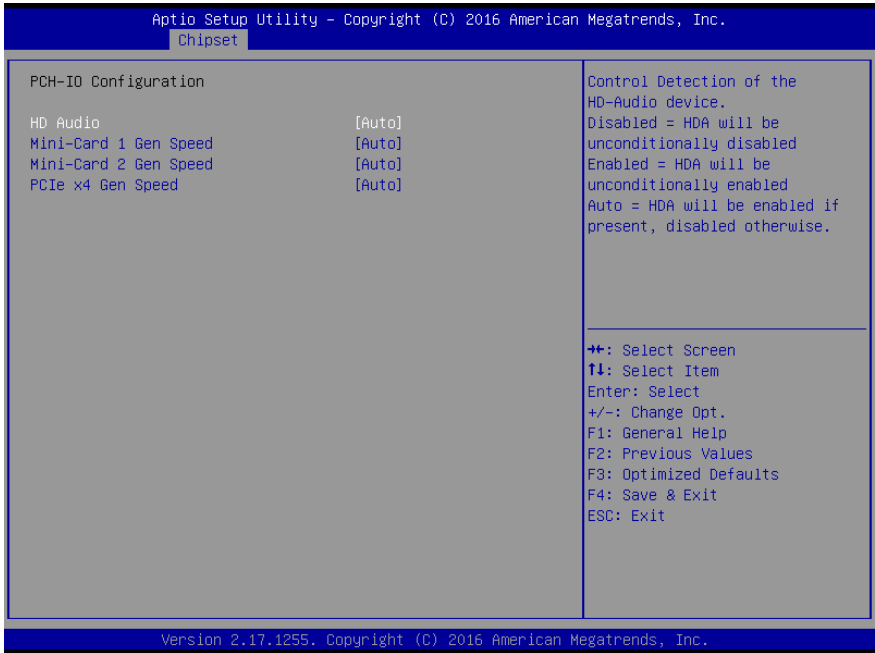

Options summary:

HD Audio	<table border="1" style="width: 100%; border-collapse: collapse;"> <tr><td style="padding: 2px;">Disabled</td></tr> <tr><td style="padding: 2px;">Enabled</td></tr> <tr><td style="padding: 2px;">Auto</td></tr> </table>	Disabled	Enabled	Auto	Optimal Default, Failsafe Default	
Disabled						
Enabled						
Auto						
Control Detection of the HD-Audio device.\n\nDisabled = HDA will be unconditionally disabled\n\nEnabled = HDA will be unconditionally enabled\n\nAuto = HDA will be enabled if present, disabled otherwise.						
Mini-Card 1 Gen Speed	<table border="1" style="width: 100%; border-collapse: collapse;"> <tr><td style="padding: 2px;">Auto</td></tr> <tr><td style="padding: 2px;">Gen1</td></tr> <tr><td style="padding: 2px;">Gen2</td></tr> <tr><td style="padding: 2px;">Gen3</td></tr> </table>	Auto	Gen1	Gen2	Gen3	Optimal Default, Failsafe Default
Auto						
Gen1						
Gen2						
Gen3						
Select PCI Express port speed						
Mini-Card 2 Gen Speed	<table border="1" style="width: 100%; border-collapse: collapse;"> <tr><td style="padding: 2px;">Auto</td></tr> <tr><td style="padding: 2px;">Gen1</td></tr> <tr><td style="padding: 2px;">Gen2</td></tr> <tr><td style="padding: 2px;">Gen3</td></tr> </table>	Auto	Gen1	Gen2	Gen3	Optimal Default, Failsafe Default
Auto						
Gen1						
Gen2						
Gen3						

Select PCI Express port speed		
PCIe x4 Gen Speed	Auto	Optimal Default, Failsafe Default
	Gen1	
	Gen2	
	Gen3	
Select PCI Express port speed		

3.6 Setup submenu: Security

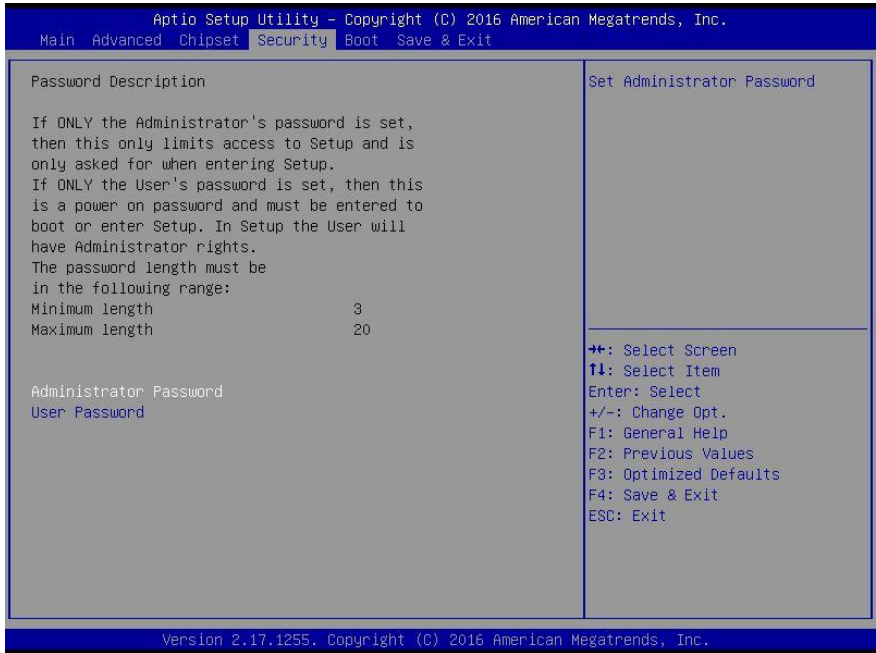

Change User/Administrator Password

You can set a User Password once an Administrator Password is set. The password will be required during boot up, or when the user enters the Setup utility. Please Note that a User Password does not provide access to many of the features in the Setup utility. Select the password you wish to set, press Enter to open a dialog box to enter your password (you can enter no more than six letters or numbers). Press Enter to confirm your entry, after which you will be prompted to retype your password for a final confirmation. Press Enter again after you have retyped it correctly.

Removing the Password

Highlight this item and type in the current password. At the next dialog box press Enter to disable password protection.

3.7 Setup submenu: Boot

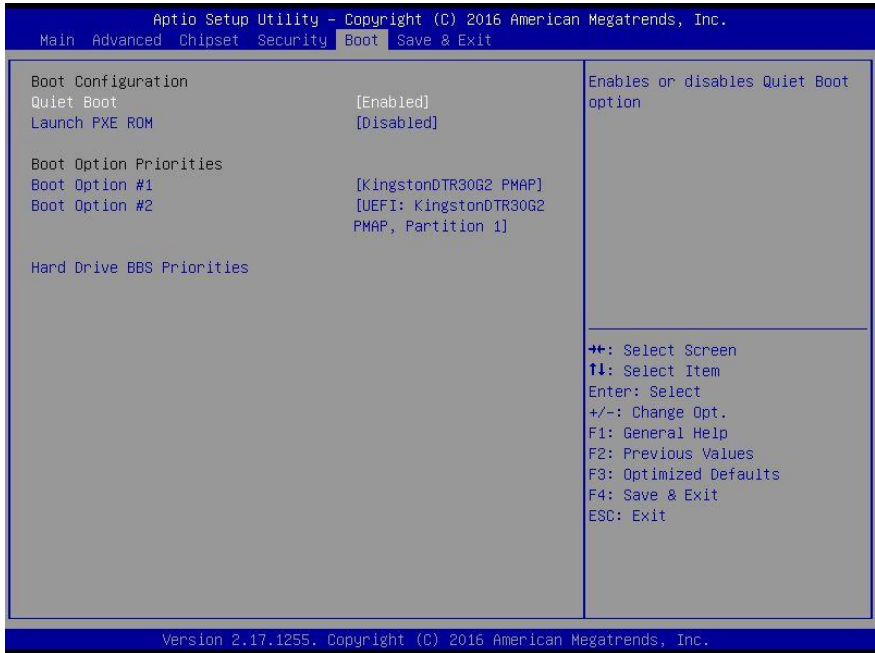

Options summary:

Quiet Boot	Disabled	Optimal Default, Failsafe Default
	Enabled	
Enables or disables Quiet Boot option.		
Launch PXE OpROM	Disabled	Optimal Default, Failsafe Default
	Enabled	
Controls the execution of UEFI and Legacy PXE OpROM.		

3.7.1 Boot: BBS Priorities

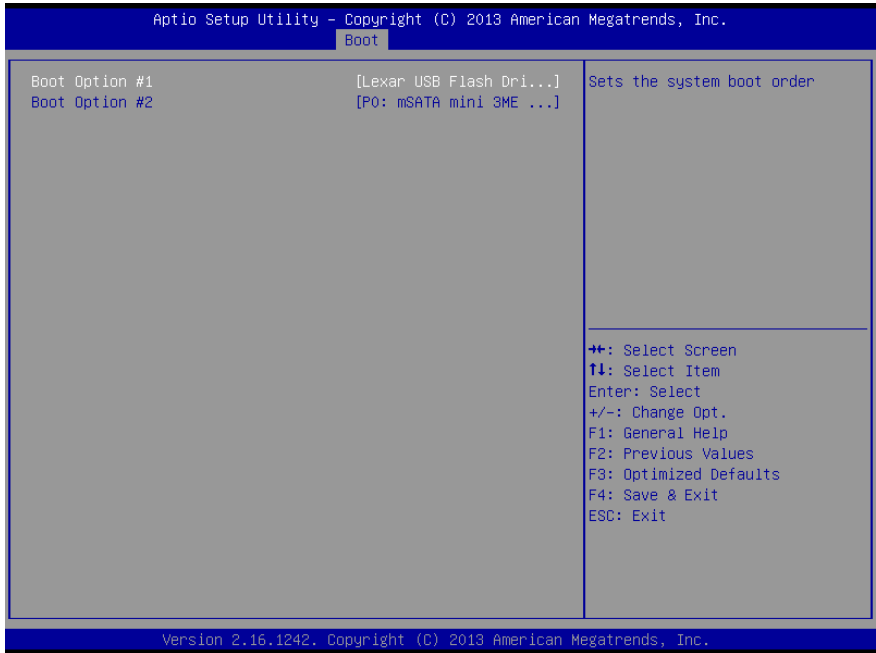

3.8 Setup submenu: Save & Exit

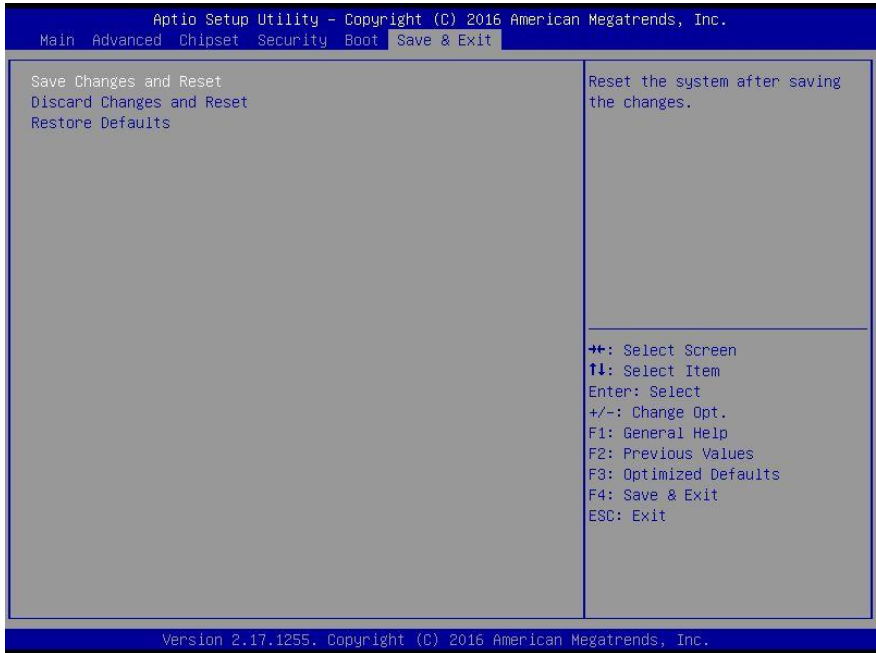

Chapter 4

Drivers Installation

4.1 Product CD/DVD

The BOXER-6639 comes with a product DVD that contains all the drivers and utilities you need to setup your product. Insert the DVD and follow the steps in the autorun program to install the drivers.

In case the program does not start, follow the sequence below to install the drivers.

Step 1 – Install Chipset Driver

1. Open the **Step1 - Chipset** folder and select your OS
2. Open the **SetupChipset.exe** file in the folder
3. Follow the instructions
4. Drivers will be installed automatically

Step 2 – Install Graphics Driver

1. Open the **Step2 - Graphic** folder and select your OS
2. Open the **Setup.exe** file in the folder
3. Follow the instructions
4. Drivers will be installed automatically

Step 3 – Install LAN Driver

1. Open the **Step3 - LAN** folder and select your OS
2. Open the **.exe** file in the folder
3. Follow the instructions
4. Drivers will be installed automatically

Step 4 – Install Audio Driver

1. Open the **Step4 - Audio** folder and select your OS
2. followed by the **.exe** file in the folder
3. Follow the instructions
4. Drivers will be installed automatically

Step 5 – Install USB3.0 Driver

1. Open the **Step5 – USB3.0** folder and select your OS
2. Open the **.exe** file in the folder
3. Follow the instructions
4. Drivers will be installed automatically

Step 6 – Install ME Driver

1. Open the **Step6 - ME** folder and select your OS
2. Open the **SetupME.exe** file in the folder
3. Follow the instructions
4. Drivers will be installed automatically

Step 7 – Install Serial Port Driver (Optional)

For Windows 7:

1. Change User Account Control settings to **Never notify**

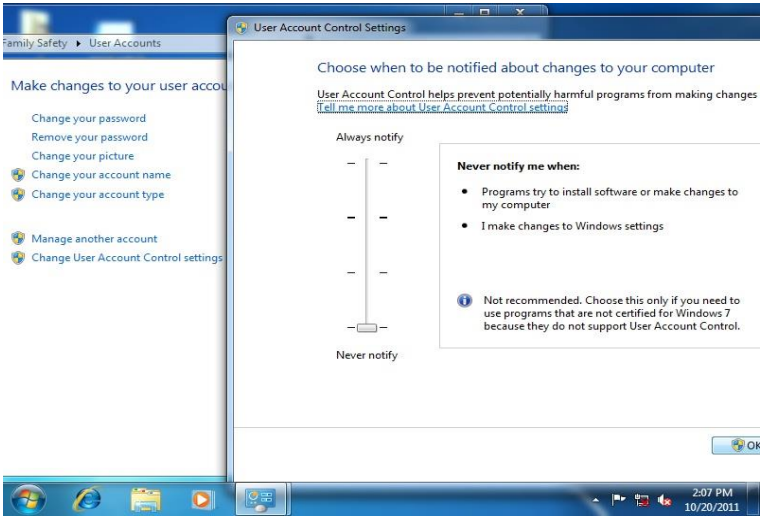

2. Reboot and log in as administrator

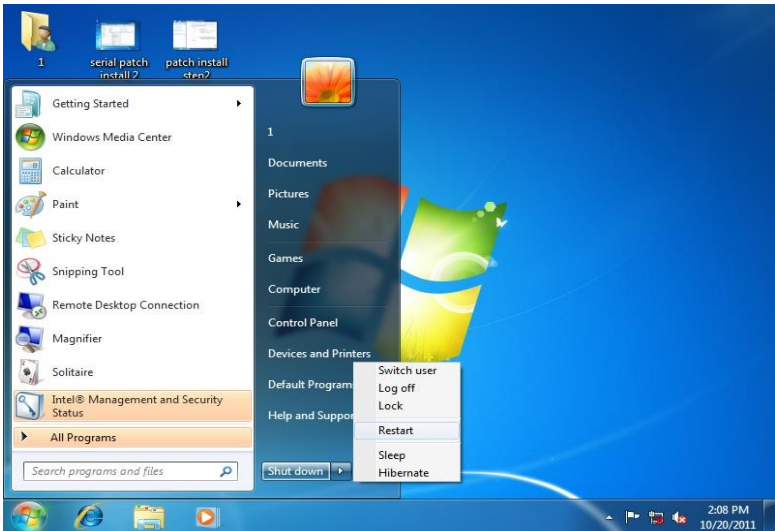

3. Run `patch.bat` as administrator

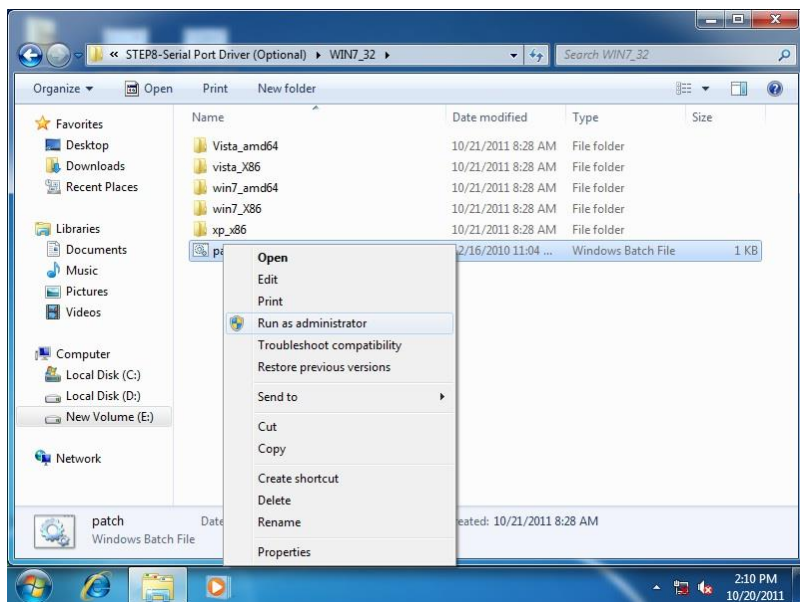

For Windows 8 and Windows 10:

1. Open the **Step 7 - Serial Port Driver (Optional)** folder and select your OS
2. Open the **Setup.exe** file in the folder
3. Follow the instructions
4. Drivers will be installed automatically

Appendix A

Watchdog Timer Programming

A.1 Watchdog Timer Initial Program

Table 1 : SuperIO relative register table		
	Default Value	Note
Index	0x2E(Note1)	SIO MB PnP Mode Index Register 0x2E or 0x4E
Data	0x2F(Note2)	SIO MB PnP Mode Data Register 0x2F or 0x4F

Table 2 : Watchdog relative register table					
	LDN	Register	BitNum	Value	Note
Timer Counter	0x07(Note3)	0xF6(Note4)		(Note24)	Time of watchdog timer (0~255) This register is byte access
Counting Unit	0x07(Note5)	0xF5(Note6)	3(Note7)	0(Note8)	Select time unit. 0: second 1: minute
Watchdog Enable	0x07(Note9)	0xF5(Note10)	5(Note11)	1(Note12)	0: Disable 1: Enable
Timeout Status	0x07(Note13)	0xF5(Note14)	6(Note15)	1	1: Clear timeout status
Output Mode	0x07(Note16)	0xF5(Note17)	4(Note18)	1(Note19)	Select WDTRST# output mode 0: level 1: pulse
WDTRST output	0x07(Note20)	0xFA(Note21)	0(Note22)	1(Note23)	Enable/Disable time out output via WDTRST# 0: Disable 1: Enable

```

















































*****
// SuperIO relative definition (Please reference to Table 1)
#define byte SIOIndex //This parameter is represented from Note1
#define byte SIOData //This parameter is represented from Note2
#define void IOWriteByte(byte IOPort, byte Value);
#define byte IOReadByte(byte IOPort);
// Watch Dog relative definition (Please reference to Table 2)
#define byte TimerLDN //This parameter is represented from Note3
#define byte TimerReg //This parameter is represented from Note4
#define byte TimerVal // This parameter is represented from Note24
#define byte UnitLDN //This parameter is represented from Note5
#define byte UnitReg //This parameter is represented from Note6
#define byte UnitBit //This parameter is represented from Note7
#define byte UnitVal //This parameter is represented from Note8
#define byte EnableLDN //This parameter is represented from Note9
#define byte EnableReg //This parameter is represented from Note10
#define byte EnableBit //This parameter is represented from Note11
#define byte EnableVal //This parameter is represented from Note12
#define byte StatusLDN // This parameter is represented from Note13
#define byte StatusReg // This parameter is represented from Note14
#define byte StatusBit // This parameter is represented from Note15
#define byte ModeLDN // This parameter is represented from Note16
#define byte ModeReg // This parameter is represented from Note17
#define byte ModeBit // This parameter is represented from Note18
#define byte ModeVal // This parameter is represented from Note19
#define byte WDRstLDN // This parameter is represented from Note20
#define byte WDRstReg // This parameter is represented from Note21
#define byte WDRstBit // This parameter is represented from Note22
#define byte WDRstVal // This parameter is represented from Note23
*****

```

Appendix B

I/O Information

















B.1 I/O Address Map

▼		Input/output (IO)
	[0000000000000000 - 000000000000CF7]	PCI Express Root Complex
	[0000000000000020 - 0000000000000021]	Programmable interrupt controller
	[0000000000000020 - 0000000000000021]	Programmable interrupt controller
	[0000000000000024 - 0000000000000025]	Programmable interrupt controller
	[0000000000000024 - 0000000000000025]	Programmable interrupt controller
	[0000000000000028 - 0000000000000029]	Programmable interrupt controller
	[0000000000000028 - 0000000000000029]	Programmable interrupt controller
	[000000000000002C - 000000000000002D]	Programmable interrupt controller
	[000000000000002C - 000000000000002D]	Programmable interrupt controller
	[000000000000002E - 000000000000002F]	Motherboard resources
	[0000000000000030 - 0000000000000031]	Programmable interrupt controller
	[0000000000000030 - 0000000000000031]	Programmable interrupt controller
	[0000000000000034 - 0000000000000035]	Programmable interrupt controller
	[0000000000000034 - 0000000000000035]	Programmable interrupt controller
	[0000000000000038 - 0000000000000039]	Programmable interrupt controller
	[0000000000000038 - 0000000000000039]	Programmable interrupt controller
	[000000000000003C - 000000000000003D]	Programmable interrupt controller
	[000000000000003C - 000000000000003D]	Programmable interrupt controller
	[0000000000000040 - 0000000000000043]	System timer
	[0000000000000040 - 0000000000000043]	System timer
	[000000000000004E - 000000000000004F]	Motherboard resources
	[0000000000000050 - 0000000000000053]	System timer
	[0000000000000050 - 0000000000000053]	System timer
	[0000000000000060 - 0000000000000060]	Standard PS/2 Keyboard
	[0000000000000061 - 0000000000000061]	Motherboard resources
	[0000000000000063 - 0000000000000063]	Motherboard resources
	[0000000000000064 - 0000000000000064]	Standard PS/2 Keyboard
	[0000000000000065 - 0000000000000065]	Motherboard resources
	[0000000000000067 - 0000000000000067]	Motherboard resources
	[0000000000000070 - 0000000000000070]	Motherboard resources
	[0000000000000070 - 0000000000000077]	System CMOS/real time clock
	[0000000000000070 - 0000000000000077]	System CMOS/real time clock
	[0000000000000080 - 0000000000000080]	Motherboard resources
	[0000000000000092 - 0000000000000092]	Motherboard resources
	[00000000000000A0 - 00000000000000A1]	Programmable interrupt controller
	[00000000000000A0 - 00000000000000A1]	Programmable interrupt controller
	[00000000000000A4 - 00000000000000A5]	Programmable interrupt controller
	[00000000000000A4 - 00000000000000A5]	Programmable interrupt controller
	[00000000000000A8 - 00000000000000A9]	Programmable interrupt controller
	[00000000000000A8 - 00000000000000A9]	Programmable interrupt controller
	[00000000000000AC - 00000000000000AD]	Programmable interrupt controller
	[00000000000000AC - 00000000000000AD]	Programmable interrupt controller
	[00000000000000B0 - 00000000000000B1]	Programmable interrupt controller
	[00000000000000B0 - 00000000000000B1]	Programmable interrupt controller
	[00000000000000B2 - 00000000000000B3]	Motherboard resources
	[00000000000000B4 - 00000000000000B5]	Programmable interrupt controller
	[00000000000000B4 - 00000000000000B5]	Programmable interrupt controller
	[00000000000000B8 - 00000000000000B9]	Programmable interrupt controller

	[00000000000000B8 - 00000000000000B9]	Programmable interrupt controller
	[00000000000000BC - 00000000000000BD]	Programmable interrupt controller
	[00000000000000BC - 00000000000000BD]	Programmable interrupt controller
	[00000000000000F0 - 00000000000000F0]	Numeric data processor
	[00000000000002C0 - 00000000000002C7]	Communications Port (COM6)
	[00000000000002D0 - 00000000000002D7]	Communications Port (COM5)
	[00000000000002E8 - 00000000000002EF]	Communications Port (COM4)
	[00000000000002F8 - 00000000000002FF]	Communications Port (COM2)
	[00000000000003B0 - 00000000000003BB]	Intel(R) HD Graphics 530
	[00000000000003C0 - 00000000000003DF]	Intel(R) HD Graphics 530
	[00000000000003E8 - 00000000000003EF]	Communications Port (COM3)
	[00000000000003F8 - 00000000000003FF]	Communications Port (COM1)
	[00000000000004D0 - 00000000000004D1]	Programmable interrupt controller
	[00000000000004D0 - 00000000000004D1]	Programmable interrupt controller
	[0000000000000680 - 000000000000069F]	Motherboard resources
	[0000000000000800 - 000000000000087F]	Motherboard resources
	[0000000000000A00 - 0000000000000A0F]	Motherboard resources
	[0000000000000A10 - 0000000000000A1F]	Motherboard resources
	[0000000000000A20 - 0000000000000A2F]	Motherboard resources
	[0000000000000D00 - 0000000000000FFF]	PCI Express Root Complex
	[000000000000164E - 000000000000164F]	Motherboard resources
	[0000000000001800 - 00000000000018FE]	Motherboard resources
	[0000000000001854 - 0000000000001857]	Motherboard resources
	[0000000000001854 - 0000000000001857]	Motherboard resources
	[000000000000C000 - 000000000000CFFF]	Intel(R) 100 Series/C230 Series Chipset Family PCI Express Root Port #13 - A11C
	[000000000000D000 - 000000000000DFFF]	Intel(R) 100 Series/C230 Series Chipset Family PCI Express Root Port #12 - A11B
	[000000000000E000 - 000000000000E07F]	RAID Controller
	[000000000000E000 - 000000000000E07F]	RAID Controller
	[000000000000E000 - 000000000000EFFF]	Intel(R) 100 Series/C230 Series Chipset Family PCI Express Root Port #4 - A113
	[000000000000E000 - 000000000000EFFF]	Mobile 6th Generation Intel(R) Processor Family I/O PCI Express Root Port #1 - 9D10
	[000000000000E000 - 000000000000EFFF]	PCI Express Root Port
	[000000000000E000 - 000000000000EFFF]	PCI Express Root Port
	[000000000000F000 - 000000000000F03F]	Intel(R) HD Graphics 520
	[000000000000F000 - 000000000000F03F]	Intel(R) HD Graphics 530
	[000000000000F040 - 000000000000F05F]	Intel(R) 100 Series/C230 Series Chipset Family SMBus - A123
	[000000000000F040 - 000000000000F05F]	Mobile 6th Generation Intel(R) Processor Family I/O SMBUS - 9D23
	[000000000000F060 - 000000000000F07F]	Standard SATA AHCI Controller
	[000000000000F060 - 000000000000F07F]	Standard SATA AHCI Controller
	[000000000000F080 - 000000000000F083]	Standard SATA AHCI Controller
	[000000000000F080 - 000000000000F083]	Standard SATA AHCI Controller
	[000000000000F090 - 000000000000F097]	Standard SATA AHCI Controller
	[000000000000F090 - 000000000000F097]	Standard SATA AHCI Controller
	[000000000000FF00 - 000000000000FFFF]	Motherboard resources
	[000000000000FFFF - 000000000000FFFF]	Motherboard resources
	[000000000000FFFF - 000000000000FFFF]	Motherboard resources
	[000000000000FFFF - 000000000000FFFF]	Motherboard resources
>		Interrupt request (IRQ)
>		Memory







































B.2 Memory Address Map

















































Address Range	Device Name
[0000000000A0000 - 0000000000BFFFFF]	Intel(R) HD Graphics 530
[0000000000A0000 - 0000000000BFFFFF]	PCI Express Root Complex
[0000000090000000 - 00000000DFFFFFFF]	PCI Express Root Complex
[00000000C0000000 - 00000000CFFFFFFF]	Intel(R) HD Graphics 520
[00000000C0000000 - 00000000CFFFFFFF]	Intel(R) HD Graphics 530
[00000000DE000000 - 00000000DEFFFFFF]	Intel(R) HD Graphics 520
[00000000DE000000 - 00000000DEFFFFFF]	Intel(R) HD Graphics 530
[00000000DF000000 - 00000000DF01FFFF]	Intel(R) I210 Gigabit Network Connection #3
[00000000DF000000 - 00000000DF01FFFF]	Intel(R) 100 Series/C230 Series Chipset Family PCI Express Root Port #13 - A11C
[00000000DF000000 - 00000000DF01FFFF]	Mobile 6th Generation Intel(R) Processor Family I/O PCI Express Root Port #1 - 9D10
[00000000DF020000 - 00000000DF023FFF]	Intel(R) I210 Gigabit Network Connection #3
[00000000DF100000 - 00000000DF10FFFF]	High Definition Audio Controller
[00000000DF100000 - 00000000DF11FFFF]	Intel(R) I210 Gigabit Network Connection #2
[00000000DF100000 - 00000000DF11FFFF]	Intel(R) 100 Series/C230 Series Chipset Family PCI Express Root Port #12 - A11B
[00000000DF110000 - 00000000DF11FFFF]	Intel(R) USB 3.0 eXtensible Host Controller - 1.0 (Microsoft)
[00000000DF120000 - 00000000DF123FFF]	High Definition Audio Controller
[00000000DF120000 - 00000000DF123FFF]	Intel(R) I210 Gigabit Network Connection #2
[00000000DF124000 - 00000000DF127FFF]	Mobile 6th Generation Intel(R) Processor Family I/O PMC - 9D21
[00000000DF128000 - 00000000DF129FFF]	Standard SATA AHCI Controller
[00000000DF12A000 - 00000000DF12A0FF]	Mobile 6th Generation Intel(R) Processor Family I/O SMBUS - 9D23
[00000000DF12B000 - 00000000DF12B7FF]	Standard SATA AHCI Controller
[00000000DF12C000 - 00000000DF12C0FF]	Standard SATA AHCI Controller
[00000000DF12E000 - 00000000DF12EFFF]	Mobile 6th Generation Intel(R) Processor Family I/O Thermal subsystem - 9D31
[00000000DF200000 - 00000000DF21FFFF]	Intel(R) I210 Gigabit Network Connection
[00000000DF200000 - 00000000DF21FFFF]	Intel(R) 100 Series/C230 Series Chipset Family PCI Express Root Port #4 - A113
[00000000DF220000 - 00000000DF223FFF]	Intel(R) I210 Gigabit Network Connection
[00000000DF300000 - 00000000DF30FFFF]	High Definition Audio Controller
[00000000DF300000 - 00000000DF31FFFF]	PCI Express Root Port
[00000000DF300000 - 00000000DF31FFFF]	PCI Express Root Port
[00000000DF310000 - 00000000DF31FFFF]	Intel(R) USB 3.0 eXtensible Host Controller - 1.0 (Microsoft)
[00000000DF320000 - 00000000DF323FFF]	High Definition Audio Controller
[00000000DF324000 - 00000000DF327FFF]	Intel(R) 100 Series/C230 Series Chipset Family PMC - A121
[00000000DF328000 - 00000000DF329FFF]	Standard SATA AHCI Controller
[00000000DF32A000 - 00000000DF32A0FF]	Intel(R) 100 Series/C230 Series Chipset Family SMBus - A123
[00000000DF32B000 - 00000000DF32B7FF]	Standard SATA AHCI Controller
[00000000DF32C000 - 00000000DF32C0FF]	Standard SATA AHCI Controller
[00000000DF32E000 - 00000000DF32EFFF]	Intel(R) 100 Series/C230 Series Chipset Family Thermal subsystem - A131
[00000000DF380000 - 00000000DF383FFF]	RAID Controller
[00000000DF380000 - 00000000DF383FFF]	RAID Controller
[00000000DF384000 - 00000000DF38407F]	RAID Controller
[00000000DF384000 - 00000000DF38407F]	RAID Controller
[00000000DFFE0000 - 00000000DFFFFFFF]	Motherboard resources
[00000000E0000000 - 00000000EFFFFFFF]	Motherboard resources
[00000000FD000000 - 00000000FDABFFFF]	Motherboard resources
[00000000FD000000 - 00000000FE7FFFFF]	PCI Express Root Complex
[00000000FDAC0000 - 00000000FDACFFFF]	Motherboard resources
[00000000FDAD0000 - 00000000FDADFFFF]	Motherboard resources
[00000000FDAE0000 - 00000000FDAEFFFF]	Motherboard resources















































	[00000000FDAF0000 - 00000000FDAFFFFFF]	Motherboard resources
	[00000000FDB00000 - 00000000FDFFFFFF]	Motherboard resources
	[00000000FE000000 - 00000000FE01FFFF]	Motherboard resources
	[00000000FE036000 - 00000000FE03BFFF]	Motherboard resources
	[00000000FE03D000 - 00000000FE3FFFFFF]	Motherboard resources
	[00000000FE40F000 - 00000000FE40FFFF]	Intel(R) Management Engine Interface
	[00000000FE410000 - 00000000FE7FFFFFF]	Motherboard resources
	[00000000FED00000 - 00000000FED003FF]	High precision event timer
	[00000000FED10000 - 00000000FED17FFF]	Motherboard resources
	[00000000FED18000 - 00000000FED18FFF]	Motherboard resources
	[00000000FED19000 - 00000000FED19FFF]	Motherboard resources
	[00000000FED20000 - 00000000FED3FFFF]	Motherboard resources
	[00000000FED40000 - 00000000FED40FFF]	Trusted Platform Module 1.2
	[00000000FED45000 - 00000000FED8FFFF]	Motherboard resources
	[00000000FED90000 - 00000000FED93FFF]	Motherboard resources
	[00000000FEE00000 - 00000000FEEFFFFFF]	Motherboard resources
	[00000000FF000000 - 00000000FFFFFFFF]	Legacy device
	[00000000FF000000 - 00000000FFFFFFFF]	Legacy device
	[00000000FF000000 - 00000000FFFFFFFF]	Motherboard resources

















































B.3 IRQ Mapping Chart















































Interrupt request (IRQ)	
(ISA) 0x00000000 (00)	System timer
(ISA) 0x00000000 (00)	System timer
(ISA) 0x00000001 (01)	Standard PS/2 Keyboard
(ISA) 0x00000003 (03)	Communications Port (COM2)
(ISA) 0x00000004 (04)	Communications Port (COM1)
(ISA) 0x00000005 (05)	High Definition Audio Controller
(ISA) 0x00000005 (05)	Intel(R) HD Graphics 520
(ISA) 0x00000005 (05)	Intel(R) USB 3.0 eXtensible Host Controller - 1.0 (Microsoft)
(ISA) 0x00000005 (05)	Mobile 6th Generation Intel(R) Processor Family I/O SMBUS - 9D23
(ISA) 0x00000005 (05)	Mobile 6th Generation Intel(R) Processor Family I/O PCI Express Root Port #1 - 9D10
(ISA) 0x00000005 (05)	PCI Express Root Port
(ISA) 0x00000005 (05)	RAID Controller
(ISA) 0x00000005 (05)	Standard SATA AHCI Controller
(ISA) 0x00000006 (06)	Mobile 6th Generation Intel(R) Processor Family I/O Thermal subsystem - 9D31
(ISA) 0x00000008 (08)	System CMOS/real time clock
(ISA) 0x00000008 (08)	System CMOS/real time clock
(ISA) 0x0000000A (10)	PCI Express Root Port
(ISA) 0x0000000A (10)	RAID Controller
(ISA) 0x0000000B (11)	Communications Port (COM3)
(ISA) 0x0000000B (11)	Communications Port (COM4)
(ISA) 0x0000000B (11)	Communications Port (COM5)
(ISA) 0x0000000B (11)	Communications Port (COM6)
(ISA) 0x0000000C (12)	PS/2 Compatible Mouse
(ISA) 0x0000000D (13)	Numeric data processor
(ISA) 0x0000000E (14)	Motherboard resources
(ISA) 0x00000036 (54)	Microsoft ACPI-Compliant System
(ISA) 0x00000037 (55)	Microsoft ACPI-Compliant System
(ISA) 0x00000038 (56)	Microsoft ACPI-Compliant System
(ISA) 0x00000039 (57)	Microsoft ACPI-Compliant System
(ISA) 0x0000003A (58)	Microsoft ACPI-Compliant System
(ISA) 0x0000003B (59)	Microsoft ACPI-Compliant System
(ISA) 0x0000003C (60)	Microsoft ACPI-Compliant System
(ISA) 0x0000003D (61)	Microsoft ACPI-Compliant System
(ISA) 0x0000003E (62)	Microsoft ACPI-Compliant System
(ISA) 0x0000003F (63)	Microsoft ACPI-Compliant System
(ISA) 0x00000040 (64)	Microsoft ACPI-Compliant System
(ISA) 0x00000041 (65)	Microsoft ACPI-Compliant System
(ISA) 0x00000042 (66)	Microsoft ACPI-Compliant System
(ISA) 0x00000043 (67)	Microsoft ACPI-Compliant System
(ISA) 0x00000044 (68)	Microsoft ACPI-Compliant System
(ISA) 0x00000045 (69)	Microsoft ACPI-Compliant System
(ISA) 0x00000046 (70)	Microsoft ACPI-Compliant System
(ISA) 0x00000047 (71)	Microsoft ACPI-Compliant System
(ISA) 0x00000048 (72)	Microsoft ACPI-Compliant System
(ISA) 0x00000049 (73)	Microsoft ACPI-Compliant System
(ISA) 0x0000004A (74)	Microsoft ACPI-Compliant System
(ISA) 0x0000004B (75)	Microsoft ACPI-Compliant System
(ISA) 0x0000004C (76)	Microsoft ACPI-Compliant System

















































 (ISA) 0x0000004D (77)	Microsoft ACPI-Compliant System
 (ISA) 0x0000004E (78)	Microsoft ACPI-Compliant System
 (ISA) 0x0000004F (79)	Microsoft ACPI-Compliant System
 (ISA) 0x00000050 (80)	Microsoft ACPI-Compliant System
 (ISA) 0x00000051 (81)	Microsoft ACPI-Compliant System
 (ISA) 0x00000052 (82)	Microsoft ACPI-Compliant System
 (ISA) 0x00000053 (83)	Microsoft ACPI-Compliant System
 (ISA) 0x00000054 (84)	Microsoft ACPI-Compliant System
 (ISA) 0x00000055 (85)	Microsoft ACPI-Compliant System
 (ISA) 0x00000056 (86)	Microsoft ACPI-Compliant System
 (ISA) 0x00000057 (87)	Microsoft ACPI-Compliant System
 (ISA) 0x00000058 (88)	Microsoft ACPI-Compliant System
 (ISA) 0x00000059 (89)	Microsoft ACPI-Compliant System
 (ISA) 0x0000005A (90)	Microsoft ACPI-Compliant System
 (ISA) 0x0000005B (91)	Microsoft ACPI-Compliant System
 (ISA) 0x0000005C (92)	Microsoft ACPI-Compliant System
 (ISA) 0x0000005D (93)	Microsoft ACPI-Compliant System
 (ISA) 0x0000005E (94)	Microsoft ACPI-Compliant System
 (ISA) 0x0000005F (95)	Microsoft ACPI-Compliant System
 (ISA) 0x00000060 (96)	Microsoft ACPI-Compliant System
 (ISA) 0x00000061 (97)	Microsoft ACPI-Compliant System
 (ISA) 0x00000062 (98)	Microsoft ACPI-Compliant System
 (ISA) 0x00000063 (99)	Microsoft ACPI-Compliant System
 (ISA) 0x00000064 (100)	Microsoft ACPI-Compliant System
 (ISA) 0x00000065 (101)	Microsoft ACPI-Compliant System
 (ISA) 0x00000066 (102)	Microsoft ACPI-Compliant System
 (ISA) 0x00000067 (103)	Microsoft ACPI-Compliant System
 (ISA) 0x00000068 (104)	Microsoft ACPI-Compliant System
 (ISA) 0x00000069 (105)	Microsoft ACPI-Compliant System
 (ISA) 0x0000006A (106)	Microsoft ACPI-Compliant System
 (ISA) 0x0000006B (107)	Microsoft ACPI-Compliant System
 (ISA) 0x0000006C (108)	Microsoft ACPI-Compliant System
 (ISA) 0x0000006D (109)	Microsoft ACPI-Compliant System
 (ISA) 0x0000006E (110)	Microsoft ACPI-Compliant System
 (ISA) 0x0000006F (111)	Microsoft ACPI-Compliant System
 (ISA) 0x00000070 (112)	Microsoft ACPI-Compliant System
 (ISA) 0x00000071 (113)	Microsoft ACPI-Compliant System
 (ISA) 0x00000072 (114)	Microsoft ACPI-Compliant System
(ISA) 0x00000073 (115)	Microsoft ACPI-Compliant System
(ISA) 0x00000074 (116)	Microsoft ACPI-Compliant System
(ISA) 0x00000075 (117)	Microsoft ACPI-Compliant System
(ISA) 0x00000076 (118)	Microsoft ACPI-Compliant System
(ISA) 0x00000077 (119)	Microsoft ACPI-Compliant System
(ISA) 0x00000078 (120)	Microsoft ACPI-Compliant System
(ISA) 0x00000079 (121)	Microsoft ACPI-Compliant System
(ISA) 0x0000007A (122)	Microsoft ACPI-Compliant System
(ISA) 0x0000007B (123)	Microsoft ACPI-Compliant System
(ISA) 0x0000007C (124)	Microsoft ACPI-Compliant System
(ISA) 0x0000007D (125)	Microsoft ACPI-Compliant System

















































 (ISA) 0x0000007E (126)	Microsoft ACPI-Compliant System
 (ISA) 0x0000007F (127)	Microsoft ACPI-Compliant System
 (ISA) 0x00000080 (128)	Microsoft ACPI-Compliant System
 (ISA) 0x00000081 (129)	Microsoft ACPI-Compliant System
 (ISA) 0x00000082 (130)	Microsoft ACPI-Compliant System
 (ISA) 0x00000083 (131)	Microsoft ACPI-Compliant System
 (ISA) 0x00000084 (132)	Microsoft ACPI-Compliant System
 (ISA) 0x00000085 (133)	Microsoft ACPI-Compliant System
 (ISA) 0x00000086 (134)	Microsoft ACPI-Compliant System
 (ISA) 0x00000087 (135)	Microsoft ACPI-Compliant System
 (ISA) 0x00000088 (136)	Microsoft ACPI-Compliant System
 (ISA) 0x00000089 (137)	Microsoft ACPI-Compliant System
 (ISA) 0x0000008A (138)	Microsoft ACPI-Compliant System
 (ISA) 0x0000008B (139)	Microsoft ACPI-Compliant System
 (ISA) 0x0000008C (140)	Microsoft ACPI-Compliant System
 (ISA) 0x0000008D (141)	Microsoft ACPI-Compliant System
 (ISA) 0x0000008E (142)	Microsoft ACPI-Compliant System
 (ISA) 0x0000008F (143)	Microsoft ACPI-Compliant System
 (ISA) 0x00000090 (144)	Microsoft ACPI-Compliant System
 (ISA) 0x00000091 (145)	Microsoft ACPI-Compliant System
 (ISA) 0x00000092 (146)	Microsoft ACPI-Compliant System
 (ISA) 0x00000093 (147)	Microsoft ACPI-Compliant System
 (ISA) 0x00000094 (148)	Microsoft ACPI-Compliant System
 (ISA) 0x00000095 (149)	Microsoft ACPI-Compliant System
 (ISA) 0x00000096 (150)	Microsoft ACPI-Compliant System
 (ISA) 0x00000097 (151)	Microsoft ACPI-Compliant System
 (ISA) 0x00000098 (152)	Microsoft ACPI-Compliant System
 (ISA) 0x00000099 (153)	Microsoft ACPI-Compliant System
 (ISA) 0x0000009A (154)	Microsoft ACPI-Compliant System
 (ISA) 0x0000009B (155)	Microsoft ACPI-Compliant System
 (ISA) 0x0000009C (156)	Microsoft ACPI-Compliant System
 (ISA) 0x0000009D (157)	Microsoft ACPI-Compliant System
 (ISA) 0x0000009E (158)	Microsoft ACPI-Compliant System
 (ISA) 0x0000009F (159)	Microsoft ACPI-Compliant System
 (ISA) 0x000000A0 (160)	Microsoft ACPI-Compliant System
 (ISA) 0x000000A1 (161)	Microsoft ACPI-Compliant System
 (ISA) 0x000000A2 (162)	Microsoft ACPI-Compliant System
 (ISA) 0x000000A3 (163)	Microsoft ACPI-Compliant System
 (ISA) 0x000000A4 (164)	Microsoft ACPI-Compliant System
 (ISA) 0x000000A5 (165)	Microsoft ACPI-Compliant System
 (ISA) 0x000000A6 (166)	Microsoft ACPI-Compliant System
 (ISA) 0x000000A7 (167)	Microsoft ACPI-Compliant System
 (ISA) 0x000000A8 (168)	Microsoft ACPI-Compliant System
 (ISA) 0x000000A9 (169)	Microsoft ACPI-Compliant System
 (ISA) 0x000000AA (170)	Microsoft ACPI-Compliant System
 (ISA) 0x000000AB (171)	Microsoft ACPI-Compliant System
 (ISA) 0x000000AC (172)	Microsoft ACPI-Compliant System
 (ISA) 0x000000AD (173)	Microsoft ACPI-Compliant System
 (ISA) 0x000000AE (174)	Microsoft ACPI-Compliant System

















































 (ISA) 0x000000AF (175)	Microsoft ACPI-Compliant System
 (ISA) 0x000000B0 (176)	Microsoft ACPI-Compliant System
 (ISA) 0x000000B1 (177)	Microsoft ACPI-Compliant System
 (ISA) 0x000000B2 (178)	Microsoft ACPI-Compliant System
 (ISA) 0x000000B3 (179)	Microsoft ACPI-Compliant System
 (ISA) 0x000000B4 (180)	Microsoft ACPI-Compliant System
 (ISA) 0x000000B5 (181)	Microsoft ACPI-Compliant System
 (ISA) 0x000000B6 (182)	Microsoft ACPI-Compliant System
 (ISA) 0x000000B7 (183)	Microsoft ACPI-Compliant System
 (ISA) 0x000000B8 (184)	Microsoft ACPI-Compliant System
 (ISA) 0x000000B9 (185)	Microsoft ACPI-Compliant System
 (ISA) 0x000000BA (186)	Microsoft ACPI-Compliant System
 (ISA) 0x000000BB (187)	Microsoft ACPI-Compliant System
 (ISA) 0x000000BC (188)	Microsoft ACPI-Compliant System
 (ISA) 0x000000BD (189)	Microsoft ACPI-Compliant System
 (ISA) 0x000000BE (190)	Microsoft ACPI-Compliant System
 (ISA) 0x000000BF (191)	Microsoft ACPI-Compliant System
 (ISA) 0x000000C0 (192)	Microsoft ACPI-Compliant System
 (ISA) 0x000000C1 (193)	Microsoft ACPI-Compliant System
 (ISA) 0x000000C2 (194)	Microsoft ACPI-Compliant System
 (ISA) 0x000000C3 (195)	Microsoft ACPI-Compliant System
 (ISA) 0x000000C4 (196)	Microsoft ACPI-Compliant System
 (ISA) 0x000000C5 (197)	Microsoft ACPI-Compliant System
 (ISA) 0x000000C6 (198)	Microsoft ACPI-Compliant System
 (ISA) 0x000000C7 (199)	Microsoft ACPI-Compliant System
 (ISA) 0x000000C8 (200)	Microsoft ACPI-Compliant System
 (ISA) 0x000000C9 (201)	Microsoft ACPI-Compliant System
 (ISA) 0x000000CA (202)	Microsoft ACPI-Compliant System
 (ISA) 0x000000CB (203)	Microsoft ACPI-Compliant System
 (ISA) 0x000000CC (204)	Microsoft ACPI-Compliant System
 (ISA) 0x00000100 (256)	Microsoft ACPI-Compliant System
 (ISA) 0x00000101 (257)	Microsoft ACPI-Compliant System
 (ISA) 0x00000102 (258)	Microsoft ACPI-Compliant System
 (ISA) 0x00000103 (259)	Microsoft ACPI-Compliant System
 (ISA) 0x00000104 (260)	Microsoft ACPI-Compliant System
 (ISA) 0x00000105 (261)	Microsoft ACPI-Compliant System
 (ISA) 0x00000106 (262)	Microsoft ACPI-Compliant System
 (ISA) 0x00000107 (263)	Microsoft ACPI-Compliant System
 (ISA) 0x00000108 (264)	Microsoft ACPI-Compliant System
 (ISA) 0x00000109 (265)	Microsoft ACPI-Compliant System
 (ISA) 0x0000010A (266)	Microsoft ACPI-Compliant System
 (ISA) 0x0000010B (267)	Microsoft ACPI-Compliant System
 (ISA) 0x0000010C (268)	Microsoft ACPI-Compliant System
 (ISA) 0x0000010D (269)	Microsoft ACPI-Compliant System
 (ISA) 0x0000010E (270)	Microsoft ACPI-Compliant System
 (ISA) 0x0000010F (271)	Microsoft ACPI-Compliant System
 (ISA) 0x00000110 (272)	Microsoft ACPI-Compliant System
(ISA) 0x00000111 (273)	Microsoft ACPI-Compliant System
(ISA) 0x00000112 (274)	Microsoft ACPI-Compliant System























	(ISA) 0x00000113 (275)	Microsoft ACPI-Compliant System
	(ISA) 0x00000114 (276)	Microsoft ACPI-Compliant System
	(ISA) 0x00000115 (277)	Microsoft ACPI-Compliant System
	(ISA) 0x00000116 (278)	Microsoft ACPI-Compliant System
	(ISA) 0x00000117 (279)	Microsoft ACPI-Compliant System
	(ISA) 0x00000118 (280)	Microsoft ACPI-Compliant System
	(ISA) 0x00000119 (281)	Microsoft ACPI-Compliant System
	(ISA) 0x0000011A (282)	Microsoft ACPI-Compliant System
	(ISA) 0x0000011B (283)	Microsoft ACPI-Compliant System
	(ISA) 0x0000011C (284)	Microsoft ACPI-Compliant System
	(ISA) 0x0000011D (285)	Microsoft ACPI-Compliant System
	(ISA) 0x0000011E (286)	Microsoft ACPI-Compliant System
	(ISA) 0x0000011F (287)	Microsoft ACPI-Compliant System
	(ISA) 0x00000120 (288)	Microsoft ACPI-Compliant System
	(ISA) 0x00000121 (289)	Microsoft ACPI-Compliant System
	(ISA) 0x00000122 (290)	Microsoft ACPI-Compliant System
	(ISA) 0x00000123 (291)	Microsoft ACPI-Compliant System
	(ISA) 0x00000124 (292)	Microsoft ACPI-Compliant System
	(ISA) 0x00000125 (293)	Microsoft ACPI-Compliant System
	(ISA) 0x00000126 (294)	Microsoft ACPI-Compliant System
	(ISA) 0x00000127 (295)	Microsoft ACPI-Compliant System
	(ISA) 0x00000128 (296)	Microsoft ACPI-Compliant System
	(ISA) 0x00000129 (297)	Microsoft ACPI-Compliant System
	(ISA) 0x0000012A (298)	Microsoft ACPI-Compliant System
	(ISA) 0x0000012B (299)	Microsoft ACPI-Compliant System
	(ISA) 0x0000012C (300)	Microsoft ACPI-Compliant System
	(ISA) 0x0000012D (301)	Microsoft ACPI-Compliant System
	(ISA) 0x0000012E (302)	Microsoft ACPI-Compliant System
	(ISA) 0x0000012F (303)	Microsoft ACPI-Compliant System
	(ISA) 0x00000130 (304)	Microsoft ACPI-Compliant System
	(ISA) 0x00000131 (305)	Microsoft ACPI-Compliant System
	(ISA) 0x00000132 (306)	Microsoft ACPI-Compliant System
	(ISA) 0x00000133 (307)	Microsoft ACPI-Compliant System
	(ISA) 0x00000134 (308)	Microsoft ACPI-Compliant System
	(ISA) 0x00000135 (309)	Microsoft ACPI-Compliant System
	(ISA) 0x00000136 (310)	Microsoft ACPI-Compliant System
	(ISA) 0x00000137 (311)	Microsoft ACPI-Compliant System
	(ISA) 0x00000138 (312)	Microsoft ACPI-Compliant System
	(ISA) 0x00000139 (313)	Microsoft ACPI-Compliant System
	(ISA) 0x0000013A (314)	Microsoft ACPI-Compliant System
	(ISA) 0x0000013B (315)	Microsoft ACPI-Compliant System
	(ISA) 0x0000013C (316)	Microsoft ACPI-Compliant System
	(ISA) 0x0000013D (317)	Microsoft ACPI-Compliant System
	(ISA) 0x0000013E (318)	Microsoft ACPI-Compliant System
	(ISA) 0x0000013F (319)	Microsoft ACPI-Compliant System
	(ISA) 0x00000140 (320)	Microsoft ACPI-Compliant System
	(ISA) 0x00000141 (321)	Microsoft ACPI-Compliant System
	(ISA) 0x00000142 (322)	Microsoft ACPI-Compliant System
	(ISA) 0x00000143 (323)	Microsoft ACPI-Compliant System

 (ISA) 0x00000144 (324)	Microsoft ACPI-Compliant System
 (ISA) 0x00000145 (325)	Microsoft ACPI-Compliant System
 (ISA) 0x00000146 (326)	Microsoft ACPI-Compliant System
 (ISA) 0x00000147 (327)	Microsoft ACPI-Compliant System
 (ISA) 0x00000148 (328)	Microsoft ACPI-Compliant System
 (ISA) 0x00000149 (329)	Microsoft ACPI-Compliant System
 (ISA) 0x0000014A (330)	Microsoft ACPI-Compliant System
 (ISA) 0x0000014B (331)	Microsoft ACPI-Compliant System
 (ISA) 0x0000014C (332)	Microsoft ACPI-Compliant System
 (ISA) 0x0000014D (333)	Microsoft ACPI-Compliant System
 (ISA) 0x0000014E (334)	Microsoft ACPI-Compliant System
 (ISA) 0x0000014F (335)	Microsoft ACPI-Compliant System
 (ISA) 0x00000150 (336)	Microsoft ACPI-Compliant System
 (ISA) 0x00000151 (337)	Microsoft ACPI-Compliant System
 (ISA) 0x00000152 (338)	Microsoft ACPI-Compliant System
 (ISA) 0x00000153 (339)	Microsoft ACPI-Compliant System
 (ISA) 0x00000154 (340)	Microsoft ACPI-Compliant System
 (ISA) 0x00000155 (341)	Microsoft ACPI-Compliant System
 (ISA) 0x00000156 (342)	Microsoft ACPI-Compliant System
 (ISA) 0x00000157 (343)	Microsoft ACPI-Compliant System
 (ISA) 0x00000158 (344)	Microsoft ACPI-Compliant System
 (ISA) 0x00000159 (345)	Microsoft ACPI-Compliant System
 (ISA) 0x0000015A (346)	Microsoft ACPI-Compliant System
 (ISA) 0x0000015B (347)	Microsoft ACPI-Compliant System
 (ISA) 0x0000015C (348)	Microsoft ACPI-Compliant System
 (ISA) 0x0000015D (349)	Microsoft ACPI-Compliant System
 (ISA) 0x0000015E (350)	Microsoft ACPI-Compliant System
 (ISA) 0x0000015F (351)	Microsoft ACPI-Compliant System
 (ISA) 0x00000160 (352)	Microsoft ACPI-Compliant System
 (ISA) 0x00000161 (353)	Microsoft ACPI-Compliant System
 (ISA) 0x00000162 (354)	Microsoft ACPI-Compliant System
 (ISA) 0x00000163 (355)	Microsoft ACPI-Compliant System
 (ISA) 0x00000164 (356)	Microsoft ACPI-Compliant System
 (ISA) 0x00000165 (357)	Microsoft ACPI-Compliant System
 (ISA) 0x00000166 (358)	Microsoft ACPI-Compliant System
 (ISA) 0x00000167 (359)	Microsoft ACPI-Compliant System
 (ISA) 0x00000168 (360)	Microsoft ACPI-Compliant System
 (ISA) 0x00000169 (361)	Microsoft ACPI-Compliant System
 (ISA) 0x0000016A (362)	Microsoft ACPI-Compliant System
 (ISA) 0x0000016B (363)	Microsoft ACPI-Compliant System
 (ISA) 0x0000016C (364)	Microsoft ACPI-Compliant System
 (ISA) 0x0000016D (365)	Microsoft ACPI-Compliant System
 (ISA) 0x0000016E (366)	Microsoft ACPI-Compliant System
 (ISA) 0x0000016F (367)	Microsoft ACPI-Compliant System
 (ISA) 0x00000170 (368)	Microsoft ACPI-Compliant System
 (ISA) 0x00000171 (369)	Microsoft ACPI-Compliant System
 (ISA) 0x00000172 (370)	Microsoft ACPI-Compliant System
(ISA) 0x00000173 (371)	Microsoft ACPI-Compliant System
(ISA) 0x00000174 (372)	Microsoft ACPI-Compliant System

 (ISA) 0x00000175 (373)	Microsoft ACPI-Compliant System
 (ISA) 0x00000176 (374)	Microsoft ACPI-Compliant System
 (ISA) 0x00000177 (375)	Microsoft ACPI-Compliant System
 (ISA) 0x00000178 (376)	Microsoft ACPI-Compliant System
 (ISA) 0x00000179 (377)	Microsoft ACPI-Compliant System
 (ISA) 0x0000017A (378)	Microsoft ACPI-Compliant System
 (ISA) 0x0000017B (379)	Microsoft ACPI-Compliant System
 (ISA) 0x0000017C (380)	Microsoft ACPI-Compliant System
 (ISA) 0x0000017D (381)	Microsoft ACPI-Compliant System
 (ISA) 0x0000017E (382)	Microsoft ACPI-Compliant System
 (ISA) 0x0000017F (383)	Microsoft ACPI-Compliant System
 (ISA) 0x00000180 (384)	Microsoft ACPI-Compliant System
 (ISA) 0x00000181 (385)	Microsoft ACPI-Compliant System
 (ISA) 0x00000182 (386)	Microsoft ACPI-Compliant System
 (ISA) 0x00000183 (387)	Microsoft ACPI-Compliant System
 (ISA) 0x00000184 (388)	Microsoft ACPI-Compliant System
 (ISA) 0x00000185 (389)	Microsoft ACPI-Compliant System
 (ISA) 0x00000186 (390)	Microsoft ACPI-Compliant System
 (ISA) 0x00000187 (391)	Microsoft ACPI-Compliant System
 (ISA) 0x00000188 (392)	Microsoft ACPI-Compliant System
 (ISA) 0x00000189 (393)	Microsoft ACPI-Compliant System
 (ISA) 0x0000018A (394)	Microsoft ACPI-Compliant System
 (ISA) 0x0000018B (395)	Microsoft ACPI-Compliant System
 (ISA) 0x0000018C (396)	Microsoft ACPI-Compliant System
 (ISA) 0x0000018D (397)	Microsoft ACPI-Compliant System
 (ISA) 0x0000018E (398)	Microsoft ACPI-Compliant System
 (ISA) 0x0000018F (399)	Microsoft ACPI-Compliant System
 (ISA) 0x00000190 (400)	Microsoft ACPI-Compliant System
 (ISA) 0x00000191 (401)	Microsoft ACPI-Compliant System
 (ISA) 0x00000192 (402)	Microsoft ACPI-Compliant System
 (ISA) 0x00000193 (403)	Microsoft ACPI-Compliant System
 (ISA) 0x00000194 (404)	Microsoft ACPI-Compliant System
 (ISA) 0x00000195 (405)	Microsoft ACPI-Compliant System
 (ISA) 0x00000196 (406)	Microsoft ACPI-Compliant System
 (ISA) 0x00000197 (407)	Microsoft ACPI-Compliant System
 (ISA) 0x00000198 (408)	Microsoft ACPI-Compliant System
 (ISA) 0x00000199 (409)	Microsoft ACPI-Compliant System
 (ISA) 0x0000019A (410)	Microsoft ACPI-Compliant System
 (ISA) 0x0000019B (411)	Microsoft ACPI-Compliant System
 (ISA) 0x0000019C (412)	Microsoft ACPI-Compliant System
 (ISA) 0x0000019D (413)	Microsoft ACPI-Compliant System
 (ISA) 0x0000019E (414)	Microsoft ACPI-Compliant System
 (ISA) 0x0000019F (415)	Microsoft ACPI-Compliant System
 (ISA) 0x000001A0 (416)	Microsoft ACPI-Compliant System
 (ISA) 0x000001A1 (417)	Microsoft ACPI-Compliant System
 (ISA) 0x000001A2 (418)	Microsoft ACPI-Compliant System
 (ISA) 0x000001A3 (419)	Microsoft ACPI-Compliant System
 (ISA) 0x000001A4 (420)	Microsoft ACPI-Compliant System
 (ISA) 0x000001A5 (421)	Microsoft ACPI-Compliant System

 (ISA) 0x000001A6 (422)	Microsoft ACPI-Compliant System
 (ISA) 0x000001A7 (423)	Microsoft ACPI-Compliant System
 (ISA) 0x000001A8 (424)	Microsoft ACPI-Compliant System
 (ISA) 0x000001A9 (425)	Microsoft ACPI-Compliant System
 (ISA) 0x000001AA (426)	Microsoft ACPI-Compliant System
 (ISA) 0x000001AB (427)	Microsoft ACPI-Compliant System
 (ISA) 0x000001AC (428)	Microsoft ACPI-Compliant System
 (ISA) 0x000001AD (429)	Microsoft ACPI-Compliant System
 (ISA) 0x000001AE (430)	Microsoft ACPI-Compliant System
 (ISA) 0x000001AF (431)	Microsoft ACPI-Compliant System
 (ISA) 0x000001B0 (432)	Microsoft ACPI-Compliant System
 (ISA) 0x000001B1 (433)	Microsoft ACPI-Compliant System
 (ISA) 0x000001B2 (434)	Microsoft ACPI-Compliant System
 (ISA) 0x000001B3 (435)	Microsoft ACPI-Compliant System
 (ISA) 0x000001B4 (436)	Microsoft ACPI-Compliant System
 (ISA) 0x000001B5 (437)	Microsoft ACPI-Compliant System
 (ISA) 0x000001B6 (438)	Microsoft ACPI-Compliant System
 (ISA) 0x000001B7 (439)	Microsoft ACPI-Compliant System
 (ISA) 0x000001B8 (440)	Microsoft ACPI-Compliant System
 (ISA) 0x000001B9 (441)	Microsoft ACPI-Compliant System
 (ISA) 0x000001BA (442)	Microsoft ACPI-Compliant System
 (ISA) 0x000001BB (443)	Microsoft ACPI-Compliant System
 (ISA) 0x000001BC (444)	Microsoft ACPI-Compliant System
 (ISA) 0x000001BD (445)	Microsoft ACPI-Compliant System
 (ISA) 0x000001BE (446)	Microsoft ACPI-Compliant System
 (ISA) 0x000001BF (447)	Microsoft ACPI-Compliant System
 (ISA) 0x000001C0 (448)	Microsoft ACPI-Compliant System
 (ISA) 0x000001C1 (449)	Microsoft ACPI-Compliant System
 (ISA) 0x000001C2 (450)	Microsoft ACPI-Compliant System
 (ISA) 0x000001C3 (451)	Microsoft ACPI-Compliant System
 (ISA) 0x000001C4 (452)	Microsoft ACPI-Compliant System
 (ISA) 0x000001C5 (453)	Microsoft ACPI-Compliant System
 (ISA) 0x000001C6 (454)	Microsoft ACPI-Compliant System
 (ISA) 0x000001C7 (455)	Microsoft ACPI-Compliant System
 (ISA) 0x000001C8 (456)	Microsoft ACPI-Compliant System
 (ISA) 0x000001C9 (457)	Microsoft ACPI-Compliant System
 (ISA) 0x000001CA (458)	Microsoft ACPI-Compliant System
 (ISA) 0x000001CB (459)	Microsoft ACPI-Compliant System
 (ISA) 0x000001CC (460)	Microsoft ACPI-Compliant System
 (ISA) 0x000001CD (461)	Microsoft ACPI-Compliant System
 (ISA) 0x000001CE (462)	Microsoft ACPI-Compliant System
 (ISA) 0x000001CF (463)	Microsoft ACPI-Compliant System
 (ISA) 0x000001D0 (464)	Microsoft ACPI-Compliant System
 (ISA) 0x000001D1 (465)	Microsoft ACPI-Compliant System
 (ISA) 0x000001D2 (466)	Microsoft ACPI-Compliant System
 (ISA) 0x000001D3 (467)	Microsoft ACPI-Compliant System
 (ISA) 0x000001D4 (468)	Microsoft ACPI-Compliant System
 (ISA) 0x000001D5 (469)	Microsoft ACPI-Compliant System
 (ISA) 0x000001D6 (470)	Microsoft ACPI-Compliant System

 (ISA) 0x00001D7 (471)	Microsoft ACPI-Compliant System
 (ISA) 0x00001D8 (472)	Microsoft ACPI-Compliant System
 (ISA) 0x00001D9 (473)	Microsoft ACPI-Compliant System
 (ISA) 0x00001DA (474)	Microsoft ACPI-Compliant System
 (ISA) 0x00001DB (475)	Microsoft ACPI-Compliant System
 (ISA) 0x00001DC (476)	Microsoft ACPI-Compliant System
 (ISA) 0x00001DD (477)	Microsoft ACPI-Compliant System
 (ISA) 0x00001DE (478)	Microsoft ACPI-Compliant System
 (ISA) 0x00001DF (479)	Microsoft ACPI-Compliant System
 (ISA) 0x00001E0 (480)	Microsoft ACPI-Compliant System
 (ISA) 0x00001E1 (481)	Microsoft ACPI-Compliant System
 (ISA) 0x00001E2 (482)	Microsoft ACPI-Compliant System
 (ISA) 0x00001E3 (483)	Microsoft ACPI-Compliant System
 (ISA) 0x00001E4 (484)	Microsoft ACPI-Compliant System
 (ISA) 0x00001E5 (485)	Microsoft ACPI-Compliant System
 (ISA) 0x00001E6 (486)	Microsoft ACPI-Compliant System
 (ISA) 0x00001E7 (487)	Microsoft ACPI-Compliant System
 (ISA) 0x00001E8 (488)	Microsoft ACPI-Compliant System
 (ISA) 0x00001E9 (489)	Microsoft ACPI-Compliant System
 (ISA) 0x00001EA (490)	Microsoft ACPI-Compliant System
 (ISA) 0x00001EB (491)	Microsoft ACPI-Compliant System
 (ISA) 0x00001EC (492)	Microsoft ACPI-Compliant System
 (ISA) 0x00001ED (493)	Microsoft ACPI-Compliant System
 (ISA) 0x00001EE (494)	Microsoft ACPI-Compliant System
 (ISA) 0x00001EF (495)	Microsoft ACPI-Compliant System
 (ISA) 0x00001F0 (496)	Microsoft ACPI-Compliant System
 (ISA) 0x00001F1 (497)	Microsoft ACPI-Compliant System
 (ISA) 0x00001F2 (498)	Microsoft ACPI-Compliant System
 (ISA) 0x00001F3 (499)	Microsoft ACPI-Compliant System
 (ISA) 0x00001F4 (500)	Microsoft ACPI-Compliant System
 (ISA) 0x00001F5 (501)	Microsoft ACPI-Compliant System
 (ISA) 0x00001F6 (502)	Microsoft ACPI-Compliant System
 (ISA) 0x00001F7 (503)	Microsoft ACPI-Compliant System
 (ISA) 0x00001F8 (504)	Microsoft ACPI-Compliant System
 (ISA) 0x00001F9 (505)	Microsoft ACPI-Compliant System
 (ISA) 0x00001FA (506)	Microsoft ACPI-Compliant System
 (ISA) 0x00001FB (507)	Microsoft ACPI-Compliant System
 (ISA) 0x00001FC (508)	Microsoft ACPI-Compliant System
 (ISA) 0x00001FD (509)	Microsoft ACPI-Compliant System
 (ISA) 0x00001FE (510)	Microsoft ACPI-Compliant System
 (ISA) 0x00001FF (511)	Microsoft ACPI-Compliant System
 (PCI) 0x00000005 (05)	Intel(R) 100 Series/C230 Series Chipset Family SMBus - A123
 (PCI) 0x0000000A (10)	Intel(R) 100 Series/C230 Series Chipset Family Thermal subsystem - A131
 (PCI) 0x00000010 (16)	High Definition Audio Controller
 (PCI) 0xFFFFFE4 (-28)	Intel(R) Management Engine Interface
 (PCI) 0xFFFFFE5 (-27)	Intel(R) I210 Gigabit Network Connection #3
 (PCI) 0xFFFFFE6 (-26)	Intel(R) I210 Gigabit Network Connection #3
 (PCI) 0xFFFFFE7 (-25)	Intel(R) I210 Gigabit Network Connection #3
 (PCI) 0xFFFFFE8 (-24)	Intel(R) I210 Gigabit Network Connection #3

	(PCI) 0xFFFFFEE9 (-23)	Intel(R) I210 Gigabit Network Connection #3
	(PCI) 0xFFFFFEEA (-22)	Intel(R) I210 Gigabit Network Connection #3
	(PCI) 0xFFFFFEEB (-21)	Intel(R) I210 Gigabit Network Connection #2
	(PCI) 0xFFFFFEEC (-20)	Intel(R) I210 Gigabit Network Connection #2
	(PCI) 0xFFFFFEED (-19)	Intel(R) I210 Gigabit Network Connection #2
	(PCI) 0xFFFFFEEE (-18)	Intel(R) I210 Gigabit Network Connection #2
	(PCI) 0xFFFFFEF (-17)	Intel(R) I210 Gigabit Network Connection #2
	(PCI) 0xFFFFFEF0 (-16)	Intel(R) I210 Gigabit Network Connection #2
	(PCI) 0xFFFFFEF1 (-15)	Intel(R) I210 Gigabit Network Connection
	(PCI) 0xFFFFFEF2 (-14)	Intel(R) I210 Gigabit Network Connection
	(PCI) 0xFFFFFEF3 (-13)	Intel(R) I210 Gigabit Network Connection
	(PCI) 0xFFFFFEF4 (-12)	Intel(R) I210 Gigabit Network Connection
	(PCI) 0xFFFFFEF5 (-11)	Intel(R) I210 Gigabit Network Connection
	(PCI) 0xFFFFFEF6 (-10)	Intel(R) I210 Gigabit Network Connection
	(PCI) 0xFFFFFEF7 (-9)	Intel(R) USB 3.0 eXtensible Host Controller - 1.0 (Microsoft)
	(PCI) 0xFFFFFEF8 (-8)	Intel(R) HD Graphics 530
	(PCI) 0xFFFFFEF9 (-7)	Standard SATA AHCI Controller
	(PCI) 0xFFFFFEFA (-6)	Intel(R) 100 Series/C230 Series Chipset Family PCI Express Root Port #13 - A11C
	(PCI) 0xFFFFFEFB (-5)	Intel(R) 100 Series/C230 Series Chipset Family PCI Express Root Port #12 - A11B
	(PCI) 0xFFFFFEFC (-4)	Intel(R) 100 Series/C230 Series Chipset Family PCI Express Root Port #9 - A118
	(PCI) 0xFFFFFEFD (-3)	Intel(R) 100 Series/C230 Series Chipset Family PCI Express Root Port #4 - A113
	(PCI) 0xFFFFFEFE (-2)	Intel(R) 100 Series/C230 Series Chipset Family PCI Express Root Port #1 - A110

Appendix C

Digital I/O Information

C.1 DIO Programming

BOXER-6639 utilizes FINTEK F75113 chipset as its Digital I/O controller.

Below are the procedures to complete its configuration which you can develop customized program to fit your application.

C.2 DIO Register

Table 1 : SuperIO relative register table

	Default Value	Note
Index	0x2E(Note1)	SIO MB PnP Mode Index Register 0x2E or 0x4E
Data	0x2F(Note2)	SIO MB PnP Mode Data Register 0x2F or 0x4F
LDN	0x07(Note3)	

Table 2 : Digital I/O relative register table

	Register				
	Input Register (Note4)	BitNum	Output Register (Note5)	BitNum	Note
DIO-1 Pin	0x12	0	0x13	0	GPIO00
DIO-2 Pin	0x12	1	0x13	1	GPIO01
DIO-3 Pin	0x12	2	0x13	2	GPIO02
DIO-4 Pin	0x12	3	0x13	3	GPIO03
DIO-5 Pin	0x12	4	0x13	4	GPIO04
DIO-6 Pin	0x12	5	0x13	5	GPIO05
DIO-7 Pin	0x12	6	0x13	6	GPIO06
DIO-8 Pin	0x12	7	0x13	7	GPIO07
DIO-9 Pin	0x22	0	0x23	0	GPIO10
DIO-10 Pin	0x22	1	0x23	1	GPIO11
DIO-11 Pin	0x22	2	0x23	2	GPIO12
DIO-12 Pin	0x22	3	0x23	3	GPIO13
DIO-13 Pin	0x22	4	0x23	4	GPIO14
DIO-14 Pin	0x22	5	0x23	5	GPIO15
DIO-15 Pin	0x22	6	0x23	6	GPIO16
DIO-16 Pin	0x22	7	0x23	7	GPIO17
DIO-17 Pin	0x32	0	0x33	0	GPIO20
DIO-18 Pin	0x32	1	0x33	1	GPIO21
DIO-19 Pin	0x32	2	0x33	2	GPIO22
DIO-20 Pin	0x32	3	0x33	3	GPIO23
DIO-21 Pin	0x32	4	0x33	4	GPIO24
DIO-22 Pin	0x32	5	0x33	5	GPIO25
DIO-23 Pin	0x32	6	0x33	6	GPIO26
DIO-24 Pin	0x32	7	0x33	7	GPIO27

DIO-25 Pin	0x42	0	0x43	0	GPIO30
DIO-26 Pin	0x42	1	0x43	1	GPIO31
DIO-27 Pin	0x42	2	0x43	2	GPIO32
DIO-28 Pin	0x42	3	0x43	3	GPIO33
DIO-29 Pin	0x42	4	0x43	4	GPIO34
DIO-30 Pin	0x42	5	0x43	5	GPIO35
DIO-31 Pin	0x42	6	0x43	6	GPIO36
DIO-32 Pin	0x42	7	0x43	7	GPIO37
DIO-33 Pin	0x72	0	0x73	0	GPIO40
DIO-34 Pin	0x72	1	0x73	1	GPIO41

C.3 DIO Sample Program

```
*****
// SuperIO relative definition (Please reference to Table 1)
#define byte   SIOIndex //This parameter is represented from Note1
#define byte   SIOData //This parameter is represented from Note2
#define void   IOWriteByte(byte IOPort, byte Value);
#define byte   IOReadByte(byte IOPort);
// Digital Input Status relative definition (Please reference to Table 2)
#define byte   DInputLDN // This parameter is represented from Note3
#define byte   DInputReg // This parameter is represented from Note4
#define byte   DInputBit // This parameter is represented from Note5
*****

*****
VOID Main() {
    Boolean PinStatus ;

    // Procedure : AaeonReadPinStatus
    // Input :
    //     Example, Read Digital I/O Pin 3 status
    // Output :
    //     InputStatus :
    //         0: Digital I/O Pin level is low
    //         1: Digital I/O Pin level is High
    PinStatus = AaeonReadPinStatus(DInputLDN, DInputReg, DInputBit);

    // Procedure : AaeonSetOutputLevel
    // Input :
    //     Example, Set Digital I/O Pin 6 level
    AaeonSetOutputLevel(DOutputLDN, DOutputReg, DOutputBit, DOutputVal);
}

```

```
*****
Boolean  AaeonReadPinStatus(byte LDN, byte Register, byte BitNum){
    Boolean PinStatus ;

    PinStatus = SIOBitRead(LDN, Register, BitNum);
    Return PinStatus ;
}
VOID  AaeonSetOutputLevel(byte LDN, byte Register, byte BitNum, byte Value){
    ConfigToOutputMode(LDN, Register, BitNum);
    SIOBitSet(LDN, Register, BitNum, Value);
}
*****
```

```
*****
VOID SIOEnterMBPnPMode(){
    IOWriteByte(SIOIndex, 0x87);
    IOWriteByte(SIOIndex, 0x87);
}

VOID SIOExitMBPnPMode(){
    IOWriteByte(SIOIndex, 0xAA);
}

VOID SIOSelectLDN(byte LDN){
    IOWriteByte(SIOIndex, 0x07); // SIO LDN Register Offset = 0x07
    IOWriteByte(SIOData, LDN);
}

VOID SIOBitSet(byte LDN, byte Register, byte BitNum, byte Value){
    Byte TmpValue;

    SIOEnterMBPnPMode();
    SIOSelectLDN(byte LDN);
    IOWriteByte(SIOIndex, Register);
    TmpValue = IOReadByte(SIOData);
    TmpValue &= ~(1 << BitNum);
    TmpValue |= (Value << BitNum);
    IOWriteByte(SIOData, TmpValue);
    SIOExitMBPnPMode();
}

VOID SIOByteSet(byte LDN, byte Register, byte Value){
    SIOEnterMBPnPMode();
    SIOSelectLDN(LDN);
    IOWriteByte(SIOIndex, Register);
    IOWriteByte(SIOData, Value);
    SIOExitMBPnPMode();
}
*****
```

```
*****
Boolean SIOBitRead(byte LDN, byte Register, byte BitNum){
    Byte TmpValue;

    SIOEnterMBPnPMode();
    SIOSelectLDN(LDN);
    IOWriteByte(SIOIndex, Register);
    TmpValue = IOReadByte(SIOData);
    TmpValue &= (1 << BitNum);
    SIOExitMBPnPMode();
    If(TmpValue == 0)
        Return 0;
    Return 1;
}
VOID ConfigToOutputMode(byte LDN, byte Register, byte BitNum){
    Byte TmpValue, OutputEnableReg;

    OutputEnableReg = Register-1;
    SIOEnterMBPnPMode();
    SIOSelectLDN(LDN);
    IOWriteByte(SIOIndex, OutputEnableReg);
    TmpValue = IOReadByte(SIOData);
    TmpValue |= (1 << BitNum);
    IOWriteByte(SIOData, OutputEnableReg);
    SIOExitMBPnPMode();
}
*****
```