

BOXER-6617-ADN

Fanless Embedded Box PC

User's Manual 1st Ed

Copyright Notice

This document is copyrighted, 2023. All rights are reserved. The original manufacturer reserves the right to make improvements to the products described in this manual at any time without notice.

No part of this manual may be reproduced, copied, translated, or transmitted in any form or by any means without the prior written permission of the original manufacturer. Information provided in this manual is intended to be accurate and reliable. However, the original manufacturer assumes no responsibility for its use, or for any infringements upon the rights of third parties that may result from its use.

The material in this document is for product information only and is subject to change without notice. While reasonable efforts have been made in the preparation of this document to assure its accuracy, AAEON assumes no liabilities resulting from errors or omissions in this document, or from the use of the information contained herein.

AAEON reserves the right to make changes in the product design without notice to its users.

Acknowledgement

All other product name or trademarks are properties of their respective owners.

- Microsoft Windows® is a registered trademark of Microsoft Corp.
- Intel® and Atom® are registered trademarks of Intel Corporation
- Intel® Core™ is a trademark of Intel Corporation
- Linux® is the registered trademark of Linus Torvalds in the U.S. and other countries
- Ubuntu and Canonical are registered trademarks of Canonical Ltd.

All other product names or trademarks are properties of their respective owners. The publisher of this document does not assume nor imply ownership of any trademarked product not listed herein.

Packing List

Before setting up your product, please make sure the following items have been shipped:

Item	Quantity
● BOXER-6617-ADN	1
● Wallmount Bracket	2
● Screw Package	1
● 3 Pin DC-In Power Connector	1

If any of these items are missing or damaged, please contact your distributor or sales representative immediately.

About this Document

This User's Manual contains all the essential information, such as detailed descriptions and explanations on the product's hardware and software features (if any), its specifications, dimensions, jumper/connector settings/definitions, and driver installation instructions (if any), to facilitate users in setting up their product.

Users may refer to the product page at AAEON.com for the latest version of this document.

Safety Precautions

Please read the following safety instructions carefully. It is advised that you keep this manual for future references

1. All cautions and warnings on the device should be noted.
2. Make sure the power source matches the power rating of the device.
3. Position the power cord so that people cannot step on it. Do not place anything over the power cord.
4. Always completely disconnect the power before working on the system's hardware.
5. No connections should be made when the system is powered as a sudden rush of power may damage sensitive electronic components.
6. If the device is not to be used for a long time, disconnect it from the power supply to avoid damage by transient over-voltage.
7. Always disconnect this device from any power supply before cleaning.
8. While cleaning, use a damp cloth instead of liquid or spray detergents.
9. Make sure the device is installed near a power outlet and is easily accessible.
10. Keep this device away from humidity.
11. Place the device on a solid surface during installation to prevent falls.
12. Do not cover the openings on the device to ensure optimal heat dissipation.
13. Watch out for high temperatures when the system is running.
14. Do not touch the heat sink or heat spreader when the system is running
15. Never pour any liquid into the openings. This could cause fire or electric shock.
16. As most electronic components are sensitive to static electrical charge, be sure to ground yourself to prevent static charge when installing the internal components. Use a grounding wrist strap and contain all electronic components in any static-shielded containers.

17. If any of the following situations arises, please contact our service personnel:
 - i. Damaged power cord or plug
 - ii. Liquid intrusion to the device
 - iii. Exposure to moisture
 - iv. Device is not working as expected or in a manner as described in this manual
 - v. The device is dropped or damaged
 - vi. Any obvious signs of damage displayed on the device
18. Do not leave this device in an uncontrolled environment with temperatures beyond the device's permitted storage temperatures (see chapter 1) to prevent damage.
19. Do NOT disassemble the motherboard so as not to damage the system or void your warranty.
20. If the thermal pad had been damaged, please contact AAEON's salesperson to purchase a new one. Do NOT use those of other brands.
21. The Hex Cylinder Coppers on the front panel are not removable.
22. Repeatedly assemble and disassemble the system may cause damages to the exterior paint and surface and screw holes.
23. Use the right size screwdriver.
24. Use the screwdriver correctly to remove screws from the system.

FCC Statement

Warning!



This device complies with Part 15 FCC Rules. Operation is subject to the following two conditions: (1) this device may not cause harmful interference, and (2) this device must accept any interference received including interference that may cause undesired operation.

Caution:

There is a danger of explosion if the battery is incorrectly replaced. Replace only with the same or equivalent type recommended by the manufacturer. Dispose of used batteries according to the manufacturer's instructions and your local government's recycling or disposal directives.

Attention:

Il y a un risque d'explosion si la batterie est remplacée de façon incorrecte. Ne la remplacer qu'avec le même modèle ou équivalent recommandé par le constructeur. Recycler les batteries usées en accord avec les instructions du fabricant et les directives gouvernementales de recyclage.

产品中有毒有害物质或元素名称及含量

AAEON System

QO4-381 Rev.A0

部件名称	有毒有害物质或元素					
	铅 (Pb)	汞 (Hg)	镉 (Cd)	六价铬 (Cr(VI))	多溴联苯 (PBB)	多溴二苯 醚(PBDE)
印刷电路板 及其电子组件	×	○	○	○	○	○
外部信号 连接器及线材	×	○	○	○	○	○
外壳	○	○	○	○	○	○
中央处理器 与内存	×	○	○	○	○	○
硬盘	×	○	○	○	○	○
液晶模块	×	×	○	○	○	○
光驱	×	○	○	○	○	○
触控模块	×	○	○	○	○	○
电源	×	○	○	○	○	○
电池	×	○	○	○	○	○

本表格依据 SJ/T 11364 的规定编制。

○：表示该有毒有害物质在该部件所有均质材料中的含量均在 GB/T 26572 标准规定的限量要求以下。

×：表示该有害物质的某一均质材料超出了 GB/T 26572 的限量要求，然而该部件

仍符合欧盟指令 2011/65/EU 的规范。

备注：

- 一、此产品所标示之环保使用期限，系指在一般正常使用状况下。
- 二、上述部件物质中央处理器、内存、硬盘、光驱、电源为选购品。
- 三、上述部件物质液晶模块、触控模块仅一体机产品适用。

Hazardous and Toxic Materials List

AAEON System

QO4-381 Rev.A0

Component Name	Hazardous or Toxic Materials or Elements					
	Lead (Pb)	Mercury (Hg)	Cadmium (Cd)	Hexavalent Chromium (Cr(VI))	Polybrominated biphenyls (PBBS)	Polybrominated diphenyl ethers (PBDES)
PCB and Components	X	O	O	O	O	O
Wires & Connectors for Ext.Connections	X	O	O	O	O	O
Chassis	O	O	O	O	O	O
CPU & RAM	X	O	O	O	O	O
HDD Drive	X	O	O	O	O	O
LCD Module	X	X	O	O	O	O
Optical Drive	X	O	O	O	O	O
Touch Control Module	X	O	O	O	O	O
PSU	X	O	O	O	O	O
Battery	X	O	O	O	O	O

This form is prepared in compliance with the provisions of SJ/T 11364.

O: The level of toxic or hazardous materials present in this component and its parts is below the limit specified by GB/T 26572.

X: The level of toxic of hazardous materials present in the component exceed the limits specified by GB/T 26572, but is still in compliance with EU Directive 2011/65/EU (RoHS 2).

Notes:

1. The Environment Friendly Use Period indicated by labelling on this product is applicable only to use under normal conditions.
2. Individual components including the CPU, RAM/memory, HDD, optical drive, and PSU are optional.
3. LCD Module and Touch Control Module only applies to certain products which feature these components.

Table of Contents

Chapter 1 - Product Specifications	1
1.1 Specifications.....	2
Chapter 2 – Hardware Information	4
2.1 Dimensions	5
2.2 Jumpers and Connectors	6
2.3 List of Jumpers	7
2.3.1 Setting Jumpers.....	7
2.3.2 Auto Power Button Selection (JP1)	8
2.3.3 CMOS (JP2)	8
2.4 List of Connectors	9
2.4.1 HDMI Port (CN2).....	11
2.4.2 M.2 2230 E-Key (CN3)	13
2.4.3 M.2 3052 B-Key (CN4).....	15
2.4.4 SIM Card Slot (CN5)	17
2.4.5 LAN Port (CN6)	17
2.4.6 LAN Port (CN7)	18
2.4.7 M.2 2280 M-Key (CN8).....	19
2.4.8 Reset Button Wafer (Reserve) (CN9)	21
2.4.9 Power Button Wafer (Reserve) (CN10)	21
2.4.10 Dual USB 3.2 Port (CN11).....	22
2.4.11 Dual USB 2.0 Port (CN12/CN13).....	23
2.4.12 COM 2 Wafer (Optional) (CN14).....	23
2.4.13 COM 1 Wafer (Optional) (CN16)	24
2.4.14 COM 3 Wafer (Optional) (CN17).....	25
2.4.15 COM 4 Wafer (Optional) (CN18).....	26
2.4.16 Dual DB-9 Port (COM 1 + COM 2) (CN15).....	27

2.4.17	Dual DB-9 Port (COM 3 + COM 4) (CN19)	28
2.4.18	Dual DB-9 Port (COM 5 + COM 6) (CN20).....	29
2.4.19	SPI Flash Wafer (CN21)	29
2.4.20	eSPI Wafer (CN22).....	30
2.4.21	SATA Connector (CN23)	31
2.4.22	SATA Power (CN24)	31
2.4.23	DIO Wafer (CN25)	32
2.4.24	DB-15 Port (DIO) (CN26).....	32
2.4.25	Audio Connector (CN27)	33
2.4.26	Terminal 3-Pin Power Input (CN29)	34
2.5	Memory RAM Module Installation	35
2.6	2.5" SATA Drive Installation.....	38
2.7	DIN Rail Installation.....	40
Chapter 3 - AMI BIOS Setup.....		41
3.1	System Test and Initialization	42
3.2	AMI BIOS Setup.....	43
3.3	Setup Submenu: Main.....	44
3.4	Setup Submenu: Advanced	45
3.4.1	CPU Configuration	46
3.4.2	Memory Configuration.....	47
3.4.3	PCH-FW Configuration.....	48
3.4.3.1	Firmware Update Configuration	49
3.4.4	Hardware Monitor	50
3.4.5	Power Management.....	51
3.4.6	AAEON BIOS Robot.....	52
3.4.6.1	Device Detecting Configuration	54
3.5	Setup Submenu: System I/O.....	60
3.5.1	Storage Configuration	61

3.5.2	HD Audio Configuration	62
3.5.3	Digital IO Port Configuration	63
3.5.4	Legacy Logical Devices Configuration	65
3.5.4.1	Serial Port 1	66
3.5.4.2	Serial Port 2	67
3.5.4.3	Serial Port 3	68
3.5.4.4	Serial Port 4	69
3.5.4.5	Serial Port 5	70
3.5.4.6	Serial Port 6	71
3.5.5	Legacy Logical Devices Configuration	72
3.5.5.1	Console Redirection Settings (COM0)	73
3.5.5.2	Console Redirection Settings (Out-of-Band Mgmt)	75
3.6	Setup Submenu: Security	77
3.6.1	Trusted Computing	78
3.6.2	Secure Boot	80
3.6.2.1	Key Management	81
3.7	Setup Submenu: Boot	83
3.7.1	UEFI BBS Priorities	84
3.8	Setup Submenu: Save & Exit	85
Chapter 4 – Drivers Installation		86
4.1	Drivers Download and Installation	87
Appendix A - I/O Information		89
A.1	I/O Address Map	90
A.2	Memory Address Map	91
A.3	IRQ Mapping Chart	92

Chapter 1

Product Specifications

1.1 Specifications

System

CPU	Intel Atom® Processor X Series, Intel® Core™ i3, and Intel® Processor N-series Processors: Intel® Processor N50 Intel® Processor N97 Intel® Core™ i3-N305 Intel Atom® x7211E
Chipset	Intel® SoC
System Memory	DDR5 4800MHz SODIMM x 1, up to 32GB
Display Interface	HDMI 2.0 x 2
Storage Device	2.5" SATA HDD/SSD Bay M.2 2280 M-Key x 1 for PCIe SSD (PCIe [x2])
Ethernet	Intel® I226-LM, 2.5GbE Base-TX x 2
I/O	USB 3.2 Gen 2 x 2 USB 2.0 x 4 MIC-in x 1, Line-out x 1 DB-9 x 6 for RS-232/422/485 SMA Antenna Hole x 6 DB-15 for 8-bit DIO
Expansion	M.2 2230 E-Key x 1 for Wi-Fi M.2 3052 B-Key x 1 for 4G/5G
Indicator	System/Storage
OS Support	Windows® 10 IoT Enterprise 64-bit Linux Ubuntu 22.04

Power Supply

Power Requirement 9 ~ 36V 3-pin DC Input

Mechanical

Mounting Wallmount

Dimensions (W x D x H) 8.42" x 4.54" x 2.59" (214mm x 115.5mm x 65.8mm)

Gross Weight 6.17 lb. (2.8Kg)

Net Weight 4.4 lb. (2Kg)

Environmental

Operating Temperature -4 F ~158°F (-20°C ~ 70°C), IEC68-2 with 0.5 m/s AirFlow, with Wide Temperature Memory/Storage

Storage Temperature -40°F ~ 176°F (-40°C ~ 80°C)

Storage Humidity 5 ~ 95% at 40°C, non-condensing

Anti-Vibration 3 Grms/ 5 ~ 500Hz/ operation – with SSD 50G, IEC68-2-27, half sine, 11ms duration (with SSD)

Certification CE/FCC Class A

Chapter 2

Hardware Information

2.1 Dimensions

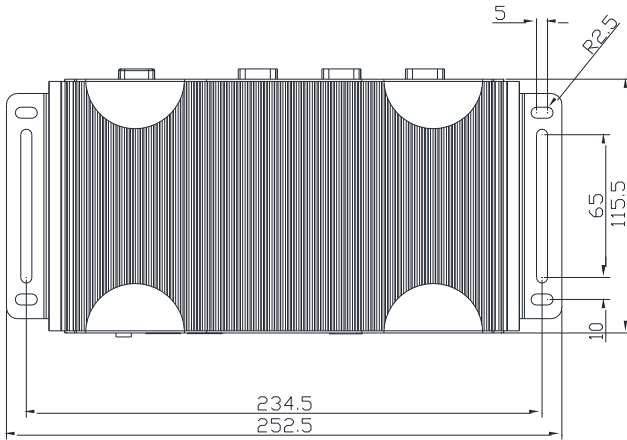
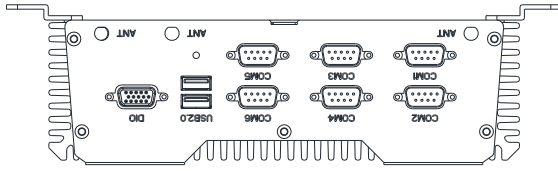

Unit:mm

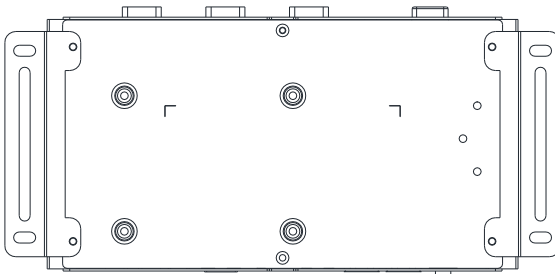
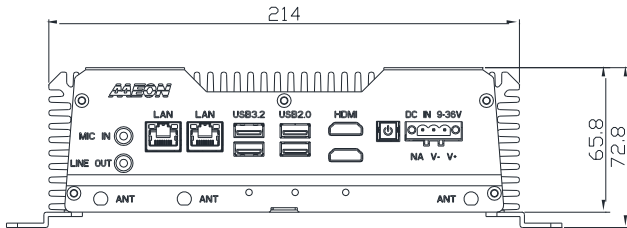
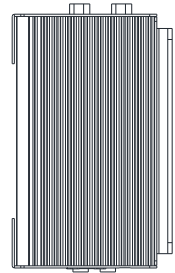

2.2 Jumpers and Connectors

Note: Board dimensions are 185mm x 112mm x 1.8mm.

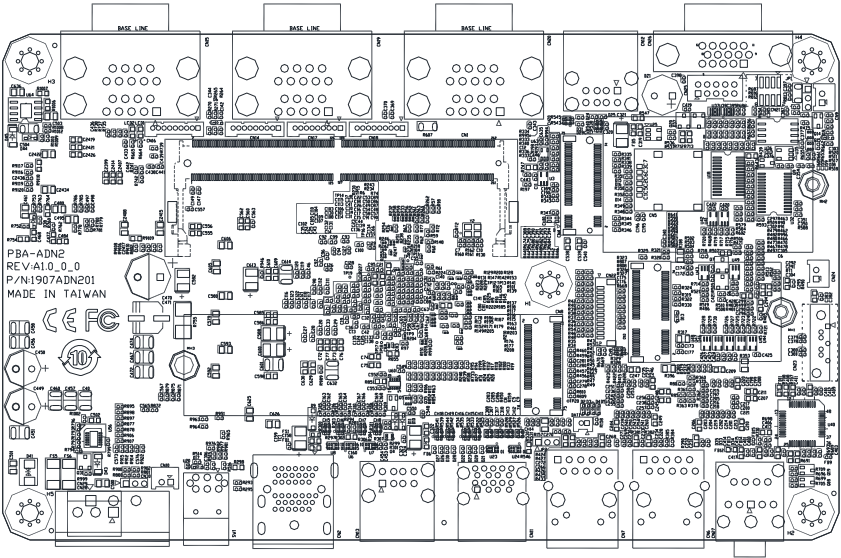

2.3 List of Jumpers

Please refer to the table below for all of the system's jumpers that you can configure for your application.

Label	Function
JP1	Auto Power Button Selection
JP2	Clear CMOS

2.3.1 Setting Jumpers

The BOXER-6617-ADN comes with several jumpers which allow you to configure the system by either setting the jumper to "open" or "closed"; or by selecting certain pins. A closed jumper has two pins connected with a jumper clip, while an open jumper has no pins connected.

For jumpers with multiple pins, this guide uses "pins A-B" to notate which pins should be connected by a jumper clip. For example, "pins 1-2" means you should connect pins 1 and 2, while "pins 2-3" means you should connect pins 2 and 3.

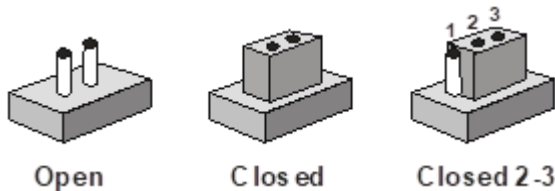

A pair of needle-nose pliers may be helpful when working with jumpers.

If you have any questions about how best to configure the system for your application, contact your AAEON representative or visit our website to talk with our support team.

2.3.2 Auto Power Button Selection (JP1)

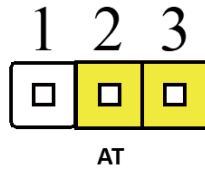
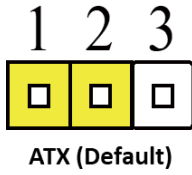

Note: Disable Auto Power Button JP1 (1-2) requires user to use power button JP1 (1-2) to power on the system.

2.3.3 CMOS (JP2)

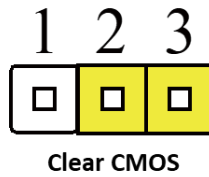
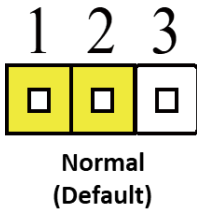

2.4 List of Connectors

Please refer to the table below for all of the system's connectors that you can configure for your application

Label	Function
CN2	HDMI Port
CN3	M.2 2230 E-Key
CN4	M.2 3052 B-Key
CN5	SIM Card Slot
CN6	LAN Port
CN7	LAN Port
CN8	M.2 2280 M-Key
CN9	Reset Button Wafer (Reserve)
CN10	Power Button Wafer (Reserve)
CN11	Dual USB 3.2 Port
CN12	Dual USB 2.0 Port
CN13	Dual USB 2.0 Port
CN14	COM 2 Wafer
CN15	Dual DB-9 Port (COM 1 + COM 2)
CN16	COM 1 Wafer
CN17	COM 3 Wafer
CN18	COM 4 Wafer
CN19	Dual DB-9 Port (COM 3 + COM 4)
CN20	Dual DB-9 Port (COM 5 + COM 6)
CN21	SPI Flash Wafer
CN22	eSPI Wafer
CN23	SATA Connector

Label	Function
CN24	SATA Power
CN25	DIO Wafer
CN26	DB-15 Port (DIO)
CN27	Audio (Mic-In + Line-Out)
CN29	Terminal 3-Pin Power Input
SW1	Power Button

2.4.1 HDMI Port (CN2)

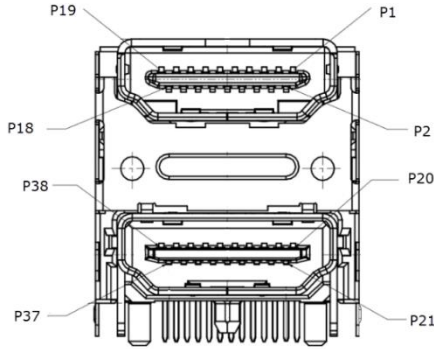

Pin	Signal	Signal Type	Signal Level
P1	HDMI1_DATA2_P	DIFF	
P2	GND	GND	
P3	HDMI1_DATA2_N	DIFF	
P4	HDMI1_DATA1_P	DIFF	
P5	GND	GND	
P6	HDMI1_DATA1_N	DIFF	
P7	HDMI1_DATA0_P	DIFF	
P8	GND	GND	
P9	HDMI1_DATA0_n	DIFF	
P10	HDMI1_CLK_P	DIFF	
P11	GND	GND	
P12	HDMI1_CLK_N	DIFF	
P13	NC		
P14	NC		
P15	HDMI1_SCL		
P16	HDMI1_SDA		
P17	GND	GND	
P18	+V5S_HDMI_CON	PWR	5V

Pin	Signal	Signal Type	Signal Level
P19	HDMI1_HPD		5V
P20	HDMI2_DATA2_P	DIFF	
P21	GND	GND	
P22	HDMI2_DATA2_N	DIFF	
P23	HDMI2_DATA1_P	DIFF	
P24	GND	GND	
P25	HDMI2_DATA1_N	DIFF	
P26	HDMI2_DATA0_P	DIFF	
P27	GND	GND	
P28	HDMI2_DATA0_N	DIFF	
P29	HDMI2_CLK_P	DIFF	
P30	GND	GND	
P31	HDMI2_CLK_N		
P32	NC		
P33	NC		
P34	HDMI2_SCL		
P35	HDMI2_SDA		
P36	GND	GND	
P37	+V5S_HDMI_CON		5V
P38	HDMI2_HPD		5V

Note: Standard specification.

Pin	Pin Name	Signal Type	Pin	Pin Name	Signal Type	Signal level
35	PCIE_TXP	DIFF	36	NC		
37	PCIE_TXN	DIFF	38	NC		
39	GND	GND	40	NC		
41	PCIE_RXP	DIFF	42	NC		
43	PCIE_RXN	DIFF	44	NC		
45	GND	GND	46	NC		
47	PCIE_CLK_P	DIFF	48	NC		
49	PCIE_CLK_N	DIFF	50	SUSCLK		
51	GND	GND	52	RESET	IN	
53	PCIE_M2E_CLKREQ#	OUT	54	W_DISABLE2#		
55	WAKE	OUT	56	W_DISABLE1#		
57	GND	GND	58	NC		
59	NC		60	NC		
61	NC		62	NC		
63	GND	GND	64	NC		
65	NC		66	NC		
67	NC		68	NC		
69	GND	GND	70	NC		
71	NC		72	+3.3V	PWR	+3.3V
73	NC		74	+3.3V	PWR	+3.3V
75	GND	GND				

2.4.3 M.2 3052 B-Key (CN4)

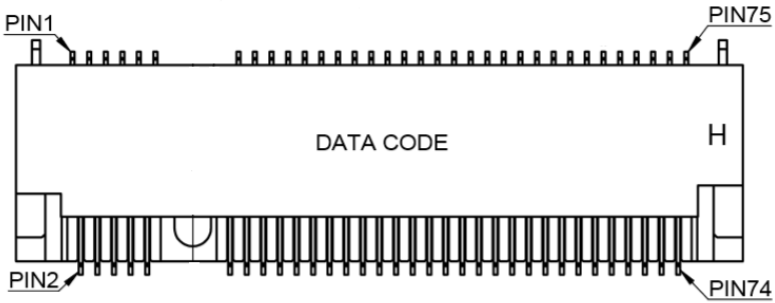

Pin	Pin Name	Signal Type	Pin	Pin Name	Signal Type	Signal level
1	NC		2	+3.3V	PWR	+3.3V
3	GND	GND	4	+3.3V	PWR	+3.3V
5	GND	GND	6	CARD_PWR_OFF_N	OUT	+3.3V
7	USB_2.0_P	DIFF	8	W_DISABLE	IN	+3.3V
9	USB_2.0_N	DIFF	10	NC		
11	GND	GND	12			
			20	NC		
21	NC		22	NC		
23	NC		24	NC		
25	NC		26	NC		
27	GND	GND	28	NC		
29	USB3_RXN	DIFF	30	UIM_RST		
31	USB3_RXP	DIFF	32	UIM_CLK		
33	GND	GND	34	UIM_DATA		
35	USB3_TXN	DIFF	36	UIM_PWR		

Pin	Pin Name	Signal Type	Pin	Pin Name	Signal Type	Signal level
37	USB3_TXP	DIFF	38	NC		
39	GND	GND	40	NC		
41	NC		42	NC		
43	NC		44	NC		
45	GND	GND	46	NC		
47	NC		48	NC		
49	NC		50	RESET#	IN	+3.3V
51	GND	GND	52	CLKREQ#	OUT	+3.3V
53	PCIE_M.2_CLK_N	DIFF	54	WAKE#	OUT	+3.3V
55	PCIE_M.2_CLK_P	DIFF	56	NC		
57	GND	GND	58	NC		
59	NC		60	NC		
61	NC		62	NC		
63	NC		64	NC		
65	NC		66	NC		
67	RESET#		68	SUSCLK		
69	NC		70	+3.3V	PWR	+3.3V
71	GND	GND	72	+3.3V	PWR	+3.3V
73	GND	GND	74	+3.3V	PWR	+3.3V
75	GND	GND				

2.4.4 SIM Card Slot (CN5)

Pin	Signal	Signal Type	Signal Level
1	UIM_PWR	PWR	
2	UIM_RST	IN	
3	UIM_CLK	IN	
4	GND	GND	
5	UIM_VPP	PWR	
6	UIM_DATA	I/O	

2.4.5 LAN Port (CN6)

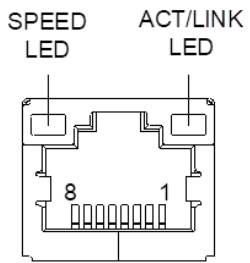

Pin	Signal	Signal Type	Signal Level
1	MDI0+	DIFF	
2	MDI0-	DIFF	
3	MDI1+	DIFF	
4	MDI1-	DIFF	
5	MDI2+	DIFF	
6	MDI2-	DIFF	
7	MDI3+	DIFF	
8	MDI3-	DIFF	

2.4.6 LAN Port (CN7)

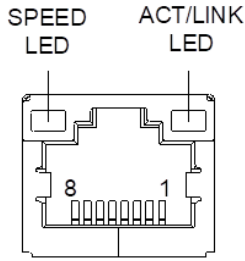

Pin	Signal	Signal Type	Signal Level
1	MDI0+	DIFF	
2	MDI0-	DIFF	
3	MDI1+	DIFF	
4	MDI1-	DIFF	
5	MDI2+	DIFF	
6	MDI2-	DIFF	
7	MDI3+	DIFF	
8	MDI3-	DIFF	

2.4.7 M.2 2280 M-Key (CN8)

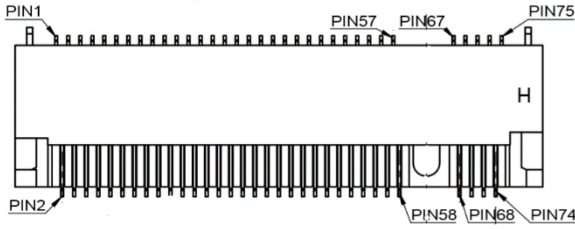

Pin	Pin Name	Signal Type	Pin	Pin Name	Signal Type	Signal level
1	GND	GND	2	+3.3V	PWR	+3.3V
3	GND	GND	4	+3.3V	PWR	+3.3V
5	NC		6	NC		
7	NC		8	NC		
9	GND	GND	10	NC		
11	NC		12	+3.3V	PWR	+3.3V
13	NC		14	+3.3V	PWR	+3.3V
15	GND	GND	16	+3.3V	PWR	+3.3V
17	NC		18	+3.3V	PWR	+3.3V
19	NC		20	NC		
21	GND	GND	22	NC		
23	NC		24	NC		
25	NC		26	NC		
27	GND	GND	28	NC		
29	PCIE_RXN10		30	NC		
31	PCIE_RXP10		32	NC		
33	GND	GND	34	NC		
35	PCIE_TXN10		36	NC		
37	PCIE_TXP10		38	NC		
39	GND	GND	40	NC		+1.8V

Pin	Pin Name	Signal Type	Pin	Pin Name	Signal Type	Signal level
41	PCIE_RXN9		42	NC		
43	PCIE_RXP9		44	NC		
45	GND	GND	46	NC		
47	PCIE_TXN9		48	NC		
49	PCIE_TXP9		50	PERST		
51	GND	GND	52	CLKREQ#	OUT	+3.3V
53	PCIE_M2M_CLKN	DIFF	54	WAKE#	OUT	+3.3V
55	PCIE_M2M_CLKP	DIFF	56	NC		
57	GND	GND	58	NC		
67	NC		68	NC		
69	NC		70	+3.3V	PWR	+3.3V
71	GND	GND	72	+3.3V	PWR	+3.3V
73	GND	GND	74	+3.3V	PWR	+3.3V
75	GND	GND				

2.4.8 Reset Button Wafer (Reserve) (CN9)



Pin	Signal
1	RESET
2	GND

2.4.9 Power Button Wafer (Reserve) (CN10)



Pin	Signal
1	PWR_BTN
2	GND

2.4.10 Dual USB 3.2 Port (CN11)

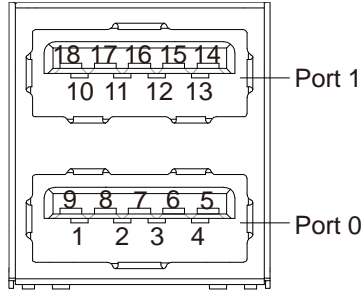

Pin	Signal	Signal Type	Signal Level
1	+5VSB	PWR	+5V
2	USB1_D-	DIFF	
3	USB1_D+	DIFF	
4	GND	GND	
5	USB1_SSRX-	DIFF	
6	USB1_SSRX+	DIFF	
7	GND	GND	
8	USB1_SSTX-	DIFF	
9	USB1_SSTX+	DIFF	
10	+5VSB	PWR	+5V
11	USB2_D-	DIFF	
12	USB2_D+	DIFF	
13	GND	GND	
14	USB2_SSRX-	DIFF	
15	USB2_SSRX+	DIFF	
16	GND	GND	
17	USB2_SSTX-	DIFF	
18	USB2_SSTX+	DIFF	

2.4.11 Dual USB 2.0 Port (CN12/CN13)

Standard specification.

2.4.12 COM 2 Wafer (Optional) (CN14)

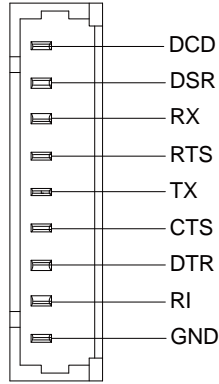

Pin	RS-232	RS-422	RS-485	Signal Type
1	DCD	RS422_TX-	RS485_D-	IN
2	DSR			IN
3	RX	RS422_TX+	RS485_D+	OUT
4	RTS			OUT
5	TX	RS422_RX+		GND
6	CTS			IN
7	DTR	RS422_RX-		OUT
8	RI			IN
9	GND			IN

2.4.13 COM 1 Wafer (Optional) (CN16)

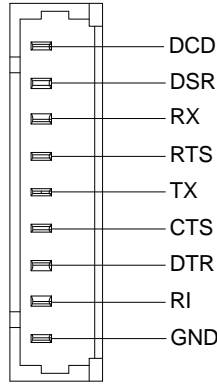

Pin	RS-232	RS-422	RS-485	Signal Type
1	DCD		RS485_D-	IN
2	DSR			IN
3	RX	RS422_TX+	RS485_D+	OUT
4	RTS			OUT
5	TX	RS422_RX+		GND
6	CTS			IN
7	DTR	RS422_RX-		OUT
8	RI			IN
9	GND			IN

2.4.14 COM 3 Wafer (Optional) (CN17)

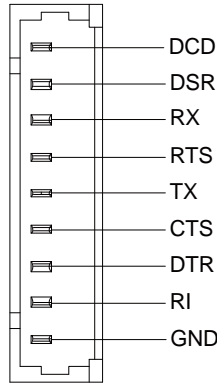

Pin	RS-232	RS-422	RS-485	Signal Type
1	DCD		RS485_D-	IN
2	DSR			IN
3	RX	RS422_TX+	RS485_D+	OUT
4	RTS			OUT
5	TX	RS422_RX+		GND
6	CTS			IN
7	DTR	RS422_RX-		OUT
8	RI			IN
9	GND			IN

2.4.15 COM 4 Wafer (Optional) (CN18)

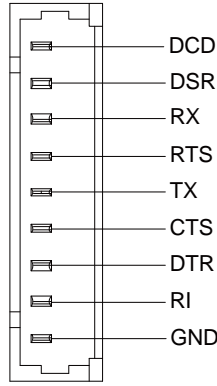

Pin	RS-232	RS-422	RS-485	Signal Type
1	DCD		RS485_D-	IN
2	DSR			IN
3	RX	RS422_TX+	RS485_D+	OUT
4	RTS			OUT
5	TX	RS422_RX+		GND
6	CTS			IN
7	DTR	RS422_RX-		OUT
8	RI			IN
9	GND			IN

2.4.16 Dual DB-9 Port (COM 1 + COM 2) (CN15)

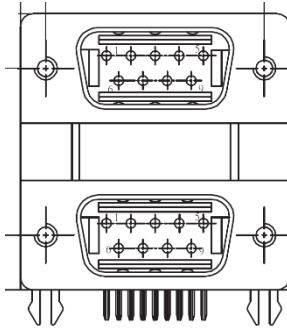

Pin	RS-232	RS-422	RS-485	Signal Type
1	DCD	RS422_TX-	RS485_D-	IN
2	RX	RS422_TX+	RS485_D+	IN
3	TX	RS422_RX+		OUT
4	DTR	RS422_RX-		OUT
5	GND			GND
6	DSR			IN
7	RTS			OUT
8	CTS			IN
9	RI			IN

2.4.17 Dual DB-9 Port (COM 3 + COM 4) (CN19)

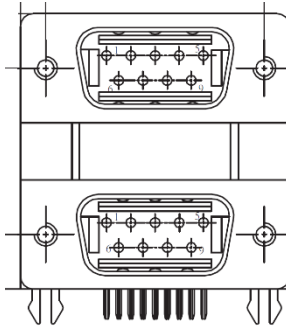

Pin	RS-232	RS-422	RS-485	Signal Type
1	DCD	RS422_TX-	RS485_D-	IN
2	RX	RS422_TX+	RS485_D+	IN
3	TX	RS422_RX+		OUT
4	DTR	RS422_RX-		OUT
5	GND			GND
6	DSR			IN
7	RTS			OUT
8	CTS			IN
9	RI			IN

2.4.18 Dual DB-9 Port (COM 5 + COM 6) (CN20)

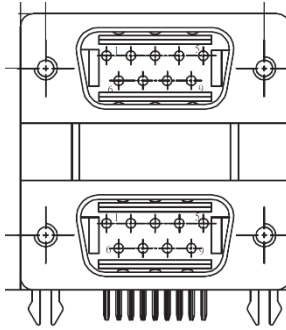

Pin	RS-232	RS-422	RS-485	Signal Type
1	DCD	RS422_TX-	RS485_D-	IN
2	RX	RS422_TX+	RS485_D+	IN
3	TX	RS422_RX+		OUT
4	DTR	RS422_RX-		OUT
5	GND			GND
6	DSR			IN
7	RTS			OUT
8	CTS			IN
9	RI			IN

2.4.19 SPI Flash Wafer (CN21)

Pin	Signal	Signal Type	Signal Level
1	SPI_MISO	OUT	
2	GND	GND	
3	SPI_CLK	IN	
4	+3.3VSB	PWR	+3.3V
5	SPI_MOSI	IN	

Pin	Signal	Signal Type	Signal Level
6	SPI_CS	IN	
7	NC		
8	NC		

2.4.20 eSPI Wafer (CN22)

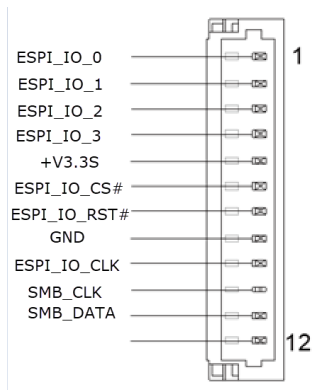

Pin	Signal	Signal Type	Signal Level
1	ESPI_IO_0	I/O	+1.8V
2	ESPI_IO_1	I/O	+1.8V
3	ESPI_IO_2	I/O	+1.8V
4	ESPI_IO_3	I/O	+1.8V
5	+3.3V	PWR	+3.3V
6	ESPI_IO_CS#	IN	
7	ESPI_IO_RST#	IN	
8	GND	GND	
9	ESPI_IO_LCLK	IN	
10	SMCLK	IN	
11	SMDAT	I/O	
12	NC		

2.4.21 SATA Connector (CN23)

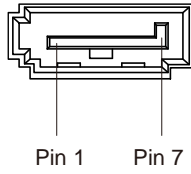

Pin	Signal	Signal Type	Signal Level
1	GND	GND	
2	SATA_TX+	DIFF	
3	SATA_TX-	DIFF	
4	GND	GND	
5	SATA_RX-	DIFF	
6	SATA_RX+	DIFF	
7	GND	GND	

2.4.22 SATA Power (CN24)



Pin	Signal
1	+5V
2	GND

2.4.23 DIO Wafer (CN25)

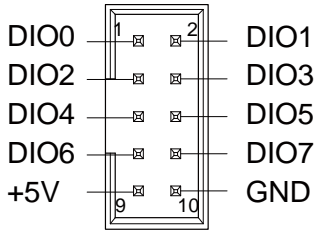

Pin	Signal	Signal Type	Signal Level
1	DIO0	I/O	+5V
2	DIO1	I/O	+5V
3	DIO2	I/O	+5V
4	DIO3	I/O	+5V
5	DIO4	I/O	+5V
6	DIO5	I/O	+5V
7	DIO6	I/O	+5V
8	DIO7	I/O	+5V
9	+5V	PWR	+5V
10	GND	GND	

2.4.24 DB-15 Port (DIO) (CN26)

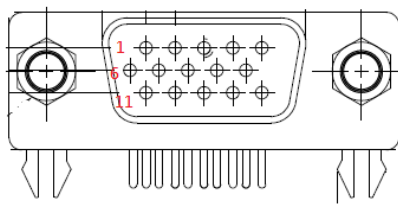

Pin	Signal	Signal Type	Signal Level
1	DIO0	I/O	+5V
2	DIO1	I/O	+5V

Pin	Signal	Signal Type	Signal Level
2P	HP_DET_3	IN	
2Q	HP_DET_4	IN	
14	MIC_L	IN	
11	MIC_R	IN	
1P	HP_DET_1	IN	
1Q	HP_DET2	IN	

2.4.26 Terminal 3-Pin Power Input (CN29)

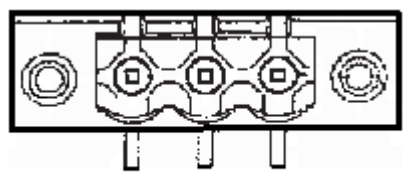

PIN1 PIN2 PIN3

Pin	Signal	Signal Type	Signal Level
1	VIN	PWR	+12V ~ +24V
2	GND	GND	
3	GND_EARTH		

2.5 Memory RAM Module Installation

Before installing the RAM, ensure the system is powered down and disconnect the power cord from the system. Make sure you have the RAM module ready to install. See Chapter 1 for RAM requirements and specifications.

Step 1: Remove the six (6) screws from the bottom of the BOXER-6617-ADN as shown in the figure below. Remove the bottom panel from the system. Note the placement of the RAM and expansion module slots.

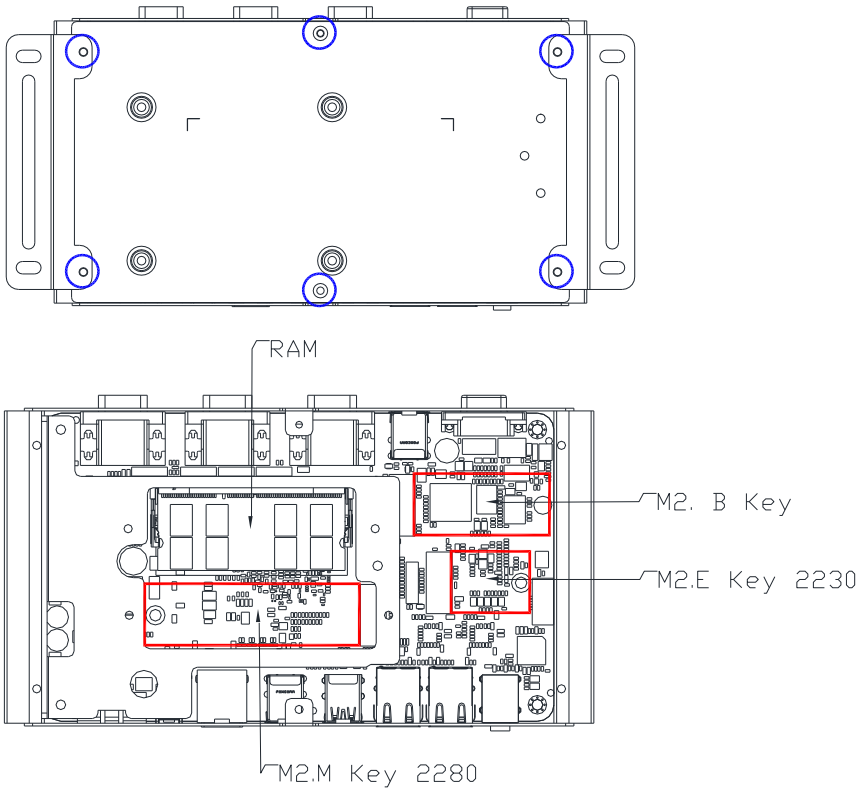

Step 2: Place thermal pads on the RAM modules and insert them into the RAM slots.

Note the figure below for placement of thermal pads. When inserting the modules into the RAM slots, first insert at an angle (~30°), then gently push down until secure.

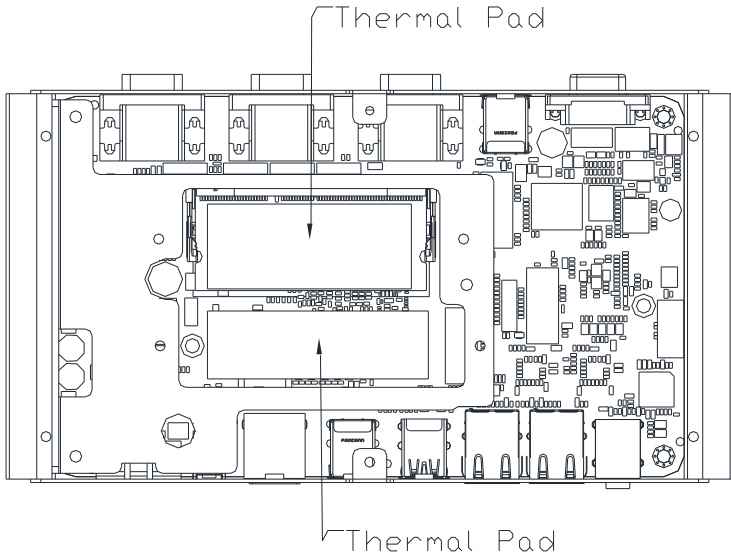

Step 3: Install the RAM bracket. Ensure it is oriented as shown in the figure below.

Attach the bracket to the chassis using four (4) screws, as shown..

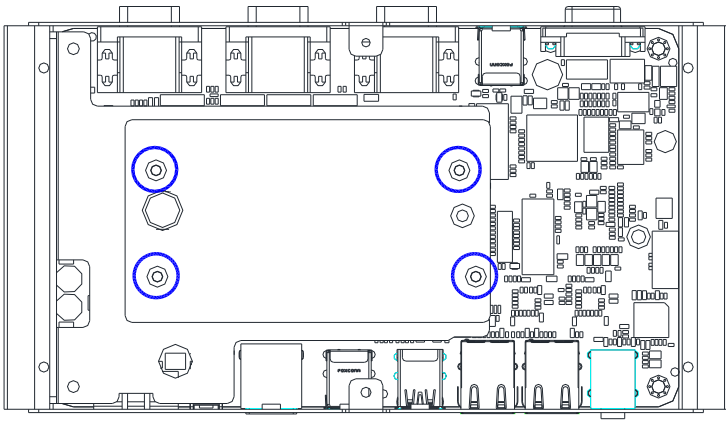

RAM installation is complete. If you also need to install the 2.5" SATA Drive, continue to the next section. If you are done, replace the bottom panel and secure with the six (6) screws you removed in Step 1 of this section.

2.6 2.5" SATA Drive Installation

Before installing the SATA Drive, ensure the system is powered down and disconnect the power cord from the system. Make sure you have the SATA Drive ready to install. See Chapter 1 for SATA drive specifications for compatibility.

Step 1: If you have not already done so, remove the six (6) screws from the bottom of the BOXER-6617-ADN as shown in the figure below. Remove the bottom panel from the system.

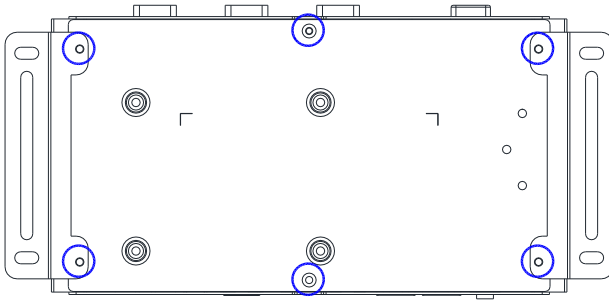

Step 2: Attach the SATA drive to the HDD Bracket using the screws provided.

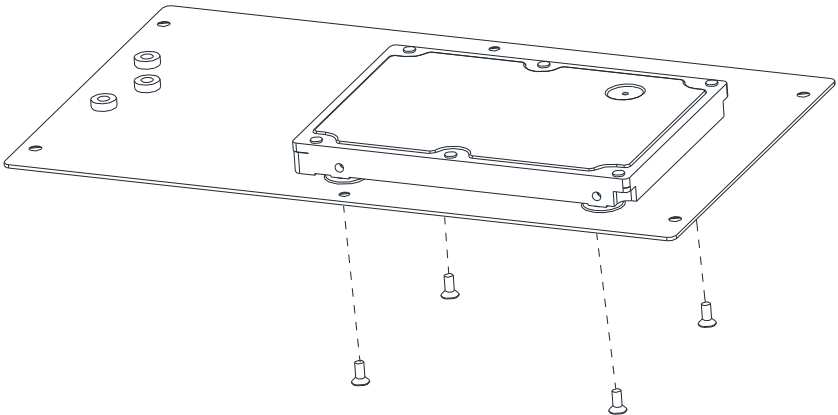

Step 3: Attach the HDD Bracket to the bottom panel using four screws as shown in the figure below. Attach the SATA and SATA Power cables to the board and the SATA drive.

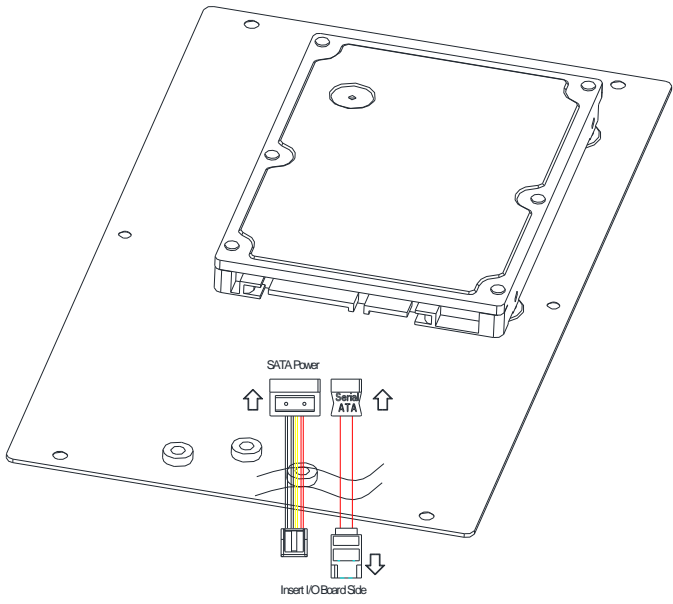

Step 4: Replace the bottom panel and secure with the six (6) screws you removed in Step 1.

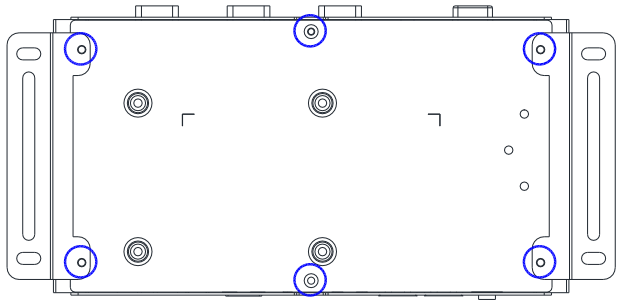

2.7 DIN Rail Installation

Affix the DIN Rail bracket to the underside of the chassis using the three (3) screws provided, as shown below.

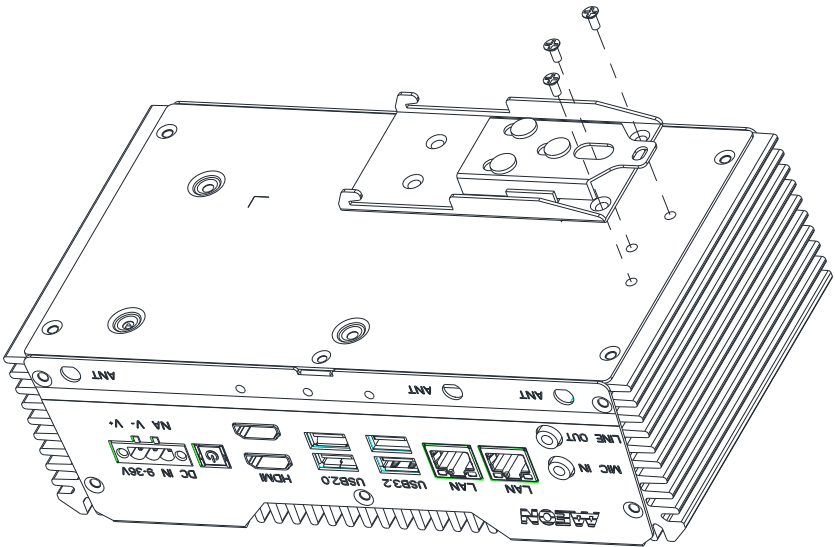

Chapter 3

AMI BIOS Setup

3.1 System Test and Initialization

The system uses certain routines to perform testing and initialization during the boot up sequence. If an error, fatal or non-fatal, is encountered, the system will output a few short beeps or an error message. The board can usually continue the boot up sequence with non-fatal errors.

The system configuration verification routines check the current system configuration against the values stored in the CMOS memory. If they do not match, an error message will be output, and the BIOS setup program will need to be run to set the configuration information in memory.

There are three situations in which the CMOS settings will need to be set or changed:

- Starting the system for the first time
- The system hardware has been changed
- The CMOS memory has lost power and the configuration information is erased

The system's CMOS memory uses a backup battery for data retention. The battery must be replaced when it runs down.

3.2 AMI BIOS Setup

The AMI BIOS ROM has a pre-installed Setup program that allows users to modify basic system configurations, which is stored in the battery-backed CMOS RAM and BIOS NVRAM so that the information is retained when the power is turned off.

To enter BIOS Setup, press or <F2> immediately while your computer is powering up.

The function for each interface can be found below.

Main – Date and time can be set here. Press <Tab> to switch between date elements

Advanced – Enable/ Disable boot option for legacy network devices

System I/O – Enable/ Disable system I/O device

Security – The setup administrator password can be set here

Boot – Enable/ Disable Quiet Boot option

Save & Exit – Save your changes and exit the program

3.3 Setup Submenu: Main



3.4 Setup Submenu: Advanced



3.4.1 CPU Configuration

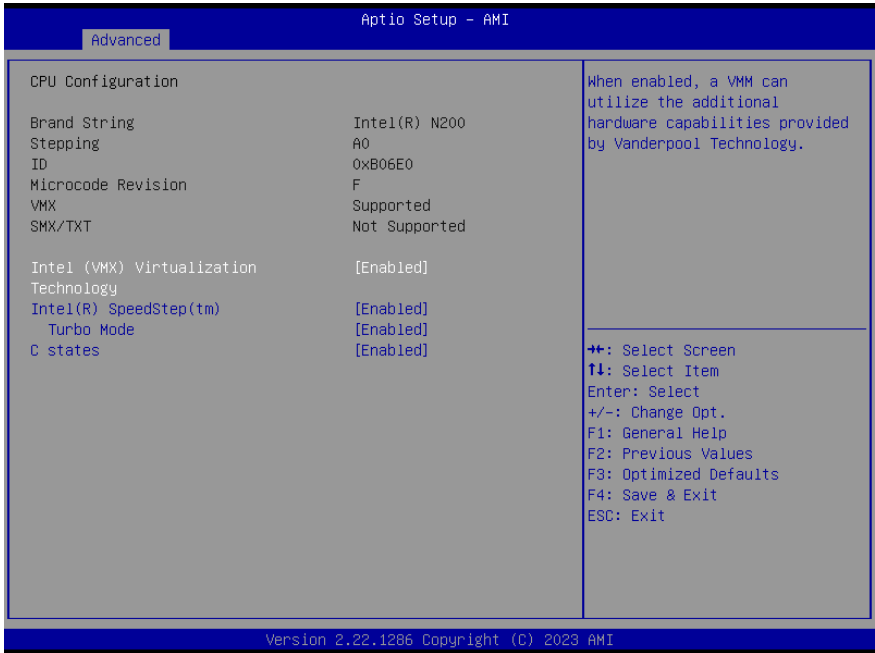

Options Summary		
Intel (VMX) Virtualization Technology	Disabled	
	Enabled	Optimal Default, Failsafe Default
When enabled, a VMM can utilize the additional hardware capabilities provided by Vanderpool Technology.		
Intel(R) SpeedStep(tm)	Disabled	
	Enabled	Optimal Default, Failsafe Default
Allows more than two frequency ranges to be supported.		
Turbo Mode	Disabled	
	Enabled	Optimal Default, Failsafe Default
Enabled/Disable processor Turbo Mode (requires EMTTM enabled too). AUTO means enabled.		
C states	Disabled	
	Enabled	Optimal Default, Failsafe Default
Enabled/Disable CPU Power Management. Allows CPU to go to C states when it's not 100% utilized		

3.4.2 Memory Configuration

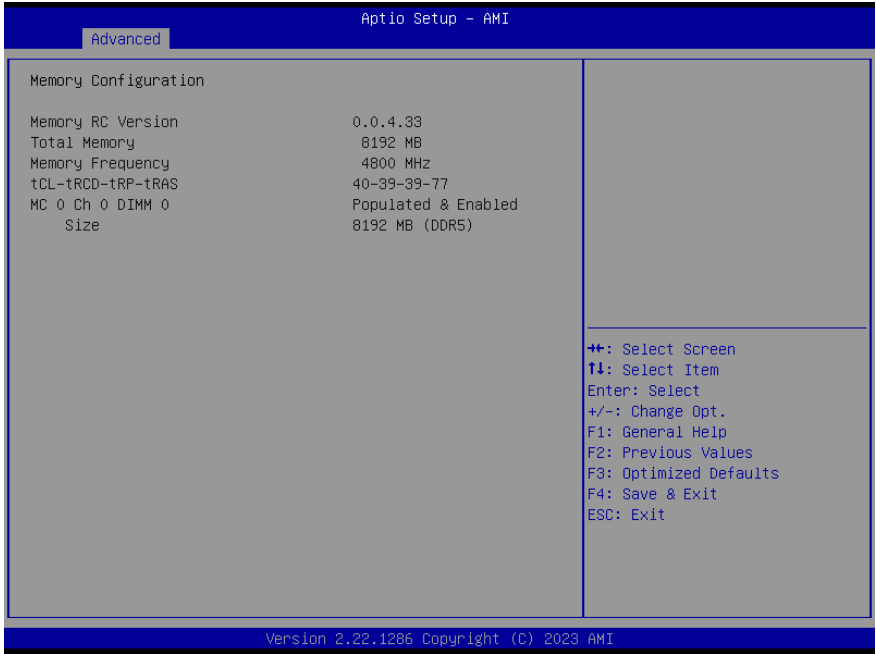

3.4.3 PCH-FW Configuration

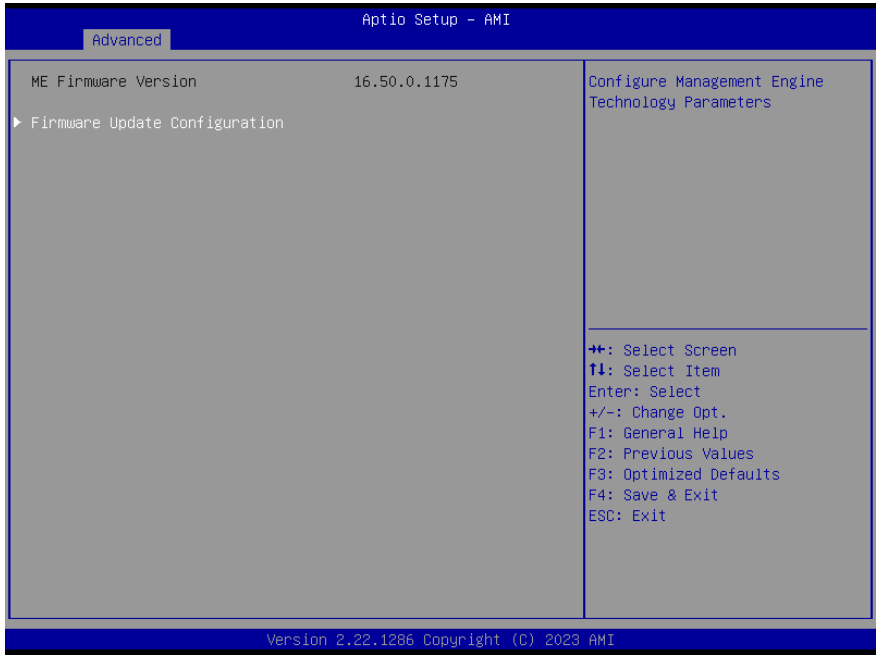

3.4.3.1 Firmware Update Configuration

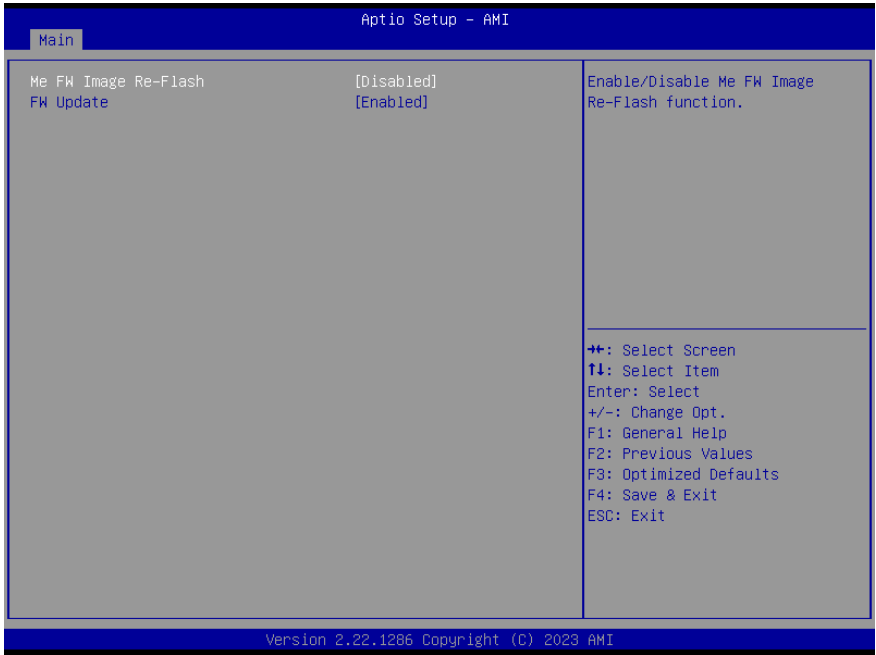

Options Summary		
ME FW Image Re-Flash	Enabled	
	Disabled	Optimal Default, Failsafe Default
Enable/Disable ME FW Image Re-Flash function.		
FW Update	Enabled	
	Disabled	Optimal Default, Failsafe Default
Enabled/Disable Me FW Update function.		

3.4.4 Hardware Monitor

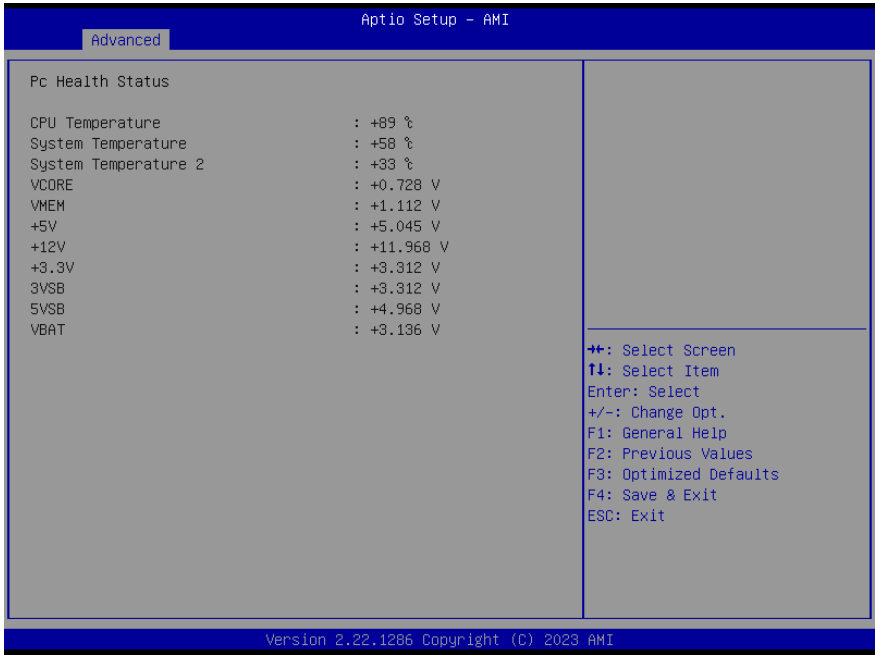

3.4.5 Power Management

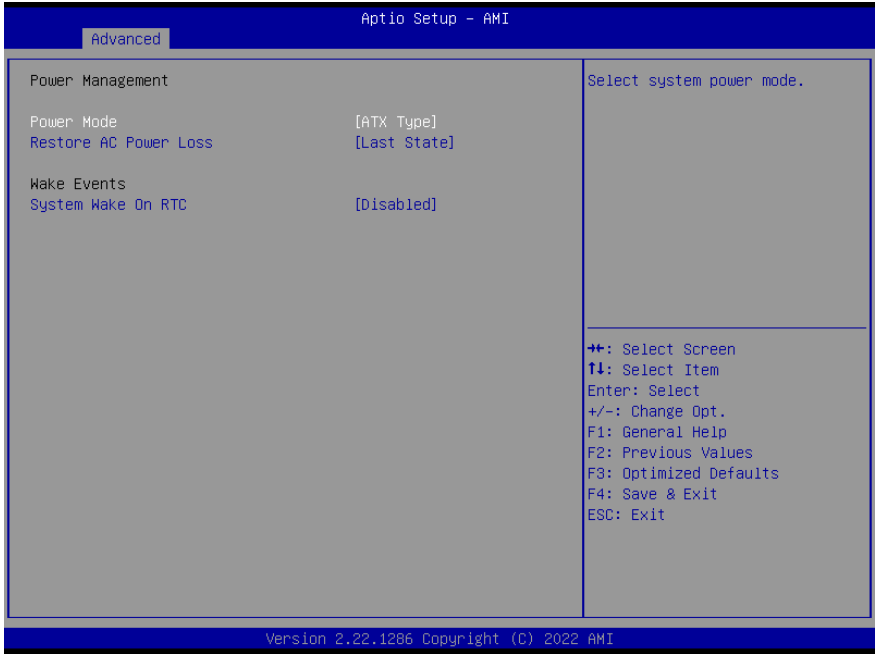

Options Summary		
Power Mode	ATX Type	Optimal Default, Failsafe Default
	AT Type	
Select system power mode		
Restore AC Power Loss	Last State	Optimal Default, Failsafe Default
	Always On	
	Always Off	
System Wake On RTC		
System Wake On RTC	Disabled	Optimal Default, Failsafe Default
	By Date	
	By Weekday	
	Bypass	
<p>By Date: System will wake on the day with hr::min::sec specified.</p> <p>By Weekday: System will wake on the enabled weekday with hr::min::sec specified.</p> <p>Bypass: BIOS will not control RTC wake function.</p>		

3.4.6 AAEON BIOS Robot



Options Summary		
Sends watch dog before BIOS POST	Disabled	Optimal Default, Failsafe Default
	Enabled	
Enabled – Robot set Watch Dog Timer (WDT) right after power on, before BIOS start POST process. And then Robot will clear WDT on completion of POST. WDT on completion of POST. WDT. WDT will reset system automatically if it is not cleared before its timer counts down to zero.		
Sends watch dog before booting OS	Disabled	Optimal Default, Failsafe Default
	Enabled	
Enabled – Robot set Watch Dog Timer (WDT) after POST completion, before BIOS transfer control to OS. WARNING: Before enabling this function, a program in OS must be in responsible for clearing WDT. Also, this function should be disabled if OS I going to update itself.		
Delayed POST (PEI phase)	Disabled	Optimal Default, Failsafe Default
	Enabled	

Options Summary		
Enabled - Robot holds BIOS from starting POST, right after power on. This allows BIOS POST to start with stable power or start after system is physically warmed-up. Note: Robot does this before 'Sends watch dog'.		
Delayed POST (DXE phase)	Disabled	Optimal Default, Failsafe Default
	Enabled	
Enabled - Robot holds BIOS before POST completion. This allows BIOS POST to start with stable power or start after system is physically warmed-up. Note: Robot does this after 'Sends watch dog before BIOS POST'.		

3.4.6.1 Device Detecting Configuration

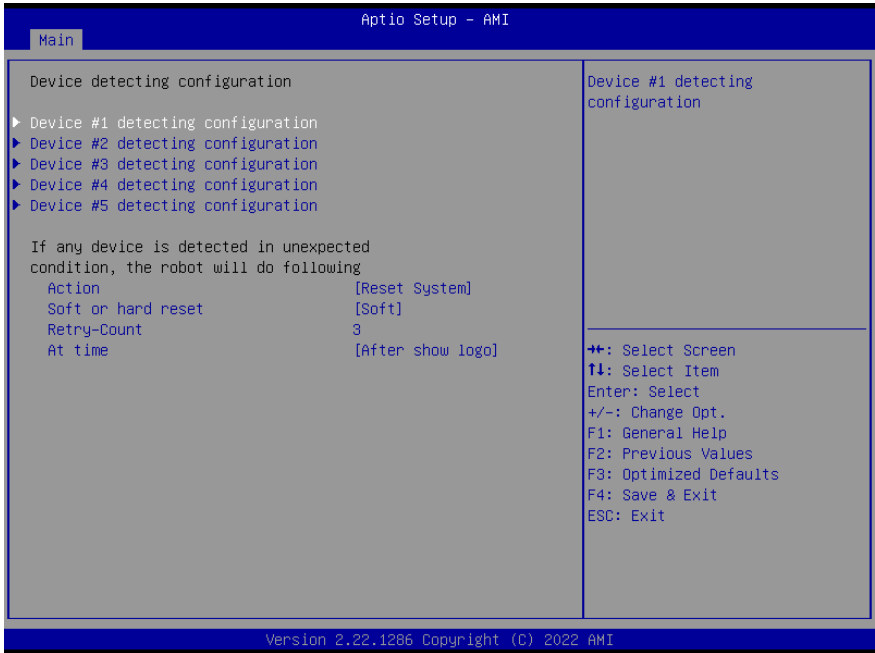

Options Summary		
Action	Reset System	Optimal Default, Failsafe Default
	Hold System	
Select action that robot should do.		
Soft or hard reset	Soft	Optimal Default, Failsafe Default
	Hard	
Select reset type robot should send on each boot.		
Retry-Count	3	Optimal Default, Failsafe Default
Fill retry counter here. Robot will reset system at most counter times, and then let system continue its POST.		
At time	After shoe logo	Optimal Default, Failsafe Default
	Before show logo	
Select robot action time: After show logo - Robot will do action after logo is displayed. System devices are almost ready. Before show logo - Robot will do action earlier before logo, but some devices may not be ready.		

3.4.6.1.1 Device #1 Detecting Configuration

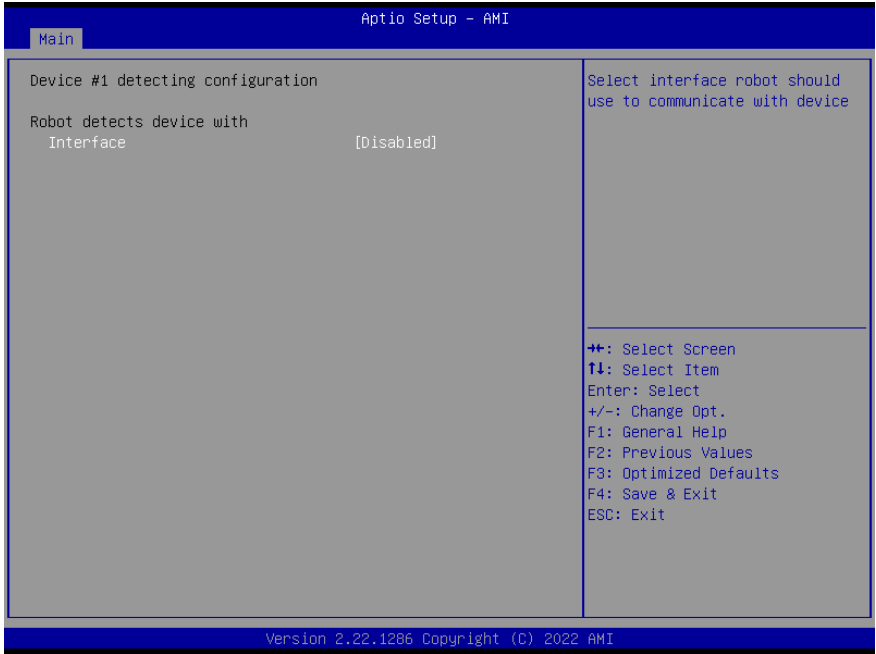

Options Summary		
Interface	Disabled	Optimal Default, Failsafe Default
	PCI	
	DIO	
	SMBUS	
	Legacy I/O	
	Super I/O	
	MMIO	
Select interface robot should use to communicate with device.		

3.4.6.1.2 Device #2 Detecting Configuration

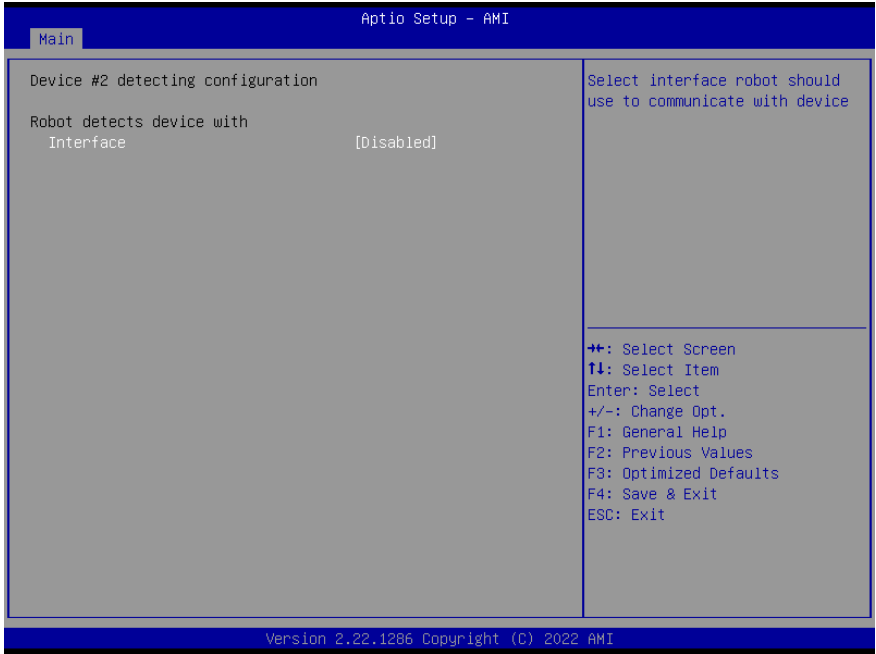

Options Summary		
Interface	Disabled	Optimal Default, Failsafe Default
	PCI	
	DIO	
	SMBUS	
	Legacy I/O	
	Super I/O	
	MMIO	
Select interface robot should use to communicate with device.		

3.4.6.1.3 Device #3 Detecting Configuration

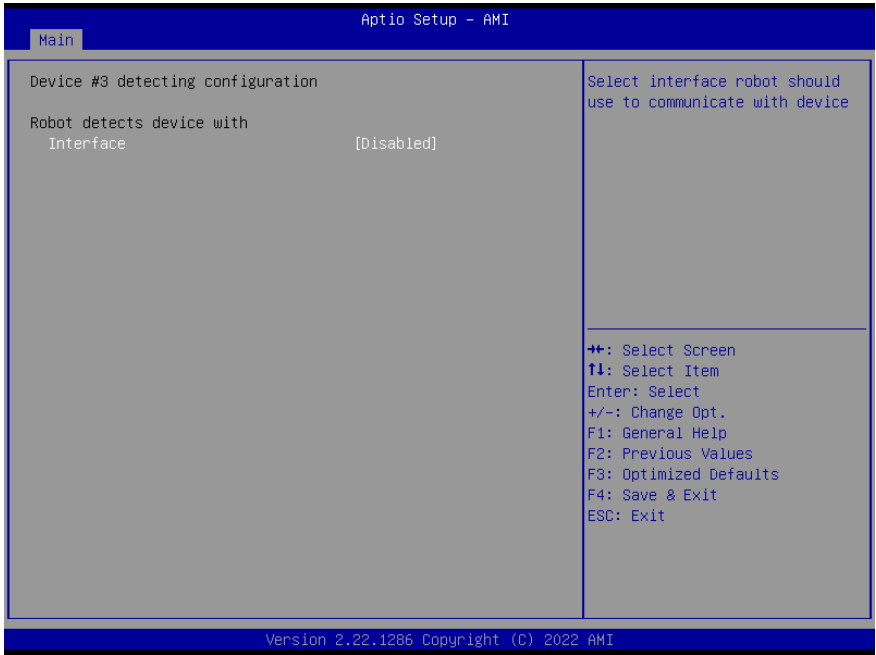

Options Summary		
Interface	Disabled	Optimal Default, Failsafe Default
	PCI	
	DIO	
	SMBUS	
	Legacy I/O	
	Super I/O	
	MMIO	
Select interface robot should use to communicate with device.		

3.4.6.1.4 Device #4 Detecting Configuration

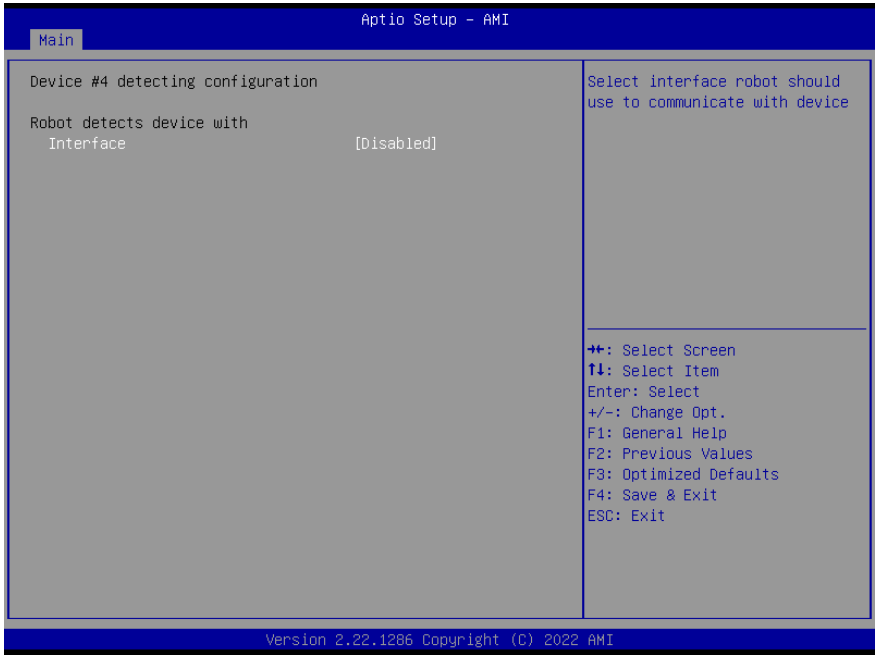

Options Summary		
Interface	Disabled	Optimal Default, Failsafe Default
	PCI	
	DIO	
	SMBUS	
	Legacy I/O	
	Super I/O	
	MMIO	
Select interface robot should use to communicate with device.		

3.4.6.1.5 Device #5 Detecting Configuration

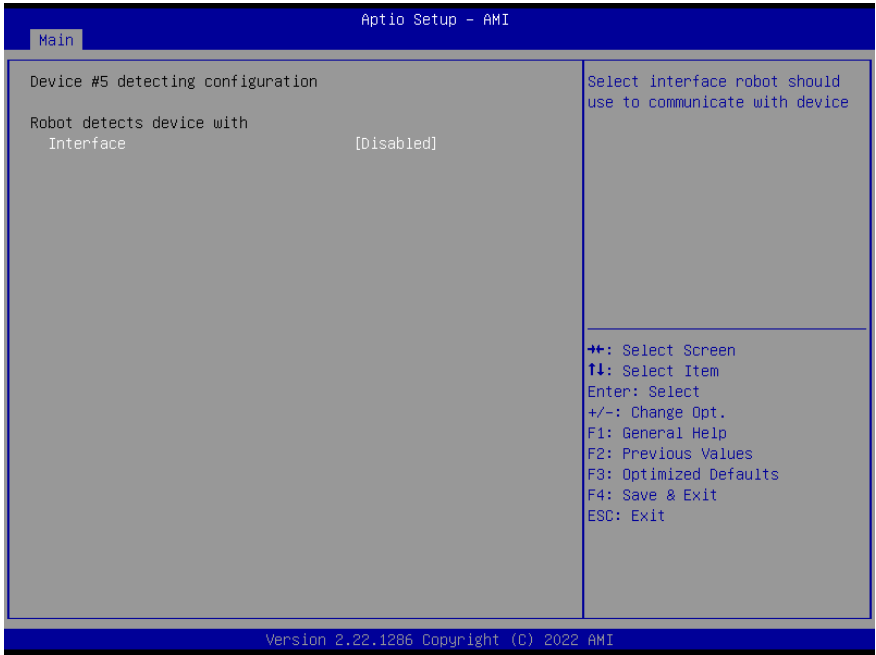

Options Summary		
Interface	Disabled	Optimal Default, Failsafe Default
	PCI	
	DIO	
	SMBUS	
	Legacy I/O	
	Super I/O	
	MMIO	
Select interface robot should use to communicate with device.		

3.5 Setup Submenu: System I/O



3.5.1 Storage Configuration

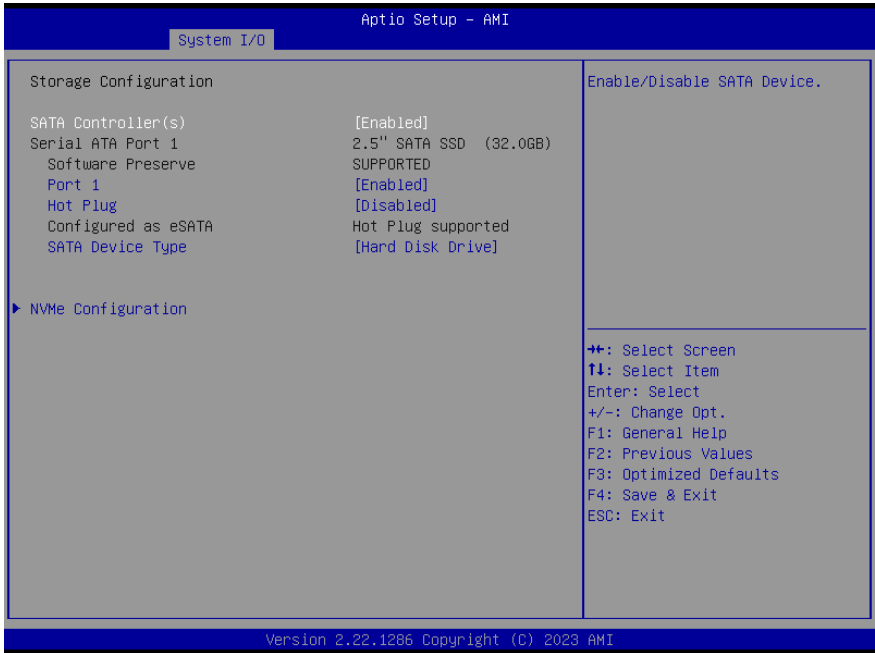

Options Summary		
SATA Controller(s)	Enabled	Optimal Default, Failsafe Default
	Disabled	
Enable/Disable to SATA Device.		
Port 1	Enabled	Optimal Default, Failsafe Default
	Disabled	
Enable/Disable to SATA Port.		
Hot Plug	Enabled	
	Disabled	Optimal Default, Failsafe Default
Designates this port as Hot Pluggable.		
SATA Device Type	Hard Disk Drive	Optimal Default, Failsafe Default
	Solid State Drive	
Identify the SATA port is connected to Solid State Drive or Hard Disk Drive.		

3.5.2 HD Audio Configuration



Options Summary		
HD Audio	Enabled	Optimal Default, Failsafe Default
	Disabled	
Control Detection of the HD-Audio device. Disabled = HDA will be unconditionally disabled. Enabled = HDA will be unconditionally enabled.		

3.5.3 Digital IO Port Configuration



Options Summary		
DIO1	Input	
	Output	Optimal Default, Failsafe Default
Set DIO as Input or Output.		
Output Level	Low	
	High	Optimal Default, Failsafe Default
Set output level when DIO pin is output.		
DIO2	Input	
	Output	Optimal Default, Failsafe Default
Set DIO as Input or Output.		
Output Level	Low	
	High	Optimal Default, Failsafe Default
Set output level when DIO pin is output.		
DIO3	Input	
	Output	Optimal Default, Failsafe Default
Set DIO as Input or Output.		

Options Summary		
Output Level	Low	
	High	Optimal Default, Failsafe Default
Set output level when DIO pin is output.		
DIO4	Input	
	Output	Optimal Default, Failsafe Default
Set DIO as Input or Output.		
Output Level	Low	
	High	Optimal Default, Failsafe Default
Set output level when DIO pin is output.		
DIO5	Input	Optimal Default, Failsafe Default
	Output	
Set DIO as Input or Output.		
DIO6	Input	Optimal Default, Failsafe Default
	Output	
Set DIO as Input or Output.		
DIO7	Input	Optimal Default, Failsafe Default
	Output	
Set DIO as Input or Output.		
DIO8	Input	Optimal Default, Failsafe Default
	Output	
Set DIO as Input or Output.		

3.5.4 Legacy Logical Devices Configuration

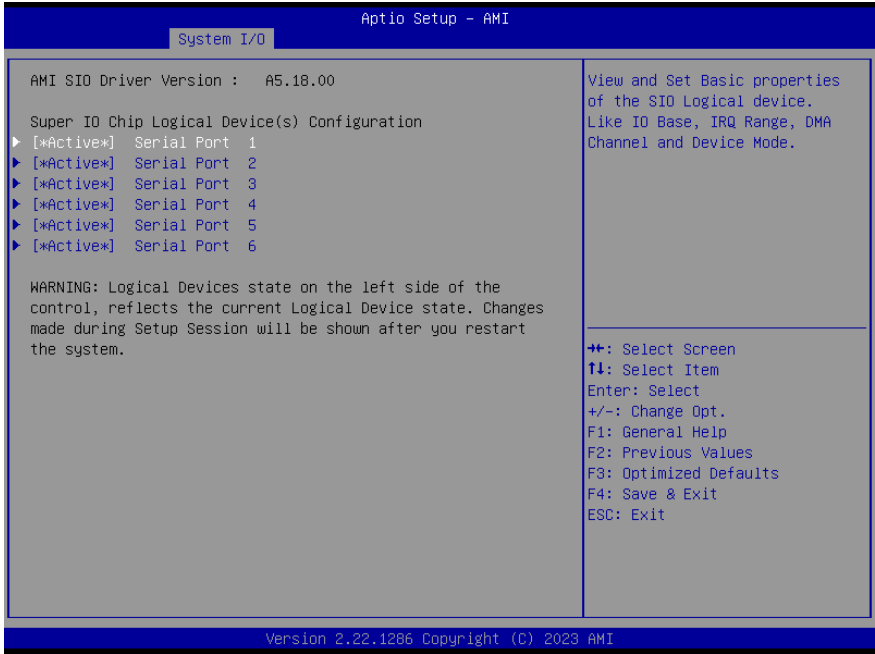

3.5.4.1 Serial Port 1

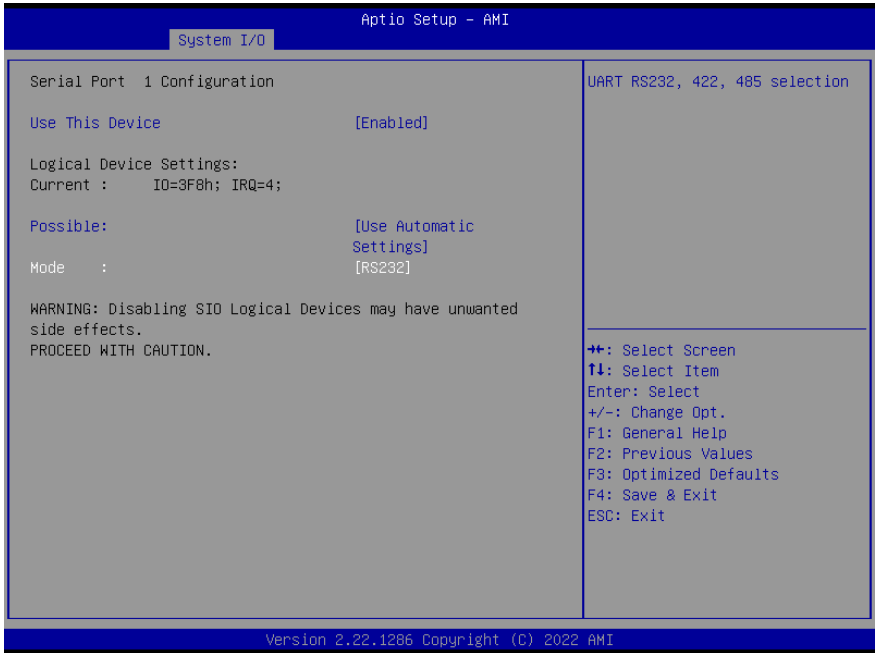

Options Summary		
Use This Device	Disabled	
	Enabled	Optimal Default, Failsafe Default
Enable or Disable this Logical Device.		
Possible:	Use Automatic Settings	Optimal Default, Failsafe Default
	IO=3F8; IRQ=4;	
	IO=2F8; IRQ=3;	
Allows the user to change the device resource settings. New settings will be reflected on this setup page after system restarts.		
Mode	RS232	Optimal Default, Failsafe Default
	RS422	
	RS485	
UART RS232, 422, 485, selection.		

3.5.4.2 Serial Port 2

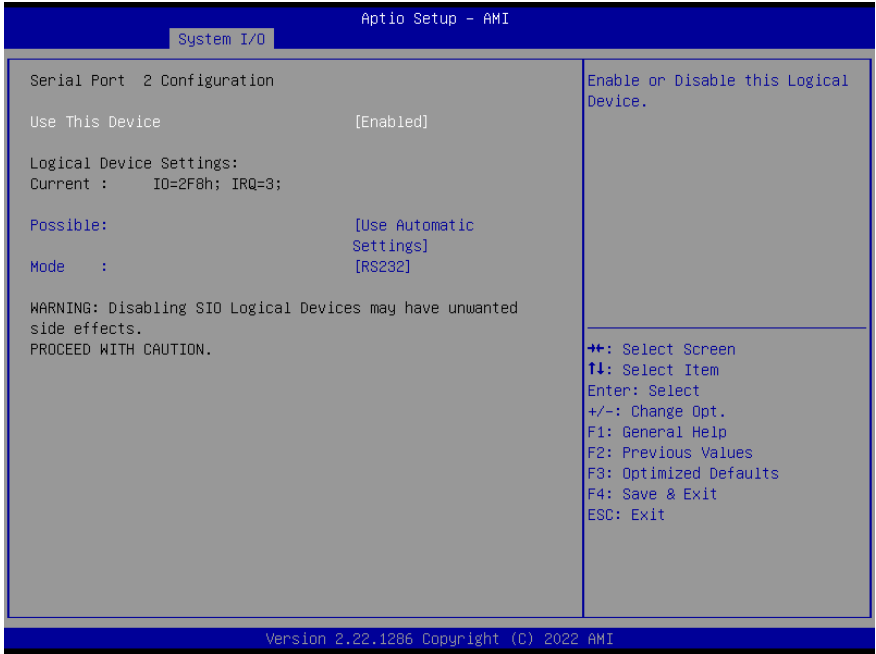

Options Summary		
Use This Device	Disabled	
	Enabled	Optimal Default, Failsafe Default
Enable or Disable this Logical Device.		
Possible:	Use Automatic Settings	Optimal Default, Failsafe Default
	IO=2F8; IRQ=3;	
	IO=3F8; IRQ=4;	
Allows the user to change the device resource settings. New settings will be reflected on this setup page after system restarts.		
Mode	RS232	Optimal Default, Failsafe Default
	RS422	
	RS485	
UART RS232, 422, 485, selection.		

3.5.4.3 Serial Port 3

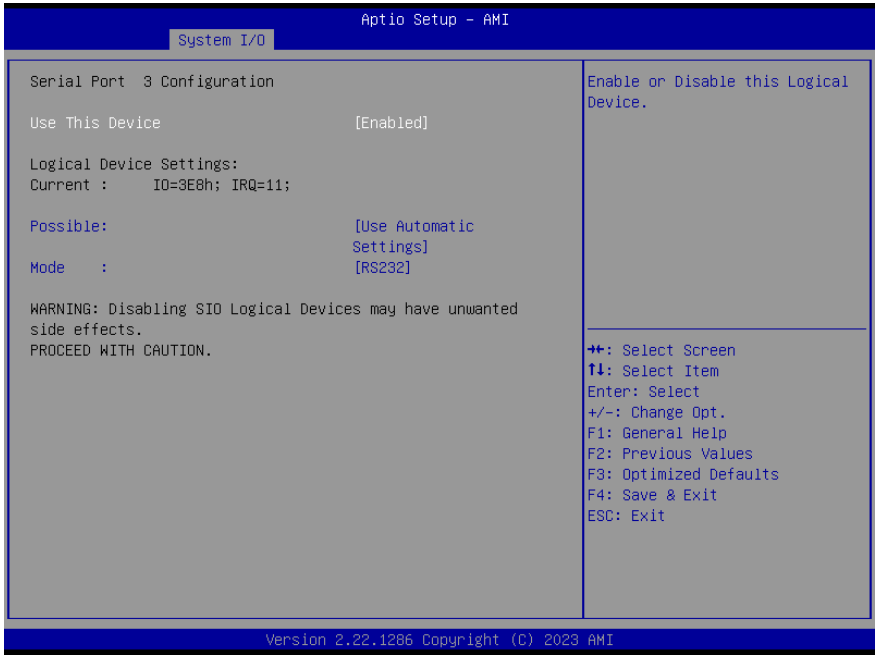

Options Summary		
Use This Device	Disabled	
	Enabled	Optimal Default, Failsafe Default
Enable or Disable this Logical Device.		
Possible:	Use Automatic Settings	Optimal Default, Failsafe Default
	IO=3E8; IRQ=11;	
	IO=2E8; IRQ=11;	
Allows the user to change the device resource settings. New settings will be reflected on this setup page after system restarts.		
Mode	RS232	Optimal Default, Failsafe Default
	RS422	
	RS485	
UART RS232, 422, 485, selection.		

3.5.4.4 Serial Port 4

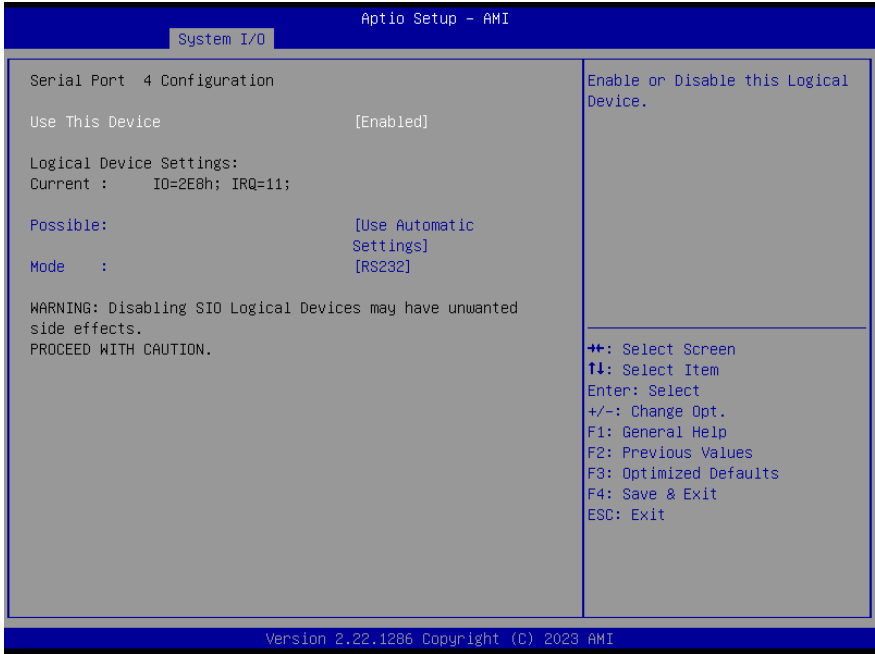

Options Summary		
Use This Device	Disabled	
	Enabled	Optimal Default, Failsafe Default
Enable or Disable this Logical Device.		
Possible:	Use Automatic Settings	Optimal Default, Failsafe Default
	IO=2E8; IRQ=11;	
	IO=3E8; IRQ=11;	
Allows the user to change the device resource settings. New settings will be reflected on this setup page after system restarts.		
Mode	RS232	Optimal Default, Failsafe Default
	RS422	
	RS485	
UART RS232, 422, 485, selection.		

3.5.4.5 Serial Port 5

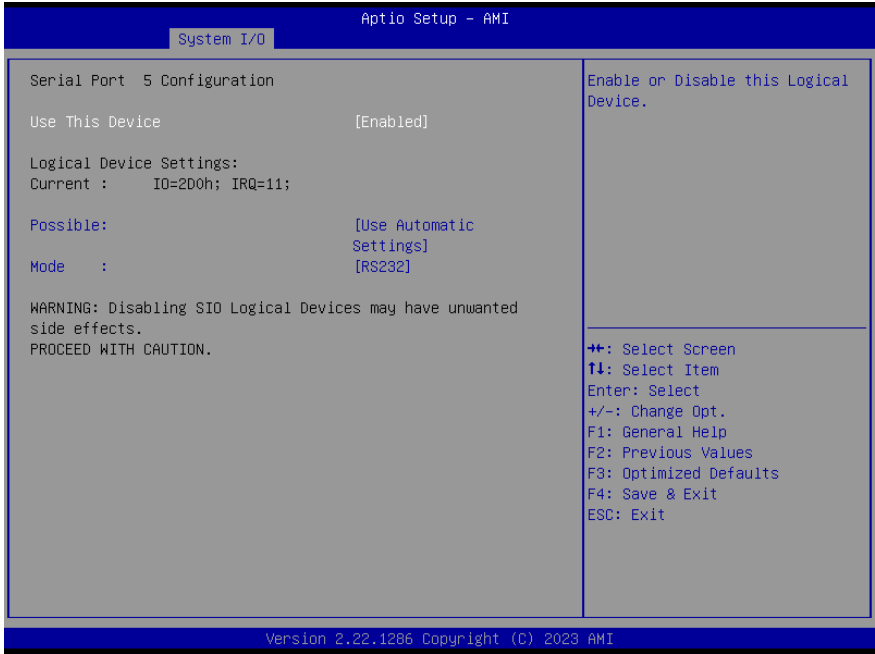

Options Summary		
Use This Device	Disabled	
	Enabled	Optimal Default, Failsafe Default
Enable or Disable this Logical Device.		
Possible:	Use Automatic Settings	Optimal Default, Failsafe Default
	IO=2D0; IRQ=11;	
	IO=2C0; IRQ=11;	
Allows the user to change the device resource settings. New settings will be reflected on this setup page after system restarts.		
Mode	RS232	Optimal Default, Failsafe Default
	RS422	
	RS485	
UART RS232, 422, 485, selection.		

3.5.4.6 Serial Port 6

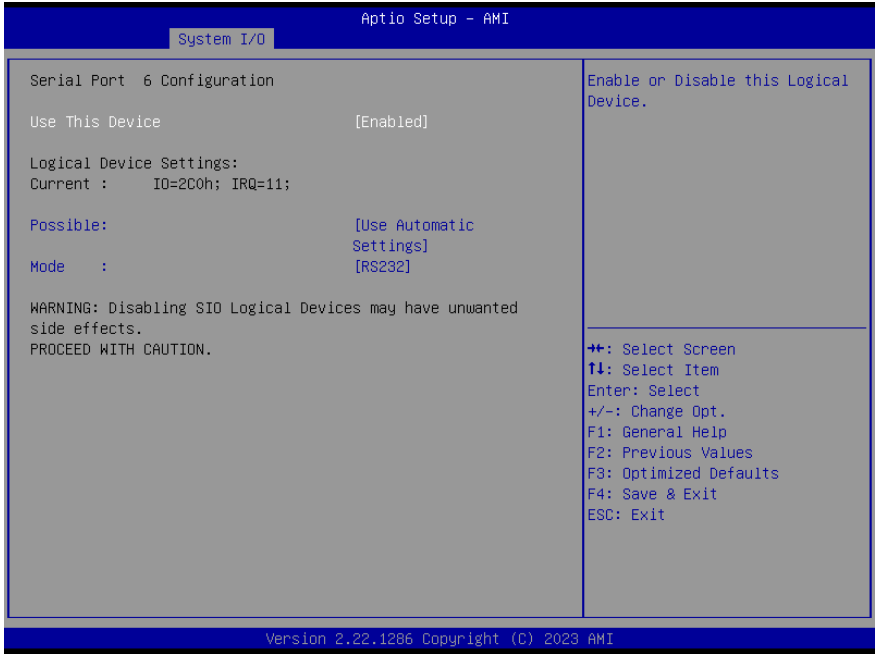

Options Summary		
Use This Device	Disabled	
	Enabled	Optimal Default, Failsafe Default
Enable or Disable this Logical Device.		
Possible:	Use Automatic Settings	Optimal Default, Failsafe Default
	IO=2C0; IRQ=11;	
	IO=2D0; IRQ=11;	
Allows the user to change the device resource settings. New settings will be reflected on this setup page after system restarts.		
Mode	RS232	Optimal Default, Failsafe Default
	RS422	
	RS485	
UART RS232, 422, 485, selection.		

3.5.5 Legacy Logical Devices Configuration

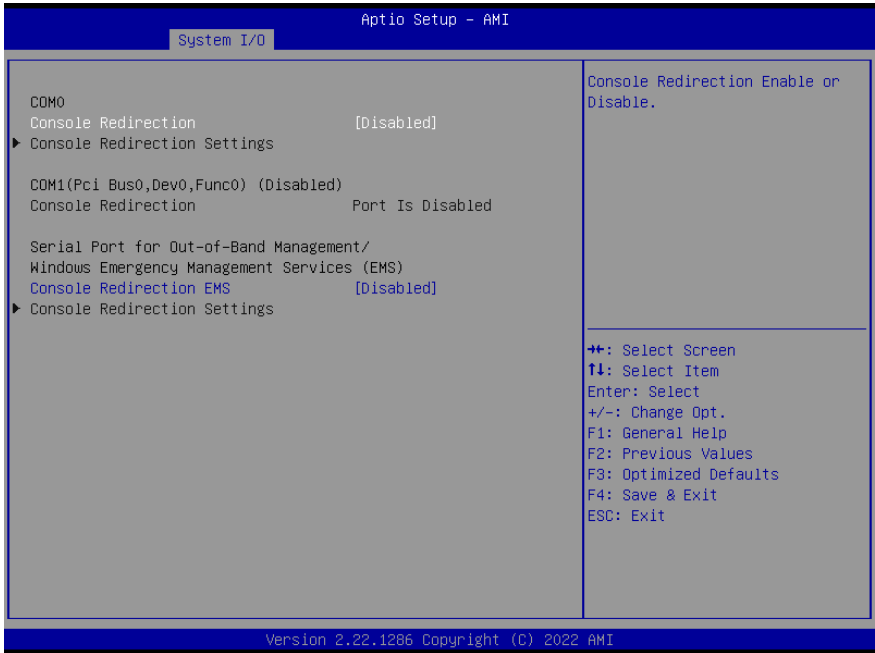

Options Summary		
Console Redirection	Disabled	Optimal Default, Failsafe Default
	Enabled	
Console Redirection Enable or Disable.		
Console Redirection EMS	Disabled	Optimal Default, Failsafe Default
	Enabled	
Console Redirection Enable or Disable.		

3.5.5.1 Console Redirection Settings (COM0)

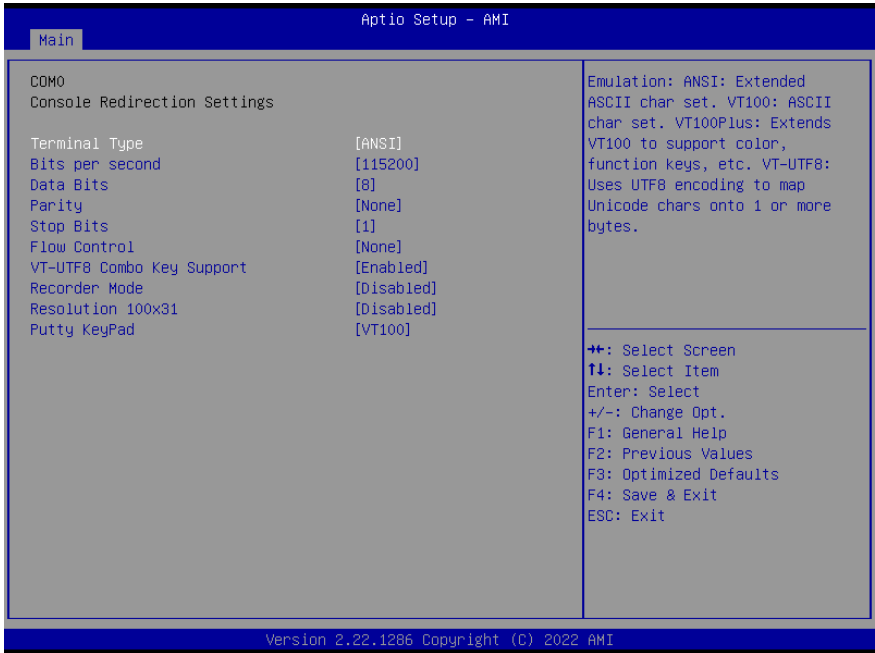

Options Summary		
Terminal Type	VT100	
	VT100Plus	
	VT-UTF8	
	ANSI	Optimal Default, Failsafe Default
<p>Emulation: ANSI: Extended ASCII char set. VT100: ASCII char set. VT100Plus: Extends VT100 to support color, function keys, etc. VT-UTF8: Uses UTF8 encoding to map Unicode chars onto 1 or more bytes.</p>		
Bits per second	9600	
	19200	
	38400	
	57600	
	115200	Optimal Default, Failsafe Default
<p>Selects serial port transmission speed. The speed must be matched on the other side. Long or noisy lines may require lower speeds.</p>		

Options Summary		
Data Bits	7	
	8	Optimal Default, Failsafe Default
Data Bits.		
Parity	None	Optimal Default, Failsafe Default
	Even	
	Odd	
	Mark	
	Space	
<p>A parity bit can be sent with the data bits to detect some transmission errors.</p> <p>Even: parity bit is 0 if the num of 1's in the data bits is even. Odd: parity bit is 0 if num of 1's in the data bits is odd. Mark: parity bit is always 1.</p> <p>Space: Parity bit is always 0. Mark and Space Parity: do not allow for error detection. They can be used as an additional data bit.</p>		
Stop Bits	1	Optimal Default, Failsafe Default
	2	
<p>Stop bits indicate the end of a serial data packet. (A start bit indicates the beginning). The standard setting is 1 stop bit. Communication with slow devices may require more than 1 stop bit.</p>		
Flow Control	None	Optimal Default, Failsafe Default
	Hardware RTS/CTS	
<p>Flow control can prevent data loss from buffer overflow.</p> <p>When sending data, if the receiving buffers are full, a 'stop' signal can be sent to stop the data flow. Once the buffers are empty, a 'start' signal can be sent to re-start the flow. Hardware flow control uses two wires to send start/stop signals.</p>		
VT-UTF8 Combo Key Support	Disabled	
	Enabled	Optimal Default, Failsafe Default
Enable VT-UTF8 Combination Key Support for ANSI/VT100 terminals.		
Recorder Mode	Disabled	Optimal Default, Failsafe Default
	Enabled	
With this mode enabled only text will be sent. This is to capture Terminal data.		
Resolution 100x31	Disabled	Optimal Default, Failsafe Default
	Enabled	
Enables or disables extended terminal resolution.		
Putty KeyPad	VT100	Optimal Default, Failsafe Default
	LINUX	
	XTERMR6	
	SCO	
	ESCN	
	VT400	
Select FunctionKey and KeyPad on Putty.		

3.5.5.2 Console Redirection Settings (Out-of-Band Mgmt)

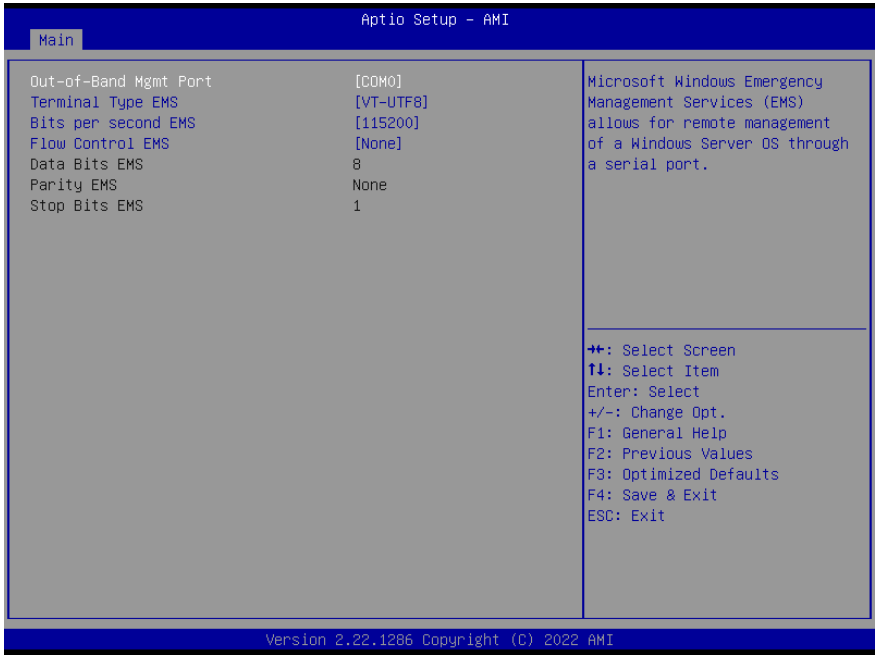

Options Summary		
Out-of-Band Mgmt Port	COM0	Optimal Default, Failsafe Default
	COM1(Pci Bus0, Dev0, Func0) (Disabled)	
Microsoft Windows Emergency Management Services (EMS) allows for remote management of a Windows Server OS through a serial port.		
Terminal Type EMS	VT100	
	VT100Plus	
	VT-UTF8	Optimal Default, Failsafe Default
	ANSI	
<p>VT-UTF8 is the preferred terminal type for out-of-band management. The next best choice is VT100+ and then VT100. See above, in Console Redirection Settings page, for more Help with Terminal Type/Emulation.</p>		

Options Summary		
Bits per second EMS	9600	
	19200	
	57600	
	115200	Optimal Default, Failsafe Default
Selects serial port transmission speed. The speed must be matched on the other side. Long or noisy lines may require lower speeds.		
Flow Control EMS	None	Optimal Default, Failsafe Default
	Hardware RTS/CTS	
	Software Xon/Xoff	
Flow control can prevent data loss from buffer overflow. When sending data, if the receiving buffers are full, a 'stop' signal can be sent to stop the data flow. Once the buffers are empty, a 'start' signal can be sent to re-start the flow. Hardware flow control uses two wires to send start/stop signals.		

3.6 Setup Submenu: Security

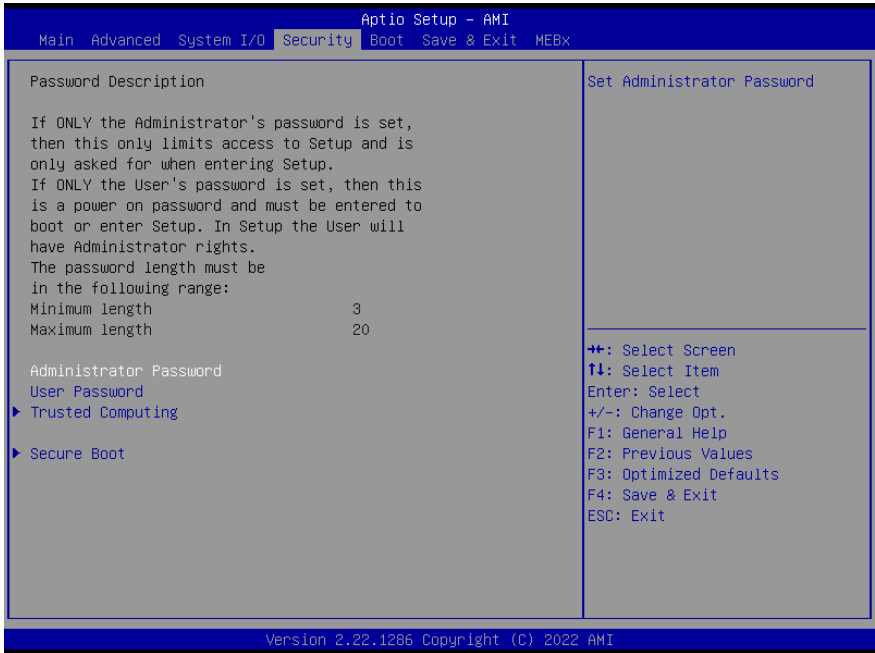

Change User/Administrator Password

You can set an Administrator Password or User Password. An Administrator Password must be set before you can set a User Password. The password will be required during boot up, or when the user enters the Setup utility. A User Password does not provide access to many of the features in the Setup utility.

Select the password you wish to set, and press Enter. In the dialog box, enter your password (must be between 3 and 20 letters or numbers). Press Enter and retype your password to confirm. Press Enter again to set the password.

Removing the Password

Select the password you want to remove and enter the current password. At the next dialog box press Enter to disable password protection.

3.6.1 Trusted Computing

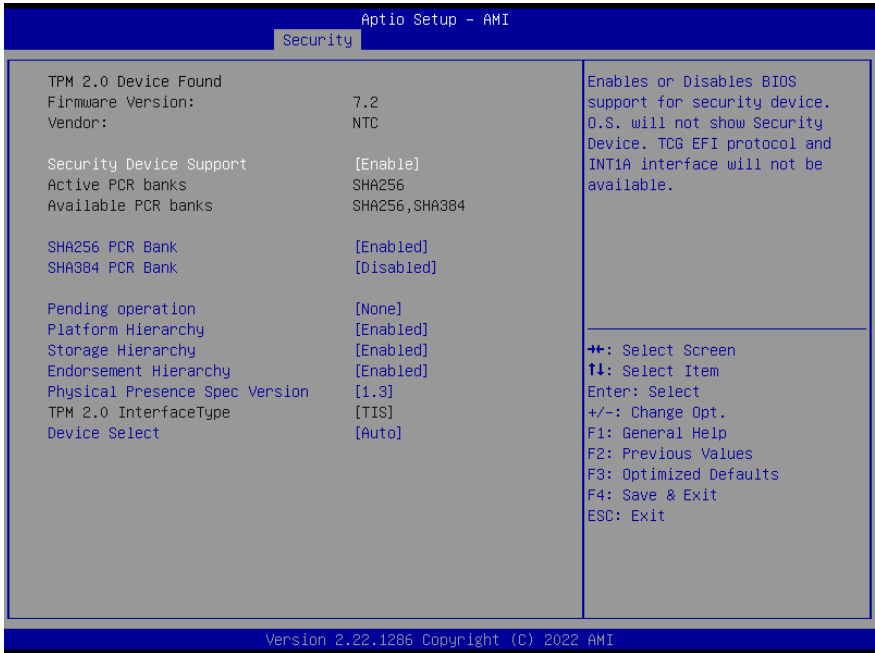

Options Summary		
Security Device Support	Enable	Optimal Default, Failsafe Default
	Disable	
Enables or Disables BIOS support for security device. O.S. will not show Security Device. TCG EFI protocol and INT1A interface will not be available.		
SHA256 PCR Bank	Disabled	Optimal Default, Failsafe Default
	Enabled	
Enable or Disable SHA256 PCR Bank.		
SHA384 PCR Bank	Disabled	Optimal Default, Failsafe Default
	Enabled	
Enable or Disable SHA384 PCR Bank.		
Pending operation	None	Optimal Default, Failsafe Default
	TPM Clear	
Schedule an Operation for the Security Device.		
NOTE: Your Computer will reboot during restart in order to change State of Security Device.		

Options Summary		
Platform Hierarchy	Disabled	
	Enabled	Optimal Default, Failsafe Default
Enable or Disable Platform Hierarchy.		
Storage Hierarchy	Disabled	
	Enabled	Optimal Default, Failsafe Default
Enable or Disable Storage Hierarchy.		
Endorsement Hierarchy	Disabled	
	Enabled	Optimal Default, Failsafe Default
Enable or Disable Endorsement Hierarchy.		
Physical Presence Spec Version	1.2	
	1.3	Optimal Default, Failsafe Default
Select to Tell O.S. to support PPI Spec Version 1.2 or 1.3. Note some HCK tests might not support 1.3.		
Device Select	TPM 1.2	
	TPM 2.0	
	Auto	Optimal Default, Failsafe Default
<p>TPM 1.2 will restrict support to TPM 1.2 devices.</p> <p>TPM 2.0 will restrict support to TPM 2.0 devices.</p> <p>Auto will support both with the default set to TPM 2.0 devices if not found.</p> <p>TPM 1.2 devices will be enumerated.</p>		

3.6.2 Secure Boot

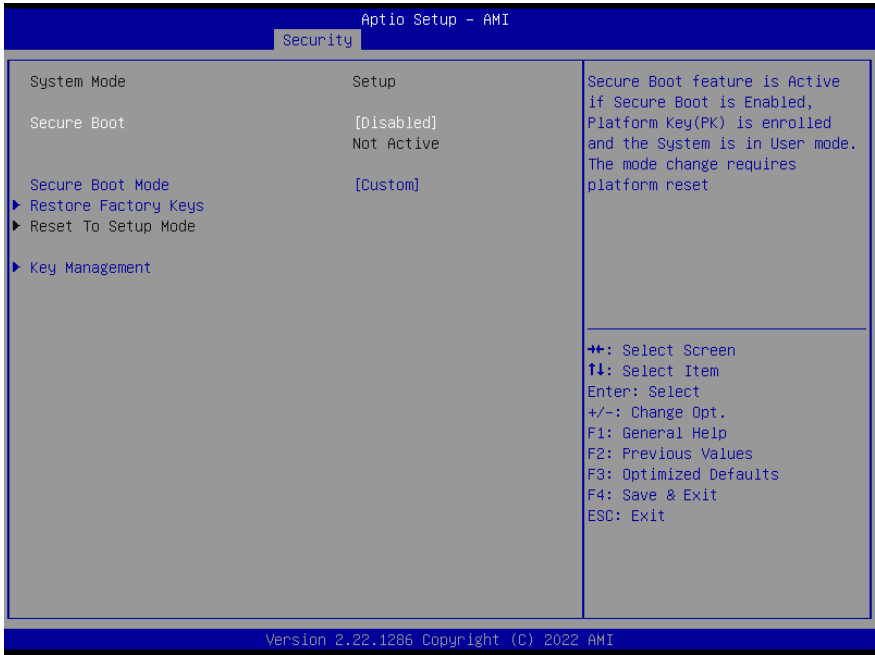

Options Summary		
Secure Boot	Disabled	Optimal Default, Failsafe Default
	Enabled	
Secure Boot feature is Active if Secure Boot is Enabled, Platform Key (PK) is enrolled and the System is in User mode. The mode change requires platform reset.		
Secure Boot Mode	Standard	Optimal Default, Failsafe Default
	Custom	
Secure Boot mode options: Standard or Custom. In Custom mode, Secure Boot Policy variables can be configured by a physically present user without full authentication.		
Restore Factory Keys	Yes	
	No	
Force System to User Mode. Install factory default Secure Boot key databases.		

3.6.2.1 Key Management

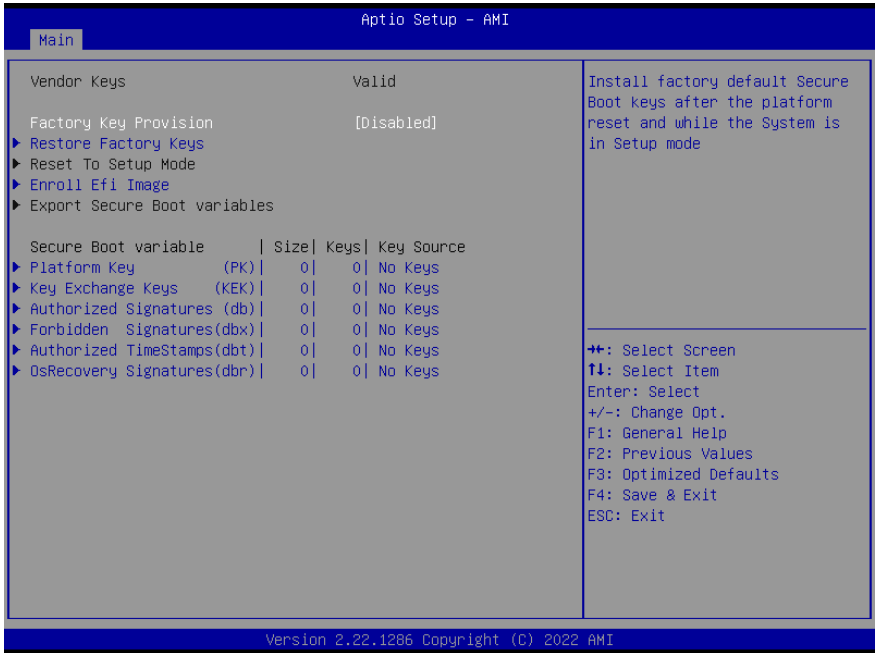

Options Summary		
Factory Key Provision	Disabled	Optimal Default, Failsafe Default
	Enabled	
Install factory default Secure Boot keys after the platform reset and while the System is in Setup mode.		
Restore Factory Keys	Yes	
	No	
Force System to User Mode. Install factory default Secure Boot key databases.		
Enroll Efi Image		
Allow Efi image to run in Secure Boot mode. Enroll SHA256 Hash certificate of a PE image into Authorized Signature Database (db).		
Platform Key (PK)	Update	
Key Exchange Keys (KEK)	Update	
	Append	
Authorized Signatures (db)	Update	
	Append	

Options Summary

Forbidden Signatures (dbx)	Update	
	Append	
Authorized TimeStamps (dbt)	Update	
	Append	
OsRecovery Signatures (dbr)	Update	
	Append	

Enroll Factory Defaults or load certificates from a file:

1. Public Key Certificate:
 - a) EFI_SIGNATURE_LIST
 - b) EFI_CERT_X509 (DER)
 - c) EFI_CERT_RSA2048 (bin)
 - d) EFI_CERT_SHAXXX
2. Authenticated UEFI Variable
3. EFI PE/COFF Image (SHA256)
4. Key Source: Factory, External, Mixed.

3.7 Setup Submenu: Boot

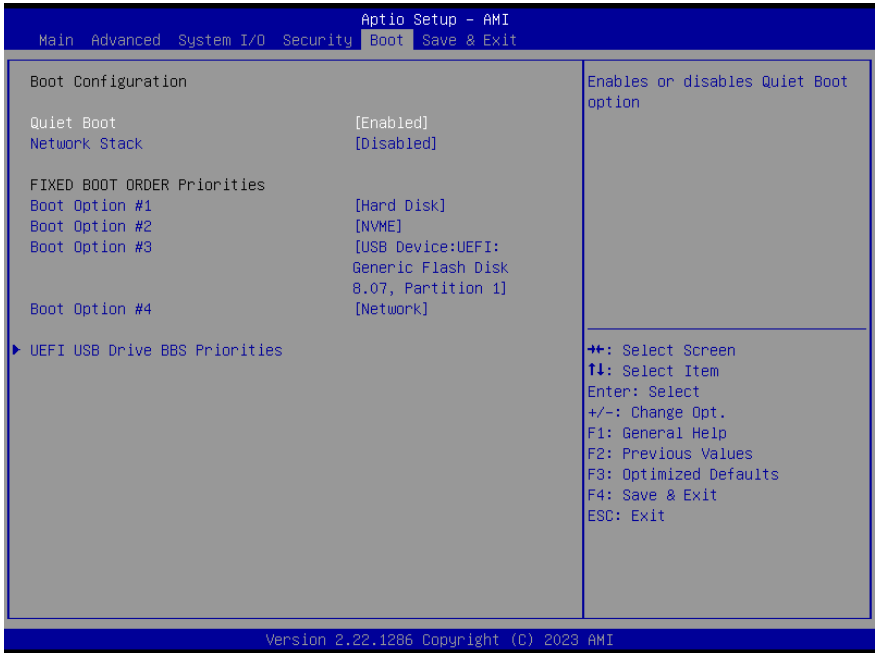

Options Summary		
Quiet Boot	Disabled	
	Enabled	Default
Enables/disables Quiet Boot option.		
Network Stack	Disabled	Default
	Enabled	
Enable/Disable UEFI Network Stack.		
Boot Option #1	Hard Disk	
Boot Option #2	NVME	
Boot Option #3	USB Device	
Boot Option #4	Network	
Sets the system boot order.		

3.7.1 UEFI BBS Priorities

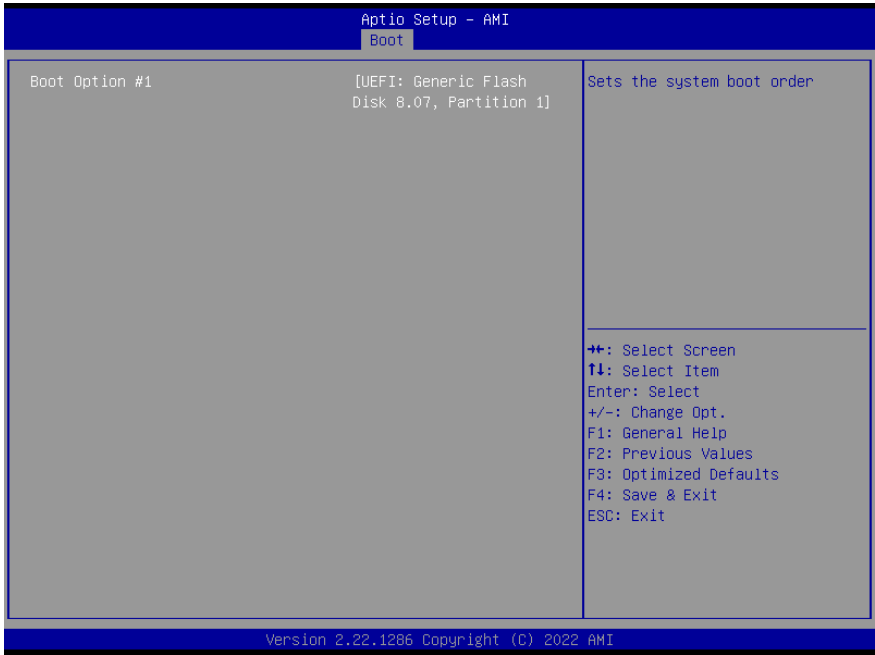

Options Summary		
Quiet Boot	Disabled	
	Enabled	Default
Enables/disables Quiet Boot option.		
Network Stack	Disabled	Default
	Enabled	
Enable/Disable UEFI Network Stack.		
Boot Option #1	Hard Disk	
Boot Option #2	NVME	
Boot Option #3	USB Device	
Boot Option #4	Network	
Sets the system boot order.		

3.8 Setup Submenu: Save & Exit

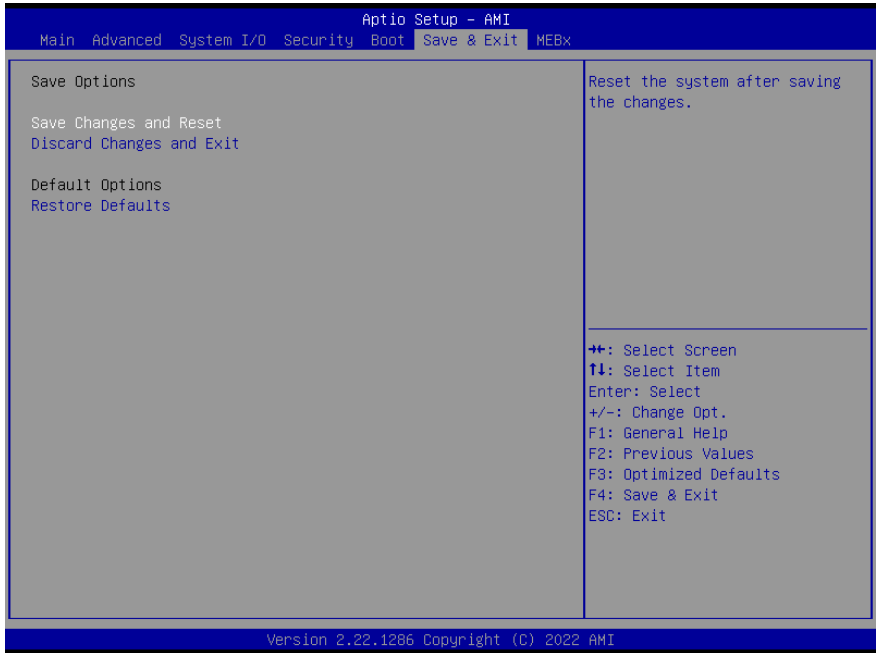

Chapter 4

Drivers Installation

4.1 Drivers Download and Installation

Drivers for the BOXER-6617-ADN can be downloaded from the product page on the AAEON website by following this link:

<https://www.aaeon.com/en/>

Download the driver(s) you need and follow the steps below to install them.

Install Chipset Driver

1. Open the **Chipset** folder and select your OS
2. Run the **SetupChipset.exe** file in the folder
3. Follow the instructions
4. Drivers will be installed automatically

Install Graphics Driver

1. Open the **Graphics** folder and select your OS
2. Run the **Installer.exe** file in the folder
3. Follow the instructions
4. Drivers will be installed automatically

Install Audio Drivers

Note: Ensure Intel Smart Sound Driver (**Intel(R)_SST_ADL_v10.29.00.7919**) is installed before the Realtek Audio driver (**Realtek Audio 6.0.9239.1**)

a. Install Intel Smart Sound Driver

1. Open the **Audio (Intel(R)_SST_ADL_v10.29.00.7919)** folder
2. Follow the setup information within the file to manually install driver.

b. Install Realtek Audio Driver

1. Open the Realtek Audio Driver (**ADSP-10.29.00.8467**) folder
2. Run the **Setup.exe** file in the folder
3. Follow the instructions
4. Driver will be installed automatically

Install LAN Driver

1. Open the **LAN** folder and select your OS
2. Run the **Wired_driver_28.0_x64.exe** file in the folder
3. Follow the instructions
4. Drivers will be installed automatically

Install ME & TXE Driver

1. Open the **ME & TXE** folder and select your OS
2. Run the **SetupME.exe** file in the folder
3. Follow the instructions
4. Drivers will be installed automatically

Install Serial Port Driver (Optional)

1. Open the **Serial Port Driver (Optional)** folder
2. Run the **FintekSerial.exe** file in the folder
3. Follow the instructions
4. Drivers will be installed automatically

Appendix A

I/O Information

A.1 I/O Address Map

DESKTOP-FBGON9F





















































- Input/output (IO)
 - [0000000000000000 - 000000000000CF7] PCI Express Root Complex
 - [0000000000000020 - 0000000000000021] Programmable interrupt controller
 - [0000000000000024 - 0000000000000025] Programmable interrupt controller
 - [0000000000000028 - 0000000000000029] Programmable interrupt controller
 - [000000000000002C - 000000000000002D] Programmable interrupt controller
 - [000000000000002E - 000000000000002F] Motherboard resources
 - [0000000000000030 - 0000000000000031] Programmable interrupt controller
 - [0000000000000034 - 0000000000000035] Programmable interrupt controller
 - [0000000000000038 - 0000000000000039] Programmable interrupt controller
 - [000000000000003C - 000000000000003D] Programmable interrupt controller
 - [0000000000000040 - 0000000000000043] System timer
 - [000000000000004E - 000000000000004F] Motherboard resources
 - [0000000000000050 - 0000000000000053] System timer
 - [0000000000000061 - 0000000000000061] Motherboard resources
 - [0000000000000063 - 0000000000000063] Motherboard resources
 - [0000000000000065 - 0000000000000065] Motherboard resources
 - [0000000000000067 - 0000000000000067] Motherboard resources
 - [0000000000000070 - 0000000000000070] Motherboard resources
 - [0000000000000080 - 0000000000000080] Motherboard resources
 - [0000000000000092 - 0000000000000092] Motherboard resources
 - [00000000000000A0 - 00000000000000A1] Programmable interrupt controller
 - [00000000000000A4 - 00000000000000A5] Programmable interrupt controller
 - [00000000000000A8 - 00000000000000A9] Programmable interrupt controller
 - [00000000000000AC - 00000000000000AD] Programmable interrupt controller
 - [00000000000000B0 - 00000000000000B1] Programmable interrupt controller
 - [00000000000000B2 - 00000000000000B3] Motherboard resources
 - [00000000000000B4 - 00000000000000B5] Programmable interrupt controller
 - [00000000000000B8 - 00000000000000B9] Programmable interrupt controller
 - [00000000000000BC - 00000000000000BD] Programmable interrupt controller
 - [00000000000002C0 - 00000000000002C7] Fintek Communications Port (COM6)
 - [00000000000002D0 - 00000000000002D7] Fintek Communications Port (COM5)
 - [00000000000002E8 - 00000000000002EF] Fintek Communications Port (COM4)
 - [00000000000002F8 - 00000000000002FF] Fintek Communications Port (COM2)
 - [00000000000003E8 - 00000000000003EF] Fintek Communications Port (COM3)
 - [00000000000003F8 - 00000000000003FF] Fintek Communications Port (COM1)
 - [00000000000004D0 - 00000000000004D1] Programmable interrupt controller
 - [0000000000000680 - 000000000000069F] Motherboard resources
 - [0000000000000A00 - 0000000000000A0F] Motherboard resources
 - [0000000000000A10 - 0000000000000A1F] Motherboard resources
 - [0000000000000A20 - 0000000000000A2F] Motherboard resources
 - [0000000000000D00 - 0000000000000FFF] PCI Express Root Complex
 - [000000000000164E - 000000000000164F] Motherboard resources
 - [0000000000001854 - 0000000000001857] Motherboard resources
 - [0000000000002000 - 00000000000020FE] Motherboard resources
 - [0000000000003000 - 000000000000303F] Intel(R) UHD Graphics
 - [0000000000003060 - 000000000000307F] Standard SATA AHCI Controller
 - [0000000000003080 - 0000000000003083] Standard SATA AHCI Controller
 - [0000000000003090 - 0000000000003097] Standard SATA AHCI Controller





















































A.2 Memory Address Map





















































- ▼ DESKTOP-FBGON9F
 - > Input/output (IO)
 - > Interrupt request (IRQ)
 - ▼ Large Memory
 - ▼ Memory
 - [0000004000000000 - 0000007FFFFFFF] PCI Express Root Complex
 - [0000000000A0000 - 0000000000BFFFF] PCI Express Root Complex
 - [0000000080400000 - 00000000804FFFFFF] Intel(R) Ethernet Controller I226-LM
 - [0000000080400000 - 00000000805FFFFFF] PCI Express Root Port #7 - 54BE
 - [0000000080400000 - 00000000BFFFFFFF] PCI Express Root Complex
 - [0000000080500000 - 0000000080503FFF] Intel(R) Ethernet Controller I226-LM
 - [0000000080600000 - 00000000806FFFFFF] Intel(R) Ethernet Controller I226-LM #2
 - [0000000080600000 - 00000000807FFFFFF] PCI Express Root Port #4 - 54BB
 - [0000000080700000 - 0000000080703FFF] Intel(R) Ethernet Controller I226-LM #2
 - [0000000080800000 - 0000000080801FFF] Standard SATA AHCI Controller
 - [0000000080802000 - 00000000808027FF] Standard SATA AHCI Controller
 - [0000000080803000 - 0000000080803FFF] Standard SATA AHCI Controller
 - [00000000C0000000 - 00000000CFFFFFFF] Motherboard resources
 - [00000000FE010000 - 00000000FE010FFF] SPI (flash) Controller - 54A4
 - [00000000FED00000 - 00000000FED003FF] High precision event timer
 - [00000000FED20000 - 00000000FED7FFFF] Motherboard resources
 - [00000000FED40000 - 00000000FED44FFF] Trusted Platform Module 2.0
 - [00000000FED45000 - 00000000FED8FFFF] Motherboard resources
 - [00000000FED90000 - 00000000FED93FFF] Motherboard resources
 - [00000000FEDA0000 - 00000000FEDA0FFF] Motherboard resources
 - [00000000FEDA1000 - 00000000FEDA1FFF] Motherboard resources
 - [00000000FEDC0000 - 00000000FEDC7FFF] Motherboard resources
 - [00000000FEE00000 - 00000000FEEFFFFFFF] Motherboard resources
 - [0000004000000000 - 000000400FFFFFFF] Intel(R) UHD Graphics
 - [0000006000000000 - 0000006000FFFFFFF] Intel(R) UHD Graphics
 - [0000006001100000 - 000000600110FFFF] Intel(R) USB 3.10 eXtensible Host Controller - 1.20 (Microsoft)
 - [0000007FFFEB0000 - 0000007FFFEBFFFF] Intel(R) Management Engine Interface #1
 - [0000007FFFEC0000 - 0000007FFFECFFFF] Intel® Smart Sound Technology BUS
 - [0000007FFFF00000 - 0000007FFFF0FFFF] Intel® Smart Sound Technology BUS





















































A.3 IRQ Mapping Chart





















































▼	Interrupt request (IRQ)
📁	(ISA) 0x00000000 (00) System timer
📁	(ISA) 0x00000003 (03) Fintek Communications Port (COM2)
📁	(ISA) 0x00000004 (04) Fintek Communications Port (COM1)
📁	(ISA) 0x0000000B (11) Fintek Communications Port (COM3)
📁	(ISA) 0x0000000B (11) Fintek Communications Port (COM4)
📁	(ISA) 0x0000000B (11) Fintek Communications Port (COM5)
📁	(ISA) 0x0000000B (11) Fintek Communications Port (COM6)
📁	(ISA) 0x00000037 (55) Microsoft ACPI-Compliant System
📁	(ISA) 0x00000038 (56) Microsoft ACPI-Compliant System
📁	(ISA) 0x00000039 (57) Microsoft ACPI-Compliant System
📁	(ISA) 0x0000003A (58) Microsoft ACPI-Compliant System
📁	(ISA) 0x0000003B (59) Microsoft ACPI-Compliant System
📁	(ISA) 0x0000003C (60) Microsoft ACPI-Compliant System
📁	(ISA) 0x0000003D (61) Microsoft ACPI-Compliant System
📁	(ISA) 0x0000003E (62) Microsoft ACPI-Compliant System
📁	(ISA) 0x0000003F (63) Microsoft ACPI-Compliant System
📁	(ISA) 0x00000040 (64) Microsoft ACPI-Compliant System
📁	(ISA) 0x00000041 (65) Microsoft ACPI-Compliant System
📁	(ISA) 0x00000042 (66) Microsoft ACPI-Compliant System
📁	(ISA) 0x00000043 (67) Microsoft ACPI-Compliant System
📁	(ISA) 0x00000044 (68) Microsoft ACPI-Compliant System
📁	(ISA) 0x00000045 (69) Microsoft ACPI-Compliant System
📁	(ISA) 0x00000046 (70) Microsoft ACPI-Compliant System
📁	(ISA) 0x00000047 (71) Microsoft ACPI-Compliant System
📁	(ISA) 0x00000048 (72) Microsoft ACPI-Compliant System
📁	(ISA) 0x00000049 (73) Microsoft ACPI-Compliant System
📁	(ISA) 0x0000004A (74) Microsoft ACPI-Compliant System
📁	(ISA) 0x0000004B (75) Microsoft ACPI-Compliant System
📁	(ISA) 0x0000004C (76) Microsoft ACPI-Compliant System
📁	(ISA) 0x0000004D (77) Microsoft ACPI-Compliant System
📁	(ISA) 0x0000004E (78) Microsoft ACPI-Compliant System
📁	(ISA) 0x0000004F (79) Microsoft ACPI-Compliant System
📁	(ISA) 0x00000050 (80) Microsoft ACPI-Compliant System
📁	(ISA) 0x00000051 (81) Microsoft ACPI-Compliant System
📁	(ISA) 0x00000052 (82) Microsoft ACPI-Compliant System
📁	(ISA) 0x00000053 (83) Microsoft ACPI-Compliant System
📁	(ISA) 0x00000054 (84) Microsoft ACPI-Compliant System
📁	(ISA) 0x00000055 (85) Microsoft ACPI-Compliant System
📁	(ISA) 0x00000056 (86) Microsoft ACPI-Compliant System
📁	(ISA) 0x00000057 (87) Microsoft ACPI-Compliant System
📁	(ISA) 0x00000058 (88) Microsoft ACPI-Compliant System
📁	(ISA) 0x00000059 (89) Microsoft ACPI-Compliant System
📁	(ISA) 0x0000005A (90) Microsoft ACPI-Compliant System
📁	(ISA) 0x0000005B (91) Microsoft ACPI-Compliant System
📁	(ISA) 0x0000005C (92) Microsoft ACPI-Compliant System
📁	(ISA) 0x0000005D (93) Microsoft ACPI-Compliant System
📁	(ISA) 0x0000005E (94) Microsoft ACPI-Compliant System
📁	(ISA) 0x0000005F (95) Microsoft ACPI-Compliant System
📁	(ISA) 0x00000060 (96) Microsoft ACPI-Compliant System
📁	(ISA) 0x00000061 (97) Microsoft ACPI-Compliant System
📁	(ISA) 0x00000062 (98) Microsoft ACPI-Compliant System





















































 (ISA) 0x00000063 (99)	Microsoft ACPI-Compliant System
 (ISA) 0x00000064 (100)	Microsoft ACPI-Compliant System
 (ISA) 0x00000065 (101)	Microsoft ACPI-Compliant System
 (ISA) 0x00000066 (102)	Microsoft ACPI-Compliant System
 (ISA) 0x00000067 (103)	Microsoft ACPI-Compliant System
 (ISA) 0x00000068 (104)	Microsoft ACPI-Compliant System
 (ISA) 0x00000069 (105)	Microsoft ACPI-Compliant System
 (ISA) 0x0000006A (106)	Microsoft ACPI-Compliant System
 (ISA) 0x0000006B (107)	Microsoft ACPI-Compliant System
 (ISA) 0x0000006C (108)	Microsoft ACPI-Compliant System
 (ISA) 0x0000006D (109)	Microsoft ACPI-Compliant System
 (ISA) 0x0000006E (110)	Microsoft ACPI-Compliant System
 (ISA) 0x0000006F (111)	Microsoft ACPI-Compliant System
 (ISA) 0x00000070 (112)	Microsoft ACPI-Compliant System
 (ISA) 0x00000071 (113)	Microsoft ACPI-Compliant System
 (ISA) 0x00000072 (114)	Microsoft ACPI-Compliant System
 (ISA) 0x00000073 (115)	Microsoft ACPI-Compliant System
 (ISA) 0x00000074 (116)	Microsoft ACPI-Compliant System
 (ISA) 0x00000075 (117)	Microsoft ACPI-Compliant System
 (ISA) 0x00000076 (118)	Microsoft ACPI-Compliant System
 (ISA) 0x00000077 (119)	Microsoft ACPI-Compliant System
 (ISA) 0x00000078 (120)	Microsoft ACPI-Compliant System
 (ISA) 0x00000079 (121)	Microsoft ACPI-Compliant System
 (ISA) 0x0000007A (122)	Microsoft ACPI-Compliant System
 (ISA) 0x0000007B (123)	Microsoft ACPI-Compliant System
 (ISA) 0x0000007C (124)	Microsoft ACPI-Compliant System
 (ISA) 0x0000007D (125)	Microsoft ACPI-Compliant System
 (ISA) 0x0000007E (126)	Microsoft ACPI-Compliant System
 (ISA) 0x0000007F (127)	Microsoft ACPI-Compliant System
 (ISA) 0x00000080 (128)	Microsoft ACPI-Compliant System
 (ISA) 0x00000081 (129)	Microsoft ACPI-Compliant System
 (ISA) 0x00000082 (130)	Microsoft ACPI-Compliant System
 (ISA) 0x00000083 (131)	Microsoft ACPI-Compliant System
 (ISA) 0x00000084 (132)	Microsoft ACPI-Compliant System
 (ISA) 0x00000085 (133)	Microsoft ACPI-Compliant System
 (ISA) 0x00000086 (134)	Microsoft ACPI-Compliant System
 (ISA) 0x00000087 (135)	Microsoft ACPI-Compliant System
 (ISA) 0x00000088 (136)	Microsoft ACPI-Compliant System
 (ISA) 0x00000089 (137)	Microsoft ACPI-Compliant System
 (ISA) 0x0000008A (138)	Microsoft ACPI-Compliant System
 (ISA) 0x0000008B (139)	Microsoft ACPI-Compliant System
 (ISA) 0x0000008C (140)	Microsoft ACPI-Compliant System
 (ISA) 0x0000008D (141)	Microsoft ACPI-Compliant System
 (ISA) 0x0000008E (142)	Microsoft ACPI-Compliant System
 (ISA) 0x0000008F (143)	Microsoft ACPI-Compliant System
 (ISA) 0x00000090 (144)	Microsoft ACPI-Compliant System
 (ISA) 0x00000091 (145)	Microsoft ACPI-Compliant System
 (ISA) 0x00000092 (146)	Microsoft ACPI-Compliant System
 (ISA) 0x00000093 (147)	Microsoft ACPI-Compliant System
 (ISA) 0x00000094 (148)	Microsoft ACPI-Compliant System
 (ISA) 0x00000095 (149)	Microsoft ACPI-Compliant System
 (ISA) 0x00000096 (150)	Microsoft ACPI-Compliant System







































 (ISA) 0x00000097 (151)	Microsoft ACPI-Compliant System
 (ISA) 0x00000098 (152)	Microsoft ACPI-Compliant System
 (ISA) 0x00000099 (153)	Microsoft ACPI-Compliant System
 (ISA) 0x0000009A (154)	Microsoft ACPI-Compliant System
 (ISA) 0x0000009B (155)	Microsoft ACPI-Compliant System
 (ISA) 0x0000009C (156)	Microsoft ACPI-Compliant System
 (ISA) 0x0000009D (157)	Microsoft ACPI-Compliant System
 (ISA) 0x0000009E (158)	Microsoft ACPI-Compliant System
 (ISA) 0x0000009F (159)	Microsoft ACPI-Compliant System
 (ISA) 0x000000A0 (160)	Microsoft ACPI-Compliant System
 (ISA) 0x000000A1 (161)	Microsoft ACPI-Compliant System
 (ISA) 0x000000A2 (162)	Microsoft ACPI-Compliant System
 (ISA) 0x000000A3 (163)	Microsoft ACPI-Compliant System
 (ISA) 0x000000A4 (164)	Microsoft ACPI-Compliant System
 (ISA) 0x000000A5 (165)	Microsoft ACPI-Compliant System
 (ISA) 0x000000A6 (166)	Microsoft ACPI-Compliant System
 (ISA) 0x000000A7 (167)	Microsoft ACPI-Compliant System
 (ISA) 0x000000A8 (168)	Microsoft ACPI-Compliant System
 (ISA) 0x000000A9 (169)	Microsoft ACPI-Compliant System
 (ISA) 0x000000AA (170)	Microsoft ACPI-Compliant System
 (ISA) 0x000000AB (171)	Microsoft ACPI-Compliant System
 (ISA) 0x000000AC (172)	Microsoft ACPI-Compliant System
 (ISA) 0x000000AD (173)	Microsoft ACPI-Compliant System
 (ISA) 0x000000AE (174)	Microsoft ACPI-Compliant System
 (ISA) 0x000000AF (175)	Microsoft ACPI-Compliant System
 (ISA) 0x000000B0 (176)	Microsoft ACPI-Compliant System
 (ISA) 0x000000B1 (177)	Microsoft ACPI-Compliant System
 (ISA) 0x000000B2 (178)	Microsoft ACPI-Compliant System
 (ISA) 0x000000B3 (179)	Microsoft ACPI-Compliant System
 (ISA) 0x000000B4 (180)	Microsoft ACPI-Compliant System
 (ISA) 0x000000B5 (181)	Microsoft ACPI-Compliant System
 (ISA) 0x000000B6 (182)	Microsoft ACPI-Compliant System
 (ISA) 0x000000B7 (183)	Microsoft ACPI-Compliant System
 (ISA) 0x000000B8 (184)	Microsoft ACPI-Compliant System
 (ISA) 0x000000B9 (185)	Microsoft ACPI-Compliant System
 (ISA) 0x000000BA (186)	Microsoft ACPI-Compliant System
 (ISA) 0x000000BB (187)	Microsoft ACPI-Compliant System
 (ISA) 0x000000BC (188)	Microsoft ACPI-Compliant System
 (ISA) 0x000000BD (189)	Microsoft ACPI-Compliant System
 (ISA) 0x000000BE (190)	Microsoft ACPI-Compliant System
 (ISA) 0x000000BF (191)	Microsoft ACPI-Compliant System
 (ISA) 0x000000C0 (192)	Microsoft ACPI-Compliant System
 (ISA) 0x000000C1 (193)	Microsoft ACPI-Compliant System
 (ISA) 0x000000C2 (194)	Microsoft ACPI-Compliant System
 (ISA) 0x000000C3 (195)	Microsoft ACPI-Compliant System
 (ISA) 0x000000C4 (196)	Microsoft ACPI-Compliant System
 (ISA) 0x000000C5 (197)	Microsoft ACPI-Compliant System
 (ISA) 0x000000C6 (198)	Microsoft ACPI-Compliant System
 (ISA) 0x000000C7 (199)	Microsoft ACPI-Compliant System
 (ISA) 0x000000C8 (200)	Microsoft ACPI-Compliant System
 (ISA) 0x000000C9 (201)	Microsoft ACPI-Compliant System
 (ISA) 0x000000CA (202)	Microsoft ACPI-Compliant System



























 (ISA) 0x000000CB (203)	Microsoft ACPI-Compliant System
 (ISA) 0x000000CC (204)	Microsoft ACPI-Compliant System
 (ISA) 0x00000100 (256)	Microsoft ACPI-Compliant System
 (ISA) 0x00000101 (257)	Microsoft ACPI-Compliant System
 (ISA) 0x00000102 (258)	Microsoft ACPI-Compliant System
 (ISA) 0x00000103 (259)	Microsoft ACPI-Compliant System
 (ISA) 0x00000104 (260)	Microsoft ACPI-Compliant System
 (ISA) 0x00000105 (261)	Microsoft ACPI-Compliant System
 (ISA) 0x00000106 (262)	Microsoft ACPI-Compliant System
 (ISA) 0x00000107 (263)	Microsoft ACPI-Compliant System
 (ISA) 0x00000108 (264)	Microsoft ACPI-Compliant System
 (ISA) 0x00000109 (265)	Microsoft ACPI-Compliant System
 (ISA) 0x0000010A (266)	Microsoft ACPI-Compliant System
 (ISA) 0x0000010B (267)	Microsoft ACPI-Compliant System
 (ISA) 0x0000010C (268)	Microsoft ACPI-Compliant System
 (ISA) 0x0000010D (269)	Microsoft ACPI-Compliant System
 (ISA) 0x0000010E (270)	Microsoft ACPI-Compliant System
 (ISA) 0x0000010F (271)	Microsoft ACPI-Compliant System
 (ISA) 0x00000110 (272)	Microsoft ACPI-Compliant System
 (ISA) 0x00000111 (273)	Microsoft ACPI-Compliant System
 (ISA) 0x00000112 (274)	Microsoft ACPI-Compliant System
 (ISA) 0x00000113 (275)	Microsoft ACPI-Compliant System
 (ISA) 0x00000114 (276)	Microsoft ACPI-Compliant System
 (ISA) 0x00000115 (277)	Microsoft ACPI-Compliant System
 (ISA) 0x00000116 (278)	Microsoft ACPI-Compliant System
 (ISA) 0x00000117 (279)	Microsoft ACPI-Compliant System
 (ISA) 0x00000118 (280)	Microsoft ACPI-Compliant System
 (ISA) 0x00000119 (281)	Microsoft ACPI-Compliant System
 (ISA) 0x0000011A (282)	Microsoft ACPI-Compliant System
 (ISA) 0x0000011B (283)	Microsoft ACPI-Compliant System
 (ISA) 0x0000011C (284)	Microsoft ACPI-Compliant System
 (ISA) 0x0000011D (285)	Microsoft ACPI-Compliant System
 (ISA) 0x0000011E (286)	Microsoft ACPI-Compliant System
 (ISA) 0x0000011F (287)	Microsoft ACPI-Compliant System
 (ISA) 0x00000120 (288)	Microsoft ACPI-Compliant System
 (ISA) 0x00000121 (289)	Microsoft ACPI-Compliant System
 (ISA) 0x00000122 (290)	Microsoft ACPI-Compliant System
 (ISA) 0x00000123 (291)	Microsoft ACPI-Compliant System
 (ISA) 0x00000124 (292)	Microsoft ACPI-Compliant System
 (ISA) 0x00000125 (293)	Microsoft ACPI-Compliant System
 (ISA) 0x00000126 (294)	Microsoft ACPI-Compliant System
 (ISA) 0x00000127 (295)	Microsoft ACPI-Compliant System
 (ISA) 0x00000128 (296)	Microsoft ACPI-Compliant System
 (ISA) 0x00000129 (297)	Microsoft ACPI-Compliant System
 (ISA) 0x0000012A (298)	Microsoft ACPI-Compliant System
 (ISA) 0x0000012B (299)	Microsoft ACPI-Compliant System
 (ISA) 0x0000012C (300)	Microsoft ACPI-Compliant System
 (ISA) 0x0000012D (301)	Microsoft ACPI-Compliant System
 (ISA) 0x0000012E (302)	Microsoft ACPI-Compliant System
 (ISA) 0x0000012F (303)	Microsoft ACPI-Compliant System
 (ISA) 0x00000130 (304)	Microsoft ACPI-Compliant System
 (ISA) 0x00000131 (305)	Microsoft ACPI-Compliant System

 (ISA) 0x00000132 (306)	Microsoft ACPI-Compliant System
 (ISA) 0x00000133 (307)	Microsoft ACPI-Compliant System
 (ISA) 0x00000134 (308)	Microsoft ACPI-Compliant System
 (ISA) 0x00000135 (309)	Microsoft ACPI-Compliant System
 (ISA) 0x00000136 (310)	Microsoft ACPI-Compliant System
 (ISA) 0x00000137 (311)	Microsoft ACPI-Compliant System
 (ISA) 0x00000138 (312)	Microsoft ACPI-Compliant System
 (ISA) 0x00000139 (313)	Microsoft ACPI-Compliant System
 (ISA) 0x0000013A (314)	Microsoft ACPI-Compliant System
 (ISA) 0x0000013B (315)	Microsoft ACPI-Compliant System
 (ISA) 0x0000013C (316)	Microsoft ACPI-Compliant System
 (ISA) 0x0000013D (317)	Microsoft ACPI-Compliant System
 (ISA) 0x0000013E (318)	Microsoft ACPI-Compliant System
 (ISA) 0x0000013F (319)	Microsoft ACPI-Compliant System
 (ISA) 0x00000140 (320)	Microsoft ACPI-Compliant System
 (ISA) 0x00000141 (321)	Microsoft ACPI-Compliant System
 (ISA) 0x00000142 (322)	Microsoft ACPI-Compliant System
 (ISA) 0x00000143 (323)	Microsoft ACPI-Compliant System
 (ISA) 0x00000144 (324)	Microsoft ACPI-Compliant System
 (ISA) 0x00000145 (325)	Microsoft ACPI-Compliant System
 (ISA) 0x00000146 (326)	Microsoft ACPI-Compliant System
 (ISA) 0x00000147 (327)	Microsoft ACPI-Compliant System
 (ISA) 0x00000148 (328)	Microsoft ACPI-Compliant System
 (ISA) 0x00000149 (329)	Microsoft ACPI-Compliant System
 (ISA) 0x0000014A (330)	Microsoft ACPI-Compliant System
 (ISA) 0x0000014B (331)	Microsoft ACPI-Compliant System
 (ISA) 0x0000014C (332)	Microsoft ACPI-Compliant System
 (ISA) 0x0000014D (333)	Microsoft ACPI-Compliant System
 (ISA) 0x0000014E (334)	Microsoft ACPI-Compliant System
 (ISA) 0x0000014F (335)	Microsoft ACPI-Compliant System
 (ISA) 0x00000150 (336)	Microsoft ACPI-Compliant System
 (ISA) 0x00000151 (337)	Microsoft ACPI-Compliant System
 (ISA) 0x00000152 (338)	Microsoft ACPI-Compliant System
 (ISA) 0x00000153 (339)	Microsoft ACPI-Compliant System
 (ISA) 0x00000154 (340)	Microsoft ACPI-Compliant System
 (ISA) 0x00000155 (341)	Microsoft ACPI-Compliant System
 (ISA) 0x00000156 (342)	Microsoft ACPI-Compliant System
 (ISA) 0x00000157 (343)	Microsoft ACPI-Compliant System
 (ISA) 0x00000158 (344)	Microsoft ACPI-Compliant System
 (ISA) 0x00000159 (345)	Microsoft ACPI-Compliant System
 (ISA) 0x0000015A (346)	Microsoft ACPI-Compliant System
 (ISA) 0x0000015B (347)	Microsoft ACPI-Compliant System
 (ISA) 0x0000015C (348)	Microsoft ACPI-Compliant System
 (ISA) 0x0000015D (349)	Microsoft ACPI-Compliant System
 (ISA) 0x0000015E (350)	Microsoft ACPI-Compliant System
 (ISA) 0x0000015F (351)	Microsoft ACPI-Compliant System
 (ISA) 0x00000160 (352)	Microsoft ACPI-Compliant System
 (ISA) 0x00000161 (353)	Microsoft ACPI-Compliant System
 (ISA) 0x00000162 (354)	Microsoft ACPI-Compliant System
 (ISA) 0x00000163 (355)	Microsoft ACPI-Compliant System
 (ISA) 0x00000164 (356)	Microsoft ACPI-Compliant System
 (ISA) 0x00000165 (357)	Microsoft ACPI-Compliant System

 (ISA) 0x00000166 (358)	Microsoft ACPI-Compliant System
 (ISA) 0x00000167 (359)	Microsoft ACPI-Compliant System
 (ISA) 0x00000168 (360)	Microsoft ACPI-Compliant System
 (ISA) 0x00000169 (361)	Microsoft ACPI-Compliant System
 (ISA) 0x0000016A (362)	Microsoft ACPI-Compliant System
 (ISA) 0x0000016B (363)	Microsoft ACPI-Compliant System
 (ISA) 0x0000016C (364)	Microsoft ACPI-Compliant System
 (ISA) 0x0000016D (365)	Microsoft ACPI-Compliant System
 (ISA) 0x0000016E (366)	Microsoft ACPI-Compliant System
 (ISA) 0x0000016F (367)	Microsoft ACPI-Compliant System
 (ISA) 0x00000170 (368)	Microsoft ACPI-Compliant System
 (ISA) 0x00000171 (369)	Microsoft ACPI-Compliant System
 (ISA) 0x00000172 (370)	Microsoft ACPI-Compliant System
 (ISA) 0x00000173 (371)	Microsoft ACPI-Compliant System
 (ISA) 0x00000174 (372)	Microsoft ACPI-Compliant System
 (ISA) 0x00000175 (373)	Microsoft ACPI-Compliant System
 (ISA) 0x00000176 (374)	Microsoft ACPI-Compliant System
 (ISA) 0x00000177 (375)	Microsoft ACPI-Compliant System
 (ISA) 0x00000178 (376)	Microsoft ACPI-Compliant System
 (ISA) 0x00000179 (377)	Microsoft ACPI-Compliant System
 (ISA) 0x0000017A (378)	Microsoft ACPI-Compliant System
 (ISA) 0x0000017B (379)	Microsoft ACPI-Compliant System
 (ISA) 0x0000017C (380)	Microsoft ACPI-Compliant System
 (ISA) 0x0000017D (381)	Microsoft ACPI-Compliant System
 (ISA) 0x0000017E (382)	Microsoft ACPI-Compliant System
 (ISA) 0x0000017F (383)	Microsoft ACPI-Compliant System
 (ISA) 0x00000180 (384)	Microsoft ACPI-Compliant System
 (ISA) 0x00000181 (385)	Microsoft ACPI-Compliant System
 (ISA) 0x00000182 (386)	Microsoft ACPI-Compliant System
 (ISA) 0x00000183 (387)	Microsoft ACPI-Compliant System
 (ISA) 0x00000184 (388)	Microsoft ACPI-Compliant System
 (ISA) 0x00000185 (389)	Microsoft ACPI-Compliant System
 (ISA) 0x00000186 (390)	Microsoft ACPI-Compliant System
 (ISA) 0x00000187 (391)	Microsoft ACPI-Compliant System
 (ISA) 0x00000188 (392)	Microsoft ACPI-Compliant System
 (ISA) 0x00000189 (393)	Microsoft ACPI-Compliant System
 (ISA) 0x0000018A (394)	Microsoft ACPI-Compliant System
 (ISA) 0x0000018B (395)	Microsoft ACPI-Compliant System
 (ISA) 0x0000018C (396)	Microsoft ACPI-Compliant System
 (ISA) 0x0000018D (397)	Microsoft ACPI-Compliant System
 (ISA) 0x0000018E (398)	Microsoft ACPI-Compliant System
 (ISA) 0x0000018F (399)	Microsoft ACPI-Compliant System
 (ISA) 0x00000190 (400)	Microsoft ACPI-Compliant System
 (ISA) 0x00000191 (401)	Microsoft ACPI-Compliant System
 (ISA) 0x00000192 (402)	Microsoft ACPI-Compliant System
 (ISA) 0x00000193 (403)	Microsoft ACPI-Compliant System
 (ISA) 0x00000194 (404)	Microsoft ACPI-Compliant System
 (ISA) 0x00000195 (405)	Microsoft ACPI-Compliant System
 (ISA) 0x00000196 (406)	Microsoft ACPI-Compliant System
 (ISA) 0x00000197 (407)	Microsoft ACPI-Compliant System
 (ISA) 0x00000198 (408)	Microsoft ACPI-Compliant System
 (ISA) 0x00000199 (409)	Microsoft ACPI-Compliant System

 (ISA) 0x0000019A (410)	Microsoft ACPI-Compliant System
 (ISA) 0x0000019B (411)	Microsoft ACPI-Compliant System
 (ISA) 0x0000019C (412)	Microsoft ACPI-Compliant System
 (ISA) 0x0000019D (413)	Microsoft ACPI-Compliant System
 (ISA) 0x0000019E (414)	Microsoft ACPI-Compliant System
 (ISA) 0x0000019F (415)	Microsoft ACPI-Compliant System
 (ISA) 0x000001A0 (416)	Microsoft ACPI-Compliant System
 (ISA) 0x000001A1 (417)	Microsoft ACPI-Compliant System
 (ISA) 0x000001A2 (418)	Microsoft ACPI-Compliant System
 (ISA) 0x000001A3 (419)	Microsoft ACPI-Compliant System
 (ISA) 0x000001A4 (420)	Microsoft ACPI-Compliant System
 (ISA) 0x000001A5 (421)	Microsoft ACPI-Compliant System
 (ISA) 0x000001A6 (422)	Microsoft ACPI-Compliant System
 (ISA) 0x000001A7 (423)	Microsoft ACPI-Compliant System
 (ISA) 0x000001A8 (424)	Microsoft ACPI-Compliant System
 (ISA) 0x000001A9 (425)	Microsoft ACPI-Compliant System
 (ISA) 0x000001AA (426)	Microsoft ACPI-Compliant System
 (ISA) 0x000001AB (427)	Microsoft ACPI-Compliant System
 (ISA) 0x000001AC (428)	Microsoft ACPI-Compliant System
 (ISA) 0x000001AD (429)	Microsoft ACPI-Compliant System
 (ISA) 0x000001AE (430)	Microsoft ACPI-Compliant System
 (ISA) 0x000001AF (431)	Microsoft ACPI-Compliant System
 (ISA) 0x000001B0 (432)	Microsoft ACPI-Compliant System
 (ISA) 0x000001B1 (433)	Microsoft ACPI-Compliant System
 (ISA) 0x000001B2 (434)	Microsoft ACPI-Compliant System
 (ISA) 0x000001B3 (435)	Microsoft ACPI-Compliant System
 (ISA) 0x000001B4 (436)	Microsoft ACPI-Compliant System
 (ISA) 0x000001B5 (437)	Microsoft ACPI-Compliant System
 (ISA) 0x000001B6 (438)	Microsoft ACPI-Compliant System
 (ISA) 0x000001B7 (439)	Microsoft ACPI-Compliant System
 (ISA) 0x000001B8 (440)	Microsoft ACPI-Compliant System
 (ISA) 0x000001B9 (441)	Microsoft ACPI-Compliant System
 (ISA) 0x000001BA (442)	Microsoft ACPI-Compliant System
 (ISA) 0x000001BB (443)	Microsoft ACPI-Compliant System
 (ISA) 0x000001BC (444)	Microsoft ACPI-Compliant System
 (ISA) 0x000001BD (445)	Microsoft ACPI-Compliant System
 (ISA) 0x000001BE (446)	Microsoft ACPI-Compliant System
 (ISA) 0x000001BF (447)	Microsoft ACPI-Compliant System
 (ISA) 0x000001C0 (448)	Microsoft ACPI-Compliant System
 (ISA) 0x000001C1 (449)	Microsoft ACPI-Compliant System
 (ISA) 0x000001C2 (450)	Microsoft ACPI-Compliant System
 (ISA) 0x000001C3 (451)	Microsoft ACPI-Compliant System
 (ISA) 0x000001C4 (452)	Microsoft ACPI-Compliant System
 (ISA) 0x000001C5 (453)	Microsoft ACPI-Compliant System
 (ISA) 0x000001C6 (454)	Microsoft ACPI-Compliant System
 (ISA) 0x000001C7 (455)	Microsoft ACPI-Compliant System
 (ISA) 0x000001C8 (456)	Microsoft ACPI-Compliant System
 (ISA) 0x000001C9 (457)	Microsoft ACPI-Compliant System
 (ISA) 0x000001CA (458)	Microsoft ACPI-Compliant System
 (ISA) 0x000001CB (459)	Microsoft ACPI-Compliant System
 (ISA) 0x000001CC (460)	Microsoft ACPI-Compliant System
 (ISA) 0x000001CD (461)	Microsoft ACPI-Compliant System

 (ISA) 0x000001CE (462)	Microsoft ACPI-Compliant System
 (ISA) 0x000001CF (463)	Microsoft ACPI-Compliant System
 (ISA) 0x000001D0 (464)	Microsoft ACPI-Compliant System
 (ISA) 0x000001D1 (465)	Microsoft ACPI-Compliant System
 (ISA) 0x000001D2 (466)	Microsoft ACPI-Compliant System
 (ISA) 0x000001D3 (467)	Microsoft ACPI-Compliant System
 (ISA) 0x000001D4 (468)	Microsoft ACPI-Compliant System
 (ISA) 0x000001D5 (469)	Microsoft ACPI-Compliant System
 (ISA) 0x000001D6 (470)	Microsoft ACPI-Compliant System
 (ISA) 0x000001D7 (471)	Microsoft ACPI-Compliant System
 (ISA) 0x000001D8 (472)	Microsoft ACPI-Compliant System
 (ISA) 0x000001D9 (473)	Microsoft ACPI-Compliant System
 (ISA) 0x000001DA (474)	Microsoft ACPI-Compliant System
 (ISA) 0x000001DB (475)	Microsoft ACPI-Compliant System
 (ISA) 0x000001DC (476)	Microsoft ACPI-Compliant System
 (ISA) 0x000001DD (477)	Microsoft ACPI-Compliant System
 (ISA) 0x000001DE (478)	Microsoft ACPI-Compliant System
 (ISA) 0x000001DF (479)	Microsoft ACPI-Compliant System
 (ISA) 0x000001E0 (480)	Microsoft ACPI-Compliant System
 (ISA) 0x000001E1 (481)	Microsoft ACPI-Compliant System
 (ISA) 0x000001E2 (482)	Microsoft ACPI-Compliant System
 (ISA) 0x000001E3 (483)	Microsoft ACPI-Compliant System
 (ISA) 0x000001E4 (484)	Microsoft ACPI-Compliant System
 (ISA) 0x000001E5 (485)	Microsoft ACPI-Compliant System
 (ISA) 0x000001E6 (486)	Microsoft ACPI-Compliant System
 (ISA) 0x000001E7 (487)	Microsoft ACPI-Compliant System
 (ISA) 0x000001E8 (488)	Microsoft ACPI-Compliant System
 (ISA) 0x000001E9 (489)	Microsoft ACPI-Compliant System
 (ISA) 0x000001EA (490)	Microsoft ACPI-Compliant System
 (ISA) 0x000001EB (491)	Microsoft ACPI-Compliant System
 (ISA) 0x000001EC (492)	Microsoft ACPI-Compliant System
 (ISA) 0x000001ED (493)	Microsoft ACPI-Compliant System
 (ISA) 0x000001EE (494)	Microsoft ACPI-Compliant System
 (ISA) 0x000001EF (495)	Microsoft ACPI-Compliant System
 (ISA) 0x000001F0 (496)	Microsoft ACPI-Compliant System
 (ISA) 0x000001F1 (497)	Microsoft ACPI-Compliant System
 (ISA) 0x000001F2 (498)	Microsoft ACPI-Compliant System
 (ISA) 0x000001F3 (499)	Microsoft ACPI-Compliant System
 (ISA) 0x000001F4 (500)	Microsoft ACPI-Compliant System

 (ISA) 0x000001F5 (501)	Microsoft ACPI-Compliant System
 (ISA) 0x000001F6 (502)	Microsoft ACPI-Compliant System
 (ISA) 0x000001F7 (503)	Microsoft ACPI-Compliant System
 (ISA) 0x000001F8 (504)	Microsoft ACPI-Compliant System
 (ISA) 0x000001F9 (505)	Microsoft ACPI-Compliant System
 (ISA) 0x000001FA (506)	Microsoft ACPI-Compliant System
 (ISA) 0x000001FB (507)	Microsoft ACPI-Compliant System
 (ISA) 0x000001FC (508)	Microsoft ACPI-Compliant System
 (ISA) 0x000001FD (509)	Microsoft ACPI-Compliant System
 (ISA) 0x000001FE (510)	Microsoft ACPI-Compliant System
 (ISA) 0x000001FF (511)	Microsoft ACPI-Compliant System
 (PCI) 0xFFFFFFFF0 (-16)	Intel(R) Management Engine Interface #1
 (PCI) 0xFFFFFFFF1 (-15)	Intel® Smart Sound Technology BUS
 (PCI) 0xFFFFFFFF2 (-14)	Intel(R) Ethernet Controller I226-LM
 (PCI) 0xFFFFFFFF3 (-13)	Intel(R) Ethernet Controller I226-LM
 (PCI) 0xFFFFFFFF4 (-12)	Intel(R) Ethernet Controller I226-LM
 (PCI) 0xFFFFFFFF5 (-11)	Intel(R) Ethernet Controller I226-LM
 (PCI) 0xFFFFFFFF6 (-10)	Intel(R) Ethernet Controller I226-LM
 (PCI) 0xFFFFFFFF7 (-9)	Intel(R) Ethernet Controller I226-LM #2
 (PCI) 0xFFFFFFFF8 (-8)	Intel(R) Ethernet Controller I226-LM #2
 (PCI) 0xFFFFFFFF9 (-7)	Intel(R) Ethernet Controller I226-LM #2
 (PCI) 0xFFFFFFFFA (-6)	Intel(R) Ethernet Controller I226-LM #2
 (PCI) 0xFFFFFFFFB (-5)	Intel(R) Ethernet Controller I226-LM #2
 (PCI) 0xFFFFFFFFC (-4)	Intel(R) USB 3.10 eXtensible Host Controller - 1.20 (Microsoft)
 (PCI) 0xFFFFFFFFD (-3)	Intel(R) UHD Graphics
 (PCI) 0xFFFFFFFFE (-2)	Standard SATA AHCI Controller