

BOXER-6616

Fanless Embedded Box PC

User's Manual 3rd Ed

Copyright Notice

This document is copyrighted, 2018. All rights are reserved. The original manufacturer reserves the right to make improvements to the products described in this manual at any time without notice.

No part of this manual may be reproduced, copied, translated, or transmitted in any form or by any means without the prior written permission of the original manufacturer. Information provided in this manual is intended to be accurate and reliable. However, the original manufacturer assumes no responsibility for its use, or for any infringements upon the rights of third parties that may result from its use.

The material in this document is for product information only and is subject to change without notice. While reasonable efforts have been made in the preparation of this document to assure its accuracy, AAEMON assumes no liabilities resulting from errors or omissions in this document, or from the use of the information contained herein.

AAEMON reserves the right to make changes in the product design without notice to its users.

Acknowledgement

All other products' name or trademarks are properties of their respective owners.

- Microsoft Windows® is a registered trademark of Microsoft Corp.
- Intel®, Pentium®, Celeron®, and Xeon® are registered trademarks of Intel Corporation
- Atom™ is a trademark of Intel Corporation

All other product names or trademarks are properties of their respective owners.

Packing List

Before setting up your product, please make sure the following items have been shipped:

Item	Quantity
● BOXER-6616	1
● Wallmount bracket	2
● Screw Package	1
● Phoenix power connector	1
● Product DVD with User's Manual (in pdf) and drivers	1

If any of these items are missing or damaged, please contact your distributor or sales representative immediately.

About this Document

This User's Manual contains all the essential information, such as detailed descriptions and explanations on the product's hardware and software features (if any), its specifications, dimensions, jumper/connector settings/definitions, and driver installation instructions (if any), to facilitate users in setting up their product.

Users may refer to the AAEON.com for the latest version of this document.

Safety Precautions

Please read the following safety instructions carefully. It is advised that you keep this manual for future references

1. All cautions and warnings on the device should be noted.
2. Make sure the power source matches the power rating of the device.
3. Position the power cord so that people cannot step on it. Do not place anything over the power cord.
4. Always completely disconnect the power before working on the system's hardware.
5. No connections should be made when the system is powered as a sudden rush of power may damage sensitive electronic components.
6. If the device is not to be used for a long time, disconnect it from the power supply to avoid damage by transient over-voltage.
7. Always disconnect this device from any power supply before cleaning.
8. While cleaning, use a damp cloth instead of liquid or spray detergents.
9. Make sure the device is installed near a power outlet and is easily accessible.
10. Keep this device away from humidity.
11. Place the device on a solid surface during installation to prevent falls.
12. Do not cover the openings on the device to ensure optimal heat dissipation.
13. Watch out for high temperatures when the system is running.
14. Do not touch the heat sink or heat spreader when the system is running
15. Never pour any liquid into the openings. This could cause fire or electric shock.
16. As most electronic components are sensitive to static electrical charge, be sure to ground yourself to prevent static charge when installing the internal components. Use a grounding wrist strap and contain all electronic components in any static-shielded containers.

17. If any of the following situations arises, please contact our service personnel:
 - i. Damaged power cord or plug
 - ii. Liquid intrusion to the device
 - iii. Exposure to moisture
 - iv. Device is not working as expected or in a manner as described in this manual
 - v. The device is dropped or damaged
 - vi. Any obvious signs of damage displayed on the device
18. Do not leave this device in an uncontrolled environment with temperatures beyond the device's permitted storage temperatures (see chapter 1) to prevent damage.
19. Do NOT disassemble the motherboard so as not to damage the system or void your warranty.
20. If the thermal pad had been damaged, please contact AAEON's salesperson to purchase a new one. Do NOT use those of other brands.
21. The Hex Cylinder Coppers on the front panel are not removable.
22. Repeatedly assemble and disassemble the system may cause damages to the exterior paint and surface and screw holes.
23. Use the right size screwdriver.
24. Use the screwdriver correctly to remove screws from the system.

FCC Statement

Warning!



This device complies with Part 15 FCC Rules. Operation is subject to the following two conditions: (1) this device may not cause harmful interference, and (2) this device must accept any interference received including interference that may cause undesired operation.

Caution:

There is a danger of explosion if the battery is incorrectly replaced. Replace only with the same or equivalent type recommended by the manufacturer. Dispose of used batteries according to the manufacturer's instructions and your local government's recycling or disposal directives.

Attention:

Il y a un risque d'explosion si la batterie est remplacée de façon incorrecte. Ne la remplacer qu'avec le même modèle ou équivalent recommandé par le constructeur. Recycler les batteries usées en accord avec les instructions du fabricant et les directives gouvernementales de recyclage.

China RoHS Requirements (CN)

产品中有毒有害物质或元素名称及含量

AAEON Embedded Box PC/ Industrial System

部件名称	有毒有害物质或元素					
	铅 (Pb)	汞 (Hg)	镉 (Cd)	六价铬 (Cr(VI))	多溴联苯 (PBB)	多溴二苯醚 (PBDE)
印刷电路板 及其电子组件	○	○	○	○	○	○
外部信号 连接器及线材	○	○	○	○	○	○
外壳	○	○	○	○	○	○
中央处理器 与内存	○	○	○	○	○	○
硬盘	○	○	○	○	○	○
电源	○	○	○	○	○	○

○: 表示该有毒有害物质在该部件所有均质材料中的含量均在 SJ/T 11363-2006 标准规定的限量要求以下。

X: 表示该有毒有害物质至少在该部件的某一均质材料中的含量超出 SJ/T 11363-2006 标准规定的限量要求。

备注:
一、此产品所标示之环保使用期限, 系指在一般正常使用状况下。
二、上述部件物质中央处理器、内存、硬盘、电源为选购品。

China RoHS Requirement (EN)

Poisonous or Hazardous Substances or Elements in Products
 AAEON Embedded Box PC/ Industrial System

Component	Poisonous or Hazardous Substances or Elements					
	Lead (Pb)	Mercury (Hg)	Cadmium (Cd)	Hexavalent Chromium (Cr(VI))	Polybrominated Biphenyls (PBB)	Polybrominated Diphenyl Ethers (PBDE)
PCB & Other Components	○	○	○	○	○	○
Wires & Connectors for External Connections	○	○	○	○	○	○
Chassis	○	○	○	○	○	○
CPU & RAM	○	○	○	○	○	○
Hard Disk	○	○	○	○	○	○
PSU	○	○	○	○	○	○

O: The quantity of poisonous or hazardous substances or elements found in each of the component's parts is below the SJ/T 11363-2006-stipulated requirement.

X: The quantity of poisonous or hazardous substances or elements found in at least one of the component's parts is beyond the SJ/T 11363-2006-stipulated requirement.

Note: The Environment Friendly Use Period as labeled on this product is applicable under normal usage only

Table of Contents

Chapter 1 - Product Specifications	1
1.1 Specifications.....	2
Chapter 2 – Hardware Information	4
2.1 Dimensions	5
2.2 Jumpers and Connectors	6
2.3 Block Diagram.....	7
2.4 List of Jumpers	8
2.4.1 Clear CMOS Jumper (JP1)	8
2.4.2 LVDS Power & Backlight Power Selection (JP2)	8
2.4.3 LVDS BKLT Control Selection (JP4)	9
2.4.4 Touch Screen Lines 4, 5, 8 Wire Selection (JP5)	9
2.4.5 COM5 RI Voltage selection (JP7)	9
2.4.6 COM6 RI Voltage selection (JP8)	9
2.4.7 Front Panel (JP11).....	10
2.5 List of Connectors	11
2.5.1 RTC Battery (CN1)	13
2.5.2 External Power Input (CN2)	13
2.5.3 UIM Card Socket (Push-Push type) (CN13)	13
2.5.4 SATA Port (CN14).....	14
2.5.5 SATA Power Connector.....	15
2.5.6 Mini-Card Slot (Half-Mini-Card) (CN37)	16
2.5.7 Mini-Card Slot (Full-Mini-Card) (CN16).....	19
2.5.8 LAN1/USB3x2 (CN40).....	21
2.5.9 LAN2/USB3x2 (CN41).....	22
2.5.10 VGA\HDMI Port (CN53)	24
2.5.11 COM Port1/2	25

2.5.12	COM Port3/4	26
2.5.13	COM Port5/6	27
2.6	Hard Disk Drive Installation	30
2.7	RAM Installation	33
2.8	Mini_Card Installation	35
2.9	Wallmount Installation	37
Chapter 3 - AMI BIOS Setup		38
3.1	System Test and Initialization	39
3.2	AMI BIOS Setup	40
3.3	Setup Submenu: Main	41
3.4	Setup Submenu: Advanced	42
3.4.1	Advanced: Trusted Computing	43
3.4.2	Advanced: CPU Configuration	44
3.4.3	Advanced: SATA Drives	46
3.4.4	Advanced: Hardware Monitor	47
3.4.5	Advanced: SIO Configuration	48
3.4.5.1	SIO Configuration: Serial Port 1 Configuration	49
3.4.5.2	SIO Configuration: Serial Port 2 Configuration	50
3.4.5.3	SIO Configuration: Serial Port 3 Configuration	51
3.4.5.4	SIO Configuration: Serial Port 4 Configuration	52
3.4.5.5	SIO Configuration: Serial Port 5 Configuration	53
3.4.5.6	SIO Configuration: Serial Port 6 Configuration	54
3.4.6	Advanced: Power Management	55
3.4.7	Advanced: Dynamic Digital IO Configuration	56
3.5	Setup submenu: Chipset	57
3.5.1	Chipset: North Bridge	58
3.5.2	Chipset: South Bridge	59
3.6	Setup submenu: Security	60

3.7	Setup submenu: Boot.....	62
3.8	Setup submenu: Save & Exit.....	63
Chapter 4 – Drivers Installation		64
4.1	Product CD/DVD.....	65
Appendix A – Watchdog Timer Programming.....		67
A.1	Watchdog Timer Initial Program.....	68
Appendix B – I/O Information		73
B.1	I/O Address Map.....	74
B.2	Memory Address Map.....	77
B.3	IRQ Mapping Chart	79
Appendix C – Digital I/O Ports		88
C.1	Electrical Specifications for Digital I/O Ports	89
C.2	DIO Programming	90
C.3	Digital I/O Register.....	91
C.4	Digital I/O Sample Program.....	92

Chapter 1

Product Specifications

1.1 Specifications

System

- **Processor** Intel (R) Pentium(R) N4200 2.5GHz or Celeron(R) N3350 2.4GHz
- **Chipset** Intel® System on Chip
- **System Memory** 204-pin 1866 DDR3L SODIMM x 1, up to 8GB
- **Display Interface** VGA x 1
HDMI x 1
- **Storage Device** mSATA, 2.5" HDD/SSD
- **Ethernet** Intel (R), 10/100/1000Base x2
- **I/O** RS-232/422/485 x 2
RS-232 x 4
USB3.0 x 4
VGA x 1
HDMI x 1
DIO x 1 (Optional)
Mic-in x 1
Line-Out x 1
Antenna holes x 2
Power Button x 1
AT/ATX Switch x 1
Remote Power On/Off Connector x 1
9~24C Wire Range DC-Input
- **Expansion Slot** Full-size Mini-Card x 1
Half-size Mini-Card x 1 (optional for mSATA)

- **Indicator** Power LED x 1
HDD Active LED x 1
- **OS Support** Windows® 10
Win10 IOT
Linux

Mechanical

- **Mounting** Wallmount
DIN Rail (optional)
- **Dimension (W x H x D)** 197mm x 111mm x 61.2mm
- **Gross Weight** 2.8 kg (6.6 lb)
- **Net Weight** 2 kg (4.4 lb)

Environmental

- **Operating Temperature** -20°C ~ 70°C with W.T. SSD/HDD/mSATA
(according to IEC682-14 with 0.5 m/s AirFlow ;
with industrial devices)
- **Storage Temperature** -20°C ~ 70°C (-4°F ~ 158°F)
- **Storage Humidity** 95% @ 40°C, non-condensing
- **Anti-Vibration** 5 G_{rms} / 5~500Hz/ operation – mSATA/SSD
1 G_{rms} / 5~500Hz/ operation – HDD
- **EMC** CE/FCC Class A

Power Supply

- **DC Input** 9 - 24V with 3-pin terminal block

Chapter 2

Hardware Information

2.1 Dimensions

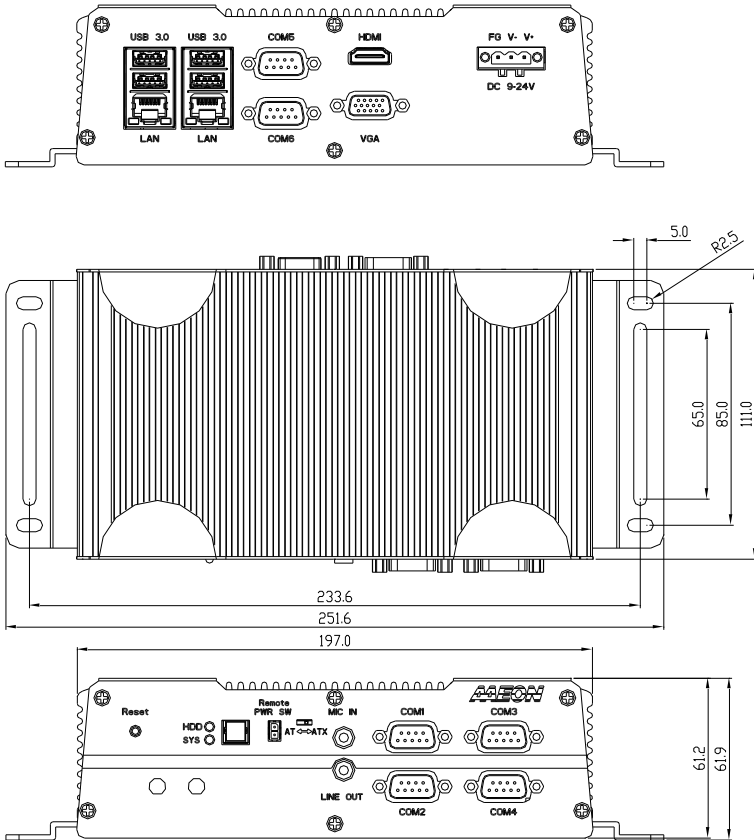

2.2 Jumpers and Connectors

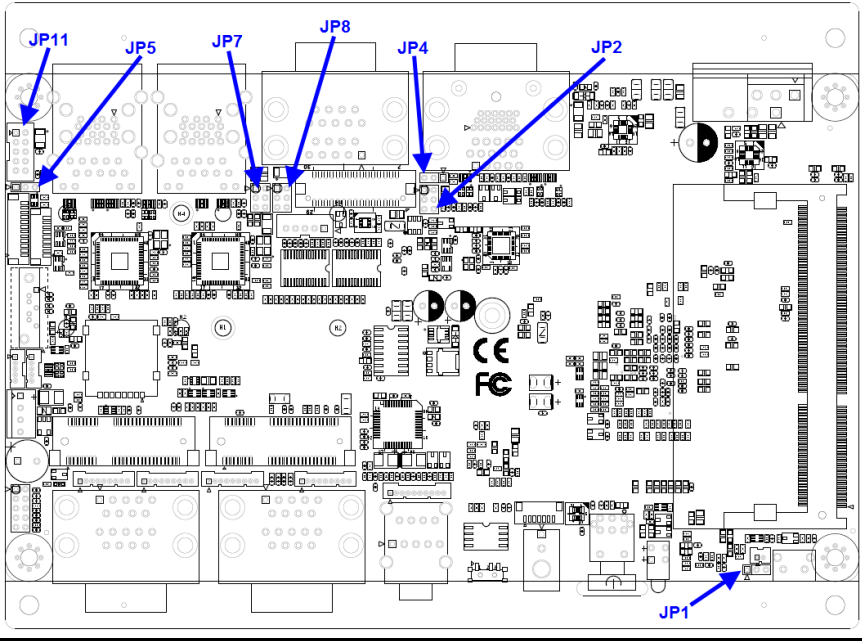

2.3 Block Diagram

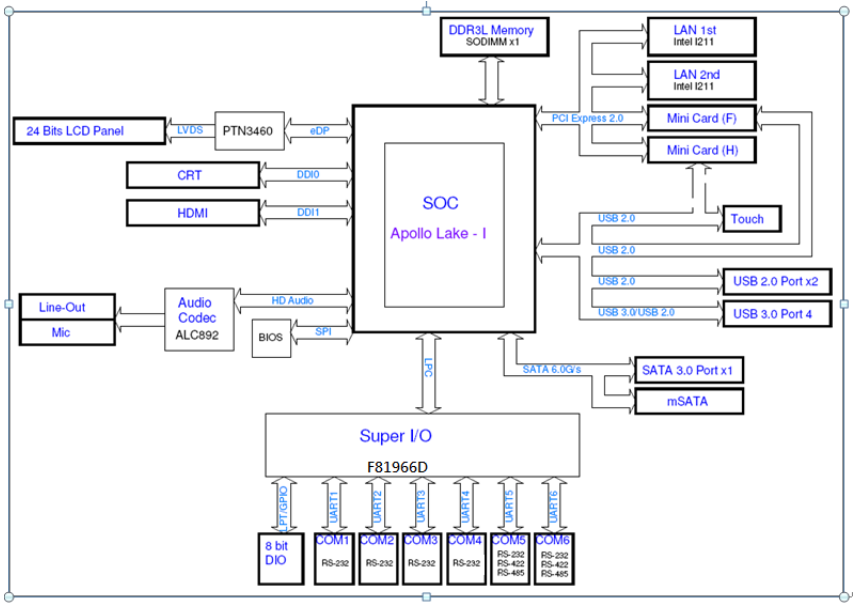

2.4 List of Jumpers

Please refer to the table below for all of the system's jumpers that you can configure for your application.

Label	Function
JP1	Clear CMOS Jumper
JP2	LVDS Power & Backlight Power Selection
JP4	LVDS Backlight Control Selection
JP5	Touch Screen Lines 4,5,8 Wire Selection
JP7	COM5 RI Voltage selection
JP8	COM6 RI Voltage selection
JP11	Front Panel

2.4.1 Clear CMOS Jumper (JP1)

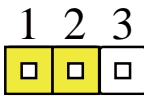

Normal (Default)

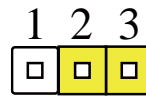

Clear CMOS

2.4.2 LVDS Power & Backlight Power Selection (JP2)

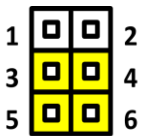

LVDS BKLT +5V

LVDS Power +3.3V

(Default)

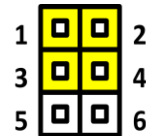

+12V

+5V

2.4.3 LVDS BKLT Control Selection (JP4)

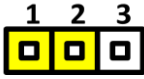

VR Mode(Default)



PWM Mode

2.4.4 Touch Screen Lines 4, 5, 8 Wire Selection (JP5)



4, 8 wire (Default)

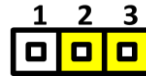

5 wire

2.4.5 COM5 RI Voltage selection (JP7)

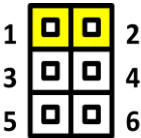

+12V

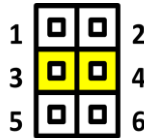

Ring (Default)

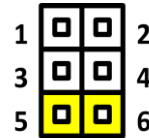

+5V

2.4.6 COM6 RI Voltage selection (JP8)

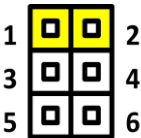

+12V

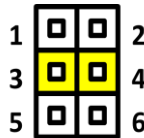

Ring (Default)

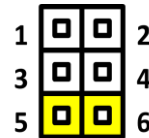

+5V

2.4.7 Front Panel (JP11)

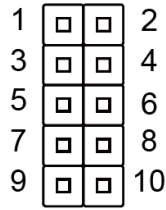

Pin	Function
1	GND
2	EXT_PWRBTN#
3	FP_HDLED-
4	FP_HDLED+
5	FP_SPKR-
6	+V5S
7	GND
8	PWRLED+
9	GND
10	HWRST#

2.5 List of Connectors

Please refer to the table below for all of the system's connectors that you can configure for your application

Label	Function
CN1	RTC Battery
CN2	External Power Input
CN5	LVDS Backlight
CN6	LVDS
CN13	UIM Card push-push (Optional)
CN14	SATA HDD
CN15	+5V/+12V Output for SATA HDD
CN16	Mini-Card Slot (Full-Mini-Card)
CN18	Audio Line-out/MIC
CN20	USB 2.0 x 1
CN21	USB 2.0 x 1
CN22	Touch Panel
CN23	BIOS Debug Port
CN24	LPC Port
CN37	Mini-Card Slot (Half-Mini-Card)2
CN40	LAN1/USB3 x 2
CN41	LAN2/USB3 x 2
CN43	Digital IO Port
CN44	Remote Power on/off Switch
CN53	HDMI/VGA Port
DIMM1	DDR3L SO-DIMM Slot
COM1/COM2	COM Port 1/2
COM3/COM4	COM Port 3/4

Label	Function
COM5/COM6	COM Port 5/6

2.5.1 RTC Battery (CN1)

Pin	Pin Name	Signal Type	Signal Level
1	+V3.3A_RTC	PWR	+3.3V
2	GND	GND	

2.5.2 External Power Input (CN2)

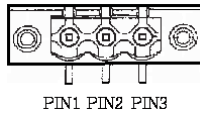

Pin	Pin Name	Signal Type	Signal Level
1	PWR_IN	PWR	+9V~+24V
2	GND	GND	
3	NC	NC	

2.5.3 UIM Card Socket (Push-Push type) (CN13)

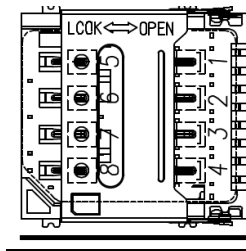

Pin	Pin Name	Signal Type	Signal Level
1	UIM_PWR	PWR	
2	UIM_RST	IN	
3	UIM_CLK	IN	
4	NC		
5	GND	GND	
6	UIM_VPP	PWR	
7	UIM_DATA	I/O	
8	NC		

2.5.4 SATA Port (CN14)

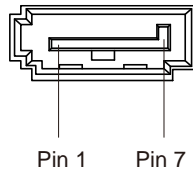

Pin	Pin Name	Signal Type	Signal Level
1	GND	GND	
2	SATA_TXP0	DIFF	
3	SATA_TXN0	DIFF	
4	GND	GND	
5	SATA_RXN0	DIFF	
6	SATA_RXP0	DIFF	
7	GND	GND	

2.5.5 SATA Power Connector

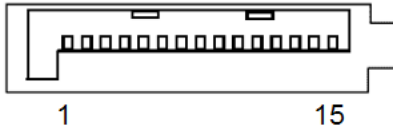

Pin	Signal	Pin	Signal
1	+3.3VDC	2	+3.3VDC
3	+3.3VDC	4	COM
5	COM	6	COM
7	+5VDC	8	+5VDC
9	+5VDC	10	COM
11	COM	12	COM
13	+12VDC	14	+12VDC
15	+12VDC		

2.5.6 Mini-Card Slot (Half-Mini-Card) (CN37)

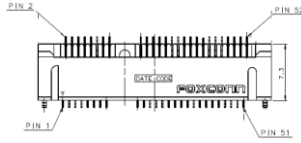

Pin	Pin Name	Signal Type	Signal Level
1	PCIE_WAKE3_MP2_N_3P3	IN	
2	+V3.3_MINICARD_MSATA	PWR	+3.3V
3	NC		
4	GND	GND	
5	NC		
6	+V1.5S	PWR	+1.5V
7	MPCIE2_CLKREQ#		
8	NC		
9	GND	GND	
10	NC	I/O	
11	CLK_PCIE_MPCIE2_N	DIFF	
12	NC	IN	
13	CLK_PCIE_MPCIE2_P	DIFF	
14	NC		
15	GND	GND	
16	NC	PWR	

Pin	Pin Name	Signal Type	Signal Level
17	NC		
18	GND	GND	
19	NC		
20	W_DISABLE1#	OUT	+3.3V
21	GND	GND	
22	BUF_PLT_RST#	OUT	+3.3V
23	PCIE_RXN3_R	DIFF	
24	+V3.3_MINICARD_MSATA	PWR	+3.3V
25	PCIE_RXP3_R	DIFF	
26	GND	GND	
27	GND	GND	
28	+V1.5S	PWR	+1.5V
29	GND	GND	
30	SMB_CLK_A	I/O	+3.3V
31	PCIE_TXN3_R	DIFF	
32	SMB_DATA_A	I/O	+3.3V
33	PCIE_TXP3_R	DIFF	
34	GND	GND	
35	GND	GND	
36	USB_DN7_MPCIE	DIFF	
37	GND	GND	

Pin	Pin Name	Signal Type	Signal Level
38	USB_DP7_MPCIE	DIFF	
39	+V3.3_MINICARD_MSATA	PWR	+3.3V
40	GND	GND	
41	+V3.3_MINICARD_MSATA	PWR	+3.3V
42	NC		
43	GND	GND	
44	NC		
45	NC		
46	NC		
47	NC		
48	+V1.5S	PWR	+1.5V
49	NC		
50	GND	GND	
51	NC		
52	+V3.3_MINICARD_MSATA	PWR	+3.3V

2.5.7 Mini-Card Slot (Full-Mini-Card) (CN16)

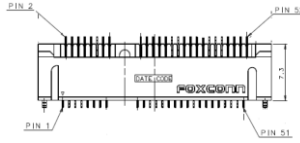

Pin	Pin name	Signal Type	Signal Level
1	PCIE_WAKE2_MP1_N_3P3	IN	
2	+V3.3A	PWR	+3.3V
3	NC		
4	GND	GND	
5	NC		
6	+V1.5S	PWR	+1.5V
7	MPCIE1_CLKREQ#		
8	UIM_PWR		
9	GND	GND	
10	UIM_DAT	I/O	
11	CLK_PCIE_MPCIE1_N	DIFF	
12	UIM_CLK	IN	
13	CLK_PCIE_MPCIE1_P	DIFF	
14	UIM_RST		
15	GND	GND	
16	UIM_VPP	PWR	
17	NC		
18	GND	GND	
19	NC		
20	W_DISABLE0#	OUT	+3.3V
21	GND	GND	

Pin	Pin name	Signal Type	Signal Level
22	BUF_PLT_RST#	OUT	+3.3V
23	PCIE_RXN2	DIFF	
24	+V3.3A	PWR	+3.3V
25	PCIE_RXP2	DIFF	
26	GND	GND	
27	GND	GND	
28	+V1.5S	PWR	+1.5V
29	GND	GND	
30	SMB_CLK_A	I/O	+3.3V
31	PCIE_TXN2	DIFF	
32	SMB_DATA_A	I/O	+3.3V
33	PCIE_TXP2	DIFF	
34	GND	GND	
35	GND	GND	
36	USB_DN6	DIFF	
37	GND	GND	
38	USB_DP6	DIFF	
39	+V3.3A	PWR	+3.3V
40	GND	GND	
41	+V3.3A	PWR	+3.3V
42	NC		
43	GND	GND	
44	NC		
45	NC		
46	NC		
47	NC		
48	+V1.5S	PWR	+1.5V

Pin	Pin name	Signal Type	Signal Level
49	NC		
50	GND	GND	
51	NC		
52	+V3.3A	PWR	+3.3V

2.5.8 LAN1/USB3x2 (CN40)

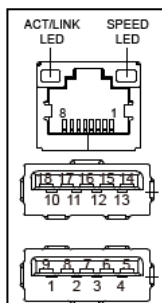

Pin	Pin name	Signal Type	Signal Level
1	LAN1_MDI0P	DIFF	
2	LAN1_MDI0N	DIFF	
3	LAN1_MDI1P	DIFF	
4	LAN1_MDI1N	DIFF	
5	LAN1_MDI2P	DIFF	
6	LAN1_MDI2N	DIFF	
7	LAN1_MDI3P	DIFF	
8	LAN1_MDI3N	DIFF	
U1	+V5A_USB_0	PWR	+5V
U2	USB0-	DIFF	
U3	USB0+	DIFF	
U4	GND	GND	

U5	USB3_RX0_CON_N	DIFF	
U6	USB3_RX0_CON_P	DIFF	
U7	GND	GND	
U8	USB3_TX0_CON_N	DIFF	
U9	USB3_TX0_CON_P	DIFF	
U10	+V5A_USB_1	PWR	+5V
U11	USBD1-	DIFF	
U12	USBD1+	DIFF	
U13	GND	GND	
U14	USB3_RX1_CON_N	DIFF	
U15	USB3_RX1_CON_P	DIFF	
U16	GND	GND	
U17	USB3_TX1_CON_N	DIFF	
U18	USB3_TX1_CON_P	DIFF	

2.5.9 LAN2/USB3x2 (CN41)

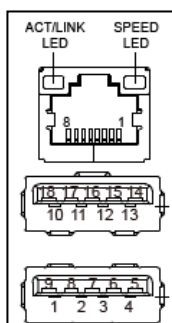

Pin	Pin name	Signal Type	Signal Level
1	LAN2_MDI0P	DIFF	
2	LAN2_MDI0N	DIFF	

3	LAN2_MDI1P	DIFF	
4	LAN2_MDI1N	DIFF	
5	LAN2_MDI2P	DIFF	
6	LAN2_MDI2N	DIFF	
7	LAN2_MDI3P	DIFF	
8	LAN2_MDI3N	DIFF	
U1	+V5A_USB_2	PWR	+5V
U2	USBD2-	DIFF	
U3	USBD2+	DIFF	
U4	GND	GND	
U5	USB3_RX2_CON_N	DIFF	
U6	USB3_RX2_CON_P	DIFF	
U7	GND	GND	
U8	USB3_TX2_CON_N	DIFF	
U9	USB3_TX2_CON_P	DIFF	
U10	+V5A_USB_3	PWR	+5V
U11	USBD3-	DIFF	
U12	USBD3+	DIFF	
U13	GND	GND	
U14	USB3_RX3_CON_N	DIFF	
U15	USB3_RX3_CON_P	DIFF	
U16	GND	GND	
U17	USB3_TX3_CON_N	DIFF	
U18	USB3_TX3_CON_P	DIFF	

2.5.10VGA\HDMI Port (CN53)

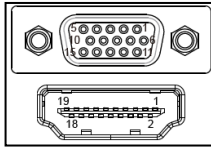

Pin	Pin name	Signal Type	Signal Level
A1	RED	OUT	
A2	GREEN	OUT	
A3	BLUE	OUT	
A4	NC		
A5	GND	GND	
A6	GND	GND	
A7	GND		
A8	GND	GND	
A9	+V5S_DISP	PWR	+5V
A10	CRT_PLUG		
A11	NC		
A12	VGA_DDCDATA	I/O	+5V
A13	HSYNC	OUT	
A14	VSYNC	OUT	
A15	VGA_DDCCLK	I/O	+5V
1	HDMI_DATA2_P	DIFF	
2	GND	GND	
3	HDMI_DATA2_N	DIFF	
4	HDMI_DATA1_P	DIFF	
5	GND	GND	

6	HDMI_DATA1_N	DIFF	
7	HDMI_DATA0_P	DIFF	
8	GND	GND	
9	HDMI_DATA0_N	DIFF	
10	HDMI_CLK_C_P	DIFF	
11	GND	GND	
12	HDMI_CLK_C_N	DIFF	
13	NC		
14	NC		
15	HDMI_SCL	I/O	+5V
16	HDMI_SDA	I/O	+5V
17	GND	GND	
18	+V5S_HDMI_CON	I/O	+5V
19	HDMI_HPD	IN	

2.5.11 COM Port1/2

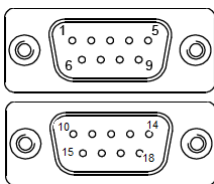

Pin	Pin name	Signal Type	Signal Level
1	DCD1	IN	
2	RX1	IN	
3	TX1	OUT	±9V
4	DTR1	OUT	±9V

5	GND	GND	
6	DSR1	IN	
7	RTS1	OUT	±9V
8	CTS1	IN	
9	RI1	IN	
10	DCD2	IN	
11	RX2	IN	
12	TX2	OUT	±9V
13	DTR2	OUT	±9V
14	GND	GND	
15	DSR2	IN	
16	RTS2	OUT	±9V
17	CTS2	IN	
18	RI2	IN	

2.5.12 COM Port3/4

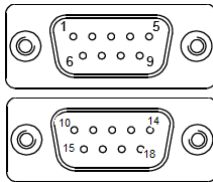

Pin	Pin name	Signal Type	Signal Level
1	DCD3	IN	
2	RX3	IN	
3	TX3	OUT	±9V
4	DTR3	OUT	±9V

5	GND	GND	
6	DSR3	IN	
7	RTS3	OUT	±9V
8	CTS3	IN	
9	RI3	IN	
10	DCD4	IN	
11	RX4	IN	
12	TX4	OUT	±9V
13	DTR4	OUT	±9V
14	GND	GND	
15	DSR4	IN	
16	RTS4	OUT	±9V
17	CTS4	IN	
18	RI4	IN	

2.5.13 COM Port5/6

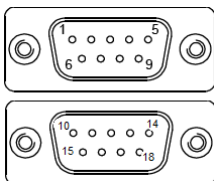

RS232

Pin	Pin name	Signal Type	Signal Level
1	DCD5	IN	
2	RX5	IN	
3	TX5	OUT	±9V
4	DTR5	OUT	±9V
5	GND	GND	

6	DSR5	IN	
7	RTS5	OUT	±9V
8	CTS5	IN	
9	RI5	IN	
10	DCD6	IN	
11	RX6	IN	
12	TX6	OUT	±9V
13	DTR6	OUT	±9V
14	GND	GND	
15	DSR6	IN	
16	RTS6	OUT	±9V
17	CTS6	IN	
18	RI6	IN	

RS485

Pin	Pin name	Signal Type	Signal Level
1	RS485_D6-	I/O	±5V
2	RS485_D6+	I/O	±5V
3	NC		
4	NC		
5	GND	GND	
6	NC		
7	NC		
8	NC		
9	NC/5V/12V		
10	RS485_D5-	I/O	±5V
11	RS485_D5+	I/O	±5V
12	NC		

13	NC	
14	GND	GND
15	NC	
16	NC	
17	NC	
18	NC/5V/12V	

RS422

Pin	Pin name	Signal Type	Signal Level
1	RS422_TX6-	OUT	±5V
2	RS422_TX6+	OUT	±5V
3	RS422_RX6+	IN	
4	RS422_RX6-	IN	
5	GND	GND	
6	NC		
7	NC		
8	NC		
9	NC/5V/12V		
10	RS422_TX5-	OUT	±5V
11	RS422_TX5+	OUT	±5V
12	RS422_RX5+	IN	
13	RS422_RX5-	IN	
14	GND	GND	
15	NC		
16	NC		
17	NC		
18	NC/5V/12V		

2.6 Hard Disk Drive Installation

Step 1: Remove the baseplate as instructed below

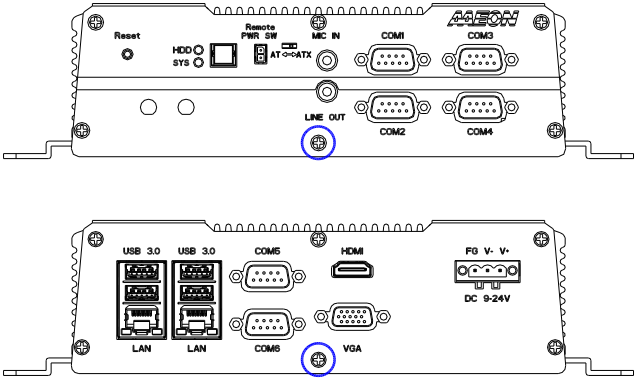

Step 2: Place the HDD on the bracket plate

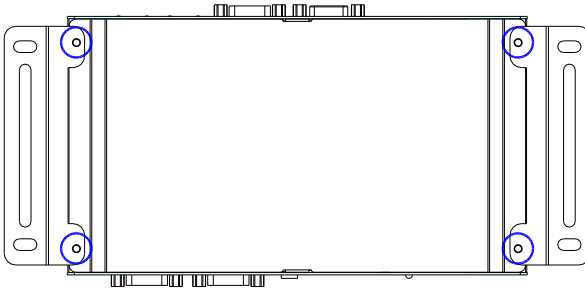

Step 3: Tighten the screws at the back to secure the HDD

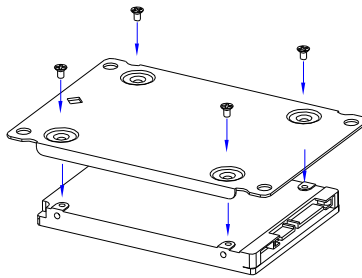

Step 4: Connect the SATA and power cables to the HDD, attach the HDD assembly to the baseplate.

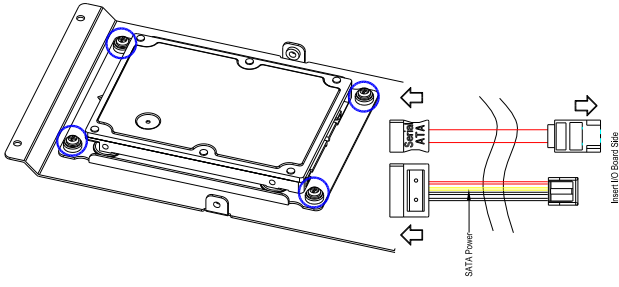

2.7 RAM Installation

Step 1: Remove the baseplate as instructed below

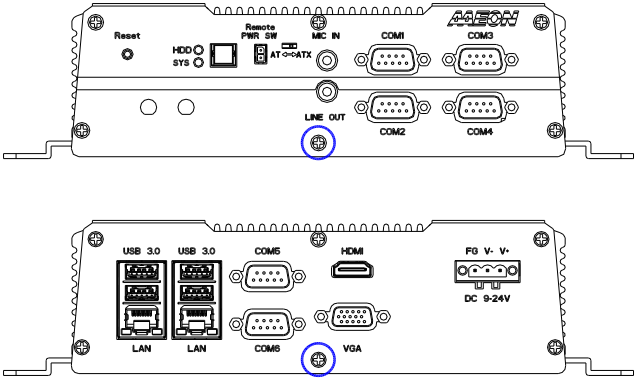

Step 2: Insert the RAM into the RAM slot

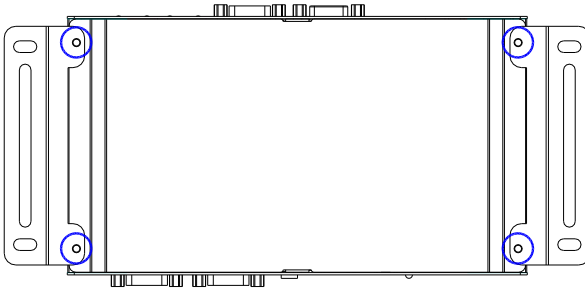

Step 3: Push down to secure the RAM

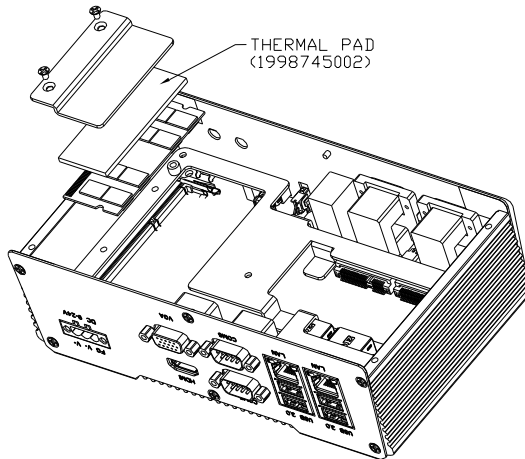

2.8 Mini_Card Installation

Step 1: Remove the baseplate as instructed below

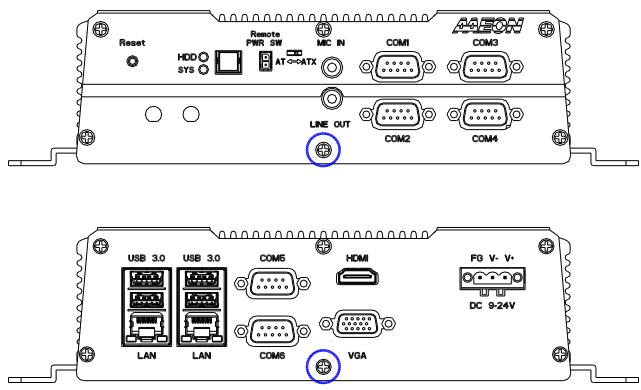

Step 2: Insert the Mini-Card into the Mini-Card slot

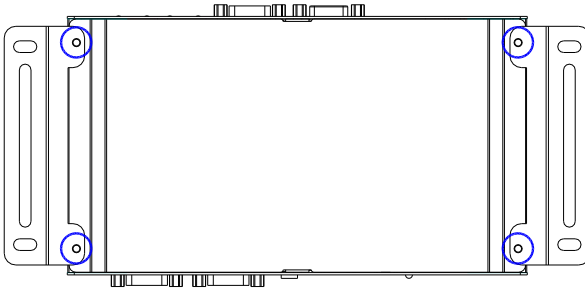

Step 3: Push down to secure the Mini-Card

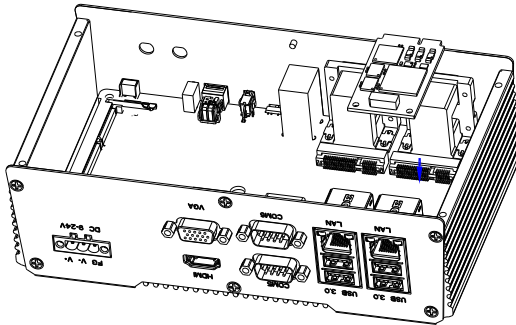

2.9 Wallmount Installation

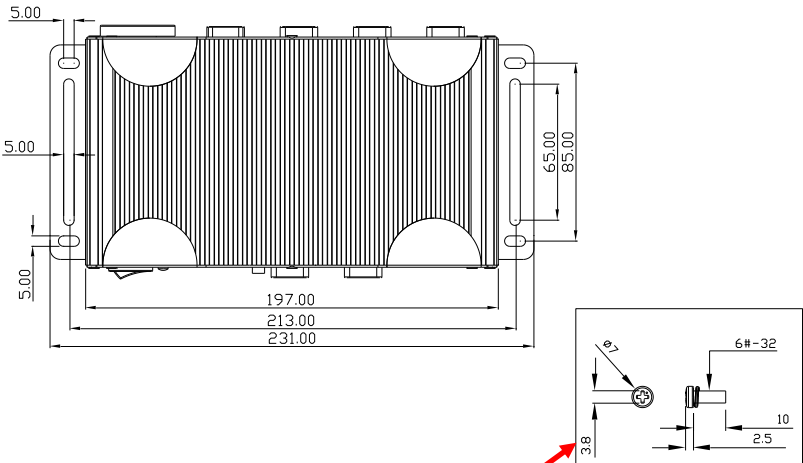
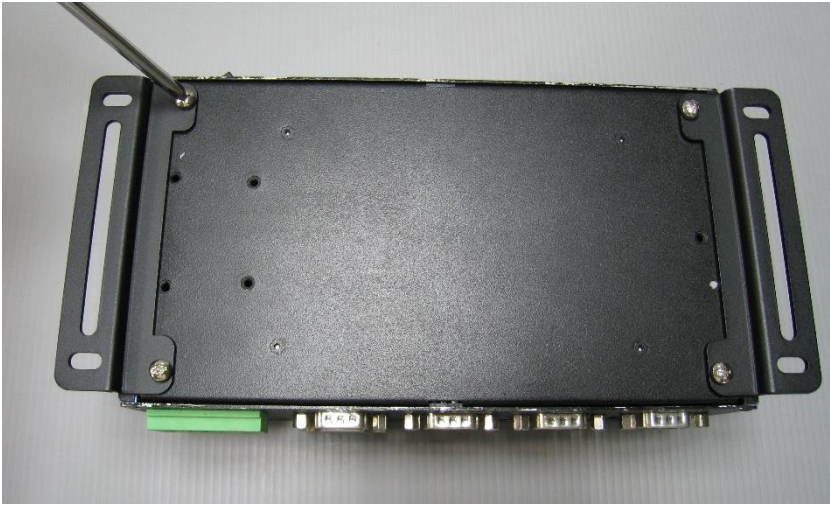

We suggest using this screw.

Chapter 3

AMI BIOS Setup

3.1 System Test and Initialization

The system uses certain routines to perform testing and initialization. If an error, fatal or non-fatal, is encountered, a few short beeps or an error message will be outputted. The board can usually continue the boot up sequence with non-fatal errors.

The system configuration verification routines check the current system configuration against the values stored in the CMOS memory. If they do not match, an error message will be outputted, in which case you will need to run the BIOS setup program to set the configuration information in memory.

There are three situations in which you will need to change the CMOS settings:

- You are starting your system for the first time
- You have changed your system's hardware
- The CMOS memory has lost power and the configuration information is erased

The system's CMOS memory uses a backup battery for data retention, which is to be replaced once emptied.

3.2 AMI BIOS Setup

The AMI BIOS ROM has a pre-installed Setup program that allows users to modify basic system configurations, which is stored in the battery-backed CMOS RAM and BIOS NVRAM so that the information is retained when the power is turned off.

To enter BIOS Setup, press immediately while your computer is powering up.

The function for each interface can be found below.

Main – Date and time can be set here. Press <Tab> to switch between date elements

Advanced – Enable/ Disable boot option for legacy network devices

Chipset – For hosting bridge parameters

Boot – Enable/ Disable quiet Boot Option

Security – The setup administrator password can be set here

Save & Exit – Save your changes and exit the program

3.3 Setup Submenu: Main

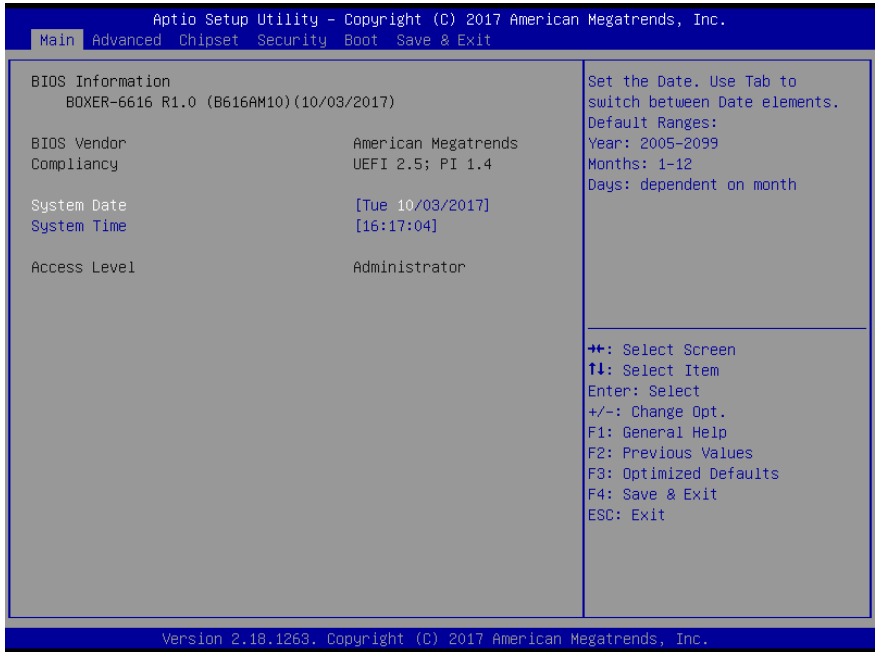

3.4 Setup Submenu: Advanced

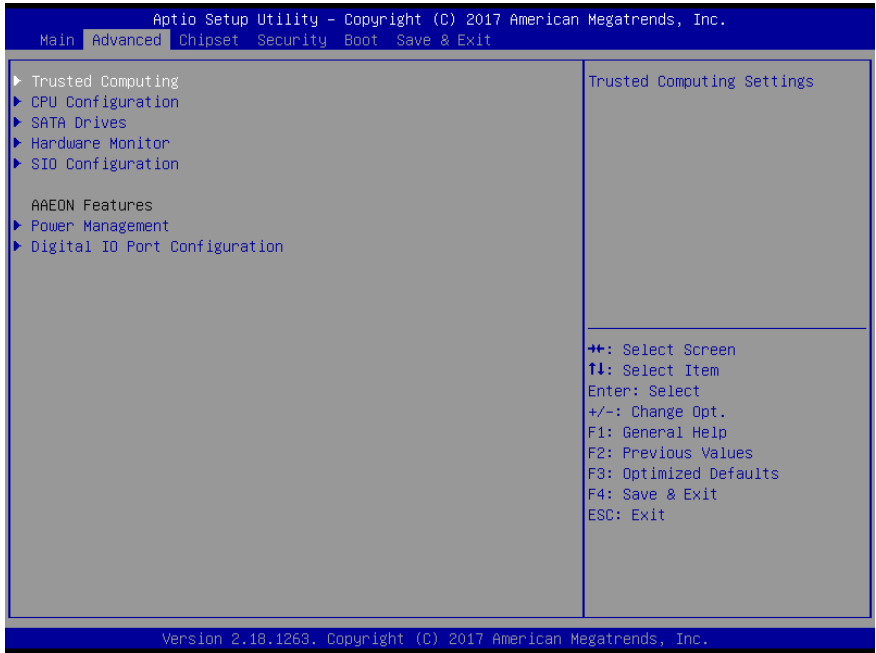

3.4.1 Advanced: Trusted Computing

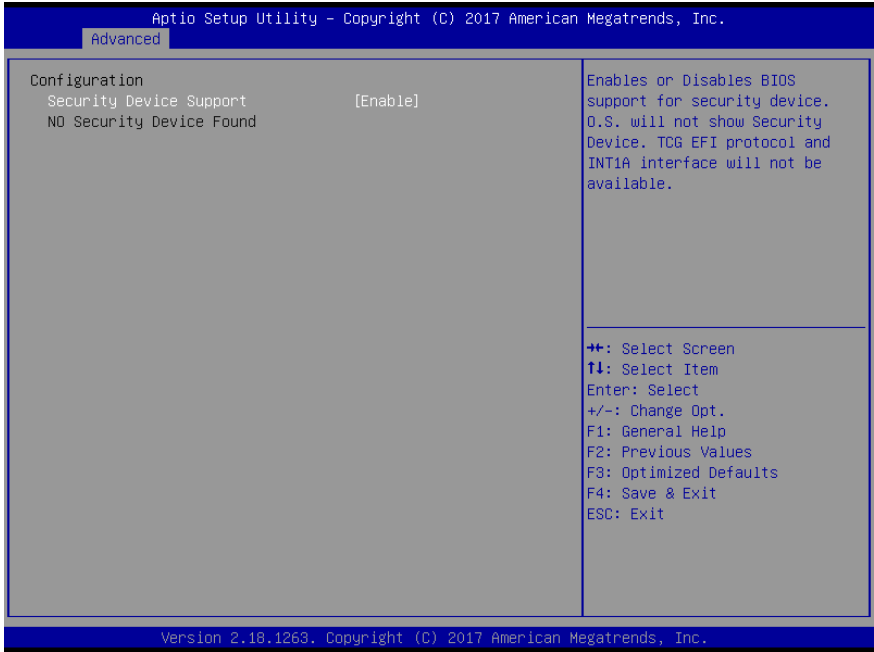

Options summary:

Security Device	Disable	Optimal Default, Failsafe Default
Support	Enable	
Enables or Disables BIOS support for security device. O.S. will not show Security Device. TCG EFI protocol and INT1A interface will not be available.		

3.4.2 Advanced: CPU Configuration

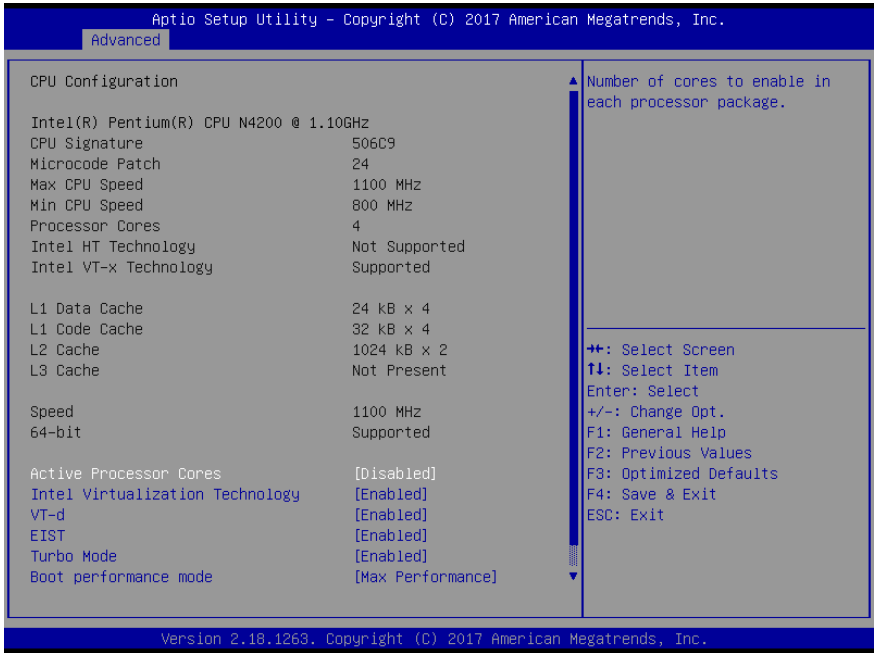

Options summary:

Active Processor Cores	Disabled	Optimal Default, Failsafe Default
	Enabled	
Number of cores to enable in each processor package		
Intel Virtualization Technology	Disabled	
	Enabled	Optimal Default, Failsafe Default
When enabled, a VMM can utilize the additional hardware capabilities provided by Vanderpool Technology.		
VT-d	Disabled	
	Enabled	Optimal Default, Failsafe Default
Enable/Disable CPU VT-d		
EIST	Disabled	
	Enabled	Optimal Default, Failsafe Default
Enable/Disable Intel SpeedStep		
Turbo Mode	Disabled	
	Enabled	Optimal Default, Failsafe Default
Turbo Mode		

Boot performance mode	Max performance	Optimal Default, Failsafe Default
	Max battery	
Select the performance state that the BIOS will set before OS handoff		
Power Limit 1 Enable	Disabled	Optimal Default, Failsafe Default
	Enabled	
Enable/Disable Power Limit 1		
C-states	Disabled	Optimal Default, Failsafe Default
	Enabled	
Enable/Disable C states		

3.4.3 Advanced: SATA Drives

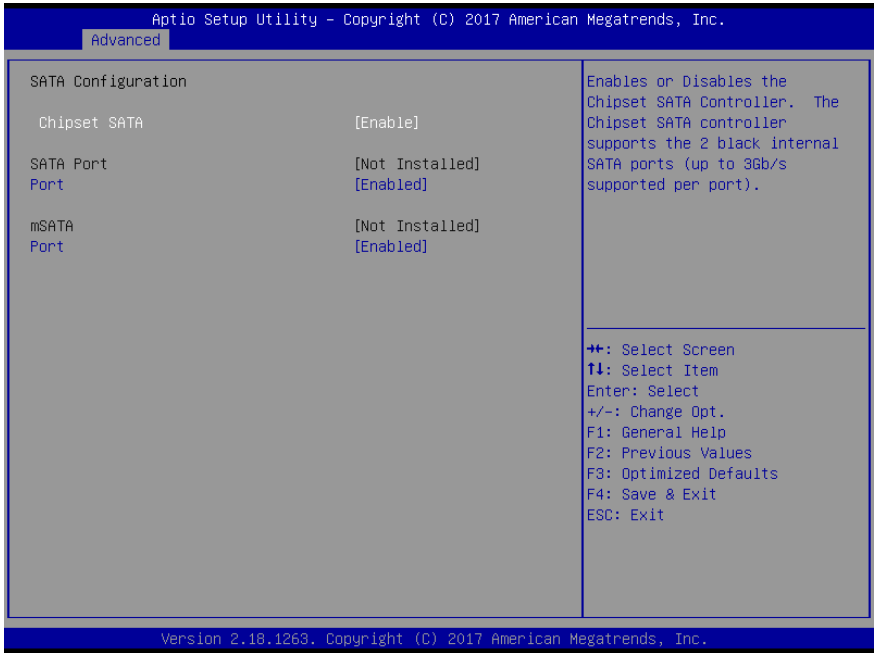

Options summary:

Chipset SATA	Enable	Optimal Default, Failsafe Default
	Disable	
Enable or Disable the Chipset SATA Controller. The Chipset SATA controller supports the 2 black internal SATA ports (up to 3Gb/s supported per port)		
Port	Enable	Optimal Default, Failsafe Default
	Disable	
Enable or Disable SATA Port		
Port	Enable	Optimal Default, Failsafe Default
	Disable	
Enable or Disable SATA Port		

3.4.4 Advanced: Hardware Monitor

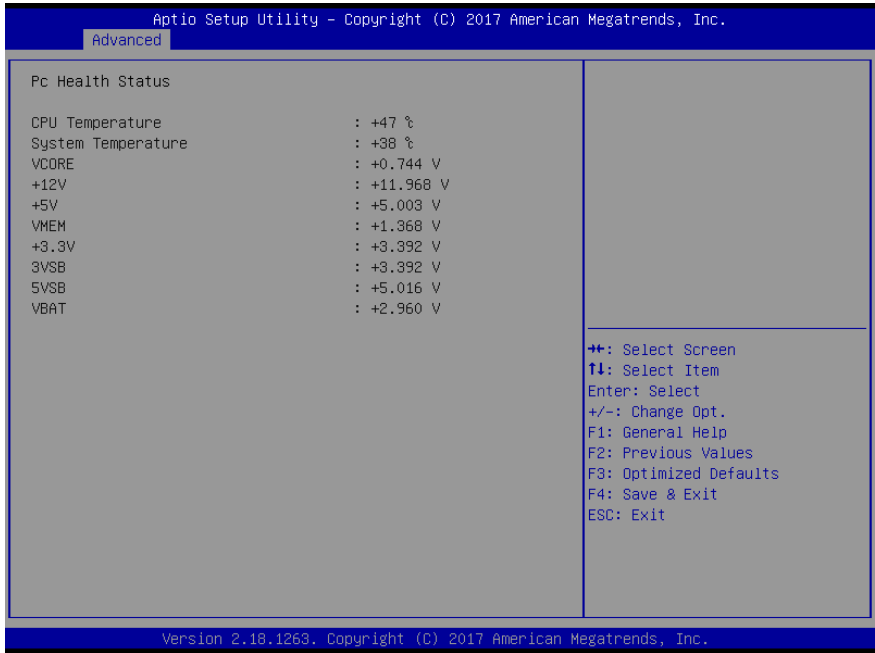

3.4.5 Advanced: SIO Configuration

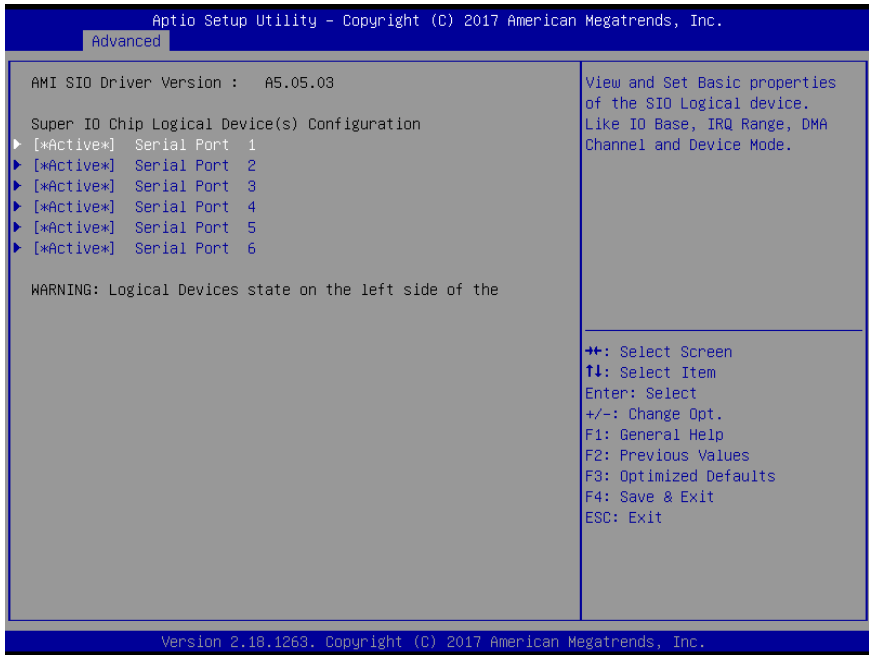

3.4.5.1 SIO Configuration: Serial Port 1 Configuration

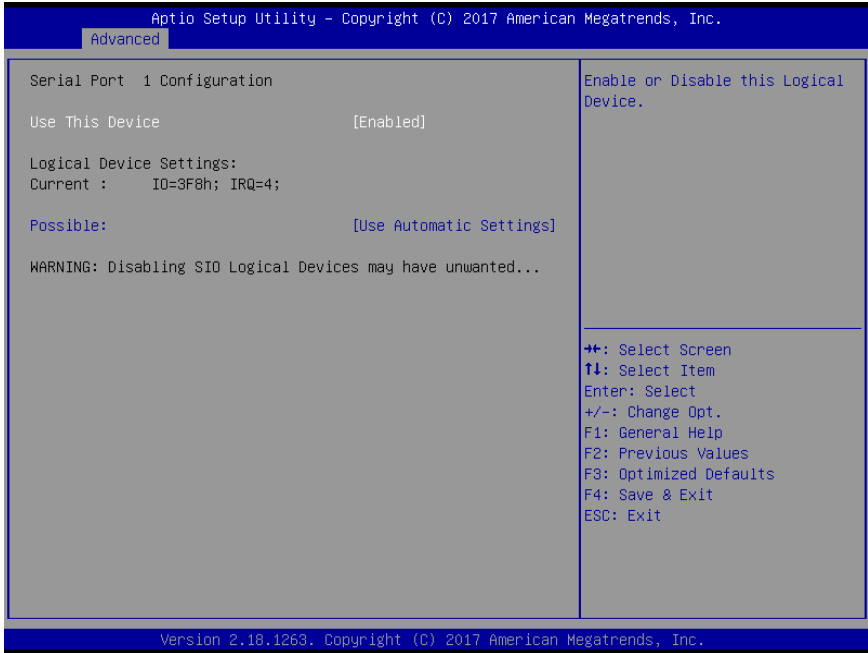

Options summary:

Use This Device	Disabled	Optimal Default, Failsafe Default
	Enabled	
Enable or Disable this Logical Device.		
Possible:	Use Automatic Settings	Optimal Default, Failsafe Default
	IO=3F8; IRQ=4;	
	IO=2F8; IRQ=3;	
Allows the user to change the device resource settings. New settings will be reflected on this setup page after system restarts.		

3.4.5.2 SIO Configuration: Serial Port 2 Configuration

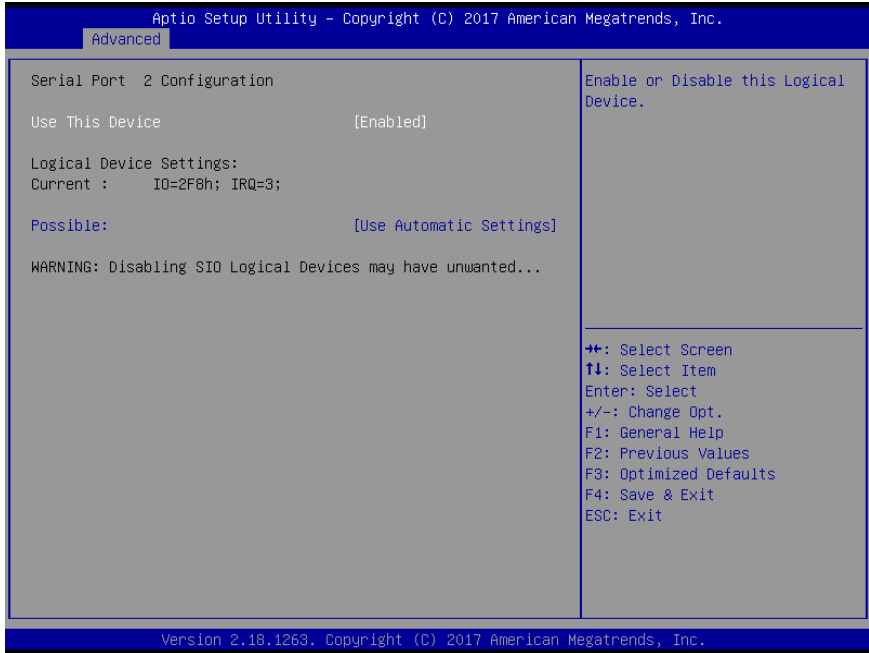

Options summary:

Use This Device	Disabled	Optimal Default, Failsafe Default
	Enabled	
Enable or Disable this Logical Device.		
Possible:	Use Automatic Settings	Optimal Default, Failsafe Default
	IO=2F8; IRQ=3;	
	IO=3F8; IRQ=4;	
Allows the user to change the device resource settings. New settings will be reflected on this setup page after system restarts.		

3.4.5.3 SIO Configuration: Serial Port 3 Configuration

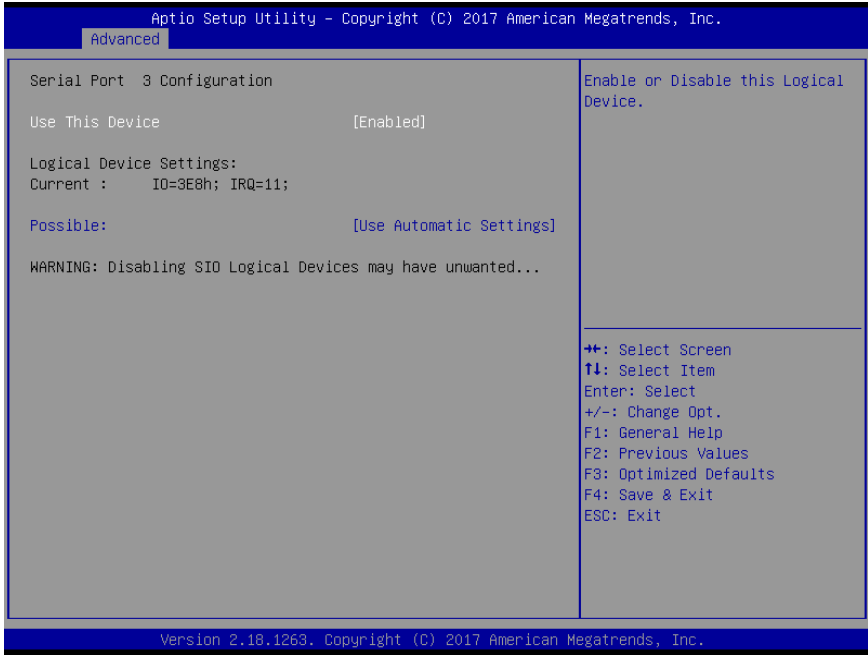

Options summary:

Use This Device	Disabled	Optimal Default, Failsafe Default
	Enabled	
Enable or Disable this Logical Device.		
Possible:	Use Automatic Settings	Optimal Default, Failsafe Default
	IO=3E8; IRQ=11;	
	IO=2E8; IRQ=11;	
Allows the user to change the device resource settings. New settings will be reflected on this setup page after system restarts.		

3.4.5.4 SIO Configuration: Serial Port 4 Configuration

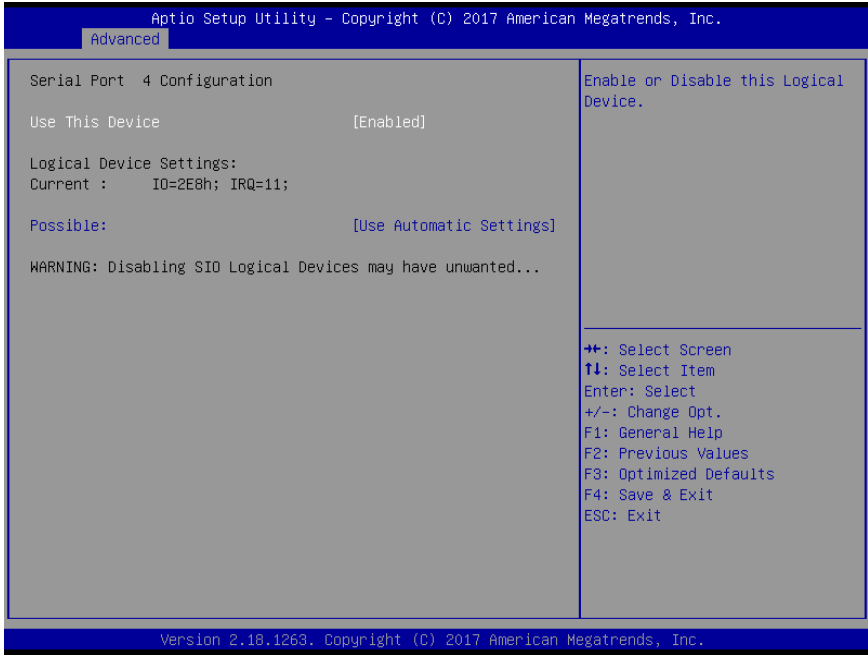

Options summary:

Use This Device	Disabled	Optimal Default, Failsafe Default
	Enabled	
Enable or Disable this Logical Device.		
Possible:	Use Automatic Settings	Optimal Default, Failsafe Default
	IO=2E8; IRQ=11;	
	IO=3E8; IRQ=11;	
Allows the user to change the device resource settings. New settings will be reflected on this setup page after system restarts.		

3.4.5.5 SIO Configuration: Serial Port 5 Configuration

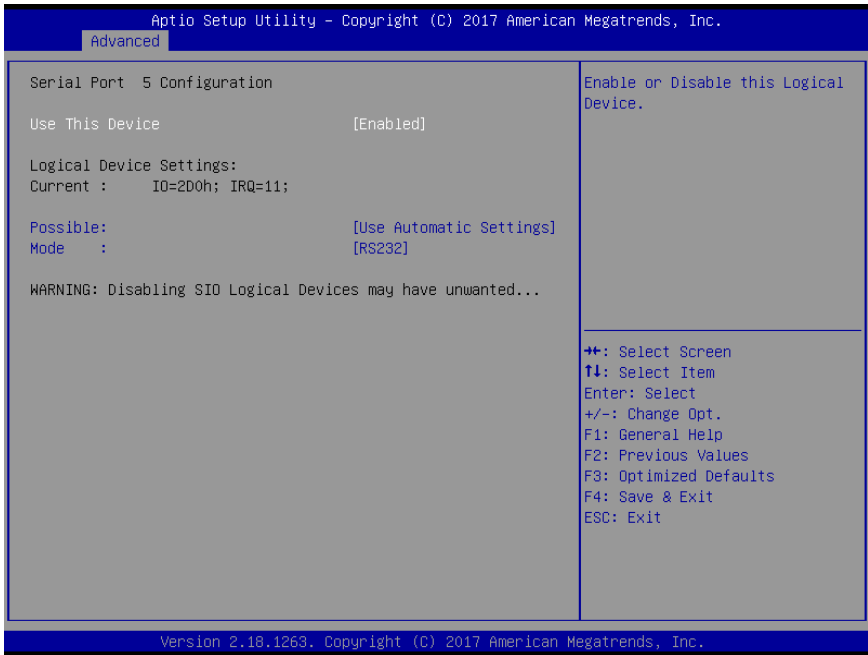

Options summary:

Use This Device	Disabled	Optimal Default, Failsafe Default
	Enabled	
Enable or Disable this Logical Device.		
Possible:	Use Automatic Settings	Optimal Default, Failsafe Default
	IO=2D0; IRQ=11;	
	IO=2C0; IRQ=11;	
Allows the user to change the device resource settings. New settings will be reflected on this setup page after system restarts.		
Mode:	RS232	Optimal Default, Failsafe Default
	RS422	
	RS458	
UART RS232 RS422 RS485 selection		

3.4.5.6 SIO Configuration: Serial Port 6 Configuration

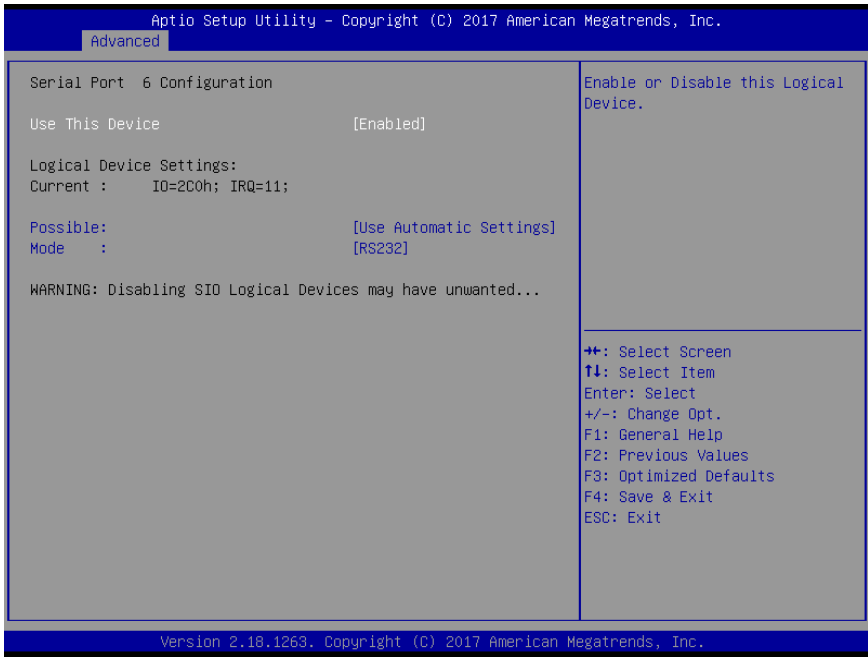

Options summary:

Use This Device	Disabled	Optimal Default, Failsafe Default
	Enabled	
Enable or Disable this Logical Device.		
Possible:	Use Automatic Settings	Optimal Default, Failsafe Default
	IO=2C0; IRQ=11;	
	IO=2D0; IRQ=11;	
Allows the user to change the device resource settings. New settings will be reflected on this setup page after system restarts.		
Mode:	RS232	Optimal Default, Failsafe Default
	RS422	
	RS458	
UART RS232 RS422 RS485 selection		

3.4.6 Advanced: Power Management

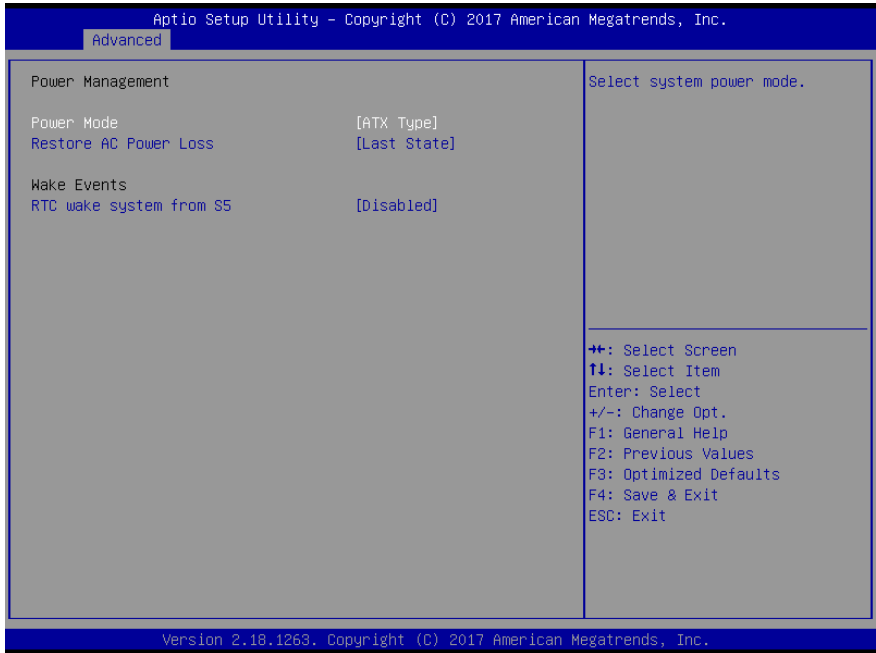

Options summary:

Power Mode	ATX Type	Optimal Default, Failsafe Default
	AT Type	
Select system power mode.		
Restore AC Power Loss	Last State	Optimal Default, Failsafe Default
	Power On	
	Power Loss	
RTC wake system from S5	Disabled	Optimal Default, Failsafe Default
	Fixed Time	
	Dynamic Time	
Enable or disable System wake on alarm event. When enabled, System will wake on the hr::min::sec specified		

3.4.7 Advanced: Dynamic Digital IO Configuration

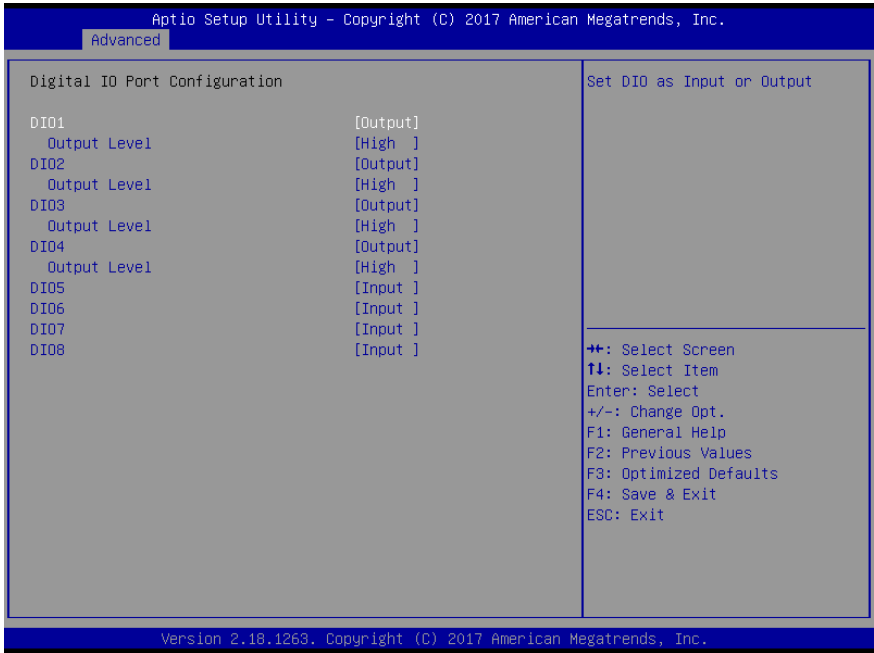

Options summary:

DIO[1:4]	Input	Optimal Default, Failsafe Default
	Output	
Set DIO as Input or Output		
DIO[1:4] Output Level	High	Optimal Default, Failsafe Default
	Low	
Set output level when DIO pin is output		
DIO[5:8]	Input	Optimal Default, Failsafe Default
	Output	
Set DIO as Input or Output		
DIO[5:8] Output Level	High	Optimal Default, Failsafe Default
	Low	
Set output level when DIO pin is output		

3.5 Setup submenu: Chipset

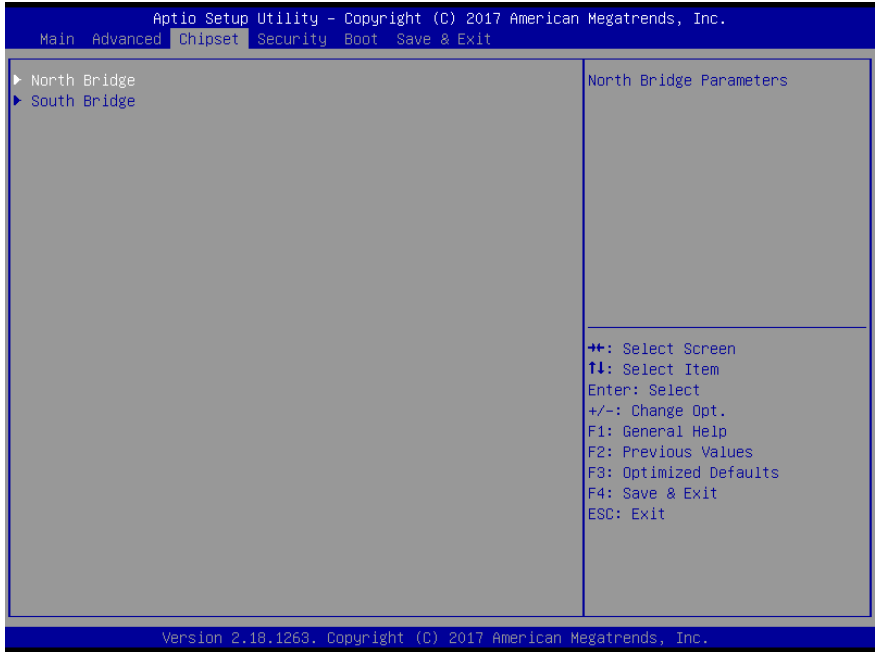

3.5.1 Chipset: North Bridge

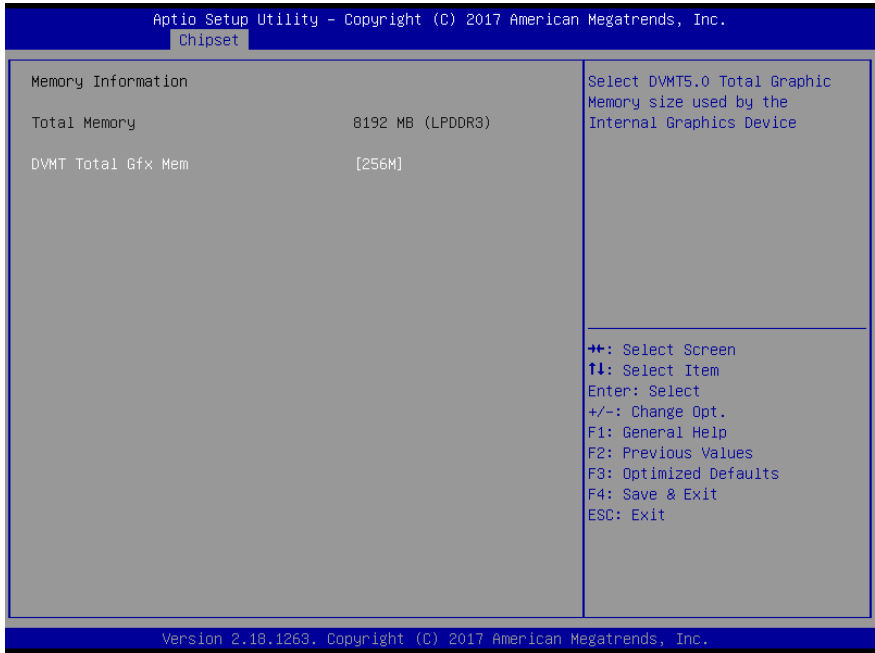

Options summary:

DCMT Total Gfx Mem	128M	Optimal Default, Failsafe Default
	256M	
	MAX	
Select DVMT5.0 Total Graphics Memory size used by the Internal Graphics Device		

3.5.2 Chipset: South Bridge

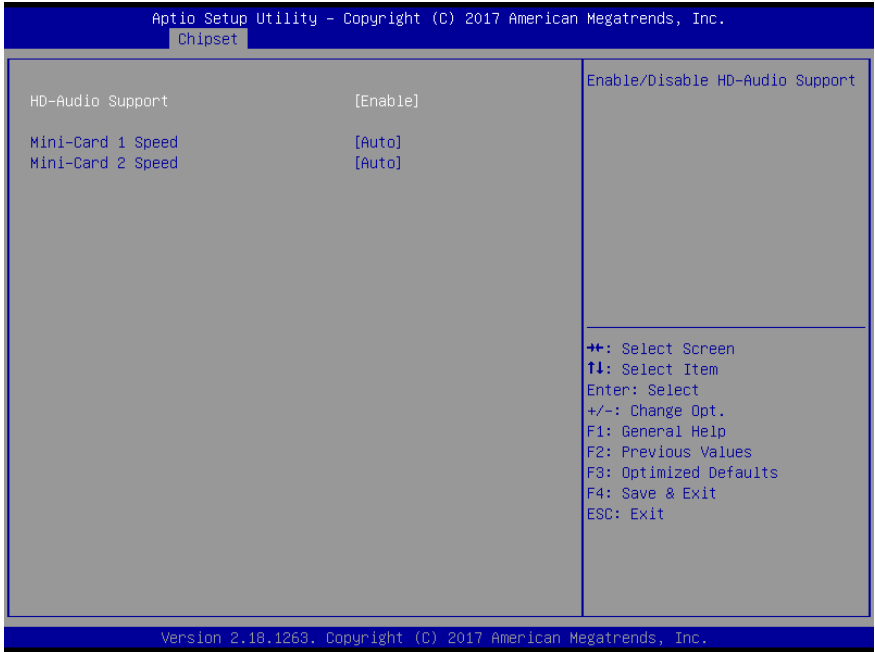

Options summary:

HD-Audio Support	Disable	Optimal Default, Failsafe Default
	Enable	
Enable/Disable HD-Audio Support		
Mini-Card 1 Speed	Auto	Optimal Default, Failsafe Default
	Gen 1	
	Gen 2	
Configure PCIe Speed		
Mini-Card 2 Speed	Auto	Optimal Default, Failsafe Default
	Gen 1	
	Gen 2	
Configure PCIe Speed		

3.6 Setup submenu: Security

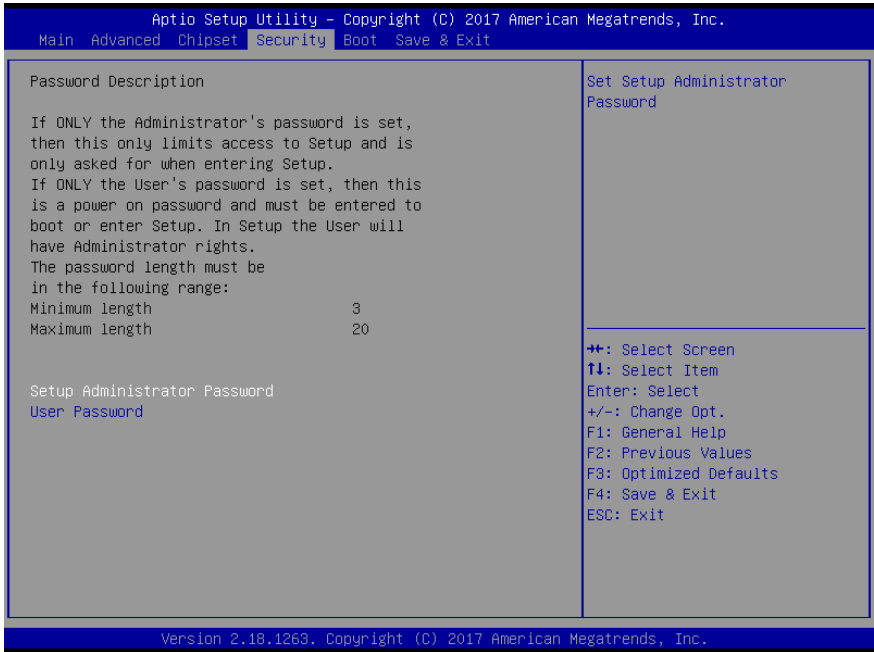

Change User/Administrator Password

You can set a User Password once an Administrator Password. The password will be required during boot up, or when the user enters the Setup utility. Please Note that a User Password does not provide access to many of the features in the Setup utility.

Select the password you wish to set, press Enter to open a dialog box to enter your password (you can enter no more than six letters or numbers). Press Enter to confirm your entry, after which you will be prompted to retype your password for a final confirmation. Press Enter again after you have retyped it correctly.

Removing the Password

Highlight this item and type in the current password. At the next dialog box press Enter to disable password protection.

3.7 Setup submenu: Boot

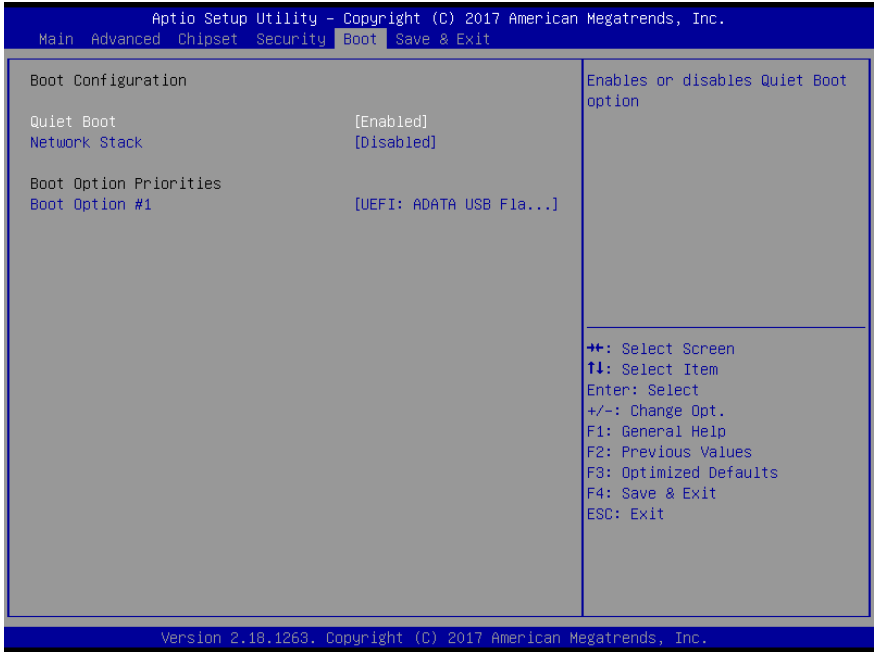

Options summary:

Quiet Boot	Disabled	Optimal Default, Failsafe Default
	Enabled	
Enable or Disable Quiet Boot option		
Network Stack	Disabled	Optimal Default, Failsafe Default
	Enabled	
Enable/Disable UEFI Network Stack		

3.8 Setup submenu: Save & Exit

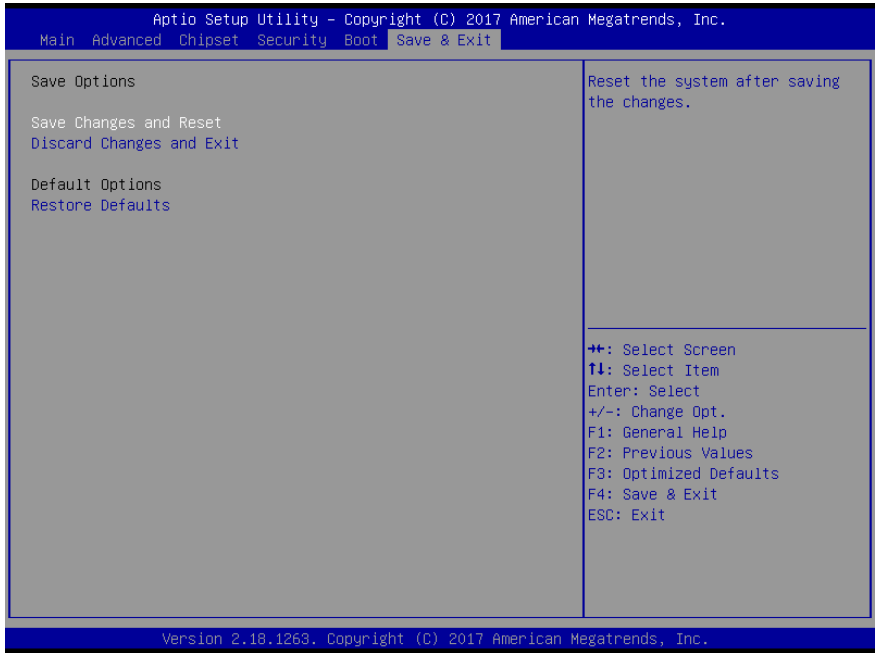

Chapter 4

Drivers Installation

4.1 Product CD/DVD

The BOXER-6616 comes with a product DVD that contains all the drivers and utilities you need to setup your product. Insert the DVD and follow the steps in the autorun program to install the drivers.

In case the program does not start, follow the sequence below to install the drivers.

Step 1 – Install Chipset Driver

1. Open the **Step1 - Chipset** folder and followed by **SetupChipset.exe** file
2. Follow the instructions
3. Drivers will be installed automatically

Step 2 – Install VGA Driver

1. Open the **Step2 - Graphic** folder and select your OS
2. Open the **Setup.exe** file in the folder
3. Follow the instructions
4. Drivers will be installed automatically

Step 3 – Install TXE Driver

1. Open the **Step3 - Audio** folder and select your OS
2. Open the **SetupTXE.exe** file in the folder
3. Follow the instructions
4. Drivers will be installed automatically

Step 4 – Install LAN Driver

1. Open the **Step4 - LAN** folder and select your OS
2. Open the **.exe** file in the folder

3. Follow the instructions
4. Drivers will be installed automatically

Step 5 – Install Audio Driver

1. Open the **Step5 - Audio** folder and followed by **.exe** file
2. Follow the instructions
3. Drivers will be installed automatically

Step 6 – Install Serial IO Driver

1. Open the **Step6 – Serial IO** folder and select your OS
2. Open the **SetupSerialIO.exe** file in the folder
3. Follow the instructions
4. Drivers will be installed automatically

Step 7 – Install Serial Port Driver (Optional)

- 1.
2. Open the **Step7 - Serial Port Driver (Optional)** folder and select your OS
3. Open the **.exe** file in the folder
4. Follow the instructions
5. Drivers will be installed automatically

Appendix A

Watchdog Timer Programming

A.1 Watchdog Timer Initial Program

Table 1 : SuperIO relative register table		
	Default Value	Note
Index	0x2E(Note1)	SIO MB PnP Mode Index Register 0x2E or 0x4E
Data	0x2F(Note2)	SIO MB PnP Mode Data Register 0x2F or 0x4F

Table 2 : Watchdog relative register table					
	LDN	Register	BitNum	Value	Note
Timer Counter	0x07(Note3)	0xF6(Note4)		(Note24)	Time of watchdog timer (0~255) This register is byte access
Counting Unit	0x07(Note5)	0xF5(Note6)	3(Note7)	0(Note8)	Select time unit. 0: second 1: minute
Watchdog Enable	0x07(Note9)	0xF5(Note10)	5(Note11)	1(Note12)	0: Disable 1: Enable
Timeout Status	0x07(Note13)	0xF5(Note14)	6(Note15)	1	1: Clear timeout status
Output Mode	0x07(Note16)	0xF5(Note17)	4(Note18)	1(Note19)	Select WDTRST# output mode 0: level 1: pulse
WDTRST output	0x07(Note20)	0xFA(Note21)	0(Note22)	1(Note23)	Enable/Disable time out output via WDTRST# 0: Disable 1: Enable

```

*****
// SuperIO relative definition (Please reference to Table 1)
#define byte   SIOIndex   //This parameter is represented from Note1
#define byte   SIOData    //This parameter is represented from Note2
#define void   IOWriteByte(byte IOPort, byte Value);
#define byte   IOReadByte(byte IOPort);
// Watch Dog relative definition (Please reference to Table 2)
#define byte   TimerLDN   //This parameter is represented from Note3
#define byte   TimerReg   //This parameter is represented from Note4
#define byte   TimerVal   // This parameter is represented from Note24
#define byte   UnitLDN    //This parameter is represented from Note5
#define byte   UnitReg    //This parameter is represented from Note6
#define byte   UnitBit    //This parameter is represented from Note7
#define byte   UnitVal    //This parameter is represented from Note8
#define byte   EnableLDN //This parameter is represented from Note9
#define byte   EnableReg  //This parameter is represented from Note10
#define byte   EnableBit  //This parameter is represented from Note11
#define byte   EnableVal  //This parameter is represented from Note12
#define byte   StatusLDN // This parameter is represented from Note13
#define byte   StatusReg  // This parameter is represented from Note14
#define byte   StatusBit  // This parameter is represented from Note15
#define byte   ModeLDN   // This parameter is represented from Note16
#define byte   ModeReg   // This parameter is represented from Note17
#define byte   ModeBit   // This parameter is represented from Note18
#define byte   ModeVal   // This parameter is represented from Note19
#define byte   WDTRstLDN // This parameter is represented from Note20
#define byte   WDTRstReg // This parameter is represented from Note21
#define byte   WDTRstBit // This parameter is represented from Note22
#define byte   WDTRstVal // This parameter is represented from Note23
*****

```

```
*****
VOID Main(){
    // Procedure : AaeonWDTConfig
    // (byte)Timer : Time of WDT timer.(0x00~0xFF)
    // (boolean)Unit : Select time unit(0: second, 1: minute).
    AaeonWDTConfig();

    // Procedure : AaeonWDTEnable
    // This procedure will enable the WDT counting.
    AaeonWDTEnable();
}
*****
```

```

*****
// Procedure : AaeonWDTEnable
VOID AaeonWDTEnable (){
    WDTEnableDisable(EnableLDN, EnableReg, EnableBit, 1);
}

// Procedure : AaeonWDTConfig
VOID AaeonWDTConfig (){
    // Disable WDT counting
    WDTEnableDisable(EnableLDN, EnableReg, EnableBit, 0);
    // Clear Watchdog Timeout Status
    WDTClearTimeoutStatus();
    // WDT relative parameter setting
    WDTParameterSetting();
}

VOID WDTEnableDisable(byte LDN, byte Register, byte BitNum, byte Value){
    SIOBitSet(LDN, Register, BitNum, Value);
}

VOID WDTParameterSetting(){
    // Watchdog Timer counter setting
    SIOByteSet(TimerLDN, TimerReg, TimerVal);
    // WDT counting unit setting
    SIOBitSet(UnitLDN, UnitReg, UnitBit, UnitVal);
    // WDT output mode setting, level / pulse
    SIOBitSet(ModelLDN, ModeReg, ModeBit, ModeVal);
    // Watchdog timeout output via WDTRST#
    SIOBitSet(WDTRstLDN, WDTRstReg, WDTRstBit, WDTRstVal);
}

VOID WDTClearTimeoutStatus(){
    SIOBitSet(StatusLDN, StatusReg, StatusBit, 1);
}
*****

```

```

*****
VOID  SIOEnterMBPnPMode(){
    IOWriteByte(SIOIndex, 0x87);
    IOWriteByte(SIOIndex, 0x87);
}

VOID  SIOExitMBPnPMode(){
    IOWriteByte(SIOIndex, 0xAA);
}

VOID  SIOSelectLDN(byte LDN){
    IOWriteByte(SIOIndex, 0x07); // SIO LDN Register Offset = 0x07
    IOWriteByte(SIOData, LDN);
}

VOID  SIOBitSet(byte LDN, byte Register, byte BitNum, byte Value){
    Byte TmpValue;

    SIOEnterMBPnPMode();
    SIOSelectLDN(byte LDN);
    IOWriteByte(SIOIndex, Register);
    TmpValue = IOReadByte(SIOData);
    TmpValue &= ~(1 << BitNum);
    TmpValue |= (Value << BitNum);
    IOWriteByte(SIOData, TmpValue);
    SIOExitMBPnPMode();
}

VOID  SIOByteSet(byte LDN, byte Register, byte Value){
    SIOEnterMBPnPMode();
    SIOSelectLDN(LDN);
    IOWriteByte(SIOIndex, Register);
    IOWriteByte(SIOData, Value);
    SIOExitMBPnPMode();
}
*****

```













Appendix B

I/O Information

B.1 I/O Address Map

Address Range	Device Name
[0000000000000000 - 000000000000006F]	PCI Express Root Complex
[0000000000000020 - 0000000000000021]	Programmable interrupt controller
[0000000000000020 - 0000000000000021]	Programmable interrupt controller
[0000000000000020 - 0000000000000021]	Programmable interrupt controller
[0000000000000024 - 0000000000000025]	Programmable interrupt controller
[0000000000000024 - 0000000000000025]	Programmable interrupt controller
[0000000000000024 - 0000000000000025]	Programmable interrupt controller
[0000000000000028 - 0000000000000029]	Programmable interrupt controller
[0000000000000028 - 0000000000000029]	Programmable interrupt controller
[0000000000000028 - 0000000000000029]	Programmable interrupt controller
[000000000000002C - 000000000000002D]	Programmable interrupt controller
[000000000000002C - 000000000000002D]	Programmable interrupt controller
[000000000000002C - 000000000000002D]	Programmable interrupt controller
[000000000000002E - 000000000000002F]	Motherboard resources
[0000000000000030 - 0000000000000031]	Programmable interrupt controller
[0000000000000030 - 0000000000000031]	Programmable interrupt controller
[0000000000000030 - 0000000000000031]	Programmable interrupt controller
[0000000000000034 - 0000000000000035]	Programmable interrupt controller
[0000000000000034 - 0000000000000035]	Programmable interrupt controller
[0000000000000034 - 0000000000000035]	Programmable interrupt controller
[0000000000000038 - 0000000000000039]	Programmable interrupt controller
[0000000000000038 - 0000000000000039]	Programmable interrupt controller
[0000000000000038 - 0000000000000039]	Programmable interrupt controller
[000000000000003C - 000000000000003D]	Programmable interrupt controller
[000000000000003C - 000000000000003D]	Programmable interrupt controller
[000000000000003C - 000000000000003D]	Programmable interrupt controller
[0000000000000040 - 0000000000000043]	System timer
[0000000000000040 - 0000000000000043]	System timer
[0000000000000040 - 0000000000000043]	System timer
[000000000000004E - 000000000000004F]	Motherboard resources
[0000000000000050 - 0000000000000053]	System timer
[0000000000000050 - 0000000000000053]	System timer
[0000000000000050 - 0000000000000053]	System timer
[0000000000000061 - 0000000000000061]	Motherboard resources
[0000000000000063 - 0000000000000063]	Motherboard resources
[0000000000000065 - 0000000000000065]	Motherboard resources
[0000000000000067 - 0000000000000067]	Motherboard resources
[0000000000000070 - 0000000000000070]	Motherboard resources
[0000000000000070 - 0000000000000077]	System CMOS/real time clock
[0000000000000078 - 00000000000000CF7]	PCI Express Root Complex
[0000000000000080 - 000000000000008F]	Motherboard resources
[0000000000000092 - 0000000000000092]	Motherboard resources
[00000000000000A0 - 00000000000000A1]	Programmable interrupt controller
[00000000000000A0 - 00000000000000A1]	Programmable interrupt controller
[00000000000000A0 - 00000000000000A1]	Programmable interrupt controller
[00000000000000A4 - 00000000000000A5]	Programmable interrupt controller
[00000000000000A4 - 00000000000000A5]	Programmable interrupt controller
[00000000000000A4 - 00000000000000A5]	Programmable interrupt controller
[00000000000000A8 - 00000000000000A9]	Programmable interrupt controller
[00000000000000A8 - 00000000000000A9]	Programmable interrupt controller

[00000000000000A8 - 00000000000000A9]	Programmable interrupt controller
[00000000000000AC - 00000000000000AD]	Programmable interrupt controller
[00000000000000AC - 00000000000000AD]	Programmable interrupt controller
[00000000000000AC - 00000000000000AD]	Programmable interrupt controller
[00000000000000B0 - 00000000000000B1]	Programmable interrupt controller
[00000000000000B0 - 00000000000000B1]	Programmable interrupt controller
[00000000000000B0 - 00000000000000B1]	Programmable interrupt controller
[00000000000000B2 - 00000000000000B3]	Motherboard resources
[00000000000000B4 - 00000000000000B5]	Programmable interrupt controller
[00000000000000B4 - 00000000000000B5]	Programmable interrupt controller
[00000000000000B4 - 00000000000000B5]	Programmable interrupt controller
[00000000000000B8 - 00000000000000B9]	Programmable interrupt controller
[00000000000000B8 - 00000000000000B9]	Programmable interrupt controller
[00000000000000B8 - 00000000000000B9]	Programmable interrupt controller
[00000000000000B8 - 00000000000000B9]	Programmable interrupt controller
[00000000000000BC - 00000000000000BD]	Programmable interrupt controller
[00000000000000BC - 00000000000000BD]	Programmable interrupt controller
[00000000000000BC - 00000000000000BD]	Programmable interrupt controller
[00000000000002C0 - 00000000000002C7]	Communications Port (COM6)
[00000000000002D0 - 00000000000002D7]	Communications Port (COM5)
[00000000000002E8 - 00000000000002EF]	Communications Port (COM4)
[00000000000002F8 - 00000000000002FF]	Communications Port (COM2)
[00000000000003E8 - 00000000000003EF]	Communications Port (COM3)
[00000000000003F8 - 00000000000003FF]	Communications Port (COM1)
[0000000000000400 - 000000000000047F]	Motherboard resources
[00000000000004D0 - 00000000000004D1]	Programmable interrupt controller
[00000000000004D0 - 00000000000004D1]	Programmable interrupt controller
[00000000000004D0 - 00000000000004D1]	Programmable interrupt controller
[0000000000000500 - 00000000000005FF]	Motherboard resources
[0000000000000680 - 00000000000006FF]	Motherboard resources
[0000000000000A00 - 0000000000000A0F]	Motherboard resources
[0000000000000A00 - 0000000000000A0F]	Motherboard resources
[0000000000000A10 - 0000000000000A1F]	Motherboard resources
[0000000000000A10 - 0000000000000A1F]	Motherboard resources
[0000000000000A20 - 0000000000000A2F]	Motherboard resources
[0000000000000A20 - 0000000000000A2F]	Motherboard resources
[0000000000000D00 - 0000000000000FFF]	PCI Express Root Complex
[0000000000000B00 - 0000000000000BFF]	PCI-to-PCI Bridge
[0000000000000C00 - 0000000000000CFF]	PCI-to-PCI Bridge
[0000000000000D00 - 0000000000000DFF]	Intel(R) Celeron(R)/Pentium(R) Processor PCI Express Root Port - 5AD9
[0000000000000D00 - 0000000000000DFF]	Intel(R) Celeron(R)/Pentium(R) Processor PCI Express Root Port - 5AD9
[0000000000000D00 - 0000000000000DFF]	PCI-to-PCI Bridge
[0000000000000E00 - 0000000000000E1F]	SM Bus Controller
[0000000000000E00 - 0000000000000EFF]	Intel(R) Celeron(R)/Pentium(R) Processor PCI Express Root Port - 5AD8
[0000000000000E00 - 0000000000000EFF]	Intel(R) Celeron(R)/Pentium(R) Processor PCI Express Root Port - 5AD8
[0000000000000E20 - 0000000000000E3F]	Standard SATA AHCI Controller
[0000000000000E40 - 0000000000000E43]	Standard SATA AHCI Controller
[0000000000000E50 - 0000000000000E57]	Standard SATA AHCI Controller
[0000000000000E60 - 0000000000000E63]	Standard SATA AHCI Controller

-  [000000000000E070 - 000000000000E077] Standard SATA AHCI Controller
-  [000000000000E080 - 000000000000E087] Microsoft Basic Display Adapter
-  [000000000000F000 - 000000000000F03F] Intel(R) HD Graphics
-  [000000000000F000 - 000000000000F03F] Intel(R) HD Graphics
-  [000000000000F040 - 000000000000F05F] Intel(R) Celeron(R)/Pentium(R) Processor SMBUS - 5AD4
-  [000000000000F040 - 000000000000F05F] Intel(R) Celeron(R)/Pentium(R) Processor SMBUS - 5AD4
-  [000000000000F060 - 000000000000F07F] Standard SATA AHCI Controller
-  [000000000000F060 - 000000000000F07F] Standard SATA AHCI Controller
-  [000000000000F080 - 000000000000F083] Standard SATA AHCI Controller
-  [000000000000F080 - 000000000000F083] Standard SATA AHCI Controller
-  [000000000000F090 - 000000000000F097] Standard SATA AHCI Controller
-  [000000000000F090 - 000000000000F097] Standard SATA AHCI Controller





















































B.2 Memory Address Map





















































Address Range	Device Name
[000000007B800001 - 000000007BFFFFFF]	PCI Express Root Complex
[000000007C000001 - 000000007FFFFFFF]	PCI Express Root Complex
[0000000080000000 - 0000000080FFFFFF]	Intel(R) HD Graphics
[0000000080000000 - 000000008FFFFFFF]	Intel(R) HD Graphics
[0000000080000000 - 00000000CFFFFFFF]	PCI Express Root Complex
[0000000081000000 - 00000000810FFFFFFF]	High Definition Audio Controller
[0000000081100000 - 00000000811FFFFFFF]	Intel(R) Celeron(R)/Pentium(R) Processor PCI Express Root Port - 5AD9
[00000000811DC000 - 00000000811DFFFFF]	Intel(R) I211 Gigabit Network Connection
[00000000811E0000 - 00000000811FFFFFFF]	Intel(R) I211 Gigabit Network Connection
[0000000081200000 - 00000000812FFFFFFF]	Intel(R) Celeron(R)/Pentium(R) Processor PCI Express Root Port - 5AD8
[00000000812DC000 - 00000000812DFFFFF]	Intel(R) I211 Gigabit Network Connection #2
[00000000812E0000 - 00000000812FFFFFFF]	Intel(R) I211 Gigabit Network Connection #2
[0000000081300000 - 000000008130FFFFFF]	Intel(R) USB 3.0 eXtensible Host Controller - 1.0 (Microsoft)
[0000000081310000 - 0000000081313FFFFF]	High Definition Audio Controller
[0000000081314000 - 0000000081315FFFFF]	Standard SATA AHCI Controller
[0000000081318000 - 00000000813180FFFF]	Intel(R) Celeron(R)/Pentium(R) Processor SMBUS - 5AD4
[0000000081319000 - 00000000813197FFFF]	Standard SATA AHCI Controller
[000000008131A000 - 000000008131A0FFFF]	Standard SATA AHCI Controller
[000000008131E000 - 000000008131EFFFFF]	Intel(R) Trusted Execution Engine Interface
[0000000090000000 - 0000000090FFFFFFF]	Intel(R) HD Graphics
[0000000090000000 - 000000009FFFFFFF]	Intel(R) HD Graphics
[0000000091000000 - 00000000910FFFFFFF]	High Definition Audio Controller
[0000000091100000 - 00000000911FFFFFFF]	Intel(R) Celeron(R)/Pentium(R) Processor PCI Express Root Port - 5AD9
[0000000091200000 - 00000000912FFFFFFF]	Intel(R) Celeron(R)/Pentium(R) Processor PCI Express Root Port - 5AD8
[0000000091300000 - 000000009130FFFFFF]	Intel(R) USB 3.0 eXtensible Host Controller - 1.0 (Microsoft)
[0000000091310000 - 0000000091313FFFFF]	High Definition Audio Controller
[0000000091314000 - 0000000091315FFFFF]	Standard SATA AHCI Controller
[0000000091318000 - 00000000913180FFFF]	Intel(R) Celeron(R)/Pentium(R) Processor SMBUS - 5AD4
[0000000091319000 - 00000000913197FFFF]	Standard SATA AHCI Controller
[000000009131A000 - 000000009131A0FFFF]	Standard SATA AHCI Controller
[000000009131E000 - 000000009131EFFFFF]	Intel(R) Trusted Execution Engine Interface
[00000000C0000000 - 00000000CFFFFFFF]	Microsoft Basic Display Adapter
[00000000D0000000 - 00000000D03FFFFFFF]	Microsoft Basic Display Adapter
[00000000D0400000 - 00000000D04FFFFFFF]	PCI-to-PCI Bridge
[00000000D0500000 - 00000000D05FFFFFFF]	PCI-to-PCI Bridge
[00000000D0600000 - 00000000D06FFFFFFF]	PCI-to-PCI Bridge
[00000000D0700000 - 00000000D0703FFFFF]	High Definition Audio Controller
[00000000D0704000 - 00000000D070401F]	SM Bus Controller
[00000000D0705000 - 00000000D07053FF]	Standard Enhanced PCI to USB Host Controller
[00000000D0706000 - 00000000D07067FF]	Standard SATA AHCI Controller
[00000000D0C00000 - 00000000D0C00653]	Intel(R) Serial IO GPIO Host Controller - INT3452
[00000000D0C40000 - 00000000D0C40763]	Intel(R) Serial IO GPIO Host Controller - INT3452
[00000000D0C50000 - 00000000D0C5076B]	Intel(R) Serial IO GPIO Host Controller - INT3452
[00000000D0C70000 - 00000000D0C70673]	Intel(R) Serial IO GPIO Host Controller - INT3452
[00000000E0000000 - 00000000EFFFFFFF]	Motherboard resources
[00000000E0000000 - 00000000EFFFFFFF]	PCI Express Root Complex
[00000000E00000D0 - 00000000E00000DB]	Unknown device
[00000000FEA00000 - 00000000FEAFFFFFFF]	Motherboard resources
[00000000FED00000 - 00000000FED003FF]	High precision event timer
[00000000FED01000 - 00000000FED01FFF]	Motherboard resources
[00000000FED03000 - 00000000FED03FFF]	Motherboard resources





















































[00000000D0400000 - 00000000D04FFFFF]	PCI-to-PCI Bridge
[00000000D0500000 - 00000000D05FFFFF]	PCI-to-PCI Bridge
[00000000D0600000 - 00000000D06FFFFF]	PCI-to-PCI Bridge
[00000000D0700000 - 00000000D0703FFF]	High Definition Audio Controller
[00000000D0704000 - 00000000D070401F]	SM Bus Controller
[00000000D0705000 - 00000000D07053FF]	Standard Enhanced PCI to USB Host Controller
[00000000D0706000 - 00000000D07067FF]	Standard SATA AHCI Controller
[00000000D0C00000 - 00000000D0C00653]	Intel(R) Serial IO GPIO Host Controller - INT3452
[00000000D0C40000 - 00000000D0C40763]	Intel(R) Serial IO GPIO Host Controller - INT3452
[00000000D0C50000 - 00000000D0C5076B]	Intel(R) Serial IO GPIO Host Controller - INT3452
[00000000D0C70000 - 00000000D0C70673]	Intel(R) Serial IO GPIO Host Controller - INT3452
[00000000E0000000 - 00000000EFFFFFFF]	Motherboard resources
[00000000E0000000 - 00000000EFFFFFFF]	PCI Express Root Complex
[00000000E00000D0 - 00000000E00000DB]	Unknown device
[00000000FEA00000 - 00000000FEAFFFFF]	Motherboard resources
[00000000FED00000 - 00000000FED003FF]	High precision event timer
[00000000FED01000 - 00000000FED01FFF]	Motherboard resources
[00000000FED03000 - 00000000FED03FFF]	Motherboard resources
[00000000FED06000 - 00000000FED06FFF]	Motherboard resources
[00000000FED08000 - 00000000FED09FFF]	Motherboard resources
[00000000FED1C000 - 00000000FED1CFFF]	Motherboard resources
[00000000FED80000 - 00000000FEDBFFFF]	Motherboard resources
[00000000FEE00000 - 00000000FEEFFFFFFF]	Motherboard resources
[00000000FF000000 - 00000000FFFFFFF]	Legacy device





















































B.3 IRQ Mapping Chart





















































▼	Interrupt request (IRQ)	
	(ISA) 0x00000000 (00)	System timer
	(ISA) 0x00000000 (00)	System timer
	(ISA) 0x00000000 (00)	System timer
	(ISA) 0x00000003 (03)	Communications Port (COM2)
	(ISA) 0x00000004 (04)	Communications Port (COM1)
	(ISA) 0x00000005 (05)	PCI-to-PCI Bridge
	(ISA) 0x00000005 (05)	PCI-to-PCI Bridge
	(ISA) 0x00000005 (05)	PCI-to-PCI Bridge
	(ISA) 0x00000005 (05)	Standard Enhanced PCI to USB Host Controller
	(ISA) 0x00000005 (05)	Standard SATA AHCI Controller
	(ISA) 0x00000008 (08)	High precision event timer
	(ISA) 0x0000000A (10)	High Definition Audio Controller
	(ISA) 0x0000000A (10)	Microsoft Basic Display Adapter
	(ISA) 0x0000000A (10)	PCI-to-PCI Bridge
	(ISA) 0x0000000A (10)	PCI-to-PCI Bridge
	(ISA) 0x0000000A (10)	PCI-to-PCI Bridge
	(ISA) 0x0000000A (10)	PCI-to-PCI Bridge
	(ISA) 0x0000000A (10)	PCI-to-PCI Bridge
	(ISA) 0x0000000A (10)	PCI-to-PCI Bridge
	(ISA) 0x0000000A (10)	SM Bus Controller
	(ISA) 0x0000000B (11)	Communications Port (COM3)
	(ISA) 0x0000000B (11)	Communications Port (COM4)
	(ISA) 0x0000000B (11)	Communications Port (COM5)
	(ISA) 0x0000000B (11)	Communications Port (COM6)
	(ISA) 0x0000000E (14)	Intel(R) Serial IO GPIO Host Controller - INT3452
	(ISA) 0x0000000E (14)	Intel(R) Serial IO GPIO Host Controller - INT3452
	(ISA) 0x0000000E (14)	Intel(R) Serial IO GPIO Host Controller - INT3452
	(ISA) 0x0000000E (14)	Intel(R) Serial IO GPIO Host Controller - INT3452
	(ISA) 0x00000011 (17)	Intel(R) USB 3.0 eXtensible Host Controller - 1.0 (Microsoft)
	(ISA) 0x00000019 (25)	High Definition Audio Controller
	(ISA) 0x00000036 (54)	Microsoft ACPI-Compliant System
	(ISA) 0x00000037 (55)	Microsoft ACPI-Compliant System
	(ISA) 0x00000038 (56)	Microsoft ACPI-Compliant System
	(ISA) 0x00000039 (57)	Microsoft ACPI-Compliant System
	(ISA) 0x0000003A (58)	Microsoft ACPI-Compliant System
	(ISA) 0x0000003B (59)	Microsoft ACPI-Compliant System
	(ISA) 0x0000003C (60)	Microsoft ACPI-Compliant System
	(ISA) 0x0000003D (61)	Microsoft ACPI-Compliant System
	(ISA) 0x0000003E (62)	Microsoft ACPI-Compliant System
	(ISA) 0x0000003F (63)	Microsoft ACPI-Compliant System
	(ISA) 0x00000040 (64)	Microsoft ACPI-Compliant System
	(ISA) 0x00000041 (65)	Microsoft ACPI-Compliant System
	(ISA) 0x00000042 (66)	Microsoft ACPI-Compliant System
	(ISA) 0x00000043 (67)	Microsoft ACPI-Compliant System
	(ISA) 0x00000044 (68)	Microsoft ACPI-Compliant System
	(ISA) 0x00000045 (69)	Microsoft ACPI-Compliant System
	(ISA) 0x00000046 (70)	Microsoft ACPI-Compliant System
	(ISA) 0x00000047 (71)	Microsoft ACPI-Compliant System
	(ISA) 0x00000048 (72)	Microsoft ACPI-Compliant System
	(ISA) 0x00000049 (73)	Microsoft ACPI-Compliant System
	(ISA) 0x0000004A (74)	Microsoft ACPI-Compliant System





















































 (ISA) 0x0000004B (75)	Microsoft ACPI-Compliant System
 (ISA) 0x0000004C (76)	Microsoft ACPI-Compliant System
 (ISA) 0x0000004D (77)	Microsoft ACPI-Compliant System
 (ISA) 0x0000004E (78)	Microsoft ACPI-Compliant System
 (ISA) 0x0000004F (79)	Microsoft ACPI-Compliant System
 (ISA) 0x00000050 (80)	Microsoft ACPI-Compliant System
 (ISA) 0x00000051 (81)	Microsoft ACPI-Compliant System
 (ISA) 0x00000052 (82)	Microsoft ACPI-Compliant System
 (ISA) 0x00000053 (83)	Microsoft ACPI-Compliant System
 (ISA) 0x00000054 (84)	Microsoft ACPI-Compliant System
 (ISA) 0x00000055 (85)	Microsoft ACPI-Compliant System
 (ISA) 0x00000056 (86)	Microsoft ACPI-Compliant System
 (ISA) 0x00000057 (87)	Microsoft ACPI-Compliant System
 (ISA) 0x00000058 (88)	Microsoft ACPI-Compliant System
 (ISA) 0x00000059 (89)	Microsoft ACPI-Compliant System
 (ISA) 0x0000005A (90)	Microsoft ACPI-Compliant System
 (ISA) 0x0000005B (91)	Microsoft ACPI-Compliant System
 (ISA) 0x0000005C (92)	Microsoft ACPI-Compliant System
 (ISA) 0x0000005D (93)	Microsoft ACPI-Compliant System
 (ISA) 0x0000005E (94)	Microsoft ACPI-Compliant System
 (ISA) 0x0000005F (95)	Microsoft ACPI-Compliant System
 (ISA) 0x00000060 (96)	Microsoft ACPI-Compliant System
 (ISA) 0x00000061 (97)	Microsoft ACPI-Compliant System
 (ISA) 0x00000062 (98)	Microsoft ACPI-Compliant System
 (ISA) 0x00000063 (99)	Microsoft ACPI-Compliant System
 (ISA) 0x00000064 (100)	Microsoft ACPI-Compliant System
 (ISA) 0x00000065 (101)	Microsoft ACPI-Compliant System
 (ISA) 0x00000066 (102)	Microsoft ACPI-Compliant System
 (ISA) 0x00000067 (103)	Microsoft ACPI-Compliant System
 (ISA) 0x00000068 (104)	Microsoft ACPI-Compliant System
 (ISA) 0x00000069 (105)	Microsoft ACPI-Compliant System
 (ISA) 0x0000006A (106)	Microsoft ACPI-Compliant System
 (ISA) 0x0000006B (107)	Microsoft ACPI-Compliant System
 (ISA) 0x0000006C (108)	Microsoft ACPI-Compliant System
 (ISA) 0x0000006D (109)	Microsoft ACPI-Compliant System
 (ISA) 0x0000006E (110)	Microsoft ACPI-Compliant System
 (ISA) 0x0000006F (111)	Microsoft ACPI-Compliant System
 (ISA) 0x00000070 (112)	Microsoft ACPI-Compliant System
 (ISA) 0x00000071 (113)	Microsoft ACPI-Compliant System
 (ISA) 0x00000072 (114)	Microsoft ACPI-Compliant System
 (ISA) 0x00000073 (115)	Microsoft ACPI-Compliant System
 (ISA) 0x00000074 (116)	Microsoft ACPI-Compliant System
 (ISA) 0x00000075 (117)	Microsoft ACPI-Compliant System
 (ISA) 0x00000076 (118)	Microsoft ACPI-Compliant System
 (ISA) 0x00000077 (119)	Microsoft ACPI-Compliant System
 (ISA) 0x00000078 (120)	Microsoft ACPI-Compliant System
 (ISA) 0x00000079 (121)	Microsoft ACPI-Compliant System
 (ISA) 0x0000007A (122)	Microsoft ACPI-Compliant System
 (ISA) 0x0000007B (123)	Microsoft ACPI-Compliant System
 (ISA) 0x0000007C (124)	Microsoft ACPI-Compliant System
 (ISA) 0x0000007D (125)	Microsoft ACPI-Compliant System
 (ISA) 0x0000007E (126)	Microsoft ACPI-Compliant System





















































 (ISA) 0x0000007F (127)	Microsoft ACPI-Compliant System
 (ISA) 0x00000080 (128)	Microsoft ACPI-Compliant System
 (ISA) 0x00000081 (129)	Microsoft ACPI-Compliant System
 (ISA) 0x00000082 (130)	Microsoft ACPI-Compliant System
 (ISA) 0x00000083 (131)	Microsoft ACPI-Compliant System
 (ISA) 0x00000084 (132)	Microsoft ACPI-Compliant System
 (ISA) 0x00000085 (133)	Microsoft ACPI-Compliant System
 (ISA) 0x00000086 (134)	Microsoft ACPI-Compliant System
 (ISA) 0x00000087 (135)	Microsoft ACPI-Compliant System
 (ISA) 0x00000088 (136)	Microsoft ACPI-Compliant System
 (ISA) 0x00000089 (137)	Microsoft ACPI-Compliant System
 (ISA) 0x0000008A (138)	Microsoft ACPI-Compliant System
 (ISA) 0x0000008B (139)	Microsoft ACPI-Compliant System
 (ISA) 0x0000008C (140)	Microsoft ACPI-Compliant System
 (ISA) 0x0000008D (141)	Microsoft ACPI-Compliant System
 (ISA) 0x0000008E (142)	Microsoft ACPI-Compliant System
 (ISA) 0x0000008F (143)	Microsoft ACPI-Compliant System
 (ISA) 0x00000090 (144)	Microsoft ACPI-Compliant System
 (ISA) 0x00000091 (145)	Microsoft ACPI-Compliant System
 (ISA) 0x00000092 (146)	Microsoft ACPI-Compliant System
 (ISA) 0x00000093 (147)	Microsoft ACPI-Compliant System
 (ISA) 0x00000094 (148)	Microsoft ACPI-Compliant System
 (ISA) 0x00000095 (149)	Microsoft ACPI-Compliant System
 (ISA) 0x00000096 (150)	Microsoft ACPI-Compliant System
 (ISA) 0x00000097 (151)	Microsoft ACPI-Compliant System
 (ISA) 0x00000098 (152)	Microsoft ACPI-Compliant System
 (ISA) 0x00000099 (153)	Microsoft ACPI-Compliant System
 (ISA) 0x0000009A (154)	Microsoft ACPI-Compliant System
 (ISA) 0x0000009B (155)	Microsoft ACPI-Compliant System
 (ISA) 0x0000009C (156)	Microsoft ACPI-Compliant System
 (ISA) 0x0000009D (157)	Microsoft ACPI-Compliant System
 (ISA) 0x0000009E (158)	Microsoft ACPI-Compliant System
 (ISA) 0x0000009F (159)	Microsoft ACPI-Compliant System
 (ISA) 0x000000A0 (160)	Microsoft ACPI-Compliant System
 (ISA) 0x000000A1 (161)	Microsoft ACPI-Compliant System
 (ISA) 0x000000A2 (162)	Microsoft ACPI-Compliant System
 (ISA) 0x000000A3 (163)	Microsoft ACPI-Compliant System
 (ISA) 0x000000A4 (164)	Microsoft ACPI-Compliant System
 (ISA) 0x000000A5 (165)	Microsoft ACPI-Compliant System
 (ISA) 0x000000A6 (166)	Microsoft ACPI-Compliant System
 (ISA) 0x000000A7 (167)	Microsoft ACPI-Compliant System
 (ISA) 0x000000A8 (168)	Microsoft ACPI-Compliant System
 (ISA) 0x000000A9 (169)	Microsoft ACPI-Compliant System
 (ISA) 0x000000AA (170)	Microsoft ACPI-Compliant System
 (ISA) 0x000000AB (171)	Microsoft ACPI-Compliant System
 (ISA) 0x000000AC (172)	Microsoft ACPI-Compliant System
 (ISA) 0x000000AD (173)	Microsoft ACPI-Compliant System
 (ISA) 0x000000AE (174)	Microsoft ACPI-Compliant System
 (ISA) 0x000000AF (175)	Microsoft ACPI-Compliant System
 (ISA) 0x000000B0 (176)	Microsoft ACPI-Compliant System
 (ISA) 0x000000B1 (177)	Microsoft ACPI-Compliant System
 (ISA) 0x000000B2 (178)	Microsoft ACPI-Compliant System









































 (ISA) 0x00000B3 (179)	Microsoft ACPI-Compliant System
 (ISA) 0x00000B4 (180)	Microsoft ACPI-Compliant System
 (ISA) 0x00000B5 (181)	Microsoft ACPI-Compliant System
 (ISA) 0x00000B6 (182)	Microsoft ACPI-Compliant System
 (ISA) 0x00000B7 (183)	Microsoft ACPI-Compliant System
 (ISA) 0x00000B8 (184)	Microsoft ACPI-Compliant System
 (ISA) 0x00000B9 (185)	Microsoft ACPI-Compliant System
 (ISA) 0x00000BA (186)	Microsoft ACPI-Compliant System
 (ISA) 0x00000BB (187)	Microsoft ACPI-Compliant System
 (ISA) 0x00000BC (188)	Microsoft ACPI-Compliant System
 (ISA) 0x00000BD (189)	Microsoft ACPI-Compliant System
 (ISA) 0x00000BE (190)	Microsoft ACPI-Compliant System
 (ISA) 0x00000BF (191)	Microsoft ACPI-Compliant System
 (ISA) 0x00000C0 (192)	Microsoft ACPI-Compliant System
 (ISA) 0x00000C1 (193)	Microsoft ACPI-Compliant System
 (ISA) 0x00000C2 (194)	Microsoft ACPI-Compliant System
 (ISA) 0x00000C3 (195)	Microsoft ACPI-Compliant System
 (ISA) 0x00000C4 (196)	Microsoft ACPI-Compliant System
 (ISA) 0x00000C5 (197)	Microsoft ACPI-Compliant System
 (ISA) 0x00000C6 (198)	Microsoft ACPI-Compliant System
 (ISA) 0x00000C7 (199)	Microsoft ACPI-Compliant System
 (ISA) 0x00000C8 (200)	Microsoft ACPI-Compliant System
 (ISA) 0x00000C9 (201)	Microsoft ACPI-Compliant System
 (ISA) 0x00000CA (202)	Microsoft ACPI-Compliant System
 (ISA) 0x00000CB (203)	Microsoft ACPI-Compliant System
 (ISA) 0x00000CC (204)	Microsoft ACPI-Compliant System
 (ISA) 0x00000C100 (256)	Microsoft ACPI-Compliant System
 (ISA) 0x00000101 (257)	Microsoft ACPI-Compliant System
 (ISA) 0x00000102 (258)	Microsoft ACPI-Compliant System
 (ISA) 0x00000103 (259)	Microsoft ACPI-Compliant System
 (ISA) 0x00000104 (260)	Microsoft ACPI-Compliant System
 (ISA) 0x00000105 (261)	Microsoft ACPI-Compliant System
 (ISA) 0x00000106 (262)	Microsoft ACPI-Compliant System
 (ISA) 0x00000107 (263)	Microsoft ACPI-Compliant System
 (ISA) 0x00000108 (264)	Microsoft ACPI-Compliant System
 (ISA) 0x00000109 (265)	Microsoft ACPI-Compliant System
 (ISA) 0x0000010A (266)	Microsoft ACPI-Compliant System
 (ISA) 0x0000010B (267)	Microsoft ACPI-Compliant System
 (ISA) 0x0000010C (268)	Microsoft ACPI-Compliant System
 (ISA) 0x0000010D (269)	Microsoft ACPI-Compliant System
 (ISA) 0x0000010E (270)	Microsoft ACPI-Compliant System
 (ISA) 0x0000010F (271)	Microsoft ACPI-Compliant System
 (ISA) 0x00000110 (272)	Microsoft ACPI-Compliant System
 (ISA) 0x00000111 (273)	Microsoft ACPI-Compliant System
 (ISA) 0x00000112 (274)	Microsoft ACPI-Compliant System
 (ISA) 0x00000113 (275)	Microsoft ACPI-Compliant System
 (ISA) 0x00000114 (276)	Microsoft ACPI-Compliant System
 (ISA) 0x00000115 (277)	Microsoft ACPI-Compliant System
 (ISA) 0x00000116 (278)	Microsoft ACPI-Compliant System
 (ISA) 0x00000117 (279)	Microsoft ACPI-Compliant System
 (ISA) 0x00000118 (280)	Microsoft ACPI-Compliant System
 (ISA) 0x00000119 (281)	Microsoft ACPI-Compliant System

 (ISA) 0x0000011A (282)	Microsoft ACPI-Compliant System
 (ISA) 0x0000011B (283)	Microsoft ACPI-Compliant System
 (ISA) 0x0000011C (284)	Microsoft ACPI-Compliant System
 (ISA) 0x0000011D (285)	Microsoft ACPI-Compliant System
 (ISA) 0x0000011E (286)	Microsoft ACPI-Compliant System
 (ISA) 0x0000011F (287)	Microsoft ACPI-Compliant System
 (ISA) 0x00000120 (288)	Microsoft ACPI-Compliant System
 (ISA) 0x00000121 (289)	Microsoft ACPI-Compliant System
 (ISA) 0x00000122 (290)	Microsoft ACPI-Compliant System
 (ISA) 0x00000123 (291)	Microsoft ACPI-Compliant System
 (ISA) 0x00000124 (292)	Microsoft ACPI-Compliant System
 (ISA) 0x00000125 (293)	Microsoft ACPI-Compliant System
 (ISA) 0x00000126 (294)	Microsoft ACPI-Compliant System
 (ISA) 0x00000127 (295)	Microsoft ACPI-Compliant System
 (ISA) 0x00000128 (296)	Microsoft ACPI-Compliant System
 (ISA) 0x00000129 (297)	Microsoft ACPI-Compliant System
 (ISA) 0x0000012A (298)	Microsoft ACPI-Compliant System
 (ISA) 0x0000012B (299)	Microsoft ACPI-Compliant System
 (ISA) 0x0000012C (300)	Microsoft ACPI-Compliant System
 (ISA) 0x0000012D (301)	Microsoft ACPI-Compliant System
 (ISA) 0x0000012E (302)	Microsoft ACPI-Compliant System
 (ISA) 0x0000012F (303)	Microsoft ACPI-Compliant System
 (ISA) 0x00000130 (304)	Microsoft ACPI-Compliant System
 (ISA) 0x00000131 (305)	Microsoft ACPI-Compliant System
 (ISA) 0x00000132 (306)	Microsoft ACPI-Compliant System
 (ISA) 0x00000133 (307)	Microsoft ACPI-Compliant System
 (ISA) 0x00000134 (308)	Microsoft ACPI-Compliant System
 (ISA) 0x00000135 (309)	Microsoft ACPI-Compliant System
 (ISA) 0x00000136 (310)	Microsoft ACPI-Compliant System
 (ISA) 0x00000137 (311)	Microsoft ACPI-Compliant System
 (ISA) 0x00000138 (312)	Microsoft ACPI-Compliant System
 (ISA) 0x00000139 (313)	Microsoft ACPI-Compliant System
 (ISA) 0x0000013A (314)	Microsoft ACPI-Compliant System
 (ISA) 0x0000013B (315)	Microsoft ACPI-Compliant System
 (ISA) 0x0000013C (316)	Microsoft ACPI-Compliant System
 (ISA) 0x0000013D (317)	Microsoft ACPI-Compliant System
 (ISA) 0x0000013E (318)	Microsoft ACPI-Compliant System
 (ISA) 0x0000013F (319)	Microsoft ACPI-Compliant System
 (ISA) 0x00000140 (320)	Microsoft ACPI-Compliant System
 (ISA) 0x00000141 (321)	Microsoft ACPI-Compliant System
 (ISA) 0x00000142 (322)	Microsoft ACPI-Compliant System
 (ISA) 0x00000143 (323)	Microsoft ACPI-Compliant System
 (ISA) 0x00000144 (324)	Microsoft ACPI-Compliant System
 (ISA) 0x00000145 (325)	Microsoft ACPI-Compliant System
 (ISA) 0x00000146 (326)	Microsoft ACPI-Compliant System
 (ISA) 0x00000147 (327)	Microsoft ACPI-Compliant System
 (ISA) 0x00000148 (328)	Microsoft ACPI-Compliant System
 (ISA) 0x00000149 (329)	Microsoft ACPI-Compliant System
 (ISA) 0x0000014A (330)	Microsoft ACPI-Compliant System
 (ISA) 0x0000014B (331)	Microsoft ACPI-Compliant System
 (ISA) 0x0000014C (332)	Microsoft ACPI-Compliant System
 (ISA) 0x0000014D (333)	Microsoft ACPI-Compliant System

 (ISA) 0x0000014E (334)	Microsoft ACPI-Compliant System
 (ISA) 0x0000014F (335)	Microsoft ACPI-Compliant System
 (ISA) 0x00000150 (336)	Microsoft ACPI-Compliant System
 (ISA) 0x00000151 (337)	Microsoft ACPI-Compliant System
 (ISA) 0x00000152 (338)	Microsoft ACPI-Compliant System
 (ISA) 0x00000153 (339)	Microsoft ACPI-Compliant System
 (ISA) 0x00000154 (340)	Microsoft ACPI-Compliant System
 (ISA) 0x00000155 (341)	Microsoft ACPI-Compliant System
 (ISA) 0x00000156 (342)	Microsoft ACPI-Compliant System
 (ISA) 0x00000157 (343)	Microsoft ACPI-Compliant System
 (ISA) 0x00000158 (344)	Microsoft ACPI-Compliant System
 (ISA) 0x00000159 (345)	Microsoft ACPI-Compliant System
 (ISA) 0x0000015A (346)	Microsoft ACPI-Compliant System
 (ISA) 0x0000015B (347)	Microsoft ACPI-Compliant System
 (ISA) 0x0000015C (348)	Microsoft ACPI-Compliant System
 (ISA) 0x0000015D (349)	Microsoft ACPI-Compliant System
 (ISA) 0x0000015E (350)	Microsoft ACPI-Compliant System
 (ISA) 0x0000015F (351)	Microsoft ACPI-Compliant System
 (ISA) 0x00000160 (352)	Microsoft ACPI-Compliant System
 (ISA) 0x00000161 (353)	Microsoft ACPI-Compliant System
 (ISA) 0x00000162 (354)	Microsoft ACPI-Compliant System
 (ISA) 0x00000163 (355)	Microsoft ACPI-Compliant System
 (ISA) 0x00000164 (356)	Microsoft ACPI-Compliant System
 (ISA) 0x00000165 (357)	Microsoft ACPI-Compliant System
 (ISA) 0x00000166 (358)	Microsoft ACPI-Compliant System
 (ISA) 0x00000167 (359)	Microsoft ACPI-Compliant System
 (ISA) 0x00000168 (360)	Microsoft ACPI-Compliant System
 (ISA) 0x00000169 (361)	Microsoft ACPI-Compliant System
 (ISA) 0x0000016A (362)	Microsoft ACPI-Compliant System
 (ISA) 0x0000016B (363)	Microsoft ACPI-Compliant System
 (ISA) 0x0000016C (364)	Microsoft ACPI-Compliant System
 (ISA) 0x0000016D (365)	Microsoft ACPI-Compliant System
 (ISA) 0x0000016E (366)	Microsoft ACPI-Compliant System
 (ISA) 0x0000016F (367)	Microsoft ACPI-Compliant System
 (ISA) 0x00000170 (368)	Microsoft ACPI-Compliant System
 (ISA) 0x00000171 (369)	Microsoft ACPI-Compliant System
 (ISA) 0x00000172 (370)	Microsoft ACPI-Compliant System
 (ISA) 0x00000173 (371)	Microsoft ACPI-Compliant System
 (ISA) 0x00000174 (372)	Microsoft ACPI-Compliant System
 (ISA) 0x00000175 (373)	Microsoft ACPI-Compliant System
 (ISA) 0x00000176 (374)	Microsoft ACPI-Compliant System
 (ISA) 0x00000177 (375)	Microsoft ACPI-Compliant System
 (ISA) 0x00000178 (376)	Microsoft ACPI-Compliant System
 (ISA) 0x00000179 (377)	Microsoft ACPI-Compliant System
 (ISA) 0x0000017A (378)	Microsoft ACPI-Compliant System
 (ISA) 0x0000017B (379)	Microsoft ACPI-Compliant System
 (ISA) 0x0000017C (380)	Microsoft ACPI-Compliant System
 (ISA) 0x0000017D (381)	Microsoft ACPI-Compliant System
 (ISA) 0x0000017E (382)	Microsoft ACPI-Compliant System
 (ISA) 0x0000017F (383)	Microsoft ACPI-Compliant System
 (ISA) 0x00000180 (384)	Microsoft ACPI-Compliant System
 (ISA) 0x00000181 (385)	Microsoft ACPI-Compliant System

 (ISA) 0x00000182 (386)	Microsoft ACPI-Compliant System
 (ISA) 0x00000183 (387)	Microsoft ACPI-Compliant System
 (ISA) 0x00000184 (388)	Microsoft ACPI-Compliant System
 (ISA) 0x00000185 (389)	Microsoft ACPI-Compliant System
 (ISA) 0x00000186 (390)	Microsoft ACPI-Compliant System
 (ISA) 0x00000187 (391)	Microsoft ACPI-Compliant System
 (ISA) 0x00000188 (392)	Microsoft ACPI-Compliant System
 (ISA) 0x00000189 (393)	Microsoft ACPI-Compliant System
 (ISA) 0x0000018A (394)	Microsoft ACPI-Compliant System
 (ISA) 0x0000018B (395)	Microsoft ACPI-Compliant System
 (ISA) 0x0000018C (396)	Microsoft ACPI-Compliant System
 (ISA) 0x0000018D (397)	Microsoft ACPI-Compliant System
 (ISA) 0x0000018E (398)	Microsoft ACPI-Compliant System
 (ISA) 0x0000018F (399)	Microsoft ACPI-Compliant System
 (ISA) 0x00000190 (400)	Microsoft ACPI-Compliant System
 (ISA) 0x00000191 (401)	Microsoft ACPI-Compliant System
 (ISA) 0x00000192 (402)	Microsoft ACPI-Compliant System
 (ISA) 0x00000193 (403)	Microsoft ACPI-Compliant System
 (ISA) 0x00000194 (404)	Microsoft ACPI-Compliant System
 (ISA) 0x00000195 (405)	Microsoft ACPI-Compliant System
 (ISA) 0x00000196 (406)	Microsoft ACPI-Compliant System
 (ISA) 0x00000197 (407)	Microsoft ACPI-Compliant System
 (ISA) 0x00000198 (408)	Microsoft ACPI-Compliant System
 (ISA) 0x00000199 (409)	Microsoft ACPI-Compliant System
 (ISA) 0x0000019A (410)	Microsoft ACPI-Compliant System
 (ISA) 0x0000019B (411)	Microsoft ACPI-Compliant System
 (ISA) 0x0000019C (412)	Microsoft ACPI-Compliant System
 (ISA) 0x0000019D (413)	Microsoft ACPI-Compliant System
 (ISA) 0x0000019E (414)	Microsoft ACPI-Compliant System
 (ISA) 0x0000019F (415)	Microsoft ACPI-Compliant System
 (ISA) 0x000001A0 (416)	Microsoft ACPI-Compliant System
 (ISA) 0x000001A1 (417)	Microsoft ACPI-Compliant System
 (ISA) 0x000001A2 (418)	Microsoft ACPI-Compliant System
 (ISA) 0x000001A3 (419)	Microsoft ACPI-Compliant System
 (ISA) 0x000001A4 (420)	Microsoft ACPI-Compliant System
 (ISA) 0x000001A5 (421)	Microsoft ACPI-Compliant System
 (ISA) 0x000001A6 (422)	Microsoft ACPI-Compliant System
 (ISA) 0x000001A7 (423)	Microsoft ACPI-Compliant System
 (ISA) 0x000001A8 (424)	Microsoft ACPI-Compliant System
 (ISA) 0x000001A9 (425)	Microsoft ACPI-Compliant System
 (ISA) 0x000001AA (426)	Microsoft ACPI-Compliant System
 (ISA) 0x000001AB (427)	Microsoft ACPI-Compliant System
 (ISA) 0x000001AC (428)	Microsoft ACPI-Compliant System
 (ISA) 0x000001AD (429)	Microsoft ACPI-Compliant System
 (ISA) 0x000001AE (430)	Microsoft ACPI-Compliant System
 (ISA) 0x000001AF (431)	Microsoft ACPI-Compliant System
 (ISA) 0x000001B0 (432)	Microsoft ACPI-Compliant System
 (ISA) 0x000001B1 (433)	Microsoft ACPI-Compliant System
 (ISA) 0x000001B2 (434)	Microsoft ACPI-Compliant System
 (ISA) 0x000001B3 (435)	Microsoft ACPI-Compliant System
 (ISA) 0x000001B4 (436)	Microsoft ACPI-Compliant System
 (ISA) 0x000001B5 (437)	Microsoft ACPI-Compliant System

 (ISA) 0x000001B6 (438)	Microsoft ACPI-Compliant System
 (ISA) 0x000001B7 (439)	Microsoft ACPI-Compliant System
 (ISA) 0x000001B8 (440)	Microsoft ACPI-Compliant System
 (ISA) 0x000001B9 (441)	Microsoft ACPI-Compliant System
 (ISA) 0x000001BA (442)	Microsoft ACPI-Compliant System
 (ISA) 0x000001BB (443)	Microsoft ACPI-Compliant System
 (ISA) 0x000001BC (444)	Microsoft ACPI-Compliant System
 (ISA) 0x000001BD (445)	Microsoft ACPI-Compliant System
 (ISA) 0x000001BE (446)	Microsoft ACPI-Compliant System
 (ISA) 0x000001BF (447)	Microsoft ACPI-Compliant System
 (ISA) 0x000001C0 (448)	Microsoft ACPI-Compliant System
 (ISA) 0x000001C1 (449)	Microsoft ACPI-Compliant System
 (ISA) 0x000001C2 (450)	Microsoft ACPI-Compliant System
 (ISA) 0x000001C3 (451)	Microsoft ACPI-Compliant System
 (ISA) 0x000001C4 (452)	Microsoft ACPI-Compliant System
 (ISA) 0x000001C5 (453)	Microsoft ACPI-Compliant System
 (ISA) 0x000001C6 (454)	Microsoft ACPI-Compliant System
 (ISA) 0x000001C7 (455)	Microsoft ACPI-Compliant System
 (ISA) 0x000001C8 (456)	Microsoft ACPI-Compliant System
 (ISA) 0x000001C9 (457)	Microsoft ACPI-Compliant System
 (ISA) 0x000001CA (458)	Microsoft ACPI-Compliant System
 (ISA) 0x000001CB (459)	Microsoft ACPI-Compliant System
 (ISA) 0x000001CC (460)	Microsoft ACPI-Compliant System
 (ISA) 0x000001CD (461)	Microsoft ACPI-Compliant System
 (ISA) 0x000001CE (462)	Microsoft ACPI-Compliant System
 (ISA) 0x000001CF (463)	Microsoft ACPI-Compliant System
 (ISA) 0x000001D0 (464)	Microsoft ACPI-Compliant System
 (ISA) 0x000001D1 (465)	Microsoft ACPI-Compliant System
 (ISA) 0x000001D2 (466)	Microsoft ACPI-Compliant System
 (ISA) 0x000001D3 (467)	Microsoft ACPI-Compliant System
 (ISA) 0x000001D4 (468)	Microsoft ACPI-Compliant System
 (ISA) 0x000001D5 (469)	Microsoft ACPI-Compliant System
 (ISA) 0x000001D6 (470)	Microsoft ACPI-Compliant System
 (ISA) 0x000001D7 (471)	Microsoft ACPI-Compliant System
 (ISA) 0x000001D8 (472)	Microsoft ACPI-Compliant System
 (ISA) 0x000001D9 (473)	Microsoft ACPI-Compliant System
 (ISA) 0x000001DA (474)	Microsoft ACPI-Compliant System
 (ISA) 0x000001DB (475)	Microsoft ACPI-Compliant System
 (ISA) 0x000001DC (476)	Microsoft ACPI-Compliant System
 (ISA) 0x000001DD (477)	Microsoft ACPI-Compliant System
 (ISA) 0x000001DE (478)	Microsoft ACPI-Compliant System
 (ISA) 0x000001DF (479)	Microsoft ACPI-Compliant System
 (ISA) 0x000001E0 (480)	Microsoft ACPI-Compliant System
 (ISA) 0x000001E1 (481)	Microsoft ACPI-Compliant System
 (ISA) 0x000001E2 (482)	Microsoft ACPI-Compliant System
 (ISA) 0x000001E3 (483)	Microsoft ACPI-Compliant System
 (ISA) 0x000001E4 (484)	Microsoft ACPI-Compliant System
 (ISA) 0x000001E5 (485)	Microsoft ACPI-Compliant System
 (ISA) 0x000001E6 (486)	Microsoft ACPI-Compliant System
 (ISA) 0x000001E7 (487)	Microsoft ACPI-Compliant System
 (ISA) 0x000001E8 (488)	Microsoft ACPI-Compliant System
 (ISA) 0x000001E9 (489)	Microsoft ACPI-Compliant System

 (ISA) 0x000001EA (490)	Microsoft ACPI-Compliant System
 (ISA) 0x000001EB (491)	Microsoft ACPI-Compliant System
 (ISA) 0x000001EC (492)	Microsoft ACPI-Compliant System
 (ISA) 0x000001ED (493)	Microsoft ACPI-Compliant System
 (ISA) 0x000001EE (494)	Microsoft ACPI-Compliant System
 (ISA) 0x000001EF (495)	Microsoft ACPI-Compliant System
 (ISA) 0x000001F0 (496)	Microsoft ACPI-Compliant System
 (ISA) 0x000001F1 (497)	Microsoft ACPI-Compliant System
 (ISA) 0x000001F2 (498)	Microsoft ACPI-Compliant System
 (ISA) 0x000001F3 (499)	Microsoft ACPI-Compliant System
 (ISA) 0x000001F4 (500)	Microsoft ACPI-Compliant System
 (ISA) 0x000001F5 (501)	Microsoft ACPI-Compliant System
 (ISA) 0x000001F6 (502)	Microsoft ACPI-Compliant System
 (ISA) 0x000001F7 (503)	Microsoft ACPI-Compliant System
 (ISA) 0x000001F8 (504)	Microsoft ACPI-Compliant System
 (ISA) 0x000001F9 (505)	Microsoft ACPI-Compliant System
 (ISA) 0x000001FA (506)	Microsoft ACPI-Compliant System
 (ISA) 0x000001FB (507)	Microsoft ACPI-Compliant System
 (ISA) 0x000001FC (508)	Microsoft ACPI-Compliant System
 (ISA) 0x000001FD (509)	Microsoft ACPI-Compliant System
 (ISA) 0x000001FE (510)	Microsoft ACPI-Compliant System
 (ISA) 0x000001FF (511)	Microsoft ACPI-Compliant System
 (PCI) 0x00000019 (25)	High Definition Audio Controller
 (PCI) 0xFFFFFED (-19)	Intel(R) I211 Gigabit Network Connection #2
 (PCI) 0xFFFFFEE (-18)	Intel(R) I211 Gigabit Network Connection #2
 (PCI) 0xFFFFFEF (-17)	Intel(R) I211 Gigabit Network Connection #2
 (PCI) 0xFFFFFFF0 (-16)	Intel(R) I211 Gigabit Network Connection #2
 (PCI) 0xFFFFFFF1 (-15)	Intel(R) I211 Gigabit Network Connection #2
 (PCI) 0xFFFFFFF2 (-14)	Intel(R) I211 Gigabit Network Connection #2
 (PCI) 0xFFFFFFF3 (-13)	Intel(R) I211 Gigabit Network Connection
 (PCI) 0xFFFFFFF4 (-12)	Intel(R) I211 Gigabit Network Connection
 (PCI) 0xFFFFFFF5 (-11)	Intel(R) I211 Gigabit Network Connection
 (PCI) 0xFFFFFFF6 (-10)	Intel(R) I211 Gigabit Network Connection
 (PCI) 0xFFFFFFF7 (-9)	Intel(R) I211 Gigabit Network Connection
 (PCI) 0xFFFFFFF8 (-8)	Intel(R) I211 Gigabit Network Connection
 (PCI) 0xFFFFFFF9 (-7)	Intel(R) USB 3.0 eXtensible Host Controller - 1.0 (Microsoft)
 (PCI) 0xFFFFFFA (-6)	Intel(R) Trusted Execution Engine Interface
 (PCI) 0xFFFFF FB (-5)	Intel(R) HD Graphics
 (PCI) 0xFFFFF FC (-4)	Standard SATA AHCI Controller
 (PCI) 0xFFFFF FD (-3)	Intel(R) Celeron(R)/Pentium(R) Processor PCI Express Root Port - 5AD9
 (PCI) 0xFFFFF FE (-2)	Intel(R) Celeron(R)/Pentium(R) Processor PCI Express Root Port - 5AD8

Appendix C

Digital I/O Ports

C.1 Electrical Specifications for Digital I/O Ports

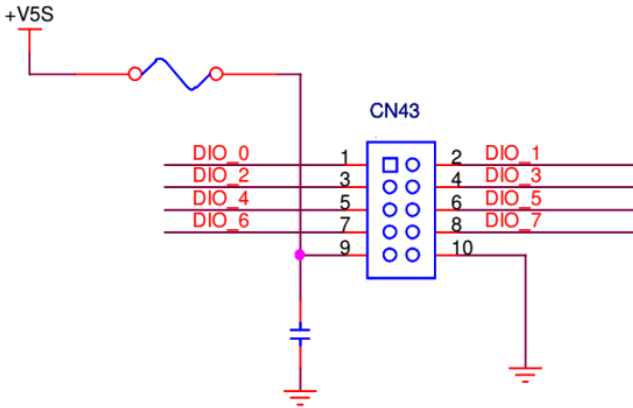

GPIO80	DIO_0
GPIO81	DIO_1
GPIO82	DIO_2
GPIO83	DIO_3
GPIO84	DIO_4
GPIO85	DIO_5
GPIO86	DIO_6
GPIO87	DIO_7

C.2 DIO Programming

The BOXER-6616 utilizes FINTEK F81966 chipset as its Digital I/O controller. Below are the procedures to complete its configuration. AAEON initial DI/O program is also attached for developing customized program for your application.

There are three steps to complete the configuration setup:

- (1) Enter the MB PnP Mode
- (2) Modify the data of configuration registers
- (3) Exit the MB PnP Mode. Undesired result may occur if the MB PnP Mode is not exited normally.

C.3 Digital I/O Register

Table 1 : SuperIO relative register table		
	Default Value	Note
Index	0x2E(Note1)	SIO MB PnP Mode Index Register 0x2E or 0x4E
Data	0x2F(Note2)	SIO MB PnP Mode Data Register 0x2F or 0x4F

Table 2 : Digital Input relative register table					
	LDN	Register	BitNum	Value	Note
DIO-1 Pin Status	0x06(Note3)	0x8A(Note4)	0(Note5)		GPIO80
DIO-2 Pin Status	0x06(Note6)	0x8A (Note7)	1(Note8)		GPIO81
DIO-3 Pin Status	0x06(Note9)	0x8A(Note10)	2(Note11)		GPIO82
DIO-4 Pin Status	0x06(Note12)	0x8A(Note13)	3(Note14)		GPIO83
DIO-5 Pin Status	0x06(Note15)	0x8A(Note16)	4(Note17)		GPIO84
DIO-6 Pin Status	0x06(Note18)	0x8A(Note19)	5(Note20)		GPIO85
DIO-7 Pin Status	0x06(Note21)	0x8A(Note22)	6(Note23)		GPIO86
DIO-8 Pin Status	0x06(Note24)	0x8A(Note25)	7(Note26)		GPIO87

Table 3 : Digital Output relative register table					
	LDN	Register	BitNum	Value	Note
DIO-1 Output Data	0x06(Note27)	0x89(Note28)	0(Note29)	(Note30)	GPIO80
DIO-2 Output Data	0x06(Note31)	0x89(Note32)	1(Note33)	(Note34)	GPIO81
DIO-3 Output Data	0x06(Note35)	0x89(Note36)	2(Note37)	(Note38)	GPIO82
DIO-4 Output Data	0x06(Note39)	0x89(Note40)	3(Note41)	(Note42)	GPIO83
DIO-5 Output Data	0x06(Note43)	0x89(Note44)	4(Note45)	(Note46)	GPIO84
DIO-6 Output Data	0x06(Note47)	0x89(Note48)	5(Note49)	(Note50)	GPIO85
DIO-7 Output Data	0x06(Note51)	0x89(Note52)	6(Note53)	(Note54)	GPIO86
DIO-8 Output Data	0x06(Note55)	0x89(Note56)	7(Note57)	(Note58)	GPIO87

C.4 Digital I/O Sample Program

```
*****
// SuperIO relative definition (Please reference to Table 1)
#define byte SIOIndex //This parameter is represented from Note1
#define byte SIOData //This parameter is represented from Note2
#define void IOWriteByte(byte IOPort, byte Value);
#define byte IOReadByte(byte IOPort);
// Digital Input Status relative definition (Please reference to Table 2)
#define byte DInput1LDN // This parameter is represented from Note3
#define byte DInput1Reg // This parameter is represented from Note4
#define byte DInput1Bit // This parameter is represented from Note5
#define byte DInput2LDN // This parameter is represented from Note6
#define byte DInput2Reg // This parameter is represented from Note7
#define byte DInput2Bit // This parameter is represented from Note8
#define byte DInput3LDN // This parameter is represented from Note9
#define byte DInput3Reg // This parameter is represented from Note10
#define byte DInput3Bit // This parameter is represented from Note11
#define byte DInput4LDN // This parameter is represented from Note12
#define byte DInput4Reg // This parameter is represented from Note13
#define byte DInput4Bit // This parameter is represented from Note14
#define byte DInput5LDN // This parameter is represented from Note15
#define byte DInput5Reg // This parameter is represented from Note16
#define byte DInput5Bit // This parameter is represented from Note17
#define byte DInput6LDN // This parameter is represented from Note18
#define byte DInput6Reg // This parameter is represented from Note19
#define byte DInput6Bit // This parameter is represented from Note20
#define byte DInput7LDN // This parameter is represented from Note21
#define byte DInput7Reg // This parameter is represented from Note22
#define byte DInput7Bit // This parameter is represented from Note23
#define byte DInput8LDN // This parameter is represented from Note24
#define byte DInput8Reg // This parameter is represented from Note25
#define byte DInput8Bit // This parameter is represented from Note26
*****
```

```

*****
// Digital Output control relative definition (Please reference to Table 3)
#define byte DOutput1LDN // This parameter is represented from Note27
#define byte DOutput1Reg // This parameter is represented from Note28
#define byte DOutput1Bit // This parameter is represented from Note29
#define byte DOutput1Val // This parameter is represented from Note30
#define byte DOutput2LDN // This parameter is represented from Note31
#define byte DOutput2Reg // This parameter is represented from Note32
#define byte DOutput2Bit // This parameter is represented from Note33
#define byte DOutput2Val // This parameter is represented from Note34
#define byte DOutput3LDN // This parameter is represented from Note35
#define byte DOutput3Reg // This parameter is represented from Note36
#define byte DOutput3Bit // This parameter is represented from Note37
#define byte DOutput3Val // This parameter is represented from Note38
#define byte DOutput4LDN // This parameter is represented from Note39
#define byte DOutput4Reg // This parameter is represented from Note40
#define byte DOutput4Bit // This parameter is represented from Note41
#define byte DOutput4Val // This parameter is represented from Note42
#define byte DOutput5LDN // This parameter is represented from Note43
#define byte DOutput5Reg // This parameter is represented from Note44
#define byte DOutput5Bit // This parameter is represented from Note45
#define byte DOutput5Val // This parameter is represented from Note46
#define byte DOutput6LDN // This parameter is represented from Note47
#define byte DOutput6Reg // This parameter is represented from Note48
#define byte DOutput6Bit // This parameter is represented from Note49
#define byte DOutput6Val // This parameter is represented from Note50
#define byte DOutput7LDN // This parameter is represented from Note51
#define byte DOutput7Reg // This parameter is represented from Note52
#define byte DOutput7Bit // This parameter is represented from Note53
#define byte DOutput7Val // This parameter is represented from Note54
#define byte DOutput8LDN // This parameter is represented from Note55
#define byte DOutput8Reg // This parameter is represented from Note56
#define byte DOutput8Bit // This parameter is represented from Note57
#define byte DOutput8Val // This parameter is represented from Note58
*****

```

```
*****
VOID Main(){
    Boolean PinStatus ;

    // Procedure : AaeonReadPinStatus
    // Input :
    //     Example, Read Digital I/O Pin 3 status
    // Output :
    //     InputStatus :
    //         0: Digital I/O Pin level is low
    //         1: Digital I/O Pin level is High
    PinStatus = AaeonReadPinStatus(DInput3LDN, DInput3Reg, DInput3Bit);

    // Procedure : AaeonSetOutputLevel
    // Input :
    //     Example, Set Digital I/O Pin 6 level
    AaeonSetOutputLevel(DOutput6LDN, DOutput6Reg, DOutput6Bit,
DOutput6Val);
}
*****
```

```
*****
Boolean  AaeonReadPinStatus(byte LDN, byte Register, byte BitNum){
    Boolean PinStatus ;

    PinStatus = SIOBitRead(LDN, Register, BitNum);
    Return PinStatus ;
}
VOID  AaeonSetOutputLevel(byte LDN, byte Register, byte BitNum, byte Value){
    ConfigToOutputMode(LDN, Register, BitNum);
    SIOBitSet(LDN, Register, BitNum, Value);
}
*****
```

```

*****
VOID  SIOEnterMBPnPMode(){
    IOWriteByte(SIOIndex, 0x87);
    IOWriteByte(SIOIndex, 0x87);
}

VOID  SIOExitMBPnPMode(){
    IOWriteByte(SIOIndex, 0xAA);
}

VOID  SIOSelectLDN(byte LDN){
    IOWriteByte(SIOIndex, 0x07); // SIO LDN Register Offset = 0x07
    IOWriteByte(SIOData, LDN);
}

VOID  SIOBitSet(byte LDN, byte Register, byte BitNum, byte Value){
    Byte TmpValue;

    SIOEnterMBPnPMode();
    SIOSelectLDN(byte LDN);
    IOWriteByte(SIOIndex, Register);
    TmpValue = IOReadByte(SIOData);
    TmpValue &= ~(1 << BitNum);
    TmpValue |= (Value << BitNum);
    IOWriteByte(SIOData, TmpValue);
    SIOExitMBPnPMode();
}

VOID  SIOByteSet(byte LDN, byte Register, byte Value){
    SIOEnterMBPnPMode();
    SIOSelectLDN(LDN);
    IOWriteByte(SIOIndex, Register);
    IOWriteByte(SIOData, Value);
    SIOExitMBPnPMode();
}
*****

```

```

*****
Boolean  SIOBitRead(byte LDN, byte Register, byte BitNum){
    Byte TmpValue;

    SIOEnterMBPnPMode();
    SIOSelectLDN(LDN);
    IOWriteByte(SIOIndex, Register);
    TmpValue = IOReadByte(SIOData);
    TmpValue &= (1 << BitNum);
    SIOExitMBPnPMode();
    If(TmpValue == 0)
        Return 0;
    Return 1;
}
VOID  ConfigToOutputMode(byte LDN, byte Register, byte BitNum){
    Byte TmpValue, OutputEnableReg;

    OutputEnableReg = Register-1;
    SIOEnterMBPnPMode();
    SIOSelectLDN(LDN);
    IOWriteByte(SIOIndex, OutputEnableReg);
    TmpValue = IOReadByte(SIOData);
    TmpValue |= (1 << BitNum);
    IOWriteByte(SIOData, OutputEnableReg);
    SIOExitMBPnPMode();
}
*****

```