

# BOXER-6614

---

Fanless Embedded Box PC

User's Manual 2<sup>nd</sup> Ed

## Copyright Notice

---

This document is copyrighted, 2015. All rights are reserved. The original manufacturer reserves the right to make improvements to the products described in this manual at any time without notice.

No part of this manual may be reproduced, copied, translated, or transmitted in any form or by any means without the prior written permission of the original manufacturer. Information provided in this manual is intended to be accurate and reliable. However, the original manufacturer assumes no responsibility for its use, or for any infringements upon the rights of third parties that may result from its use.

The material in this document is for product information only and is subject to change without notice. While reasonable efforts have been made in the preparation of this document to assure its accuracy, AAEMON assumes no liabilities resulting from errors or omissions in this document, or from the use of the information contained herein.

AAEMON reserves the right to make changes in the product design without notice to its users.

## Acknowledgement

---

All other products' name or trademarks are properties of their respective owners.

- Microsoft Windows® is a registered trademark of Microsoft Corp.
- Intel®, Platium®, Celeron®, and Xeon® are registered trademarks of Intel Corporation
- Atom™ is a trademark of Intel Corporation
- ITE is a trademark of Integrated Technology Express, Inc.
- IBM, PC/AT, PS/2, and VGA are trademarks of International Business Machines Corporation.

All other product names or trademarks are properties of their respective owners.

## Packing List

---

Before setting up your product, please make sure the following items have been shipped:

Item	Quantity
● BOXER-6614	1
● Wallmount bracket	2
● Screw Package	1
● Thermal Pad (A1/A1M)	1
● Phoenix power connector	1
● Product CD with User's Manual (in pdf) and drivers	1

If any of these items are missing or damaged, please contact your distributor or sales representative immediately.

## About this Document

---

This User's Manual contains all the essential information, such as detailed descriptions and explanations on the product's hardware and software features (if any), its specifications, dimensions, jumper/connector settings/definitions, and driver installation instructions (if any), to facilitate users in setting up their product.

Users may refer to the [AAEON.com](http://AAEON.com) for the latest version of this document.

## Safety Precautions

---

Please read the following safety instructions carefully. It is advised that you keep this manual for future references

1. All cautions and warnings on the device should be noted.
2. Make sure the power source matches the power rating of the device.
3. Position the power cord so that people cannot step on it. Do not place anything over the power cord.
4. Always completely disconnect the power before working on the system's hardware.
5. No connections should be made when the system is powered as a sudden rush of power may damage sensitive electronic components.
6. If the device is not to be used for a long time, disconnect it from the power supply to avoid damage by transient over-voltage.
7. Always disconnect this device from any AC supply before cleaning.
8. While cleaning, use a damp cloth instead of liquid or spray detergents.
9. Make sure the device is installed near a power outlet and is easily accessible.
10. Keep this device away from humidity.
11. Place the device on a solid surface during installation to prevent falls
12. Do not cover the openings on the device to ensure optimal heat dissipation.
13. Watch out for high temperatures when the system is running.
14. Do not touch the heat sink or heat spreader when the system is running
15. Never pour any liquid into the openings. This could cause fire or electric shock.
16. As most electronic components are sensitive to static electrical charge, be sure to ground yourself to prevent static charge when installing the internal components. Use a grounding wrist strap and contain all electronic components in any static-shielded containers.

17. If any of the following situations arises, please the contact our service personnel:
  - i. Damaged power cord or plug
  - ii. Liquid intrusion to the device
  - iii. Exposure to moisture
  - iv. Device is not working as expected or in a manner as described in this manual
  - v. The device is dropped or damaged
  - vi. Any obvious signs of damage displayed on the device
18. **DO NOT LEAVE THIS DEVICE IN AN UNCONTROLLED ENVIRONMENT WITH TEMPERATURES BEYOND THE DEVICE'S PERMITTED STORAGE TEMPERATURES (SEE CHAPTER 1) TO PREVENT DAMAGE.**

### **Warning!**



This device complies with Part 15 FCC Rules. Operation is subject to the following two conditions: (1) this device may not cause harmful interference, and (2) this device must accept any interference received including interference that may cause undesired operation.

### **Caution:**

*There is a danger of explosion if the battery is incorrectly replaced. Replace only with the same or equivalent type recommended by the manufacturer. Dispose of used batteries according to the manufacturer's instructions and your local government's recycling or disposal directives.*

### **Attention:**

*Il y a un risque d'explosion si la batterie est remplacée de façon incorrecte. Ne la remplacer qu'avec le même modèle ou équivalent recommandé par le constructeur. Recycler les batteries usées en accord avec les instructions du fabricant et les directives gouvernementales de recyclage.*



## China RoHS Requirements (CN)

产品中有毒有害物质或元素名称及含量

AAEON Embedded Box PC/ Industrial System

部件名称	有毒有害物质或元素					
	铅 (Pb)	汞 (Hg)	镉 (Cd)	六价铬 (Cr(VI))	多溴联苯 (PBB)	多溴二苯醚 (PBDE)
印刷电路板 及其电子组件	○	○	○	○	○	○
外部信号 连接器及线材	○	○	○	○	○	○
外壳	○	○	○	○	○	○
中央处理器 与内存	○	○	○	○	○	○
硬盘	○	○	○	○	○	○
电源	○	○	○	○	○	○
<p>○：表示该有毒有害物质在该部件所有均质材料中的含量均在 SJ/T 11363-2006 标准规定的限量要求以下。</p> <p>X：表示该有毒有害物质至少在该部件的某一均质材料中的含量超出 SJ/T 11363-2006 标准规定的限量要求。</p> <p>备注： 一、此产品所标示之环保使用期限，系指在一般正常使用状况下。 二、上述部件物质中央处理器、内存、硬盘、电源为选购品。</p>						

## China RoHS Requirement (EN)

Poisonous or Hazardous Substances or Elements in Products  
 AAEON Embedded Box PC/ Industrial System

Component	Poisonous or Hazardous Substances or Elements					
	Lead (Pb)	Mercury (Hg)	Cadmium (Cd)	Hexavalent Chromium (Cr(VI))	Polybrominated Biphenyls (PBB)	Polybrominated Diphenyl Ethers (PBDE)
PCB & Other Components	○	○	○	○	○	○
Wires & Connectors for External Connections	○	○	○	○	○	○
Chassis	○	○	○	○	○	○
CPU & RAM	○	○	○	○	○	○
Hard Disk	○	○	○	○	○	○
PSU	○	○	○	○	○	○
<p>O: The quantity of poisonous or hazardous substances or elements found in each of the component's parts is below the SJ/T 11363-2006-stipulated requirement.</p> <p>X: The quantity of poisonous or hazardous substances or elements found in at least one of the component's parts is beyond the SJ/T 11363-2006-stipulated requirement.</p> <p><b>Note: The Environment Friendly Use Period as labeled on this product is applicable under normal usage only</b></p>						

# Table of Contents

---

- Chapter 1 - Product Specifications..... 1
  - 1.1 Specifications..... 2
- Chapter 2 – Hardware Information ..... 5
  - 2.1 Dimensions ..... 6
  - 2.2 Jumpers and Connectors ..... 10
  - 2.3 List of Jumpers ..... 13
    - 2.3.1 COM2 Pin8 Function Selection (JP8) ..... 14
    - 2.3.2 COM3 Pin8 Function Selection (JP9) ..... 14
    - 2.3.3 Auto Power Button Enable/Disable Selection (JP17)..... 14
    - 2.3.4 Clear CMOS Jumper (JP21) ..... 14
  - 2.4 List of Connectors ..... 15
    - 2.4.1 +5VSB Output w/SMBus (CN1) ..... 17
    - 2.4.2 +5V Output for SATA HDD (CN4) ..... 17
    - 2.4.3 External +5VSB Input (CN5) ..... 17
    - 2.4.4 SATA Port1 (CN6)..... 18
    - 2.4.5 External +12V Input (CN7) ..... 18
    - 2.4.6 Audio I/O Port (CN9) ..... 19
    - 2.4.7 MiniCard Slot (Half-MiniCard) (CN10) ..... 19
    - 2.4.8 LPC Port (CN11)..... 22
    - 2.4.9 COM Port 2 Connector (CN12 of mainboard) ..... 22
    - 2.4.10 LPT Port (CN13) ..... 24
    - 2.4.11 COM Port 3 Connector (CN14 of mainboard) ..... 25
    - 2.4.12 COM Port 4 (CN15 of mainboard)..... 26
    - 2.4.13 Digital IO Port (CN16)..... 26
    - 2.4.14 USB 2.0 Port 3 (CN17) ..... 27
    - 2.4.15 USB 2.0 Port 2 (CN18)..... 28

2.4.16	USB Port 2 and 3 (CN17/18) .....	28
2.4.17	BIOS Debug Port (CN19) .....	29
2.4.18	PS/2 Keyboard/Mouse Combo Port (CN22).....	29
2.4.19	USB Ports 0 and 1 (CN25).....	30
2.4.20	LAN (RJ-45) Port1 (CN26).....	31
2.4.21	LAN (RJ-45) Port2 (CN27).....	31
2.4.22	COM Port 1 (D-SUB 9) (CN28) .....	32
2.4.23	HDMI Port (CN29) .....	32
2.4.24	VGA Port (CN30).....	33
2.4.25	Battery (CN31).....	34
2.4.26	CFast Slot (CN33).....	34
2.4.27	DDR3L SO-DIMM Slot (CN34).....	35
2.4.28	UIM Card Socket (CN35).....	35
2.4.29	MiniCard Slot (Full-MiniCard) (CN37).....	36
2.5	Hard Disk Drive Installation (A2/A2M) .....	39
2.6	RAM Installation (A1/A1M).....	41
2.7	RAM Installation (A2/A2M).....	46
2.8	CFast™ Installation (A1/A1M/A2/A2M) .....	48
2.9	Wallmount Installation.....	49
<b>Chapter 3 - AMI BIOS Setup.....</b>		<b>50</b>
3.1	System Test and Initialization .....	51
3.2	AMI BIOS Setup.....	52
3.3	Setup Submenu: Main.....	53
3.4	Setup Submenu: Advanced .....	54
3.4.1	Advanced: Power Management.....	55
3.4.1.1	Power Management: S5 RTC Wake Settings.....	57
3.4.2	Advanced: Super IO Configuration.....	58
3.4.2.1	Super IO Configuration: Serial Port 1 Configuration.	59

3.4.2.2	Super IO Configuration: Serial Port 2 Configuration.	60
3.4.2.3	Super IO Configuration: Serial Port 3 Configuration.	61
3.4.2.4	Super IO Configuration: Serial Port 4 Configuration.	62
3.4.3	Advanced: H/W Monitor .....	65
3.4.4	Advanced: CPU Configuration.....	66
3.4.4.1	CPU Configuration: Socket 0 CPU Configuration .....	67
3.4.5	Advanced: SATA Configuration.....	68
3.4.6	Advanced: CSM Configuration .....	69
3.4.7	Advanced: Trusted Computing .....	70
3.4.8	Advanced: USB Configuration .....	71
3.5	Setup submenu: Chipset.....	73
3.5.1	Chipset: Host Bridge .....	74
3.5.2	Chipset: South Bridge .....	75
3.5.2.1	South Bridge: Azalia HD Audio.....	76
3.5.2.2	South Bridge: USB Configuration .....	77
3.5.2.3	South Bridge: PCI Express Configuration.....	78
3.6	Setup submenu: Security .....	79
3.7	Setup submenu: Boot.....	80
3.8	Setup submenu: Save & Exit.....	81
<b>Chapter 4 – Drivers Installation .....</b>		<b>82</b>
4.1	Product CD/DVD.....	83
<b>Appendix A - Watchdog Timer Programming.....</b>		<b>93</b>
A.1	Watchdog Timer Registers .....	94
A.2	Watchdog Sample Program .....	96
<b>Appendix B - I/O Information .....</b>		<b>98</b>
B.1	I/O Address Map.....	99
B.2	Memory Address Map .....	100
B.3	IRQ Mapping Chart .....	101

B.4 DMA Channel Assignments ..... 104

# Chapter 1

---

Product Specifications

## 1.1 Specifications

---

### System

- **Processor** Intel® Celeron® SoC N2930 1.83GHz
- **System Memory** DDR3L 1333 SODIMM x 1, up to 8 GB
- **Display** VGA x 1  
HDMI x 1
- **Ethernet** Gigabit Ethernet, RJ-45 x 2  
MiniCard wireless module (optional)
- **Storage** SATA 3.0Gb/s 2.5" HDD/SSD Bay x 1  
CFast™ Slot x 1 (with cover)
- **Serial Port** RS-232/422/485 x 2  
RS-232 x 2
- **USB** USB 3.0 x 1  
USB 2.0 x 3
- **System Control** Power ON/OFF
- **LED Indicator** Power LED x 1  
Hard disk active LED x 1  
Link status x 2  
Activate status x 2
- **Expansion Slot** Full-size Mini Card Slot x 1  
Half-size Mini Card x 1 (only for factory-install)  
SIM Slot x 1
- **OS Support** Windows® 8.1 (32/64-bit)  
Windows® 7(32/64-bit)  
WES7/WES8  
Linux Fedora Core



## Mechanical

- **Construction** Rugged aluminum chassis
- **Mounting** Desktop  
Wallmount  
DIN rail
- **Dimension (W x H x D)** 221.15 x 84.28 x 107mm (8.71 x 3.32 x 2.25")
- **Gross Weight** 2.8 kg (6.16 lb)
- **Net Weight** 2.0 kg (4.4 lb)

## Environmental

- **Operating Temperature** Ambient with Airflow  
-20 ~ 55°C (-4 ~ 131°F) - CFast™  
-20 ~ 60°C (-4 ~ 140°F) - HDD  
With industrial grade device  
(according to IEC68-2-14)
- **Storage Temperature** -20 ~ 70°C (-4 ~ 158°F)  
With industrial grade device  
(according to IEC62-2-1, IEC68-2-2)
- **Storage Humidity** 95% @ 40°C, non-condensing
- **Anti-Vibration** 5 Grms/ 5~500Hz/ operation – CFast™  
1 Grms/ 5~500Hz/ operation – HDD
- **Anti-Shock** 50 G peak acceleration (11msec. duration) – CFast™  
20 G peak acceleration (11msec. duration) – HDD
- **EMC** CE/FCC Class A

## Power Supply

- **DC Input**
  - A1/A2 - DC power input 12V
  - A1M/A2M - DC 9-30V w/ 3-pin terminal block

# Chapter 2

---

Hardware Information



# Model A1M

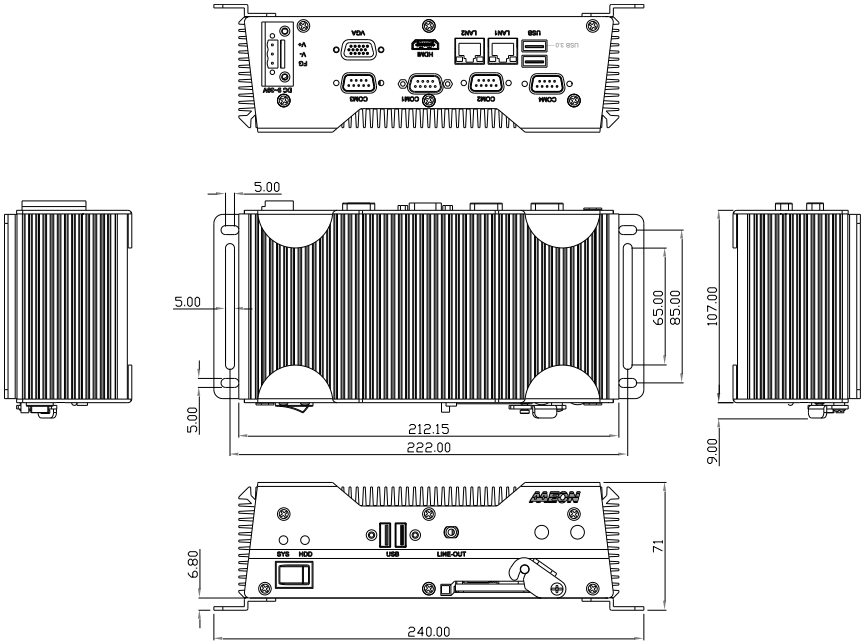

# Model A2

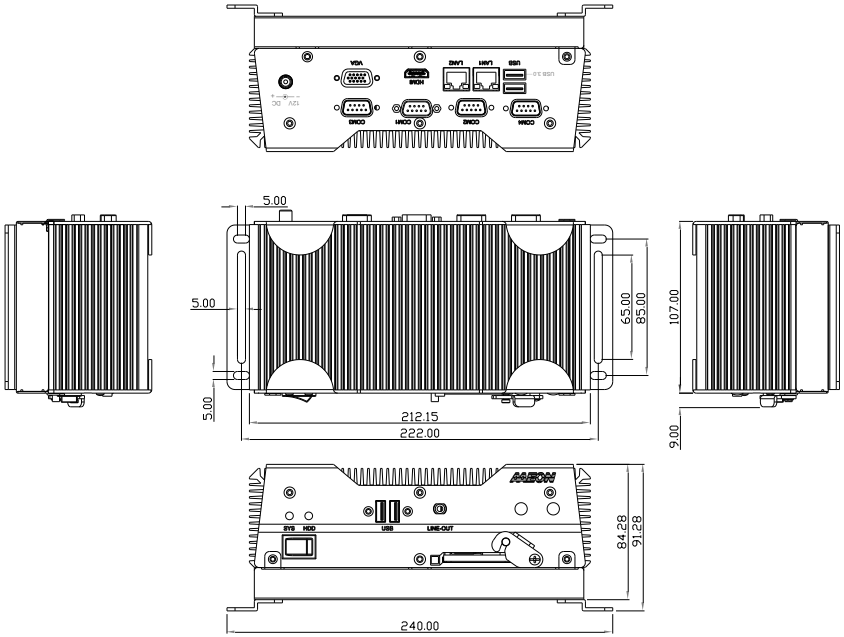

# Model A2M

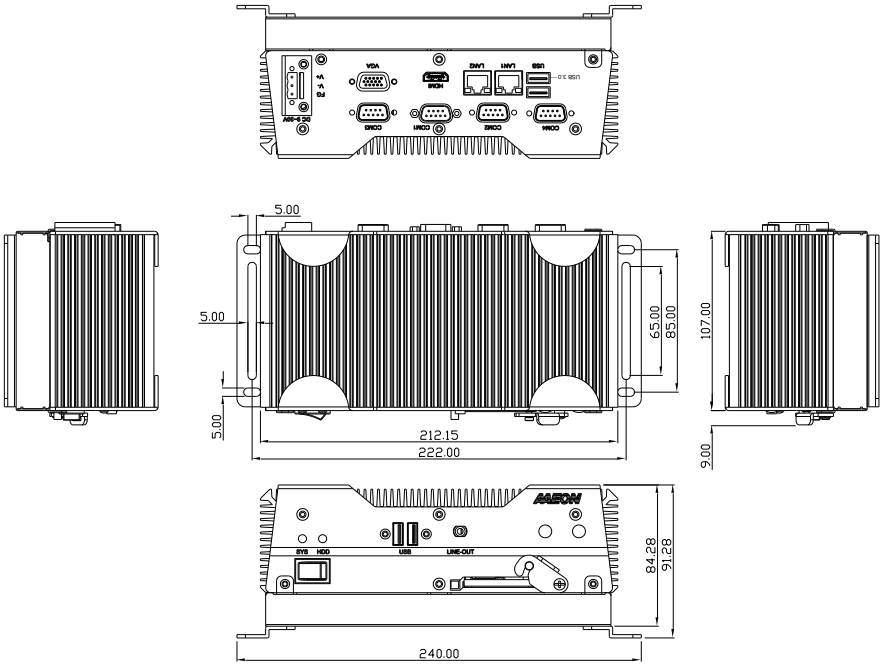

## 2.2 Jumpers and Connectors

### Component Side

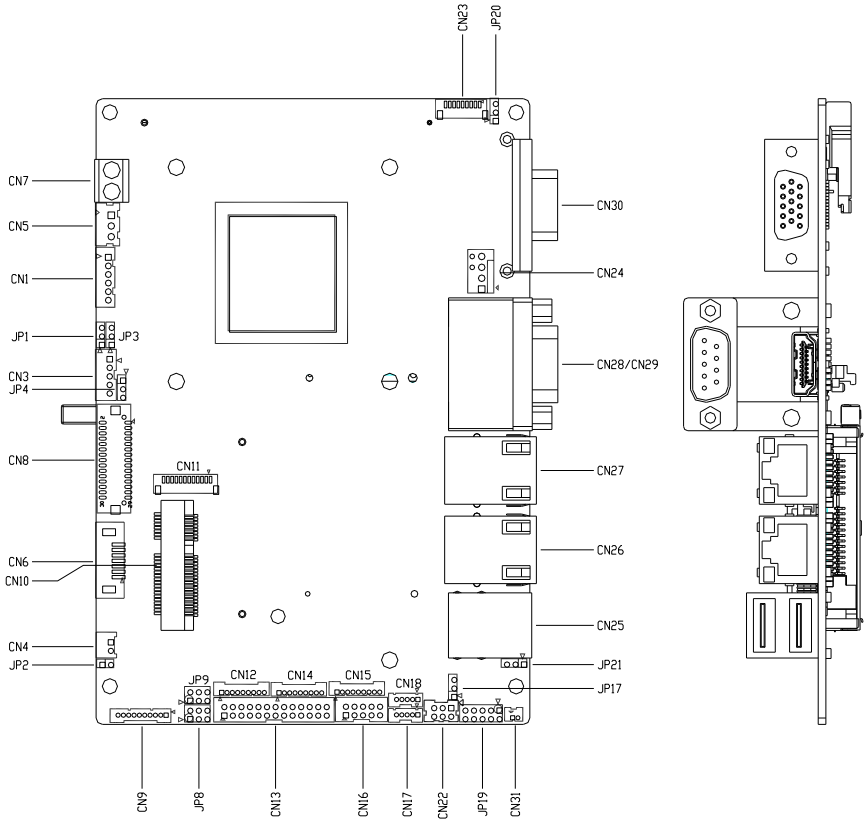



Solder Side

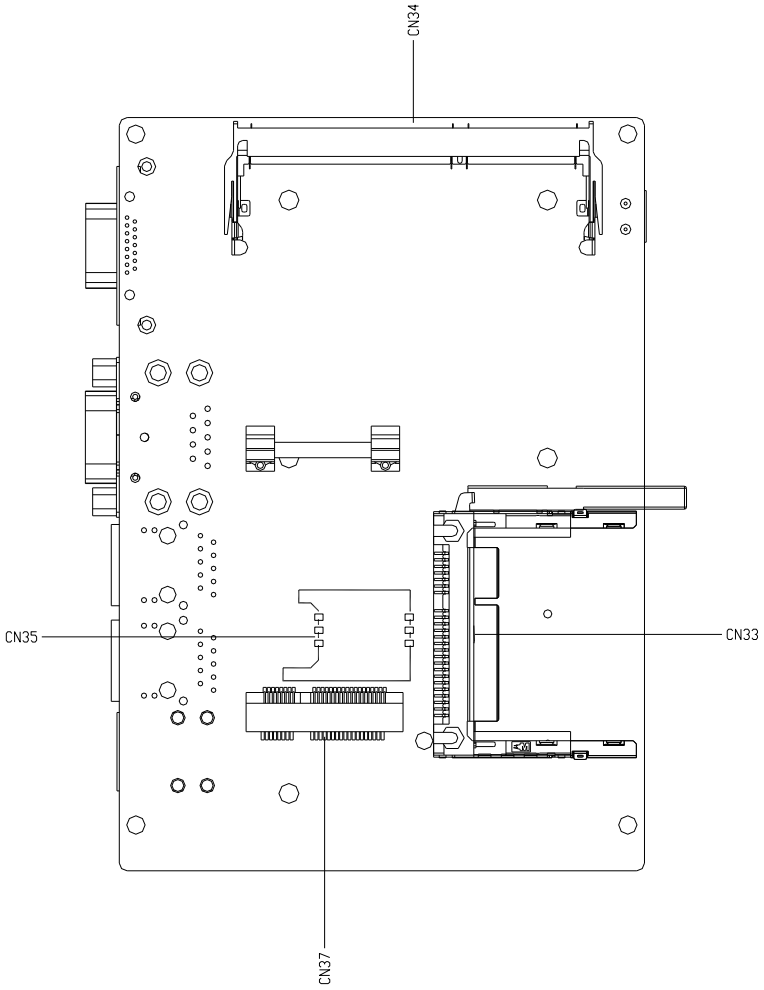

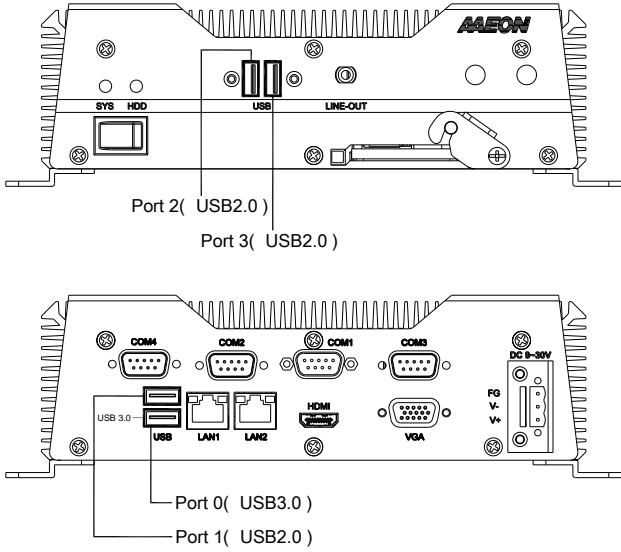

## 2.3 List of Jumpers

---

Please refer to the table below for all of the system's jumpers that you can configure for your application

Label	Function
JP8	COM2 Pin8 Function Selection
JP9	COM3 Pin8 Function Selection
JP17	Auto Power Button Enable/Disable Selection
JP21	Clear CMOS Jumper

### 2.3.1 COM2 Pin8 Function Selection (JP8)

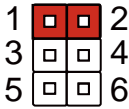

+12V

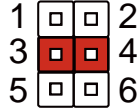

Ring(Default)

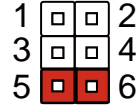

+5V

### 2.3.2 COM3 Pin8 Function Selection (JP9)

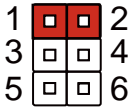

+12V

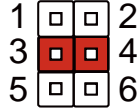

Ring(Default)

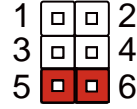

+5V

### 2.3.3 Auto Power Button Enable/Disable Selection (JP17)



Disable

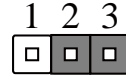

Enable (Default)

**Note:** When disabled, use JP19 (1-2) to power on the system

### 2.3.4 Clear CMOS Jumper (JP21)

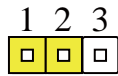

Normal (Default)

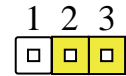

Clear CMOS

## 2.4 List of Connectors

---

Please refer to the table below for all of the system's connectors that you can configure for your application

Label	Function
CN1	+5VSB Output w/SMBus
CN4	+5V Output for SATA HDD
CN6	SATA Port
CN7	External +12V Input
CN9	Audio I/O Port
CN10	MiniCard Slot (Half-MiniCard)
CN11	LPC Port
CN12	COM Port 2 Connector
CN13	LPT Port
CN14	COM Port 3 Connector
CN15	COM Port 4 Connector
CN16	Digital IO Port
CN17	USB 2.0 Port 3
CN18	USB 2.0 Port 2
CN19	SPI Debug Port
CN22	PS/2 Keyboard/Mouse Combo Port
CN25	USB Ports 0 and 1
CN26	LAN (RJ-45) Port1
CN27	LAN (RJ-45) Port2
CN28	COM Port 1 Connector (D-SUB 9)
CN29	HDMI Port
CN30	VGA Port
CN31	Battery

CN33	CFast Slot
CN34	DDR3L SO-DIMM Slot
CN35	UIM Card Socket
CN37	MiniCard Slot (Full-MiniCard)

### 2.4.1 +5VSB Output w/SMBus (CN1)

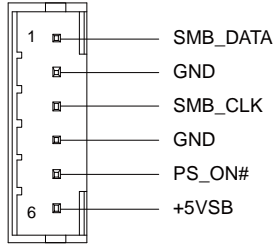

Pin	Pin name	Signal Type	Signal Level
1	SMB_DATA	I/O	+3.3V
2	GND	GND	
3	SMB_CLK	I/O	+3.3V
4	GND	GND	
5	PS_ON#	OUT	+3.3V
6	+5VSB	PWR	+5V

### 2.4.2 +5V Output for SATA HDD (CN4)

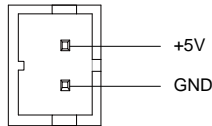

Pin	Pin name	Signal Type	Signal Level
1	+5V	PWR	+5V
2	GND	GND	

### 2.4.3 External +5VSB Input (CN5)

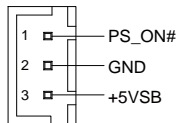

Pin	Pin name	Signal Type	Signal Level
1	PS_ON#	OUT	+3.3V
2	GND	GND	
3	+5VSB	PWR	+5V

#### 2.4.4 SATA Port1 (CN6)

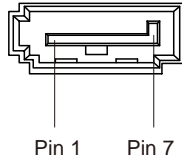

Pin	Pin name	Signal Type	Signal Level
1	GND	GND	
2	SATA_TX+	DIFF	
3	SATA_TX-	DIFF	
4	GND	GND	
5	SATA_RX-	DIFF	
6	SATA_RX+	DIFF	
7	GND	GND	

#### 2.4.5 External +12V Input (CN7)

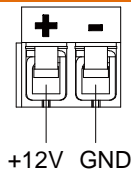

Pin	Pin name	Signal Type	Signal Level
1	+12V	PWR	+12V
2	GND	GND	



## 2.4.6 Audio I/O Port (CN9)

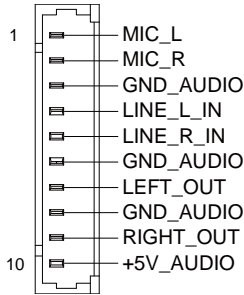

Pin	Pin name	Signal Type	Signal Level
1	MIC_L	IN	
2	MIC_R	IN	
3	GND_AUDIO	GND	
4	LINE_L_IN	IN	
5	LINE_R_IN	IN	
6	GND_AUDIO	GND	
7	LEFT_OUT	OUT	
8	GND_AUDIO	GND	
9	RIGHT_OUT	OUT	
10	+5V_AUDIO	PWR	+5V

## 2.4.7 MiniCard Slot (Half-MiniCard) (CN10)

Pin	Pin name	Signal Type	Signal Level
1	PCIE_WAKE#	IN	
2	+3.3VSB	PWR	+3.3V
3	NC		
4	GND	GND	

5	NC		
6	+1.5V	PWR	+1.5V
7	PCIE_CLK_REQ#	IN	
8	NC		
9	GND	GND	
10	NC		
11	PCIE_REF_CLK-	DIFF	
12	NC		
13	PCIE_REF_CLK+	DIFF	
14	NC		
15	GND	GND	
16	NC		
17	NC		
18	GND	GND	
19	NC		
20	W_DISABLE#	OUT	+3.3V
21	GND	GND	
22	PCIE_RST#	OUT	+3.3V
23	PCIE_RX-	DIFF	
24	+3.3VSB	PWR	+3.3V
25	PCIE_RX+	DIFF	
26	GND	GND	
27	GND	GND	
28	+1.5V	PWR	+1.5V
29	GND	GND	
30	SMB_CLK	I/O	+3.3V
31	PCIE_TX-	DIFF	
32	SMB_DATA	I/O	+3.3V

33	PCIE_TX+	DIFF	
34	GND	GND	
35	GND	GND	
36	USB_D-	DIFF	
37	GND	GND	
38	USB_D+	DIFF	
39	+3.3VSB	PWR	+3.3V
40	GND	GND	
41	+3.3VSB	PWR	+3.3V
42	NC		
43	GND	GND	
44	NC		
45	NC		
46	NC		
47	NC		
48	+1.5V	PWR	+1.5V
49	NC		
50	GND	GND	
51	NC		
52	+3.3VSB	PWR	+3.3V

**Note 1:** CN10 can be selected for Mini-Card or mSATA by changing BOM.

**Note 2:** You can choose the function either from mSATA or from CFast on the motherboard.

## 2.4.8 LPC Port (CN11)

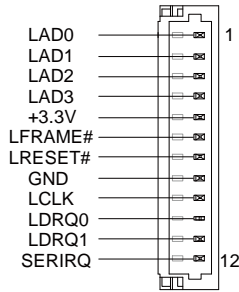

Pin	Pin name	Signal Type	Signal Level
1	LAD0	I/O	+3.3V
2	LAD1	I/O	+3.3V
3	LAD2	I/O	+3.3V
4	LAD3	I/O	+3.3V
5	+3.3V	PWR	+3.3V
6	LFRAME#	IN	
7	LRESET#	OUT	+3.3V
8	GND	GND	
9	LCLK	OUT	
10	LDRQ0	IN	
11	LDRQ1	IN	
12	SERIRQ	I/O	+3.3V

## 2.4.9 COM Port 2 Connector (CN12 of mainboard)

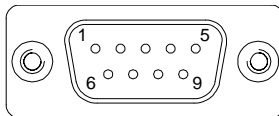

## RS-232

Pin	Pin Name
2	RS232 RxD
3	RS232 TxD
5	GND
7	RS232 RTS
8	RS232 CTS

## RS-422

Pin	Pin name
1	RS422_TX+
4	RS422_RX+
5	GND
6	RS422 TX-
9	RS422 RX-

## RS-485

Pin	Pin name
1	RS485 TX+/RX+
6	RS485 TX-/RX-

**Note:** COM2 can be configured into RS-232/422/485 through BIOS settings. Default is RS-232

## 2.4.10 LPT Port (CN13)

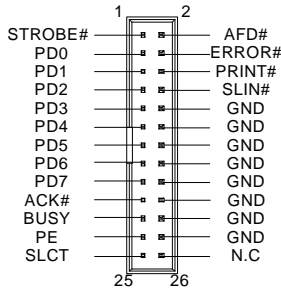

Pin	Pin name	Signal Type	Signal Level
1	STROBE#	IN	
2	AFD#	I/O	
3	PD0	I/O	
4	ERROR#	IN	
5	PD1	I/O	
6	PRINT#	I/O	
7	PD2	I/O	
8	SLIN#	I/O	
9	PD3	I/O	
10	GND	GND	
11	PD4	I/O	
12	GND	GND	
13	PD5	I/O	
14	GND	GND	
15	PD6	I/O	
16	GND	GND	
17	PD7	I/O	
18	GND	GND	
19	ACK#	IN	

20	GND	GND
21	BUSY	IN
22	GND	GND
23	PE	IN
24	GND	GND
25	SLCT	IN
26	NC	

### 2.4.11 COM Port 3 Connector (CN14 of mainboard)

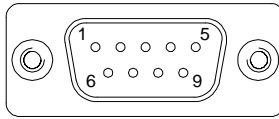

#### RS-232

Pin	Pin Name
2	RS232 RxD
3	RS232 TxD
5	GND
7	RS232 RTS
8	RS232 CTS

#### RS-422

Pin	Pin name
1	RS422_TX+
4	RS422_RX+
5	GND
6	RS422 TX-
9	RS422 RX-

## RS-485

Pin	Pin name
1	RS485 TX+/RX+
6	RS485 TX-/RX-

**Note:** COM3 can be configured into RS-232/422/485 through BIOS settings. Default is RS-232

### 2.4.12 COM Port 4 (CN15 of mainboard)

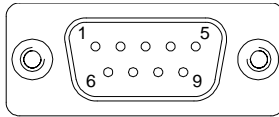

## RS-232

Pin	Pin Name
1	
2	RS232 RxD
3	RS232 TxD
4	
5	GND
6	
7	RS232 RTS
8	RS232 CTS
9	

### 2.4.13 Digital IO Port (CN16)

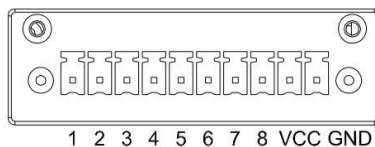



Pin	Pin name	Signal Type	Signal Level
1	DIO0	I/O	+5V
2	DIO1	I/O	+5V
3	DIO2	I/O	+5V
4	DIO3	I/O	+5V
5	DIO4	I/O	+5V
6	DIO5	I/O	+5V
7	DIO6	I/O	+5V
8	DIO7	I/O	+5V
9	+5V	PWR	+5V
10	GND	GND	

#### 2.4.14 USB 2.0 Port 3 (CN17)

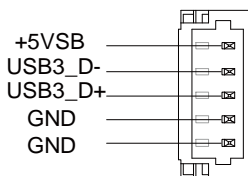

Pin	Pin name	Signal Type	Signal Level
1	+5VSB	PWR	
2	USB3_D-	DIFF	
3	USB3_D+	DIFF	
4	GND	GND	
5	GND	GND	

### 2.4.15 USB 2.0 Port 2 (CN18)

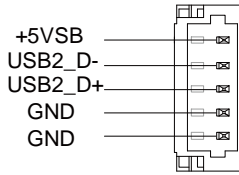

Pin	Pin name	Signal Type	Signal Level
1	+5VSB	PWR	+5V
2	USB2_D-	DIFF	
3	USB2_D+	DIFF	
4	GND	GND	
5	GND	GND	

### 2.4.16 USB Port 2 and 3 (CN17/18)

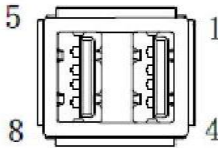

Pin	Pin name	Signal Type	Signal Level
1	+5VSB	PWR	+5V
2	USB0_D-	DIFF	
3	USB0_D+	DIFF	
4	GND	GND	
5	+5VSB	PWR	+5V
6	USB0_D-	DIFF	
7	USB0_D+	DIFF	
8	GND	GND	

### 2.4.17 BIOS Debug Port (CN19)

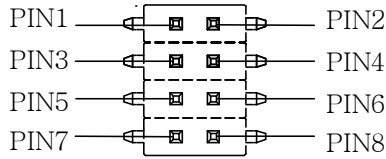

Pin	Pin name	Signal Type	Signal Level
1	+3.3VSB	PWR	+3.3V
2	GND	GND	
3	SPI_CS	IN	
4	SPI_CLK	IN	
5	SPI_MISO	OUT	
6	SPI_MOSI	IN	
7	NC		
8	NC		

### 2.4.18 PS/2 Keyboard/Mouse Combo Port (CN22)

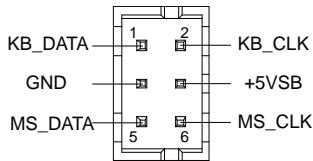

Pin	Pin name	Signal Type	Signal Level
1	KB_DATA	I/O	+5V
2	KB_CLK	I/O	+5V
3	GND	GND	
4	+5VSB	PWR	+5V
5	MS_DATA	I/O	+5V
6	MS_CLK	I/O	+5V

## 2.4.19 USB Ports 0 and 1 (CN25)

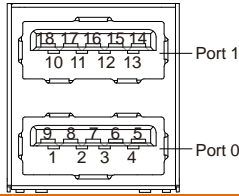

Pin	Pin name	Signal Type	Signal Level
1	+5VSB	PWR	+5V
2	USB0_D-	DIFF	
3	USB0_D+	DIFF	
4	GND	GND	
5	USB0_SSRX-	DIFF	
6	USB0_SSRX+	DIFF	
7	GND	GND	
8	USB0_SSTX-	DIFF	
9	USB0_SSTX+	DIFF	
10	+5VSB	PWR	+5V
11	USB1_D-	DIFF	
12	USB1_D+	DIFF	
13	GND	GND	
14	NC		
15	NC		
16	GND	GND	
17	NC		
18	NC		

Note: Only Port0 supports USB 3.0

## 2.4.20 LAN (RJ-45) Port1 (CN26)

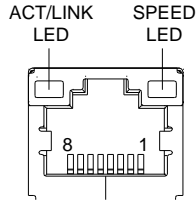

Pin	Pin name	Signal Type	Signal Level
1	MDI0+	DIFF	
2	MDI0-	DIFF	
3	MDI1+	DIFF	
4	MDI2+	DIFF	
5	MDI2-	DIFF	
6	MDI1-	DIFF	
7	MDI3+	DIFF	
8	MDI3-	DIFF	

## 2.4.21 LAN (RJ-45) Port2 (CN27)

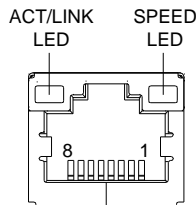

Pin	Pin name	Signal Type	Signal Level
1	MDI0+	DIFF	
2	MDI0-	DIFF	
3	MDI1+	DIFF	
4	MDI2+	DIFF	

5	MDI2-	DIFF
6	MDI1-	DIFF
7	MDI3+	DIFF
8	MDI3-	DIFF

### 2.4.22 COM Port 1 (D-SUB 9) (CN28)

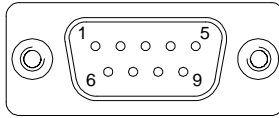

#### RS-232

Pin	Pin Name
1	
2	RS232 RxD
3	RS232 TxD
4	
5	GND
6	
7	RS232 RTS
8	RS232 CTS
9	

### 2.4.23 HDMI Port (CN29)

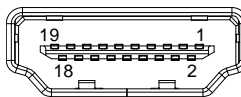

Pin	Pin name	Signal Type	Signal Level
1	TMDS_DAT2+	DIFF	

2	GND	GND	
3	TMDS_DAT2-	DIFF	
4	TMDS_DAT1+	DIFF	
5	GND	GND	
6	TMDS_DAT1-	DIFF	
7	TMDS_DAT0+	DIFF	
8	GND	GND	
9	TMDS_DAT0-	DIFF	
10	TMDS_CLK+	DIFF	
11	GND	GND	
12	TMDS_CLK-	DIFF	
13	NC		
14	NC		
15	DDC_CLK	I/O	+5V
16	DDC_DATA	I/O	+5V
17	GND	GND	
18	+5V	I/O	+5V
19	HPLG_DETECT	IN	

#### 2.4.24 VGA Port (CN30)

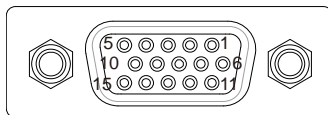

Pin	Pin name	Signal Type	Signal Level
1	RED	OUT	
2	GREEN	OUT	
3	BLUE	OUT	
4	NC		

5	GND	GND	
6	RED_GND_RTN	GND	
7	GREEN_GND_RTN	GND	
8	BLUE_GND_RTN	GND	
9	+5V	PWR	+5V
10	CRT_PLUG#		
11	NC		
12	DDC_DATA	I/O	+5V
13	HSYNC	OUT	
14	VSYNC	OUT	
15	DDC_CLK	I/O	+5V

#### 2.4.25 Battery (CN31)

Pin	Pin name	Signal Type	Signal Level
1	+3.3V	PWR	3.3V
2	GND	GND	

#### 2.4.26 CFast Slot (CN33)

Pin	Pin name	Signal Type	Signal Level
S1	GND	GND	
S2	SATA_TX+	DIFF	
S3	SATA_TX-	DIFF	
S4	GND	GND	
S5	SATA_RX-	DIFF	
S6	SATA_RX+	DIFF	



S7	GND	GND	
PC1	NC		
PC2	GND	GND	
PC3	NC		
PC4	NC		
PC5	NC		
PC6	NC		
PC7	GND	GND	
PC8	NC		
PC9	NC		
PC10	NC		
PC11	NC		
PC12	NC		
PC13	+3.3V	PWR	+3.3V
PC14	+3.3V	PWR	+3.3V
PC15	GND	GND	
PC16	GND	GND	
PC17	NC		

### 2.4.27 DDR3L SO-DIMM Slot (CN34)

Standard Specification

### 2.4.28 UIM Card Socket (CN35)

Pin	Pin name	Signal Type	Signal Level
1	UIM_PWR	PWR	
2	UIM_RST	IN	
3	UIM_CLK	IN	

4	GND	GND
5	UIM_VPP	PWR
6	UIM_DATA	I/O

#### 2.4.29 MiniCard Slot (Full-MiniCard) (CN37)

Pin	Pin name	Signal Type	Signal Level
1	PCIE_WAKE#	IN	
2	+3.3VSB	PWR	+3.3V
3	NC		
4	GND	GND	
5	NC		
6	+1.5V	PWR	+1.5V
7	PCIE_CLK_REQ#	IN	
8	UIM_PWR	PWR	
9	GND	GND	
10	UIM_DATA	I/O	
11	PCIE_REF_CLK-	DIFF	
12	UIM_CLK	IN	
13	PCIE_REF_CLK+	DIFF	
14	UIM_RST	IN	
15	GND	GND	
16	UIM_VPP	PWR	
17	NC		
18	GND	GND	
19	NC		
20	W_DISABLE#	OUT	+3.3V
21	GND	GND	

22	PCIE_RST#	OUT	+3.3V
23	PCIE_RX-	DIFF	
24	+3.3VSB	PWR	+3.3V
25	PCIE_RX+	DIFF	
26	GND	GND	
27	GND	GND	
28	+1.5V	PWR	+1.5V
29	GND	GND	
30	SMB_CLK	I/O	+3.3V
31	PCIE_TX-	DIFF	
32	SMB_DATA	I/O	+3.3V
33	PCIE_TX+	DIFF	
34	GND	GND	
35	GND	GND	
36	USB_D-	DIFF	
37	GND	GND	
38	USB_D+	DIFF	
39	+3.3VSB	PWR	+3.3V
40	GND	GND	
41	+3.3VSB	PWR	+3.3V
42	NC		
43	GND	GND	
44	NC		
45	NC		
46	NC		
47	NC		
48	+1.5V	PWR	+1.5V
49	NC		

50	GND	GND	
51	NC		
52	+3.3VSB	PWR	+3.3V

## 2.5 Hard Disk Drive Installation (A2/A2M)

Step 1: Remove the baseplate as instructed below

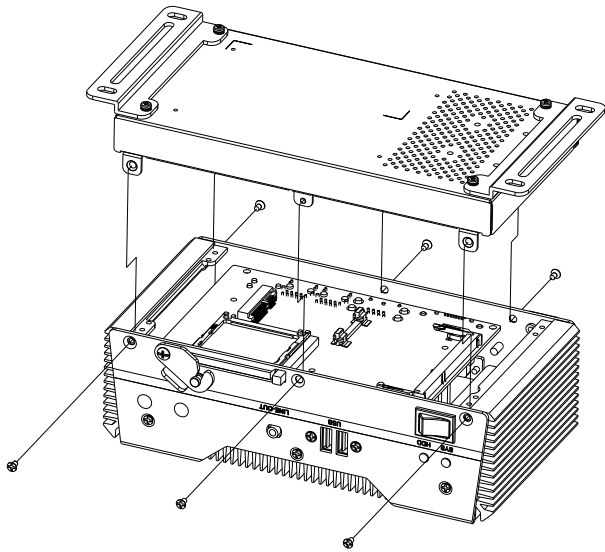

Step 2: Place the HDD on the bracket plate



Step 3: Tighten the screws at the back to secure the HDD

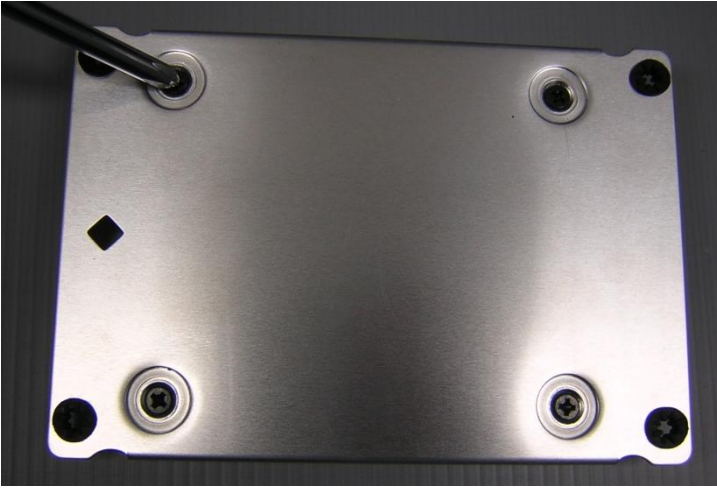

Step 4: Connect the SATA and power cables to the HDD, attach the HDD assembly to the baseplate.



## 2.6 RAM Installation (A1/A1M)

Step 1: Remove the screws on the baseplate



Step 2: Remove the screw on the front panel as shown below



Step 3: Remove the screw on the rear panel as shown below

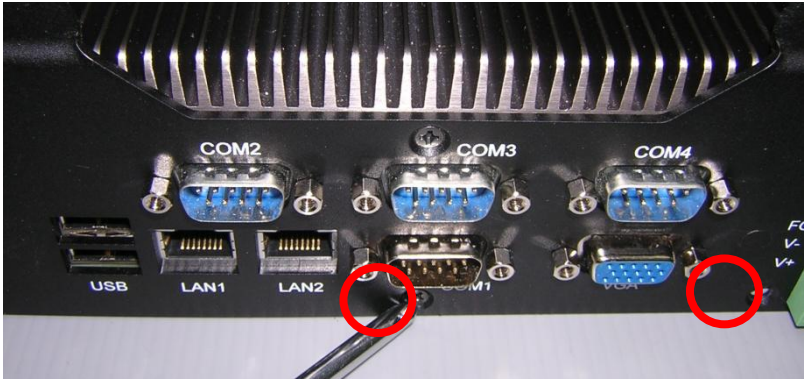

Step 4: Remove the baseplate, insert the RAM into the RAM slot

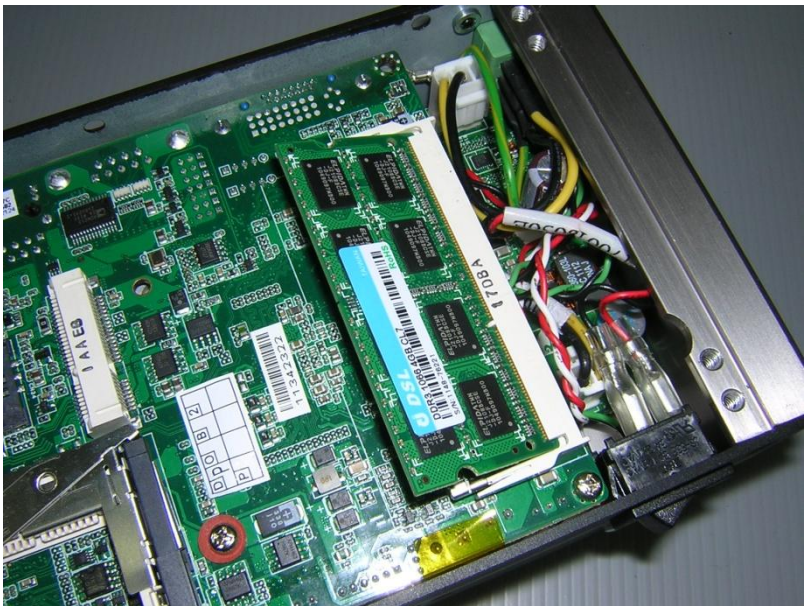



Step 5: Push down to secure the RAM



Step 6: Place a thermal pad over the RAM

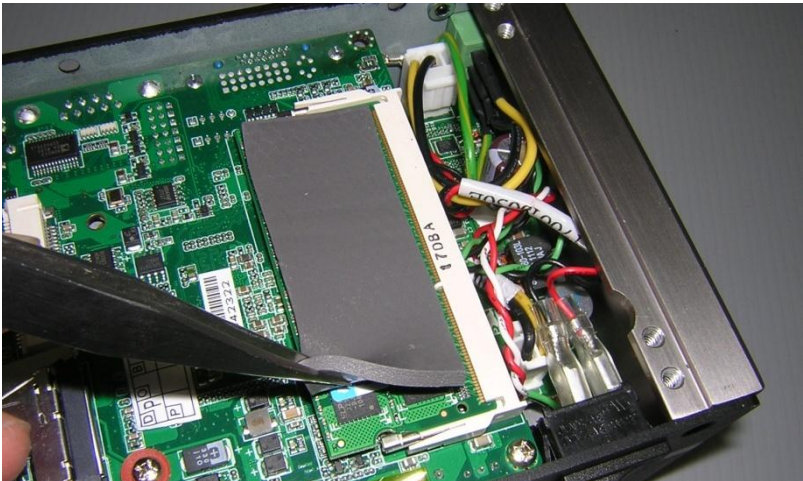

Step 7: Close and secure the baseplate

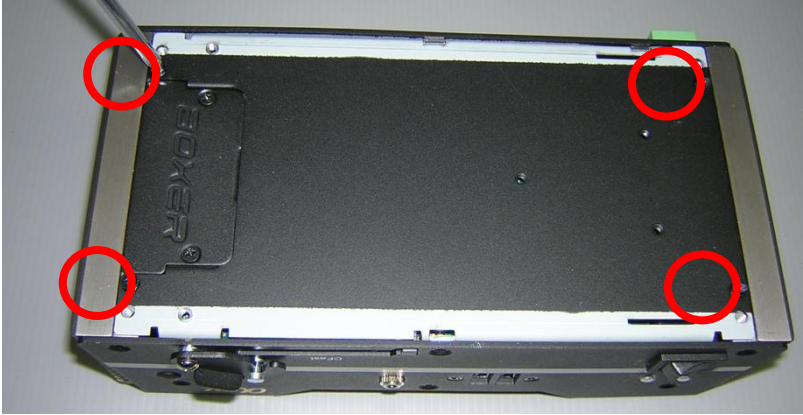

Step 8: Close and secure the front panel as shown below



Step 9: Close and secure the rear panel as shown below

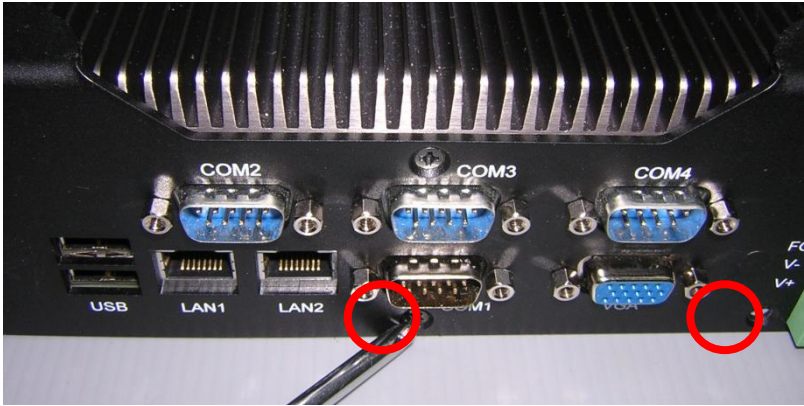

## 2.7 RAM Installation (A2/A2M)

Step 1: Remove the baseplate as instructed below

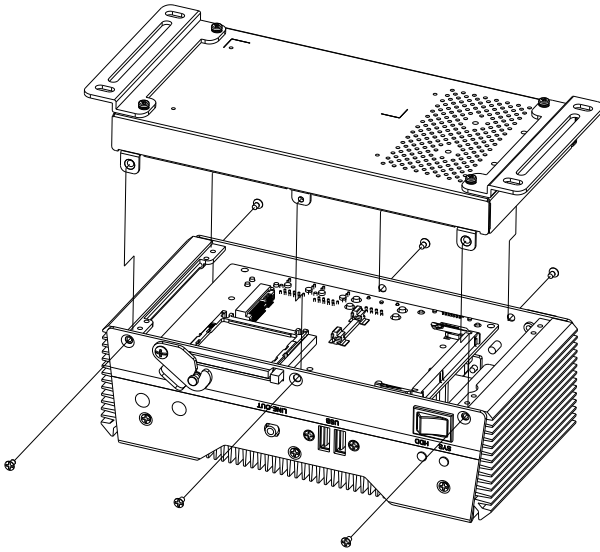

Step 2: Insert the RAM into the RAM slot

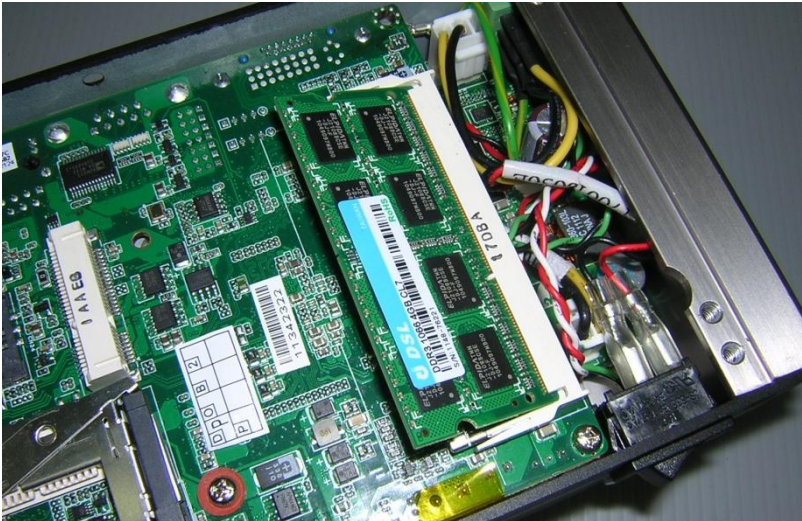



Step 3: Push down to secure the RAM

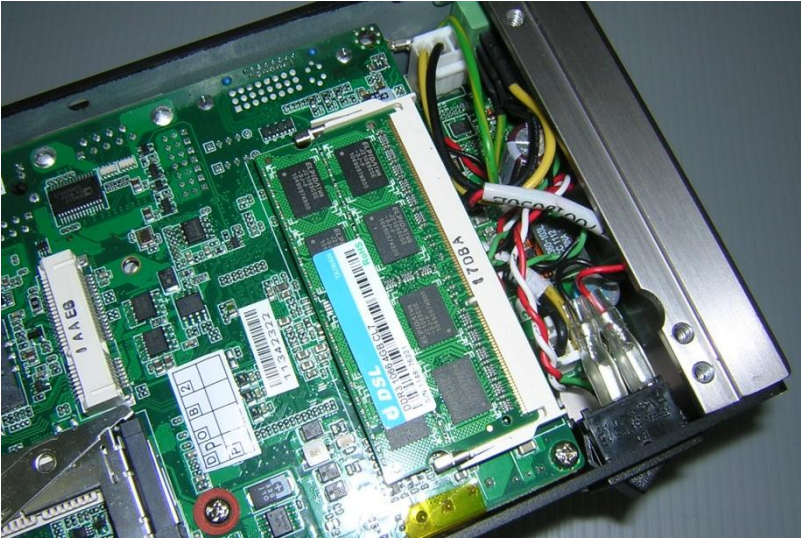

Step 4: Close the baseplate as instructed below

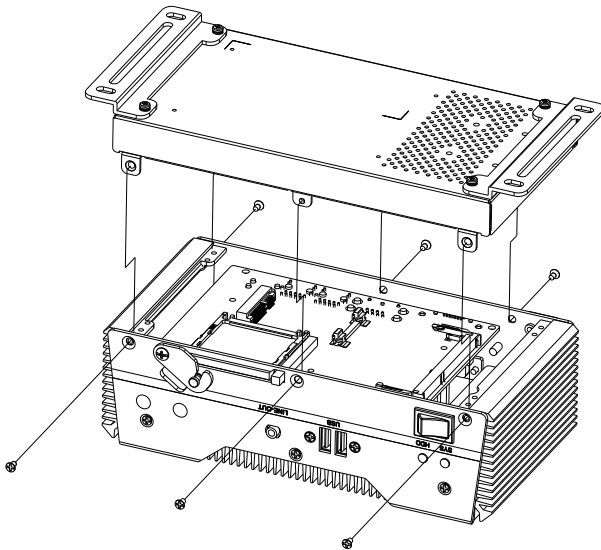

## 2.8 CFast™ Installation (A1/A1M/A2/A2M)

Step 1: Insert a CFast™ Card into the CFast™ slot



Step 2: Lower the arm to secure the CFast™ Card



## 2.9 Wallmount Installation

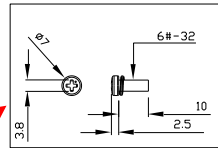
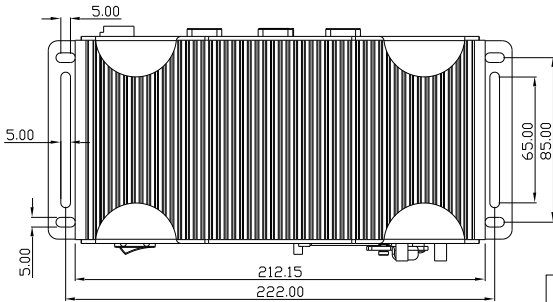
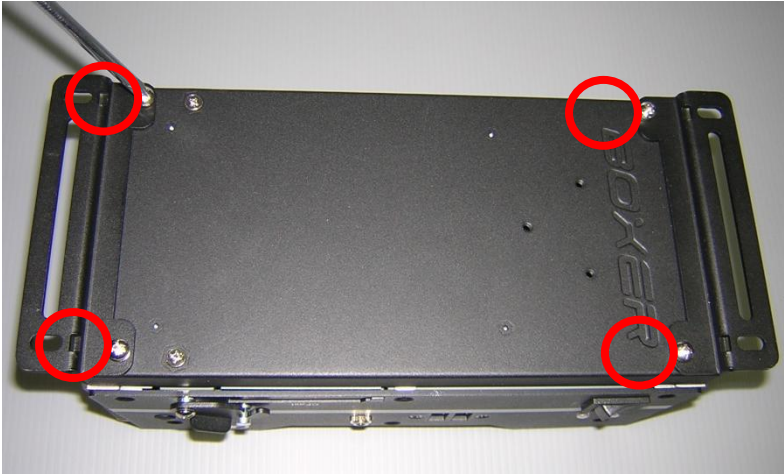

We suggest using this screw.

# Chapter 3

---

AMI BIOS Setup



### 3.1 System Test and Initialization

---

The system uses certain routines to perform testing and initialization. If an error, fatal or non-fatal, is encountered, a few short beeps or an error message will be outputted. The board can usually continue the boot up sequence with non-fatal errors.

The system configuration verification routines check the current system configuration against the values stored in the CMOS memory. If they do not match, an error message will be outputted, in which case you will need to run the BIOS setup program to set the configuration information in memory.

There are three situations in which you will need to change the CMOS settings:

- You are starting your system for the first time
- You have changed your system's hardware
- The CMOS memory has lost power and the configuration information is erased

The system's CMOS memory uses a backup battery for data retention, which is to be replaced once emptied.

## 3.2 AMI BIOS Setup

---

The AMI BIOS ROM has a pre-installed Setup program that allows users to modify basic system configurations, which is stored in the battery-backed CMOS RAM and BIOS NVRAM so that the information is retained when the power is turned off.

To enter BIOS Setup, press <Del> or <F2> immediately while your computer is powering up.

The function for each interface can be found below.

**Main** – Date and time can be set here. Press <Tab> to switch between date elements

**Advanced** – Enable/ Disable boot option for legacy network devices

**Chipset** – For hosting bridge parameters

**Boot** – Enable/ Disable quiet Boot Option

**Security** – The setup administrator password can be set here

**Save & Exit** – Save your changes and exit the program

### 3.3 Setup Submenu: Main

Press "Delete" to enter Setup

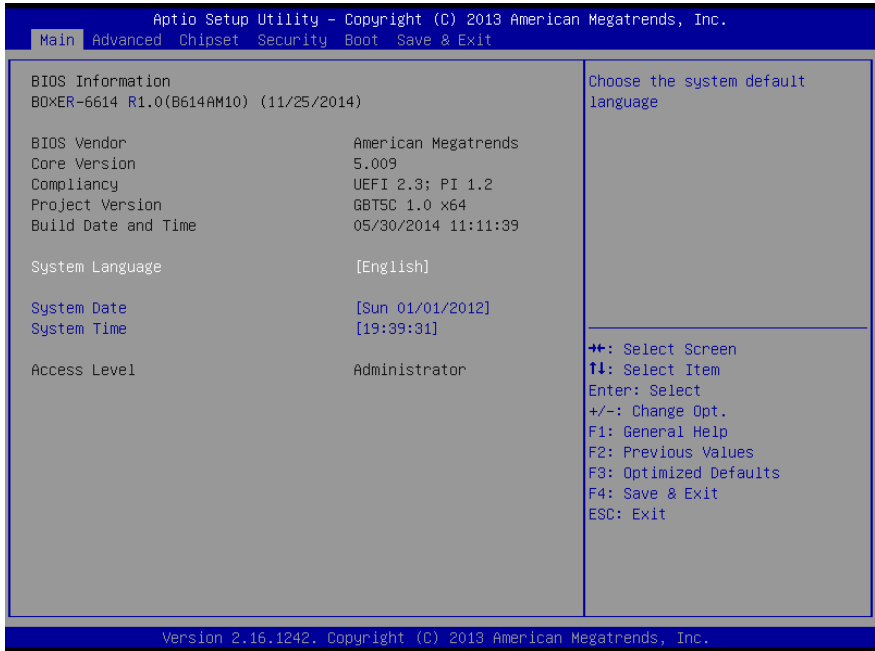

### 3.4 Setup Submenu: Advanced

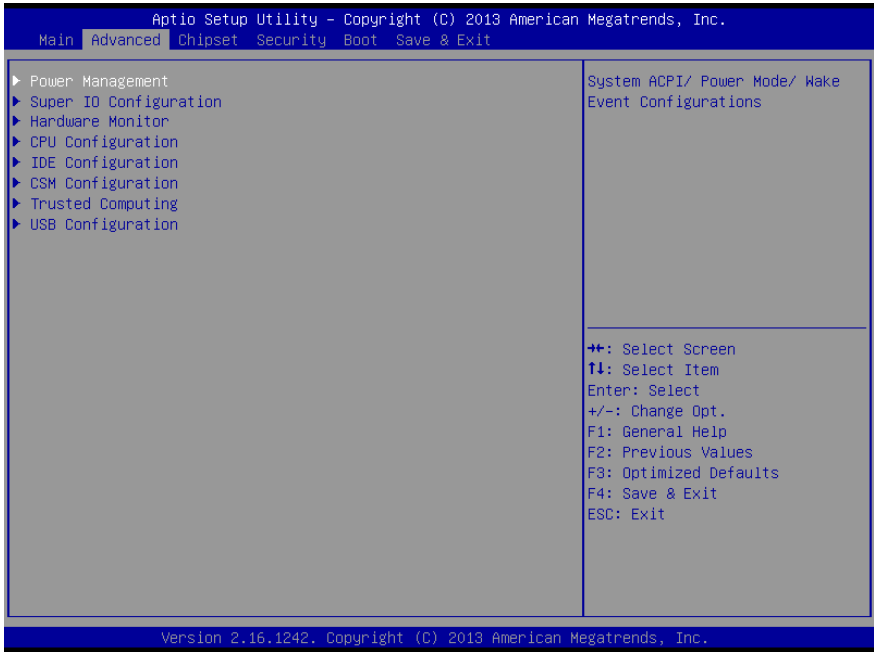

### 3.4.1 Advanced: Power Management

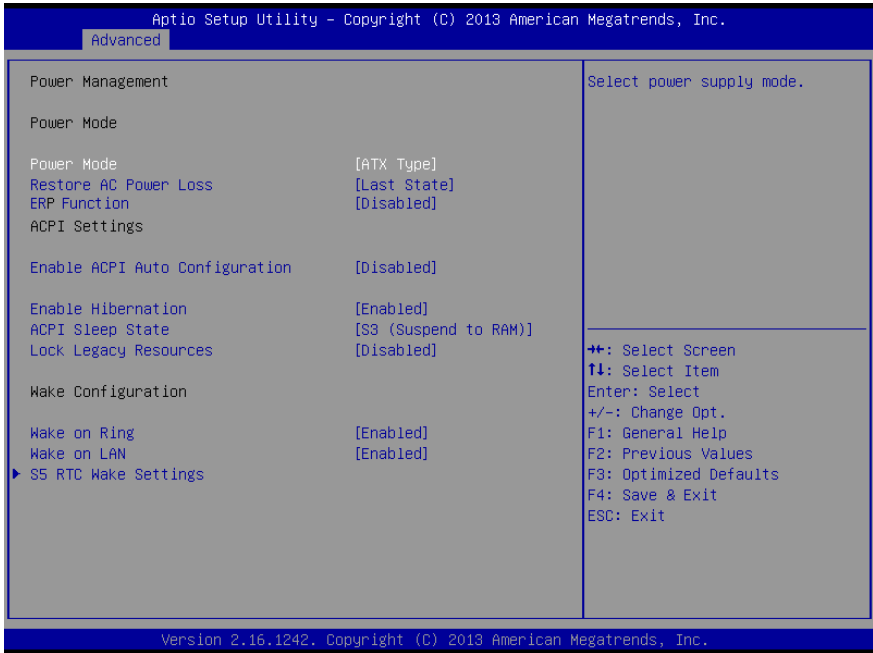

Options summary:

Power Mode	ATX Type	Optimal Default, Failsafe Default
	AT Type	
Select power supply mode		
Restore AC Power Loss	Last State	Optimal Default, Failsafe Default
	Power On	
	Power Off	
Select AC power state when power is re-applied after a power failure		
Enable ACPI Auto Configuration	Enable	
	Disable	Optimal Default, Failsafe Default
Enables or Disables BIOS ACPI Auto Configuration		

Enable Hibernation	Enable	Optimal Default, Failsafe Default
	Disable	
Enables or Disables System ability to Hibernate (OS/S4 Sleep State). This option may be not effective with some OS		
Lock Legacy Resources	Enable	
	Disable	Optimal Default, Failsafe Default
Enables or Disables Lock of Legacy Resources		
Wake on Ring	Enable	Optimal Default, Failsafe Default
	Disable	
Enabled/Disabled wake from Ring		
Wake on LAN	Enable	Optimal Default, Failsafe Default
	Disable	
Enabled/Disabled wake from LAN		

### 3.4.1.1 Power Management: S5 RTC Wake Settings

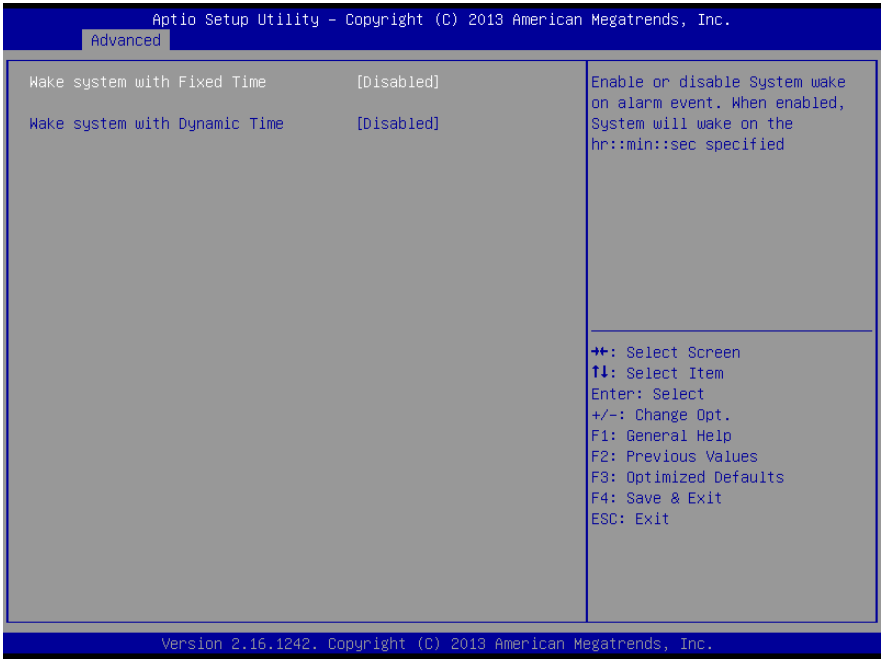

Options summary:

Wake system with Fixed Time		Enable	
		Disable	Optimal Default, Failsafe Default
	Wake up hour	0	
	Wake up minute	0	
	Wake up second	0	
Wake system with Dynamic Time		Enable	
		Disable	Optimal Default, Failsafe Default
	Wake up minute increase	0	
Select RTC wake mode			

### 3.4.2 Advanced: Super IO Configuration

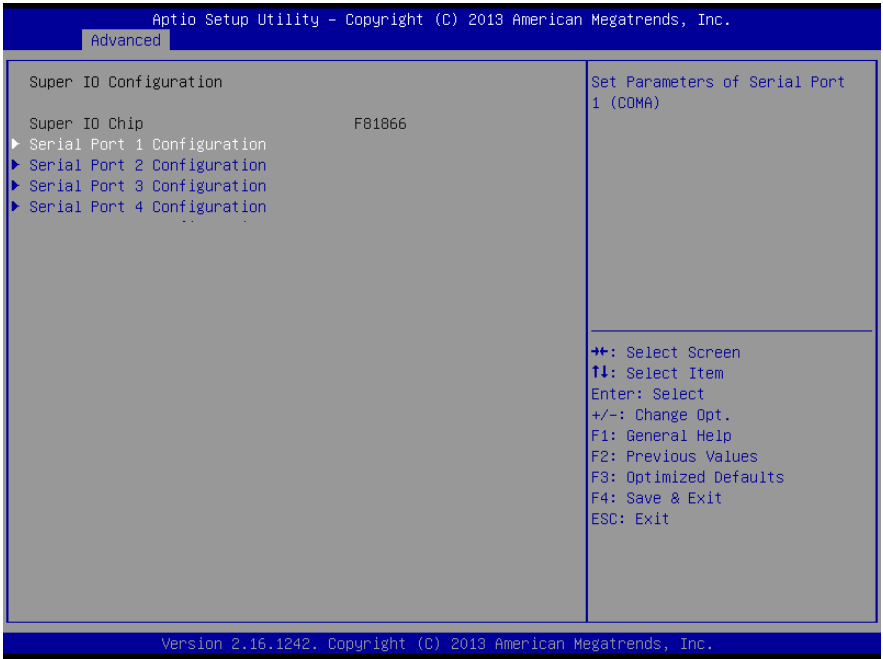

Options summary:

Serial Port	Disabled	
	Enabled	Optimal Default, Failsafe Default
Enable or Disable Serial Port (COM)		
Change Settings	Auto	Optimal Default, Failsafe Default
	IO=2E8h; IRQ=3;	
	IO=3F8h; IRQ=3,4;	
	IO=2F8h; IRQ=3,4;	
	IO=3E8h; IRQ=3,4;	
IO=2E8h; IRQ=3,4;		
Select an optimal setting for Super IO device		



### 3.4.2.1 Super IO Configuration: Serial Port 1 Configuration

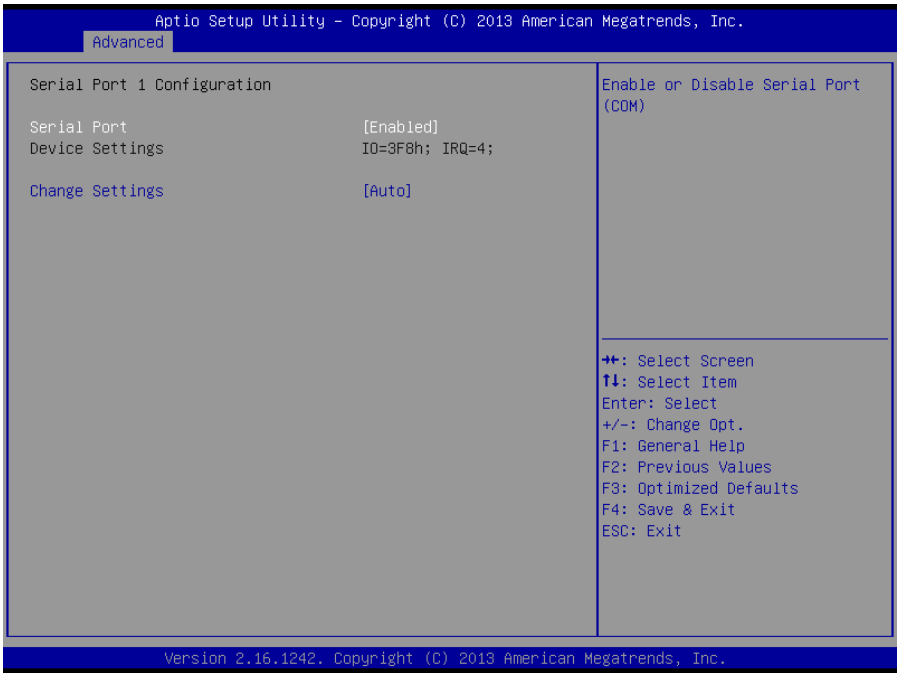

### 3.4.2.2 Super IO Configuration: Serial Port 2 Configuration

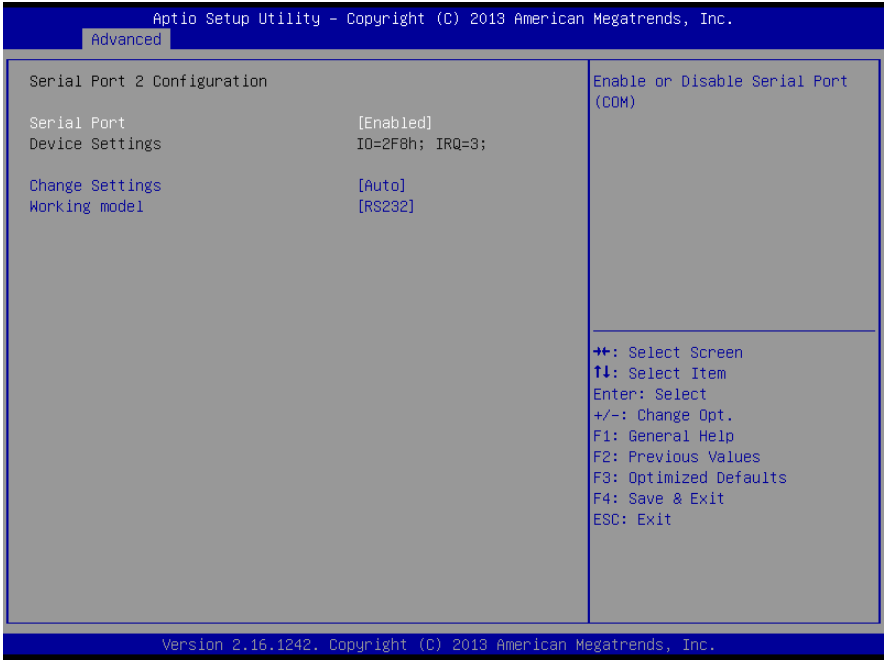

### 3.4.2.3 Super IO Configuration: Serial Port 3 Configuration

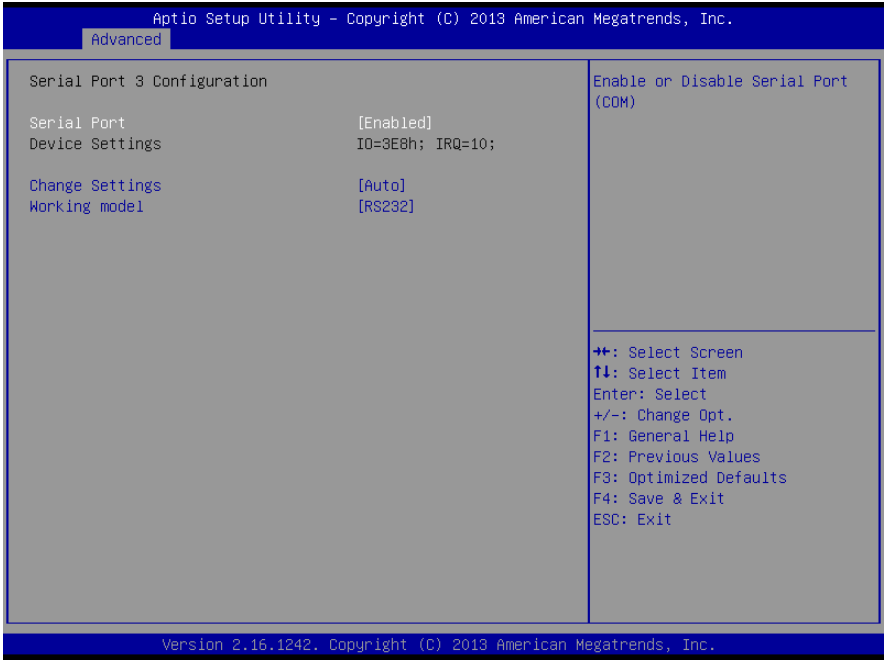

### 3.4.2.4 Super IO Configuration: Serial Port 4 Configuration

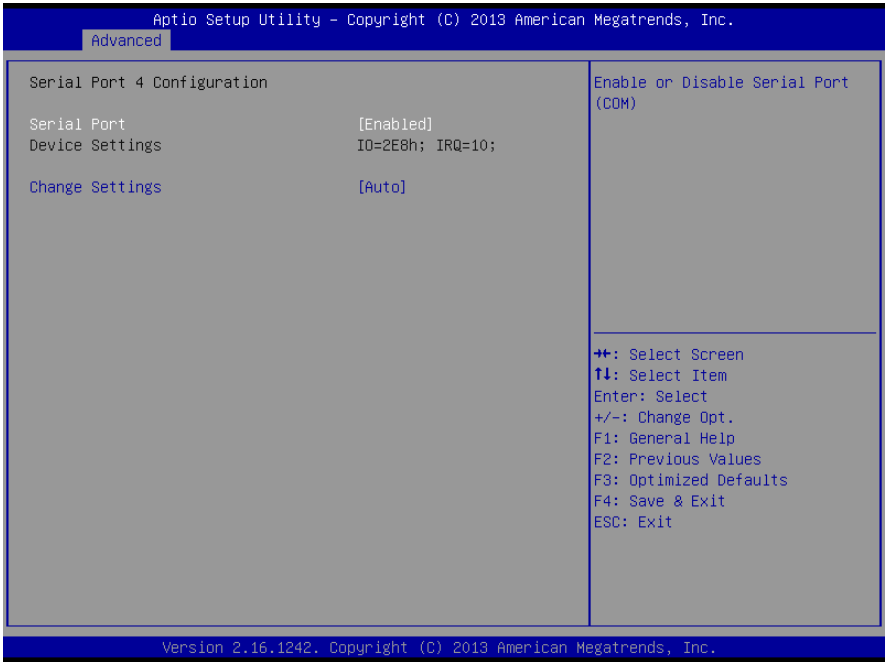

Options summary:

Serial Port	Disabled	
	Enabled	Default
Allows BIOS to En/Disable correspond serial port.		
Change Settings (Serial Port 1)	Auto	Default
	IO=3F8h; IRQ=4;	
	IO=3F8h; IRQ=3,4,5,6,7,9,10,11,12;	
	IO=2F8h; IRQ=3,4,5,6,7,9,10,11,12;	
	IO=2F8h; IRQ=3,4,5,6,7,9,10,11,12;	

	IO=3E8h; IRQ=3,4,5,6,7,9,10,11,12;			
	IO=2E8h; IRQ=3,4,5,6,7,9,10,11,12;			
Allows BIOS to Select Serial Port resource.				
Change Settings (Serial Port 2)	Auto	Default		
	IO=2F8h; IRQ=3;			
	IO=3F8h; IRQ=3,4,5,6,7,9,10,11,12;			
	IO=2F8h; IRQ=3,4,5,6,7,9,10,11,12;			
	IO=3E8h; IRQ=3,4,5,6,7,9,10,11,12;			
	IO=2E8h; IRQ=3,4,5,6,7,9,10,11,12;			
	Working model		RS232	Default
			RS422	
	RS485			
Select Working model				
Change Settings (Serial Port 3)	Auto	Default		
	IO=3E8h; IRQ=7;			
	IO=3E8h; IRQ=3,4,5,6,7,9,10,11,12;			
	IO=2E8h; IRQ=3,4,5,6,7,9,10,11,12;			
	IO=3E8h; IRQ=3,4,5,6,7,9,10,11,12;			

	IO=2E8h; IRQ=3,4,5,6,7,9,10,11,12;	
Working model	RS232	Default
	RS422	
	RS485	
Select Working model		
Change Settings (Serial Port 4)	Auto	Default
	IO=2E8h; IRQ=7;	
	IO=3F8h; IRQ=3,4,5,6,7,9,10,11,12;	
	IO=2F8h; IRQ=3,4,5,6,7,9,10,11,12;	
	IO=3E8h; IRQ=3,4,5,6,7,9,10,11,12;	
	IO=2E8h; IRQ=3,4,5,6,7,9,10,11,12;	
Allows BIOS to Select Serial Port resource.		
Smart Fan Function	Enable	
	Disable	Optimal Default, Failsafe Default
Enable or Disable Smart Fan		

### 3.4.3 Advanced: H/W Monitor

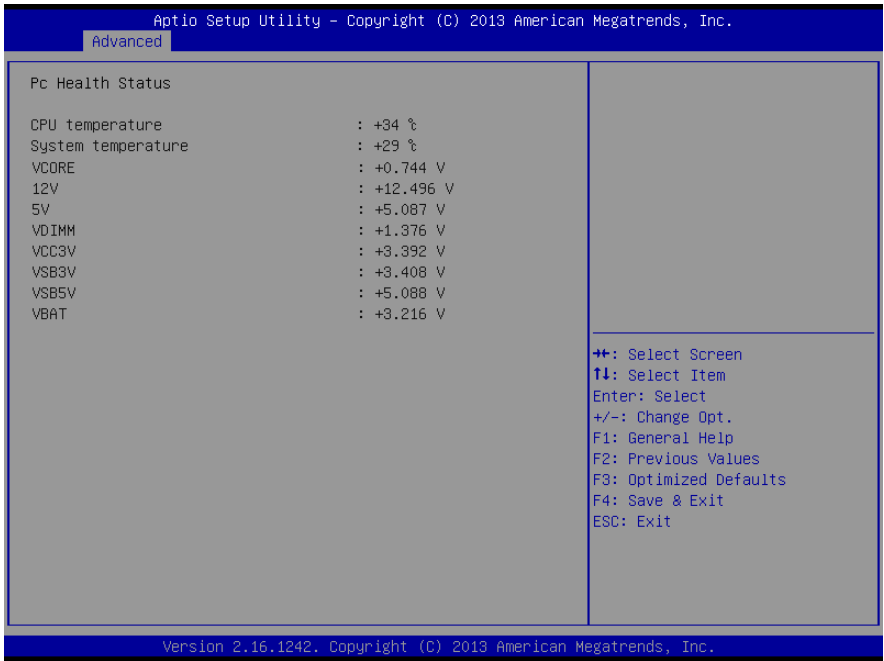

### 3.4.4 Advanced: CPU Configuration

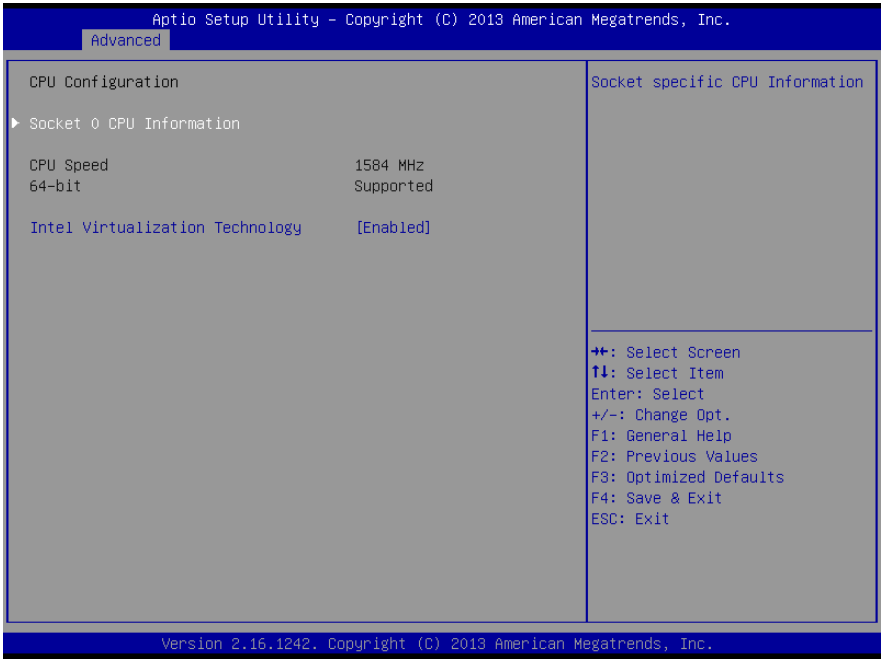

Options summary:

Intel Virtualization	Disabled	Optimal Default, Failsafe Default
Technology	Enabled	
When enabled, a VMM can utilize the additional hardware capabilities provided by Vander pool Technology		



### 3.4.4.1 CPU Configuration: Socket 0 CPU Configuration

The screenshot shows the Aptio Setup Utility interface. At the top, it reads "Aptio Setup Utility - Copyright (C) 2013 American Megatrends, Inc." Below this, a blue bar contains the word "Advanced" in white. The main area is divided into two columns. The left column, titled "Socket 0 CPU Information", lists the following details: Intel(R) Celeron(R) CPU N2807 @ 1.58GHz, CPU Signature 30678, Microcode Patch 815, Max CPU Speed 1580 MHz, Min CPU Speed 500 MHz, Processor Cores 2, Intel HT Technology Not Supported, Intel VT-x Technology Supported, L1 Data Cache 24 KB x 2, L1 Code Cache 32 KB x 2, L2 Cache 1024 KB x 1, and L3 Cache Not Present. The right column contains a legend for navigation: F10: Select Screen, F9: Select Item, Enter: Select, +/-: Change Opt., F1: General Help, F2: Previous Values, F3: Optimized Defaults, F4: Save & Exit, and ESC: Exit. At the bottom of the screen, a blue bar displays "Version 2.16.1242. Copyright (C) 2013 American Megatrends, Inc."

Socket 0 CPU Information	
Intel(R) Celeron(R) CPU N2807 @ 1.58GHz	
CPU Signature	30678
Microcode Patch	815
Max CPU Speed	1580 MHz
Min CPU Speed	500 MHz
Processor Cores	2
Intel HT Technology	Not Supported
Intel VT-x Technology	Supported
L1 Data Cache	24 KB x 2
L1 Code Cache	32 KB x 2
L2 Cache	1024 KB x 1
L3 Cache	Not Present

Navigation Legend:

- F10: Select Screen
- F9: Select Item
- Enter: Select
- +/-: Change Opt.
- F1: General Help
- F2: Previous Values
- F3: Optimized Defaults
- F4: Save & Exit
- ESC: Exit

### 3.4.5 Advanced: SATA Configuration

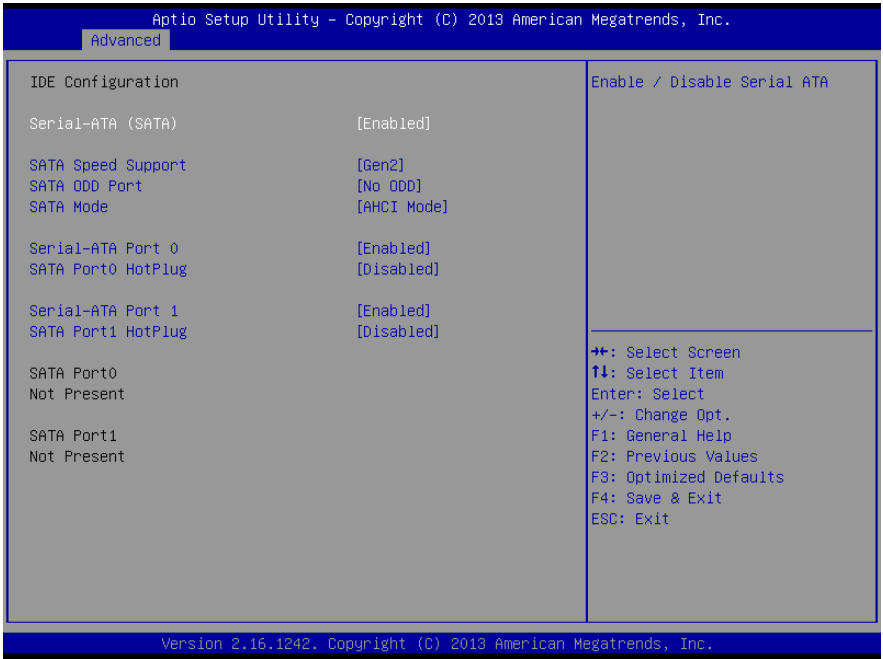

Options summary:

SATA Mode	IDE	Default
	AHCI	
IDE: Configure SATA controllers as legacy IDE		
AHCI: Configure SATA controllers to operate in AHCI mode		
En/Disable SATA Port		

### 3.4.6 Advanced: CSM Configuration

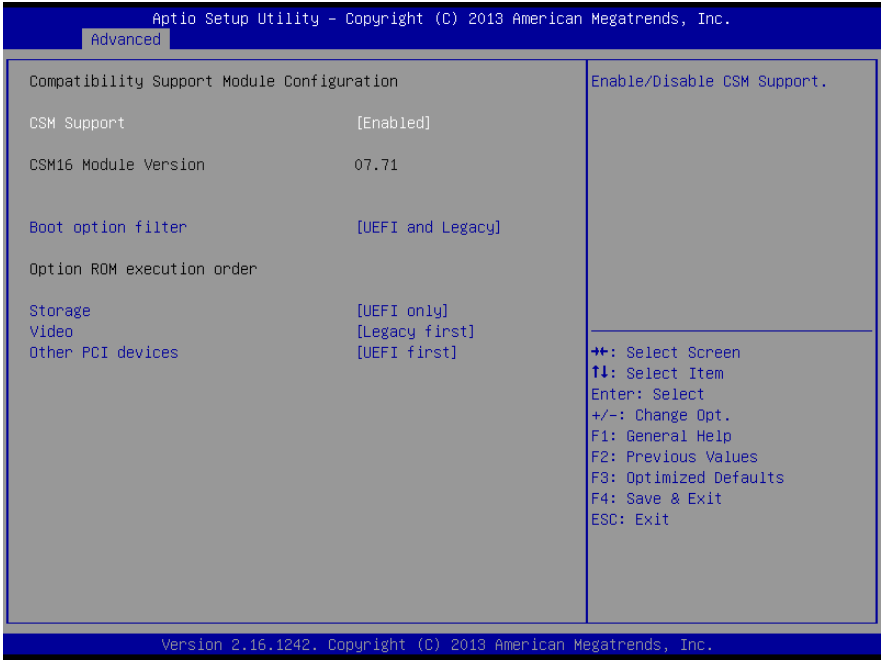

### 3.4.7 Advanced: Trusted Computing

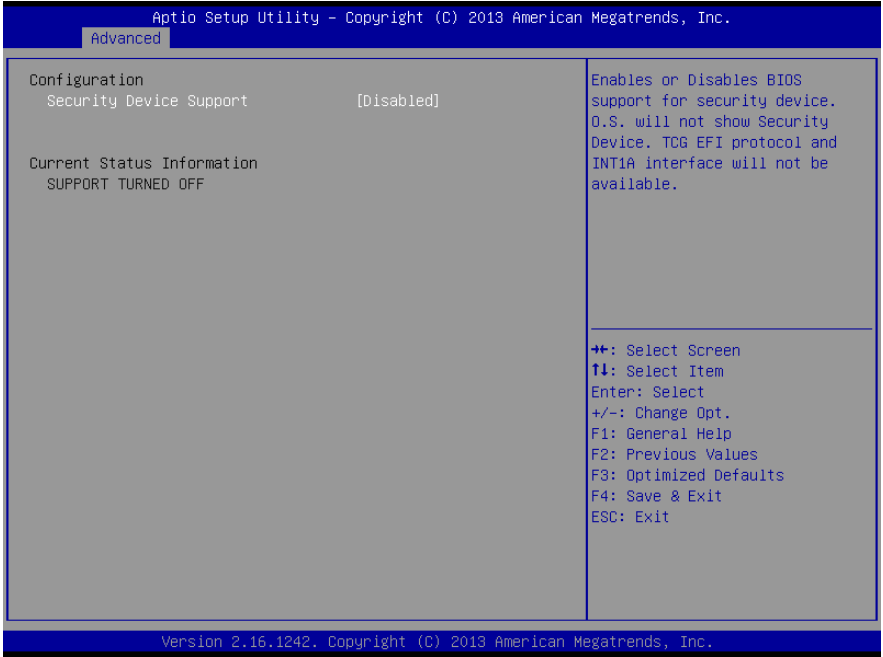

Options summary:

SATA controller(s)	Enabled	Optimal Default, Failsafe Default
	Disabled	
Enable or disable SATA Device.		
SATA Mode Selection	IDE	Optimal Default, Failsafe Default
	AHCI	
Determines how SATA controller(s) operate.		

### 3.4.8 Advanced: USB Configuration

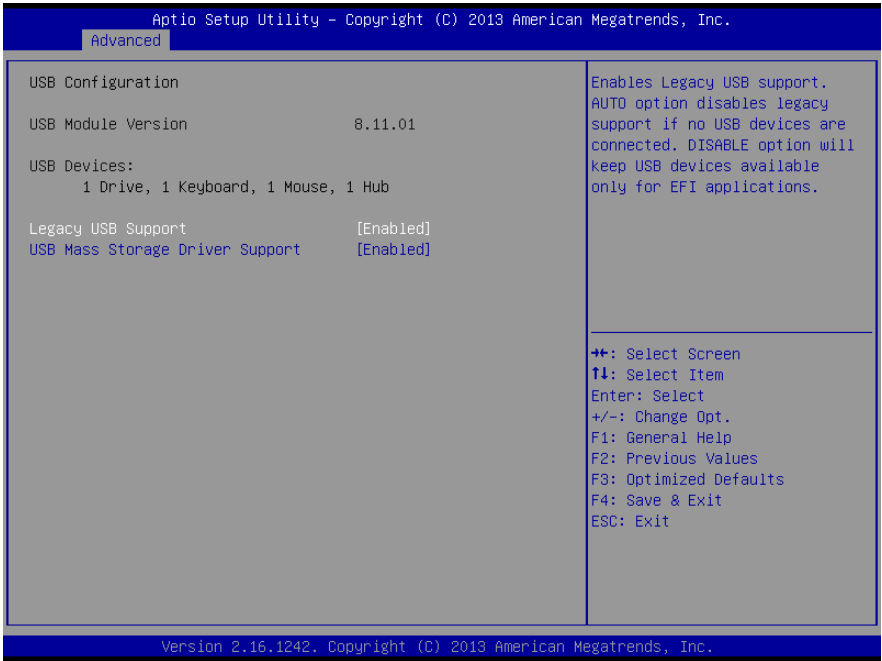

Options summary:

Legacy USB Support	Enabled	Optimal Default, Failsafe Default
	Disabled	
	Auto	
<p>Enables BIOS Support for Legacy USB Support. When enabled, USB can be functional in legacy environment like DOS.</p> <p>AUTO option disables legacy support if no USB devices are connected</p>		
Device Name (Emulation Type)	Auto	Optimal Default, Failsafe Default
	Floppy	
	Forced FDD	
	Hard Disk	

	CDROM
If Auto. USB devices less than 530MB will be emulated as Floppy and remaining as Floppy and remaining as hard drive. Forced FDD option can be used to force a HDD formatted drive to boot as FDD(Ex. ZIP drive)	

### 3.5 Setup submenu: Chipset

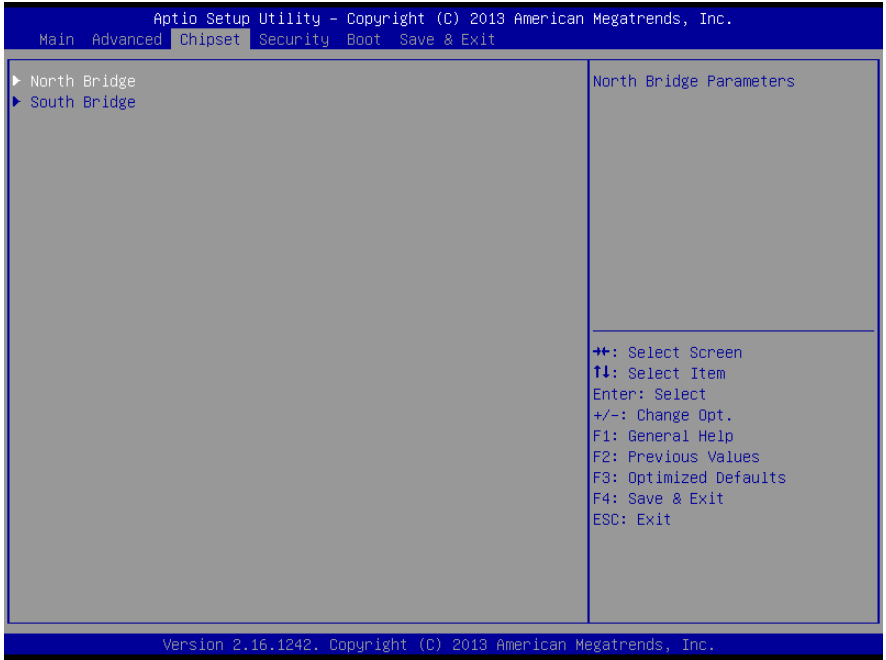

### 3.5.1 Chipset: Host Bridge

Aptio Setup Utility - Copyright (C) 2013 American Megatrends, Inc.

Chipset

Primary Boot Display	[VBIOS Default]	Select the Video Device which will be activated during POST. This has no effect if external graphics present. Secondary boot display selection will appear based on your selection. VGA modes will be supported only on primary display
Memory Information		
Total Memory	4096 MB (LPDDR3)	
Memory Slot0	4096 MB (LPDDR3)	

→+: Select Screen  
↑↓: Select Item  
Enter: Select  
+/-: Change Opt.  
F1: General Help  
F2: Previous Values  
F3: Optimized Defaults  
F4: Save & Exit  
ESC: Exit

Version 2.16.1242. Copyright (C) 2013 American Megatrends, Inc.



## 3.5.2 Chipset: South Bridge

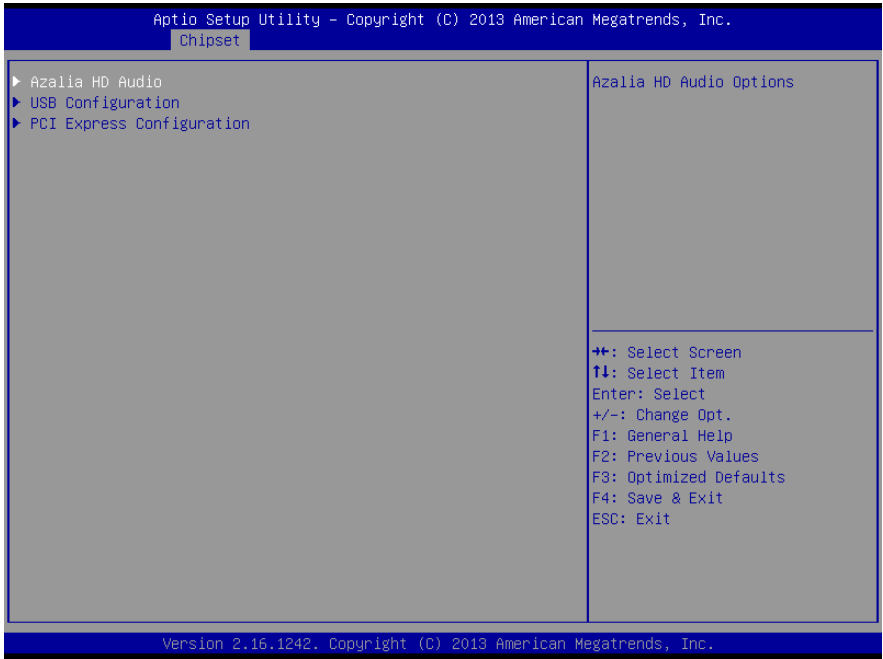

### 3.5.2.1 South Bridge: Azalia HD Audio

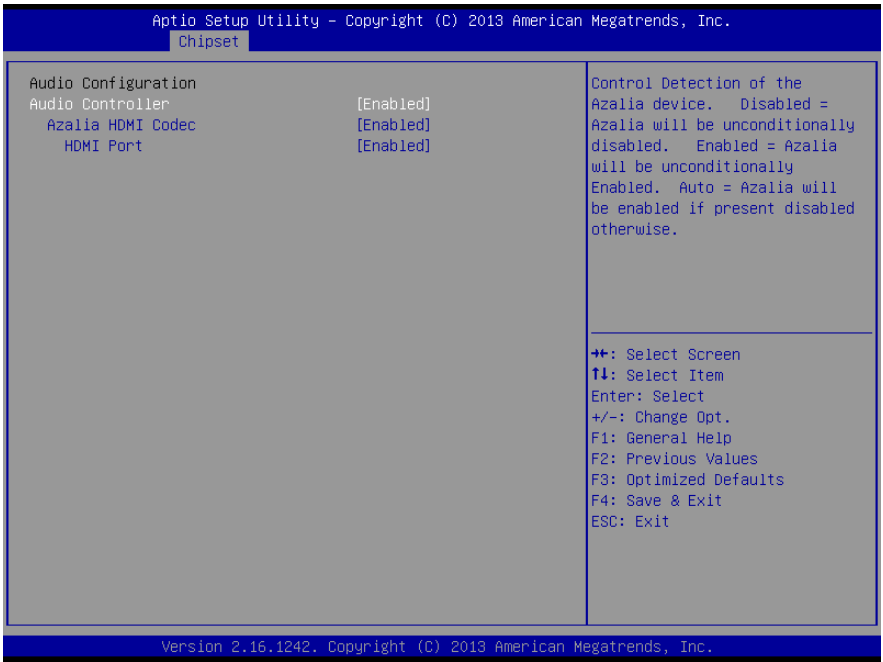

#### Options summary

Azalia HD Audio	Disabled	Optimal Default, Failsafe Default
	HD Audio	
Enabling/Disabling HD Audio controller.		

### 3.5.2.2 South Bridge: USB Configuration

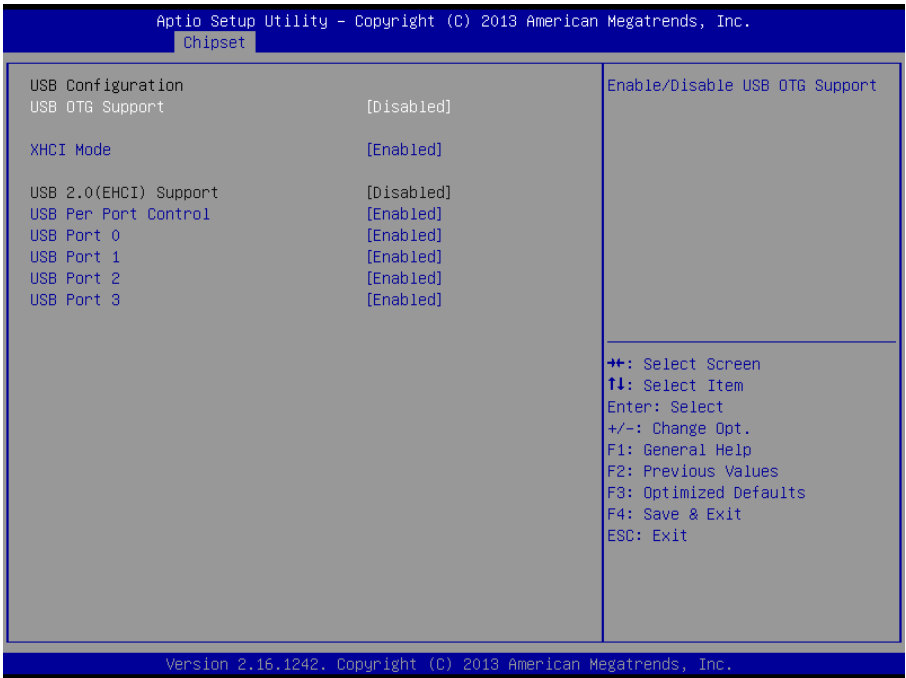

### 3.5.2.3 South Bridge: PCI Express Configuration

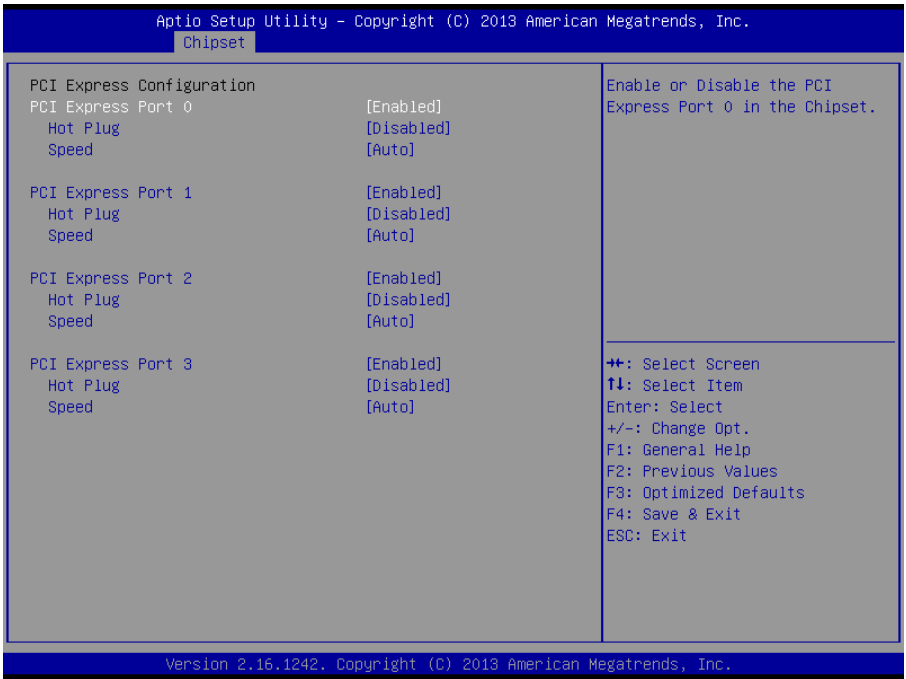

Options summary:

PCI Express Root Port 0	Disabled	Optimal Default, Failsafe Default
	Enabled	
Enabling/Disabling PCI Express root ports		
PCI Express Root Port x	Disabled Enabled	Optimal Default, Failsafe Default
	Auto	
Enabling/Disabling PCI Express root ports		

## 3.6 Setup submenu: Security

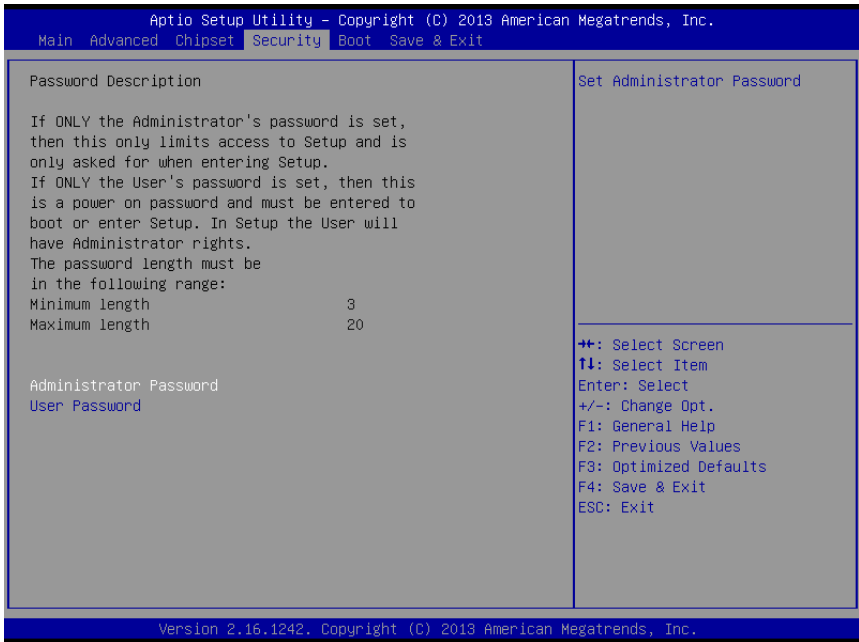

### Change User/Administrator Password

You can set a User Password once an Administrator Password is set. The password will be required during boot up, or when the user enters the Setup utility. Please Note that a User Password does not provide access to many of the features in the Setup utility.

Select the password you wish to set, press Enter to open a dialog box to enter your password (you can enter no more than six letters or numbers). Press Enter to confirm your entry, after which you will be prompted to retype your password for a final confirmation. Press Enter again after you have retyped it correctly.

### Removing the Password

Highlight this item and type in the current password. At the next dialog box press Enter to disable password protection.

### 3.7 Setup submenu: Boot



Options summary:

Quiet Boot	Disabled	Default
	Enabled	
En/Disable showing boot logo.		
Launch i210/i211 PXE OpROM	Disabled	Default
	Enabled	
En/Disable PXE boot for 8111E LAN		

### 3.8 Setup submenu: Save & Exit

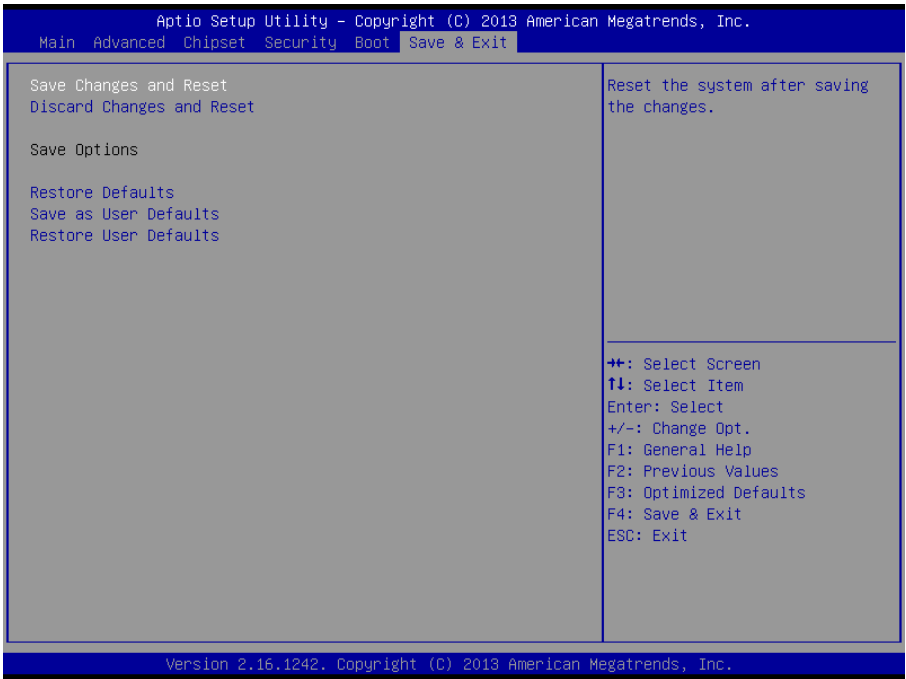

# Chapter 4

---

Drivers Installation



## 4.1 Product CD/DVD

---

The BOXER-6614 comes with a product DVD that contains all the drivers and utilities you need to setup your product. Insert the DVD and follow the steps in the autorun program to install the drivers.

In case the program does not start, follow the sequence below to install the drivers.

### Step 1 – Install Chipset Driver

1. Open the **Step1 - Chipset** folder and select your OS
2. Open the **SetupChipset.exe** file in the folder
3. Follow the instructions
4. Drivers will be installed automatically

### Step 2 – Install Graphics Driver

1. Open the **Step2 - Graphic** folder and select your OS
2. Open the **Setup.exe** file in the folder
3. Follow the instructions
4. Drivers will be installed automatically

### Step 3 – Install LAN Driver

1. Open the **Step3 - LAN** folder and select your OS
2. Open the **.exe** file in the folder
3. Follow the instructions
4. Drivers will be installed automatically

### Step 4 – Install Audio Driver

1. Open the **Step4 - Audio** folder and select your OS

2. followed by the **.exe** file in the folder
3. Follow the instructions
4. Drivers will be installed automatically

#### Step 5 – Install TXE Driver

1. Open the **Step5 - TXE** folder and select your OS
2. Open the **Setup.TXE.exe** file in the folder
3. Follow the instructions
4. Drivers will be installed automatically

#### Step 6 – Install TPM Driver

1. Open the **Step6 - TPM** folder followed by the **.exe** file in the folder
2. Follow the instructions
3. Drivers will be installed automatically

#### Step 7 – Install MBI Driver

1. Open the **Step7 - MBI** folder and select your OS
2. Open the **Setup.exe** file in the folder
3. Follow the instructions
4. Drivers will be installed automatically

## Step 8 – Install UART Drivers (Optional)

For Windows 7:

1. Change User Account Control settings to **Never notify**

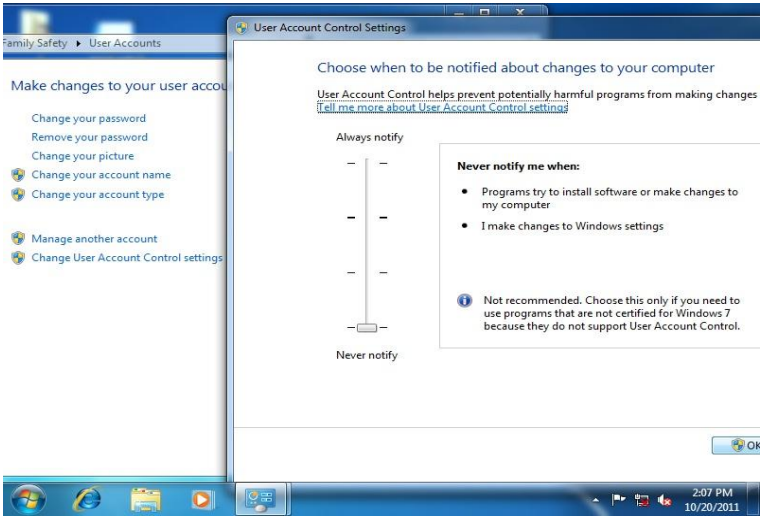

2. Reboot and log in as administrator

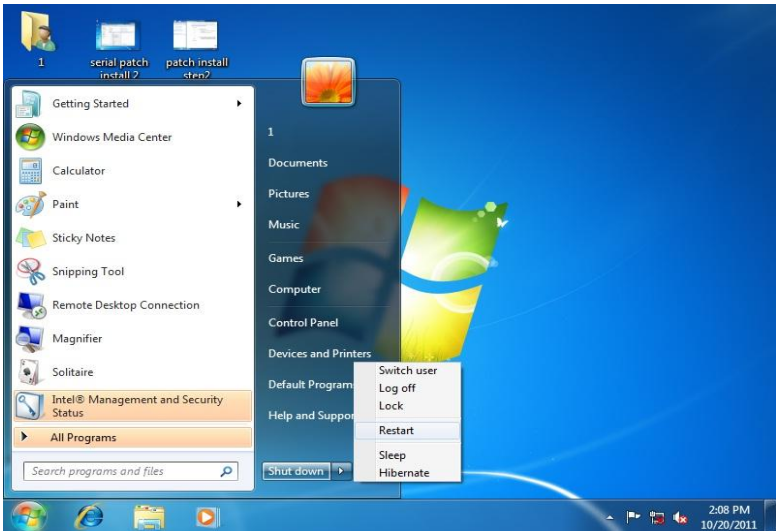

3. Run patch.bat as administrator

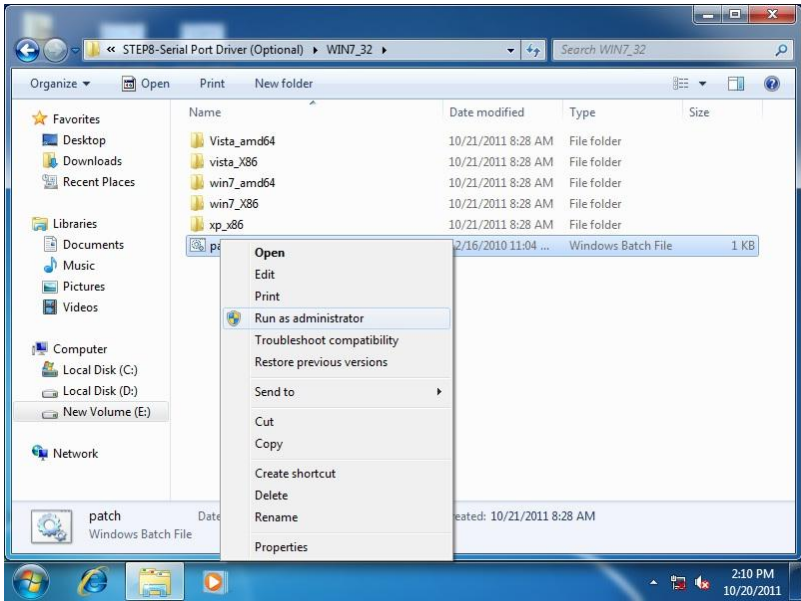

## For Windows 8:

1. Open the Apps Screen, right click on the **Command Prompt** tile and select **Run as Administrator**

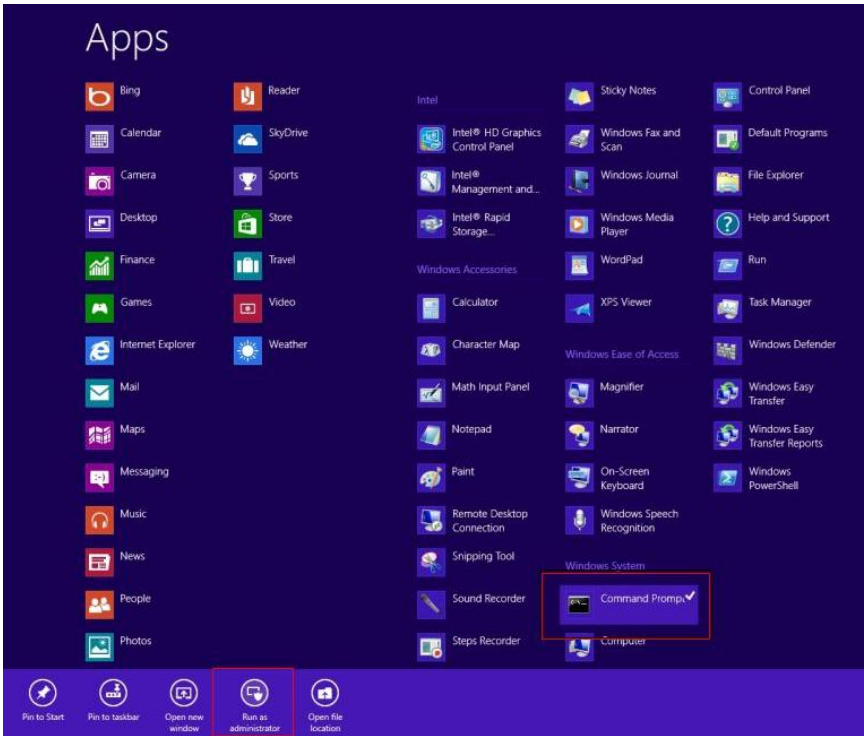

2. To install the driver (patch.bat), you will first have to locate the file in command prompt. To do that, go to the folder in which the file resides by entering **cd (file path)** eg: if the file is in a folder named abc in c drive, enter `cd c:\abc` (screenshot for reference only)
3. You are now at the folder where the file is located. Enter the **patch.bat** to open and install the drivers.

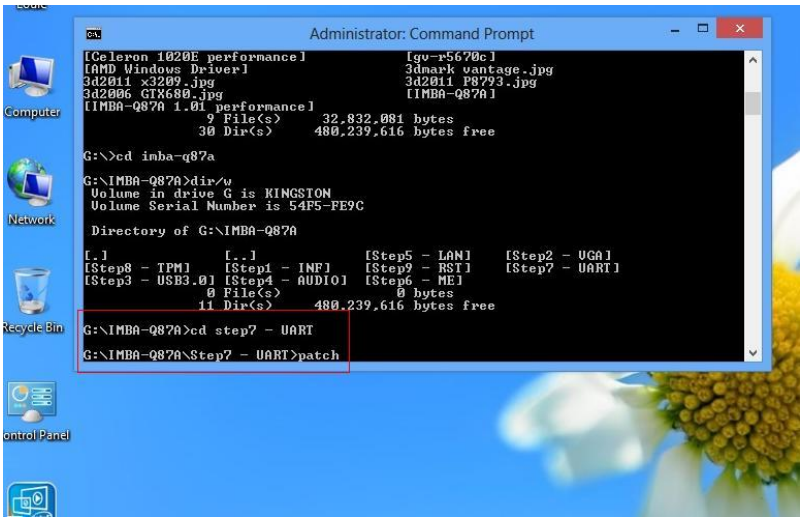

4. Reboot after installation completes.
5. To confirm the installation, go to Device Manager, expand the Ports (COM & LPT) tree and double click on any of the COM ports to open its properties. Go to the Driver tab, select Driver Details and click on **serial.sys**, you should see its provider as **Windows (R) Win 7 DDK Provider**.

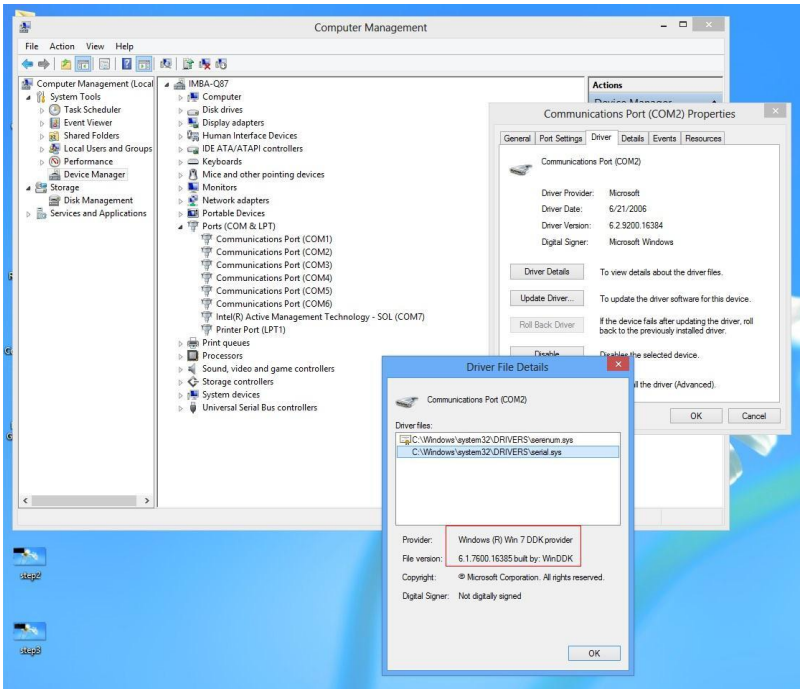

## For Windows 10:

1. You will need administrator rights to install the drivers. To get it, first go to **Computer Management in Control Panel** and double-click on **Administrator**

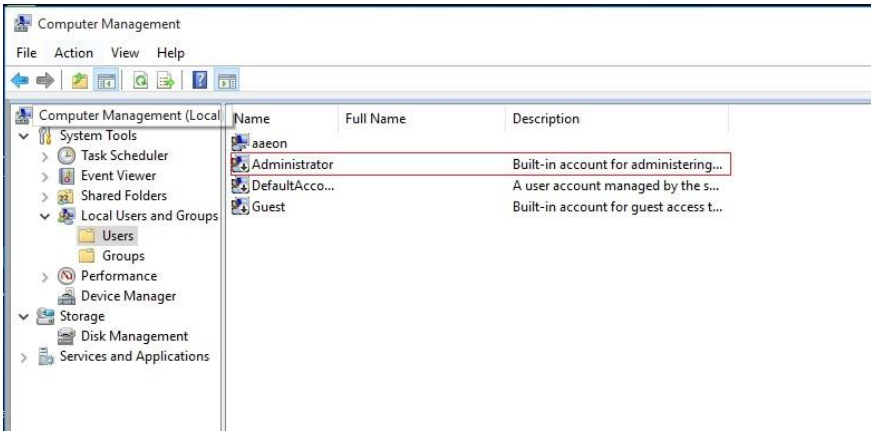

- In the dialog box, **uncheck** the **Account is disabled** option to enable administrator account.

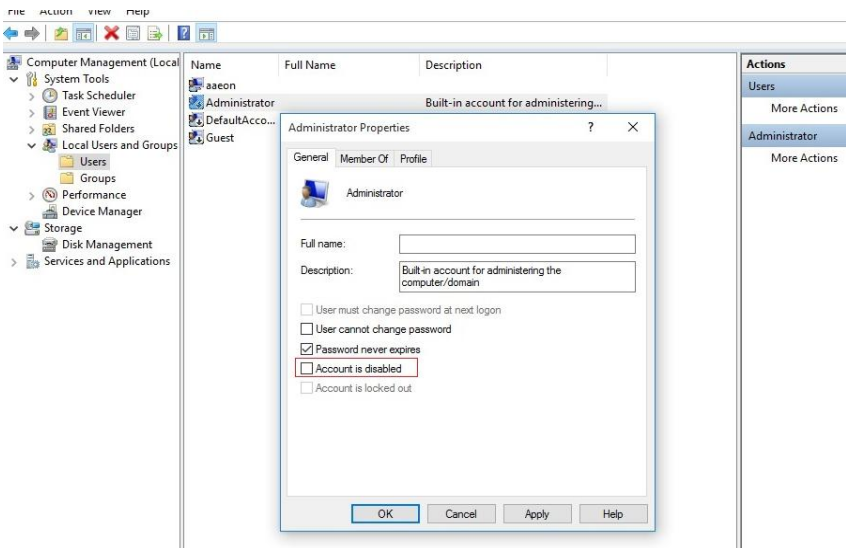

- Restart and sign in as the administrator (not password-protected by default)





4. Go back to the Windows 10 Serial Port drivers directory and run `patch.bat` as administrator.

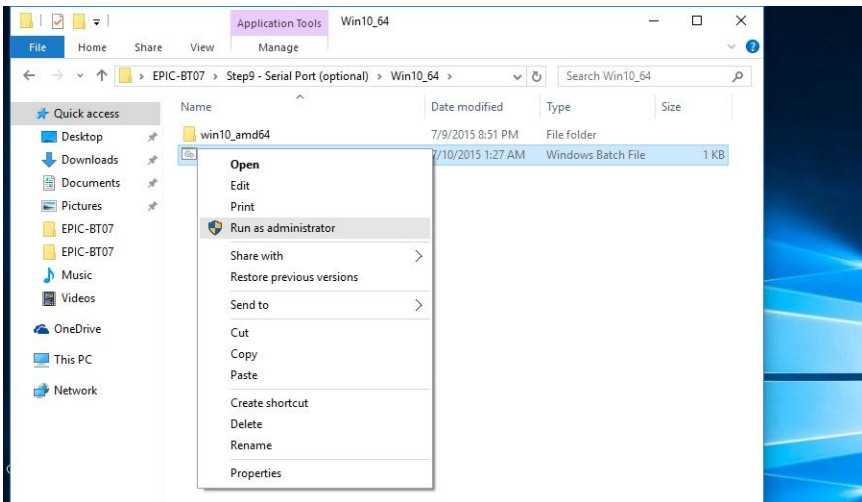

### Step 9 – Install USB3.0 Driver (Windows 7 only)

1. Open the **Step9 - USB3.0** folder followed by **Setup.exe**

2. Follow the instructions
3. Drivers will be installed automatically

# Appendix A

---

## Watchdog Timer Programming

## A.1 Watchdog Timer Registers

Table 1 : Watch dog relative IO address

I/O Base Address	Default Value	Note
	0xA00	I/O Base address for Watchdog operation. This address is assigned by SIO LDN7, register 0x60-0x61.

Table 2 : Watchdog relative register table

Register	Offset	BitNum	Value	Note
Watchdog WDTRST# Enable	0x00	7	1	Enable/Disable time out output via WDTRST# 0: Disable 1: Enable
Pulse Width	0x05	0:1	01	Width of Pulse signal 00: 1ms (do not use) 01: 25ms 10: 125ms 11: 5s <i>Pulse width is must longer than 16ms.</i>
Signal Polarity	0x05	2	0	0: low active 1: high active <i>Must set this bit to 0</i>
Counting Unit	0x05	3	0	Select time unit. 0: second 1: minute

Output Signal Type	0x05	4	1	0: Level 1: Pulse <i>Must set this bit to 1</i>
Watchdog Timer Enable	0x05	5	1	0: Disable 1: Enable
Timeout Status	0x05	6	1	1: timeout occurred. Write a 1 to clear timeout status
Timer Counter	0x06			Time of watchdog timer (0~255)

## A.2 Watchdog Sample Program

```
*****// WDT I/O
operation relative definition (Please reference to Table 1)
#define WDTAddr 0xA00 // WDT I/O base address
Void WDTWriteByte(byte Register, byte Value);
byte WDTReadByte(byte Register);
Void WDTSetReg(byte Register, byte Bit, byte Val);
// Watch Dog relative definition (Please reference to Table 2)
#define DevReg 0x00 // Device configuration register
#define WDRstBit 0x80 // Watchdog WDTRST# (Bit7)
#define WDRstVal 0x80 // Enabled WDTRST#
#define TimerReg 0x05 // Timer register
#define PSWidthBit 0x00 // WDTRST# Pulse width (Bit0:1)
#define PSWidthVal 0x01 // 25ms for WDTRST# pulse
#define PolarityBit 0x02 // WDTRST# Signal polarity (Bit2)
#define PolarityVal 0x00 // Low active for WDTRST#
#define UnitBit 0x03 // Unit for timer (Bit3)
#define ModeBit 0x04 // WDTRST# mode (Bit4)
#define ModeVal 0x01 // 0:level 1: pulse
#define EnableBit 0x05 // WDT timer enable (Bit5)
#define EnableVal 0x01 // 1: enable
#define StatusBit 0x06 // WDT timer status (Bit6)
#define CounterReg 0x06 // Timer counter register
*****
*****
VOID Main(){
// Procedure : AaeonWDTConfig
// (byte)Timer : Counter of WDT timer.(0x00~0xFF)
```

```

// (boolean)Unit : Select time unit(0: second, 1: minute).
AaeonWDTConfig(Counter, Unit);
// Procedure : AaeonWDTEnable
// This procedure will enable the WDT counting.
WDTSetBit(TimerReg, PSWidthBit, PSWidthVal);
// Watchdog WDRST# Enable
WDTSetBit(DevReg, WDTRstBit, WDTRstVal);
}
VOID WDTClearTimeoutStatus(){
WDTSetBit(TimerReg, StatusBit, 1);
}
*****

*****

VOID WDTWriteByte(byte Register, byte Value){
IOWriteByte(WDTAddr+Register, Value);
}
byte WDTReadByte(byte Register){
return IOReadByte(WDTAddr+Register);
}
VOID WDTSetBit(byte Register, byte Bit, byte Val){
byte TmpValue;
TmpValue = WDTReadByte(Register);
TmpValue &= ~(1 << Bit);
TmpValue |= Val << Bit;
WDTWriteByte(Register, TmpValue);
}
*****

```

# Appendix B

---

I/O Information



## B.1 I/O Address Map

Address Range	Device Name
[0000000000000000 - 000000000000006F]	PCI bus
[0000000000000020 - 0000000000000021]	Programmable interrupt controller
[0000000000000024 - 0000000000000025]	Programmable interrupt controller
[0000000000000028 - 0000000000000029]	Programmable interrupt controller
[000000000000002C - 000000000000002D]	Programmable interrupt controller
[000000000000002E - 000000000000002F]	Motherboard resources
[0000000000000030 - 0000000000000031]	Programmable interrupt controller
[0000000000000034 - 0000000000000035]	Programmable interrupt controller
[0000000000000038 - 0000000000000039]	Programmable interrupt controller
[000000000000003C - 000000000000003D]	Programmable interrupt controller
[0000000000000040 - 0000000000000043]	System timer
[000000000000004E - 000000000000004F]	Motherboard resources
[0000000000000050 - 0000000000000053]	System timer
[0000000000000061 - 0000000000000061]	Motherboard resources
[0000000000000063 - 0000000000000063]	Motherboard resources
[0000000000000065 - 0000000000000065]	Motherboard resources
[0000000000000067 - 0000000000000067]	Motherboard resources
[0000000000000070 - 0000000000000070]	Motherboard resources
[0000000000000070 - 0000000000000077]	System CMOS/real time clock
[0000000000000078 - 000000000000007F]	PCI bus
[0000000000000080 - 000000000000008F]	Motherboard resources
[0000000000000092 - 0000000000000092]	Motherboard resources
[00000000000000A0 - 00000000000000A1]	Programmable interrupt controller
[00000000000000A4 - 00000000000000A5]	Programmable interrupt controller
[00000000000000A8 - 00000000000000A9]	Programmable interrupt controller
[00000000000000AC - 00000000000000AD]	Programmable interrupt controller
[00000000000000B0 - 00000000000000B1]	Programmable interrupt controller
[00000000000000B2 - 00000000000000B3]	Motherboard resources
[00000000000000B4 - 00000000000000B5]	Programmable interrupt controller
[00000000000000B8 - 00000000000000B9]	Programmable interrupt controller
[00000000000000BC - 00000000000000BD]	Programmable interrupt controller
[00000000000000E8 - 00000000000000EF]	Communications Port (COM4)
[00000000000000F8 - 00000000000000FF]	Communications Port (COM2)
[0000000000000378 - 000000000000037F]	Printer Port (LPT1)
[00000000000003B0 - 00000000000003BB]	Intel(R) Atom(TM) Processor E3800 Series/Intel(R) Celeron(R) Processor N2920/J1900
[00000000000003C0 - 00000000000003DF]	Intel(R) Atom(TM) Processor E3800 Series/Intel(R) Celeron(R) Processor N2920/J1900
[0000000000000D00 - 000000000000DFFF]	Intel(R) Atom(TM)/Celeron(R)/Pentium(R) Processor PCI Express - Root Port 2 - 0F4A
[000000000000E000 - 000000000000EFFF]	Intel(R) Atom(TM)/Celeron(R)/Pentium(R) Processor PCI Express - Root Port 1 - 0F48
[000000000000F000 - 000000000000F01F]	Intel(R) Atom(TM)/Celeron(R)/Pentium(R) Processor Platform Control Unit - SMBus Port
[000000000000F020 - 000000000000F03F]	Intel(R) Atom(TM)/Celeron(R)/Pentium(R) Processor AHCI - 0F23
[000000000000F040 - 000000000000F043]	Intel(R) Atom(TM)/Celeron(R)/Pentium(R) Processor AHCI - 0F23
[000000000000F050 - 000000000000F057]	Intel(R) Atom(TM)/Celeron(R)/Pentium(R) Processor AHCI - 0F23
[000000000000F060 - 000000000000F063]	Intel(R) Atom(TM)/Celeron(R)/Pentium(R) Processor AHCI - 0F23
[000000000000F070 - 000000000000F077]	Intel(R) Atom(TM)/Celeron(R)/Pentium(R) Processor AHCI - 0F23
[000000000000F080 - 000000000000F087]	Intel(R) Atom(TM) Processor E3800 Series/Intel(R) Celeron(R) Processor N2920/J1900

## B.2 Memory Address Map























































































The image shows a screenshot of the Windows System Information tool, specifically the 'Memory' section. It displays a list of memory addresses and their corresponding hardware components. The list includes various Intel processors, PCI buses, network connections, and motherboard resources.

Memory Address	Hardware Component
[00000000000A0000 - 00000000000BFFFF]	Intel(R) Atom(TM) Processor E3800 Series/Intel(R) Celeron(R) Processor N2920/J1900
[00000000000A0000 - 00000000000BFFFF]	PCI bus
[00000000000C0000 - 00000000000DFFFF]	PCI bus
[00000000000E0000 - 00000000000FFFFFF]	PCI bus
[00000000000E0000 - 00000000000FFFFFF]	Intel(R) Atom(TM) Processor E3800 Series/Intel(R) Celeron(R) Processor N2920/J1900
[00000000000E0000 - 00000000000D816FFF]	PCI bus
[0000000000000000 - 000000000003FFFFFF]	Intel(R) Atom(TM) Processor E3800 Series/Intel(R) Celeron(R) Processor N2920/J1900
[00000000000400000 - 000000000004FFFFFF]	Intel(R) Atom(TM)/Celeron(R)/Pentium(R) Processor Trusted Execution Engine Interface -
[00000000000500000 - 000000000005FFFFFF]	Intel(R) Atom(TM)/Celeron(R)/Pentium(R) Processor Trusted Execution Engine Interface -
[00000000000600000 - 0000000000061FFFF]	Intel(R) I211 Gigabit Network Connection
[00000000000600000 - 0000000000066FFFF]	Intel(R) Atom(TM)/Celeron(R)/Pentium(R) Processor PCI Express - Root Port 2 - 0F4A
[00000000000620000 - 00000000000623FFF]	Intel(R) I211 Gigabit Network Connection
[00000000000700000 - 0000000000071FFFF]	Intel(R) I211 Gigabit Network Connection #2
[00000000000700000 - 0000000000077FFFF]	Intel(R) Atom(TM)/Celeron(R)/Pentium(R) Processor PCI Express - Root Port 1 - 0F48
[00000000000720000 - 00000000000723FFF]	Intel(R) I211 Gigabit Network Connection #2
[00000000000800000 - 0000000000080FFFF]	Intel(R) USB 3.0 eXtensible Host Controller
[00000000000810000 - 00000000000813FFF]	High Definition Audio Controller
[00000000000814000 - 0000000000081401F]	Intel(R) Atom(TM)/Celeron(R)/Pentium(R) Processor Platform Control Unit - SMBus Port
[00000000000816000 - 000000000008167FF]	Intel(R) Atom(TM)/Celeron(R)/Pentium(R) Processor AHCI - 0F23
[00000000000E000000 - 00000000000EFFFFFF]	Motherboard resources
[00000000000FED00000 - 00000000000FED003FF]	High precision event timer
[00000000000FED01000 - 00000000000FED01FFF]	Motherboard resources
[00000000000FED03000 - 00000000000FED03FFF]	Motherboard resources
[00000000000FED04000 - 00000000000FED04FFF]	Motherboard resources
[00000000000FED08000 - 00000000000FED08FFF]	Motherboard resources
[00000000000FED0C000 - 00000000000FED0FFFF]	Motherboard resources
[00000000000FED1C000 - 00000000000FED1CFFF]	Motherboard resources
[00000000000FEE00000 - 00000000000FEEFFFFFF]	Motherboard resources
[00000000000FEF00000 - 00000000000FEFFFFFF]	Motherboard resources
[00000000000FF000000 - 00000000000FFFFFFFF]	Intel(R) 82802 Firmware Hub Device

## B.3 IRQ Mapping Chart

Device	IRQ
System timer	(00)
Communications Port (COM2)	(03)
Communications Port (COM1)	(04)
High precision event timer	(08)
Communications Port (COM3)	(10)
Communications Port (COM4)	(10)
Microsoft ACPI-Compliant System	(81)
Microsoft ACPI-Compliant System	(82)
Microsoft ACPI-Compliant System	(83)
Microsoft ACPI-Compliant System	(84)
Microsoft ACPI-Compliant System	(85)
Microsoft ACPI-Compliant System	(86)
Microsoft ACPI-Compliant System	(87)
Microsoft ACPI-Compliant System	(88)
Microsoft ACPI-Compliant System	(89)
Microsoft ACPI-Compliant System	(90)
Microsoft ACPI-Compliant System	(91)
Microsoft ACPI-Compliant System	(92)
Microsoft ACPI-Compliant System	(93)
Microsoft ACPI-Compliant System	(94)
Microsoft ACPI-Compliant System	(95)
Microsoft ACPI-Compliant System	(96)
Microsoft ACPI-Compliant System	(97)
Microsoft ACPI-Compliant System	(98)
Microsoft ACPI-Compliant System	(99)
Microsoft ACPI-Compliant System	(100)
Microsoft ACPI-Compliant System	(101)
Microsoft ACPI-Compliant System	(102)
Microsoft ACPI-Compliant System	(103)
Microsoft ACPI-Compliant System	(104)
Microsoft ACPI-Compliant System	(105)
Microsoft ACPI-Compliant System	(106)
Microsoft ACPI-Compliant System	(107)
Microsoft ACPI-Compliant System	(108)
Microsoft ACPI-Compliant System	(109)
Microsoft ACPI-Compliant System	(110)
Microsoft ACPI-Compliant System	(111)
Microsoft ACPI-Compliant System	(112)
Microsoft ACPI-Compliant System	(113)
Microsoft ACPI-Compliant System	(114)
Microsoft ACPI-Compliant System	(115)
Microsoft ACPI-Compliant System	(116)
Microsoft ACPI-Compliant System	(117)
Microsoft ACPI-Compliant System	(118)
Microsoft ACPI-Compliant System	(119)
Microsoft ACPI-Compliant System	(120)
Microsoft ACPI-Compliant System	(121)
Microsoft ACPI-Compliant System	(122)
Microsoft ACPI-Compliant System	(123)
Microsoft ACPI-Compliant System	(124)
Microsoft ACPI-Compliant System	(125)

	(ISA) 0x0000007E (126)	Microsoft ACPI-Compliant System
	(ISA) 0x0000007F (127)	Microsoft ACPI-Compliant System
	(ISA) 0x00000080 (128)	Microsoft ACPI-Compliant System
	(ISA) 0x00000081 (129)	Microsoft ACPI-Compliant System
	(ISA) 0x00000082 (130)	Microsoft ACPI-Compliant System
	(ISA) 0x00000083 (131)	Microsoft ACPI-Compliant System
	(ISA) 0x00000084 (132)	Microsoft ACPI-Compliant System
	(ISA) 0x00000085 (133)	Microsoft ACPI-Compliant System
	(ISA) 0x00000086 (134)	Microsoft ACPI-Compliant System
	(ISA) 0x00000087 (135)	Microsoft ACPI-Compliant System
	(ISA) 0x00000088 (136)	Microsoft ACPI-Compliant System
	(ISA) 0x00000089 (137)	Microsoft ACPI-Compliant System
	(ISA) 0x0000008A (138)	Microsoft ACPI-Compliant System
	(ISA) 0x0000008B (139)	Microsoft ACPI-Compliant System
	(ISA) 0x0000008C (140)	Microsoft ACPI-Compliant System
	(ISA) 0x0000008D (141)	Microsoft ACPI-Compliant System
	(ISA) 0x0000008E (142)	Microsoft ACPI-Compliant System
	(ISA) 0x0000008F (143)	Microsoft ACPI-Compliant System
	(ISA) 0x00000090 (144)	Microsoft ACPI-Compliant System
	(ISA) 0x00000091 (145)	Microsoft ACPI-Compliant System
	(ISA) 0x00000092 (146)	Microsoft ACPI-Compliant System
	(ISA) 0x00000093 (147)	Microsoft ACPI-Compliant System
	(ISA) 0x00000094 (148)	Microsoft ACPI-Compliant System
	(ISA) 0x00000095 (149)	Microsoft ACPI-Compliant System
	(ISA) 0x00000096 (150)	Microsoft ACPI-Compliant System
	(ISA) 0x00000097 (151)	Microsoft ACPI-Compliant System
	(ISA) 0x00000098 (152)	Microsoft ACPI-Compliant System
	(ISA) 0x00000099 (153)	Microsoft ACPI-Compliant System
	(ISA) 0x0000009A (154)	Microsoft ACPI-Compliant System
	(ISA) 0x0000009B (155)	Microsoft ACPI-Compliant System
	(ISA) 0x0000009C (156)	Microsoft ACPI-Compliant System
	(ISA) 0x0000009D (157)	Microsoft ACPI-Compliant System
	(ISA) 0x0000009E (158)	Microsoft ACPI-Compliant System
	(ISA) 0x0000009F (159)	Microsoft ACPI-Compliant System
	(ISA) 0x000000A0 (160)	Microsoft ACPI-Compliant System
	(ISA) 0x000000A1 (161)	Microsoft ACPI-Compliant System
	(ISA) 0x000000A2 (162)	Microsoft ACPI-Compliant System
	(ISA) 0x000000A3 (163)	Microsoft ACPI-Compliant System
	(ISA) 0x000000A4 (164)	Microsoft ACPI-Compliant System
	(ISA) 0x000000A5 (165)	Microsoft ACPI-Compliant System
	(ISA) 0x000000A6 (166)	Microsoft ACPI-Compliant System
	(ISA) 0x000000A7 (167)	Microsoft ACPI-Compliant System
	(ISA) 0x000000A8 (168)	Microsoft ACPI-Compliant System
	(ISA) 0x000000A9 (169)	Microsoft ACPI-Compliant System
	(ISA) 0x000000AA (170)	Microsoft ACPI-Compliant System
	(ISA) 0x000000AB (171)	Microsoft ACPI-Compliant System
	(ISA) 0x000000AC (172)	Microsoft ACPI-Compliant System
	(ISA) 0x000000AD (173)	Microsoft ACPI-Compliant System
	(ISA) 0x000000AE (174)	Microsoft ACPI-Compliant System
	(ISA) 0x000000AF (175)	Microsoft ACPI-Compliant System
	(ISA) 0x000000B0 (176)	Microsoft ACPI-Compliant System
	(ISA) 0x000000B1 (177)	Microsoft ACPI-Compliant System
	(ISA) 0x000000B2 (178)	Microsoft ACPI-Compliant System
	(ISA) 0x000000B3 (179)	Microsoft ACPI-Compliant System
	(ISA) 0x000000B4 (180)	Microsoft ACPI-Compliant System

	(ISA) 0x00000085 (181)	Microsoft ACPI-Compliant System
	(ISA) 0x00000086 (182)	Microsoft ACPI-Compliant System
	(ISA) 0x00000087 (183)	Microsoft ACPI-Compliant System
	(ISA) 0x00000088 (184)	Microsoft ACPI-Compliant System
	(ISA) 0x00000089 (185)	Microsoft ACPI-Compliant System
	(ISA) 0x0000008A (186)	Microsoft ACPI-Compliant System
	(ISA) 0x0000008B (187)	Microsoft ACPI-Compliant System
	(ISA) 0x0000008C (188)	Microsoft ACPI-Compliant System
	(ISA) 0x0000008D (189)	Microsoft ACPI-Compliant System
	(ISA) 0x0000008E (190)	Microsoft ACPI-Compliant System
	(PCI) 0x0000000B (11)	Intel(R) Atom(TM)/Celeron(R)/Pentium(R) Processor Platform Control Unit - SMBus Port - 0F12
	(PCI) 0x00000010 (16)	Intel(R) Atom(TM)/Celeron(R)/Pentium(R) Processor PCI Express - Root Port 1 - 0F48
	(PCI) 0x00000011 (17)	Intel(R) Atom(TM)/Celeron(R)/Pentium(R) Processor PCI Express - Root Port 2 - 0F4A
	(PCI) 0x00000013 (19)	Intel(R) Atom(TM)/Celeron(R)/Pentium(R) Processor AHCI - 0F23
	(PCI) 0x00000016 (22)	High Definition Audio Controller
	(PCI) 0xFFFFFFFF1 (-15)	Intel(R) I211 Gigabit Network Connection
	(PCI) 0xFFFFFFFF2 (-14)	Intel(R) I211 Gigabit Network Connection
	(PCI) 0xFFFFFFFF3 (-13)	Intel(R) I211 Gigabit Network Connection
	(PCI) 0xFFFFFFFF4 (-12)	Intel(R) I211 Gigabit Network Connection
	(PCI) 0xFFFFFFFF5 (-11)	Intel(R) I211 Gigabit Network Connection
	(PCI) 0xFFFFFFFF6 (-10)	Intel(R) I211 Gigabit Network Connection
	(PCI) 0xFFFFFFFF7 (-9)	Intel(R) I211 Gigabit Network Connection #2
	(PCI) 0xFFFFFFFF8 (-8)	Intel(R) I211 Gigabit Network Connection #2
	(PCI) 0xFFFFFFFF9 (-7)	Intel(R) I211 Gigabit Network Connection #2
	(PCI) 0xFFFFFFFFA (-6)	Intel(R) I211 Gigabit Network Connection #2
	(PCI) 0xFFFFFFFFB (-5)	Intel(R) I211 Gigabit Network Connection #2
	(PCI) 0xFFFFFFFFC (-4)	Intel(R) I211 Gigabit Network Connection #2
	(PCI) 0xFFFFFFFFD (-3)	Intel(R) USB 3.0 eXtensible Host Controller
	(PCI) 0xFFFFFFFFE (-2)	Intel(R) Atom(TM) Processor E3800 Series/Intel(R) Celeron(R) Processor N2920/J1900

## B.4 DMA Channel Assignments

---

