

BOXER-6406U-ADN

Fanless Embedded Box PC

User's Manual 2nd Ed

Copyright Notice

This document is copyrighted, 2024. All rights are reserved. The original manufacturer reserves the right to make improvements to the products described in this manual at any time without notice.

No part of this manual may be reproduced, copied, translated, or transmitted in any form or by any means without the prior written permission of the original manufacturer. Information provided in this manual is intended to be accurate and reliable. However, the original manufacturer assumes no responsibility for its use, or for any infringements upon the rights of third parties that may result from its use.

The material in this document is for product information only and is subject to change without notice. While reasonable efforts have been made in the preparation of this document to assure its accuracy, AAEON assumes no liabilities resulting from errors or omissions in this document, or from the use of the information contained herein.

AAEON reserves the right to make changes in the product design without notice to its users.

Acknowledgement

All other product name or trademarks are properties of their respective owners.

- Microsoft Windows®, Windows® 10, and Windows® 11 are registered trademarks of Microsoft Corp.
- Intel® and Atom® are registered trademarks of Intel Corporation.
- Linux® is a registered trademark of Linus Torvalds in the U.S. and other countries.
- Ubuntu and Canonical are registered trademarks of Canonical Ltd.

All other product names or trademarks are properties of their respective owners. The publisher of this document does not assume nor imply ownership of any trademarked product not listed herein.

Packing List

Before setting up your product, please make sure the following items have been shipped:

Item	Quantity
● BOXER-6406U-ADN	1
● Wall Mount Bracket	2
● 60W 12V Power Adapter	1
● Screw Pack	1

If any of these items are missing or damaged, please contact your distributor or sales representative immediately.

About this Document

This User's Manual contains all the essential information, such as detailed descriptions and explanations on the product's hardware and software features (if any), its specifications, dimensions, jumper/connector settings/definitions, and driver installation instructions (if any), to facilitate users in setting up their product.

Users may refer to the product page at AAEON.com for the latest version of this document.

Safety Precautions

Please read the following safety instructions carefully. It is advised that you keep this manual for future references

1. All cautions and warnings on the device should be noted.
2. Make sure the power source matches the power rating of the device.
3. Position the power cord so that people cannot step on it. Do not place anything over the power cord.
4. Always completely disconnect the power before working on the system's hardware.
5. No connections should be made when the system is powered as a sudden rush of power may damage sensitive electronic components.
6. If the device is not to be used for a long time, disconnect it from the power supply to avoid damage by transient over-voltage.
7. Always disconnect this device from any power supply before cleaning.
8. While cleaning, use a damp cloth instead of liquid or spray detergents.
9. Make sure the device is installed near a power outlet and is easily accessible.
10. Keep this device away from humidity.
11. Place the device on a solid surface during installation to prevent falls.
12. Do not cover the openings on the device to ensure optimal heat dissipation.
13. Watch out for high temperatures when the system is running.
14. Do not touch the heat sink or heat spreader when the system is running
15. Never pour any liquid into the openings. This could cause fire or electric shock.
16. As most electronic components are sensitive to static electrical charge, be sure to ground yourself to prevent static charge when installing the internal components. Use a grounding wrist strap and contain all electronic components in any static-shielded containers.

17. If any of the following situations arises, please contact our service personnel:
 - i. Damaged power cord or plug
 - ii. Liquid intrusion to the device
 - iii. Exposure to moisture
 - iv. Device is not working as expected or in a manner as described in this manual
 - v. The device is dropped or damaged
 - vi. Any obvious signs of damage displayed on the device
18. Do not leave this device in an uncontrolled environment with temperatures beyond the device's permitted storage temperatures (see chapter 1) to prevent damage.
19. Do NOT disassemble the motherboard so as not to damage the system or void your warranty.
20. If the thermal pad had been damaged, please contact AAEON's salesperson to purchase a new one. Do NOT use those of other brands.
21. The Hex Cylinder Coppers on the front panel are not removable.
22. Repeatedly assemble and disassemble the system may cause damages to the exterior paint and surface and screw holes.
23. Use the right size screwdriver.
24. Use the screwdriver correctly to remove screws from the system.

FCC Statement

Warning!



This device complies with Part 15 FCC Rules. Operation is subject to the following two conditions: (1) this device may not cause harmful interference, and (2) this device must accept any interference received including interference that may cause undesired operation.

Caution:

There is a danger of explosion if the battery is incorrectly replaced. Replace only with the same or equivalent type recommended by the manufacturer. Dispose of used batteries according to the manufacturer's instructions and your local government's recycling or disposal directives.

Attention:

Il y a un risque d'explosion si la batterie est remplacée de façon incorrecte. Ne la remplacer qu'avec le même modèle ou équivalent recommandé par le constructeur. Recycler les batteries usées en accord avec les instructions du fabricant et les directives gouvernementales de recyclage.

产品中有毒有害物质或元素名称及含量

AAEON System

QO4-381 Rev.A0

部件名称	有毒有害物质或元素					
	铅 (Pb)	汞 (Hg)	镉 (Cd)	六价铬 (Cr(VI))	多溴联苯 (PBB)	多溴二苯 醚(PBDE)
印刷电路板 及其电子组件	×	○	○	○	○	○
外部信号 连接器及线材	×	○	○	○	○	○
外壳	○	○	○	○	○	○
中央处理器 与内存	×	○	○	○	○	○
硬盘	×	○	○	○	○	○
液晶模块	×	×	○	○	○	○
光驱	×	○	○	○	○	○
触控模块	×	○	○	○	○	○
电源	×	○	○	○	○	○
电池	×	○	○	○	○	○

本表格依据 SJ/T 11364 的规定编制。

○：表示该有毒有害物质在该部件所有均质材料中的含量均在 GB/T 26572 标准规定的限量要求以下。

×：表示该有害物质的某一均质材料超出了 GB/T 26572 的限量要求，然而该部件

仍符合欧盟指令 2011/65/EU 的规范。

备注：

- 一、此产品所标示之环保使用期限，系指在一般正常使用状况下。
- 二、上述部件物质中央处理器、内存、硬盘、光驱、电源为选购品。
- 三、上述部件物质液晶模块、触控模块仅一体机产品适用。

Hazardous and Toxic Materials List

AAEON System

QO4-381 Rev.A0

Component Name	Hazardous or Toxic Materials or Elements					
	Lead (Pb)	Mercury (Hg)	Cadmium (Cd)	Hexavalent Chromium (Cr(VI))	Polybrominated biphenyls (PBBS)	Polybrominated ethers (PBDES)
PCB and Components	X	O	O	O	O	O
Wires & Connectors for Ext.Connections	X	O	O	O	O	O
Chassis	O	O	O	O	O	O
CPU & RAM	X	O	O	O	O	O
HDD Drive	X	O	O	O	O	O
LCD Module	X	X	O	O	O	O
Optical Drive	X	O	O	O	O	O
Touch Control Module	X	O	O	O	O	O
PSU	X	O	O	O	O	O
Battery	X	O	O	O	O	O

This form is prepared in compliance with the provisions of SJ/T 11364.

O: The level of toxic or hazardous materials present in this component and its parts is below the limit specified by GB/T 26572.

X: The level of toxic of hazardous materials present in the component exceed the limits specified by GB/T 26572, but is still in compliance with EU Directive 2011/65/EU (RoHS 2).

Notes:

1. The Environment Friendly Use Period indicated by labelling on this product is applicable only to use under normal conditions.
2. Individual components including the CPU, RAM/memory, HDD, optical drive, and PSU are optional.
3. LCD Module and Touch Control Module only applies to certain products which feature these components.

Table of Contents

- Chapter 1 - Product Specifications 1
 - 1.1 Specifications..... 2
- Chapter 2 – Hardware Information 5
 - 2.1 Dimensions 6
 - 2.2 Jumpers and Connectors..... 8
 - 2.3 List of Jumpers 9
 - 2.3.1 Setting Jumpers 9
 - 2.3.2 ATX/AT Mode Selection (JP3)..... 10
 - 2.3.3 CMOS Control Selection (JP1) 10
 - 2.4 List of Connectors 11
 - 2.4.1 Audio Box Connector (CN34) 13
 - 2.4.2 Dual HDMI Port (CN40) 14
 - 2.4.3 Dual USB 3.2 Port (CN29) 15
 - 2.4.4 Dual USB 2.0 Port (CN38) 16
 - 2.4.5 RJ-45 LAN (CN4/CN5) 17
 - 2.4.6 M.2 2280 M-Key (CN25) 17
 - 2.4.7 Full Size Mini Card (CN2) 19
 - 2.4.8 Debug Card Connector (CN12) 21
 - 2.4.9 SATA Connector (CN14)..... 22
 - 2.4.10 SATA PWR Connector (CN15)..... 23
 - 2.4.11 DIO Port (CN39) 23
 - 2.4.12 DIO Box Connector (CN45)..... 24
 - 2.4.13 COM Port 1 ~ 3 (RS-232/422/485) (CN17, CN18, CN21)..... 25
 - 2.4.14 COM 1 Box Connector (Optional) (CN19)..... 25
 - 2.4.15 COM 2 Box Connector (Optional) (CN20) 26
 - 2.4.16 COM 3 Box Connector (Optional) (CN23) 27

2.4.17	COM 4 Box Connector (Optional) (CN24)	28
2.4.18	M.2 2230 E-Key (CN26)	29
2.4.19	USB 2.0 Wafer Box Connector (CN31/CN32)	30
2.5	Hardware Assembly	31
2.5.1	2.5" SATA Drive Installation	31
2.5.2	M.2 Module Installation	33
2.5.3	DIMM Heatsink Installation	34
2.5.4	Wall Mount Installation	35
Chapter 3 - AMI BIOS Setup		36
3.1	System Test and Initialization	37
3.2	AMI BIOS Setup	38
3.3	Setup Submenu: Main	39
3.4	Setup Submenu: Advanced	40
3.4.1	CPU Configuration	41
3.4.2	Memory Configuration	42
3.4.3	PCH-FW Configuration	43
3.4.3.1	Firmware Update Configuration	44
3.4.4	Hardware Monitor	45
3.4.5	Power Management	46
3.4.6	AAEON BIOS Robot	47
3.4.6.1	Device Detecting Configuration	48
3.5	Setup Submenu: System I/O	54
3.5.1	Storage Configuration	55
3.5.2	HD Audio Configuration	56
3.5.3	Digital IO Port Configuration	57
3.5.4	Legacy Logical Devices Configuration	58
3.5.4.1	Serial Port 1	59
3.5.4.2	Serial Port 2	60

3.5.5	Serial Port Console Redirection	61
3.5.5.1	Console Redirection Settings (COM0)	62
3.5.5.2	Console Redirection Settings (Out-of-Band Mgmt Port).....	64
3.6	Setup Submenu: Security	66
3.6.1	Trusted Computing.....	67
3.6.2	Secure Boot	69
3.6.2.1	Key Management	70
3.7	Setup Submenu: Boot	72
3.7.1	UEFI BBS Priorities	73
3.8	Setup Submenu: Save & Exit	74
Chapter 4	– Drivers Installation	75
4.1	Drivers Download and Installation.....	76
Appendix A	– I/O Information	78
A.1	I/O Address Map	79
A.2	Memory Address Map	80
A.3	Large Memory Address Map.....	81
A.4	IRQ Mapping Chart	82

Chapter 1

Product Specifications

1.1 Specifications

System

CPU	Intel Atom® Processor X Series/Intel® Processor N-series Processors: Intel Atom® x7211E Processor Intel® Processor N200 Intel® Processor N50
Chipset	Intel® SoC
System Memory	DDR5 4800MHz SODIMM x 1, up to 32GB
Display Interface	HDMI 2.0 x 2
Storage	M.2 2280 M-Key x 1 (PCIe Gen 3 [x2]) 2.5" SATA HDD/SSD x 1
Ethernet	RJ-45 x 2 for 2.5GbE LAN (Intel® Ethernet Controller I226-LM)
I/O	HDMI x 2 RJ-45 x 2 for 2.5GbE LAN (Intel® Ethernet Controller I226-LM) USB 3.2 Gen 2 (Type-A) x 2 USB 2.0 (Type-A) x 2 DB-9 x 2 for RS-232/422/485 DB-15 x 1 Male for 8-Channel Digital I/O 12V DC Jack Input Power Button with LED x 1 Antenna Opening x 4
Expansion	M.2 2280 M-Key x 1 (PCIe [x2]) M.2 2230 E-Key x 1 Full-size Mini Card x 1 (PCIe + USB)

System

	SIM Slot x 1
Indicator	Power Button x 1 with LED
Security	Onboard TPM 2.0
OS Support	Windows® 10 IoT Ent LTSC Windows® 11 Pro Ubuntu 22.04

Power Supply

Power Requirement	Lockable DC Jack x 1 for 12V DC-in
--------------------------	------------------------------------

Mechanical

Mounting	Wall Mount
Dimensions	Without Bracket: 6.46" x 4.11" x 1.85" (164mm x 104.5mm x 47mm) With Bracket: 8.74" x 4.11" x 2.13" (222mm x 104.5mm x 54mm)
Gross Weight	3.8 lb. (1.73Kg)
Net Weight	2 lb. (0.93Kg)

Environmental

Operating Temperature	-4°F ~ 140°F (-20°C ~ 60°C), according to IEC68-2 with 0.7 m/s AirFlow (w/ Industrial wide Temp. SSD/RAM)
Storage Temperature	-40°F ~ 176°F (-40°C ~ 80°C)
Storage Humidity	5% ~ 95% @40°C, non-condensing
Anti-Vibration	With SSD: Random, 3 Grms, 5~500Hz
Anti-Shock	With SSD: 50 G, IEC 60068-2-27, half sine, 11 ms duration

Environmental

Drop	30" (760mm), 1 Corner, 3 Edge, 6 Surface
Certification	CE/FCC Class A

Note: Industrial grade memory modules are recommended (temperature range: -40°F ~ 185°F (-40°C ~ 85°C) or above).

Note: For Gen 4 storage module, a thermal solution is mandatory for heat-dissipation. Please check with your AAEON representative if you have any queries regarding this requirement.

Chapter 2

Hardware Information

2.1 Dimensions

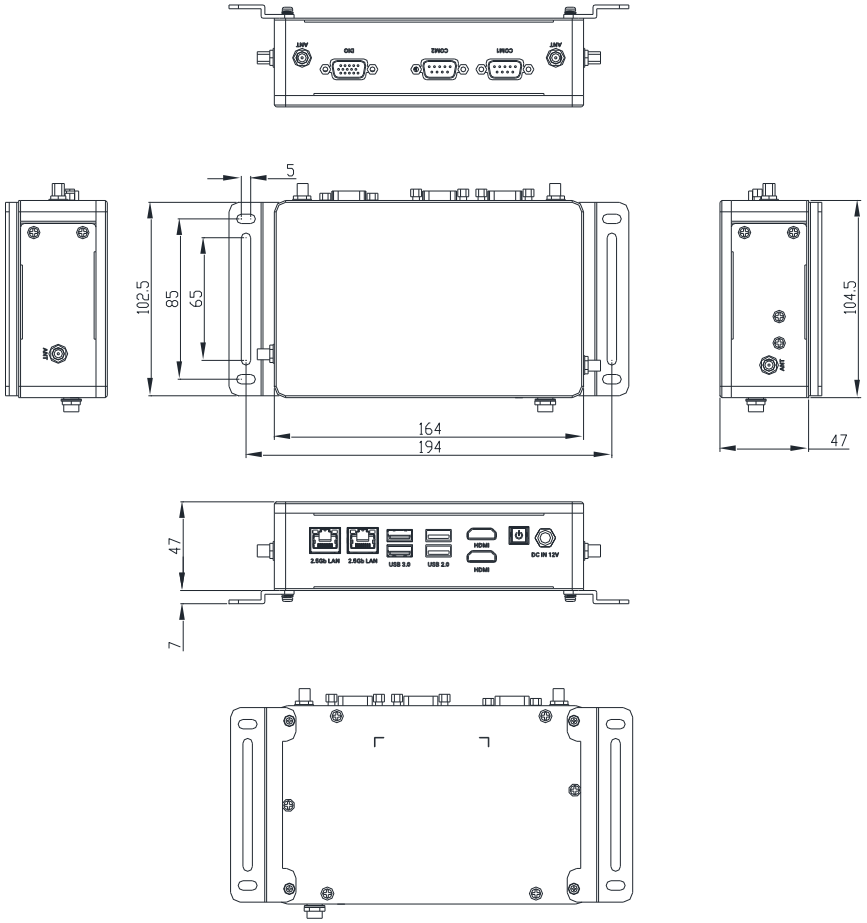

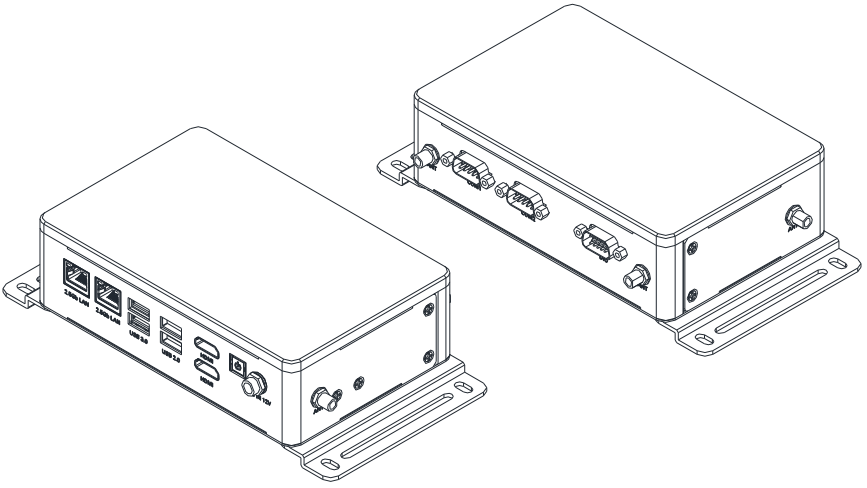

2.2 Jumpers and Connectors

Fanless Embedded Box PC

BOXER-6406U-ADN

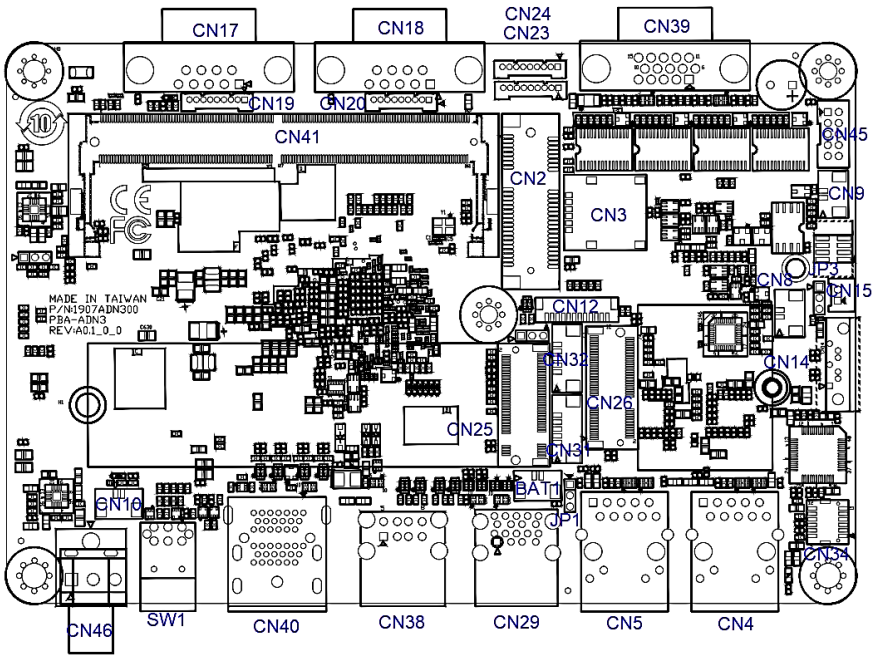

2.3 List of Jumpers

The board has a number of jumpers that allow you to configure your system to suit your application.

The table below shows the function of each of the board's jumpers

Label	Function
JP3	ATX/AT Mode Selection
JP1	CMOS Control Selection

2.3.1 Setting Jumpers

You can configure your system to match the needs of your application by setting jumpers. A jumper is the simplest kind of electric switch. It consists of two metal pins and a small metal clip (often protected by a plastic cover) that slides over the pins to connect them. To “close” a jumper you connect the pins with the clip.

To “open” a jumper you remove the clip. Sometimes a jumper will have three pins, labeled 1, 2 and 3. In this case you would connect either pins 1 and 2 or 2 and 3.

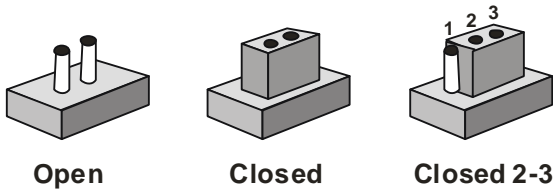

A pair of needle-nose pliers may be helpful when working with jumpers.

If you have any questions about the best hardware configuration for your application, contact your local distributor or sales representative before you make any changes.

Generally, you simply need a standard cable to make most connections.

2.3.2 ATX/AT Mode Selection (JP3)

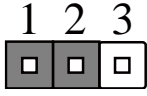

ATX (Default)

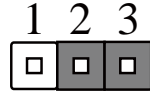

AT

2.3.3 CMOS Control Selection (JP1)

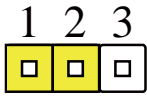

Normal (Default)

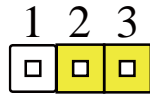

Clear CMOS

2.4 List of Connectors

The board has a number of connectors that allow you to configure your system to suit your application.

The table below shows the function of each of the board's connectors.

Label	Function
CN41	SODIMM Channel A
C40	Dual HDMI Port
CN4, CN5	RJ-45 LAN Connector
CN26	M.2 2230 E-Key Slot
CN25	M.2 2280 M-Key Slot
CN2	Full-size Mini Card Slot
CN3	SIM Slot (for Mini Card)
CN12	Debug Card Connector (eSPI Bus)
CN14	SATA Connector
CN15	SATA PWR Connector
CN39	DIO Connector
CN45	DIO Connector (Box Connector)
CN17 (COM1)	RS-232/422/485
CN18 (COM2)	RS-232/422/485
CN19	COM 1 RS-232/422/485 Box Connector
CN20	COM 2 RS-232/422/485 Box Connector
CN23	COM 3 RS-232/422/485 Box Connector
CN24	COM 4 RS-232/422/485 Box Connector
CN29 (USB3.2)	Dual USB 3.2 Connector
CN38 (USB2.0)	Dual USB 2.0 Connector
CN31	USB 2.0 Box Connector
CN32	USB 2.0 Wafer Box Connector
CN34	Audio Box Connector
CN46	Power Input Connector
SW1	Power Button w/LED
BAT1	RTC Connector

Label	Function
CN9	Reset Switch Box Connector
CN8	PS_ON Box Connector

2.4.1 Audio Box Connector (CN34)

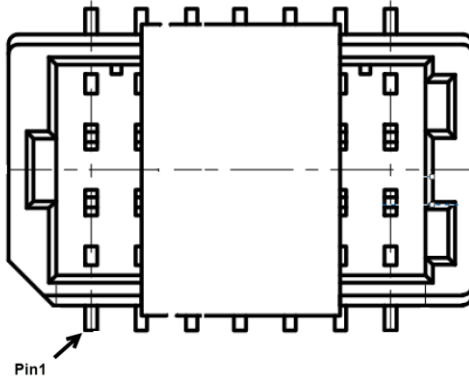

Pin	Pin Name	Signal Type
1	LINE_OUT_R	OUT
2	MIC_R	IN
3	LINE_OUT_L	OUT
4	MIC_L	IN
5	HPOUT-JD	IN
6	MIC-JD	IN
7	AUD_GND	GND
8	AUD_GND	GND
9	LINE_IN_JD	IN
10	LINE_IN_R	IN
11	+VDD_AUD	PWR
12	LINE_IN_L	IN
13	AUD_GND	GND
14	AUD_GND	GND

2.4.2 Dual HDMI Port (CN40)

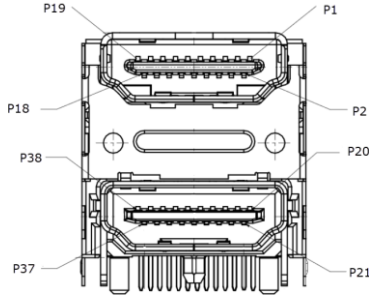

Pin	Pin Name	Signal Type
P1	HDMI1_DATA2_P	DIFF
P2	GND	GND
P3	HDMI1_DATA2_N	DIFF
P4	HDMI1_DATA1_P	DIFF
P5	GND	GND
P6	HDMI1_DATA1_N	DIFF
P7	HDMI1_DATA0_P	
P8	GND	GND
P9	HDMI1_DATA0_N	
P10	HDMI1_CLK_P	DIFF
P11	GND	GND
P12	HDMI1_CLK_N	DIFF
P13	NC	
P14	NC	
P15	HDMI1_SCL	
P16	HDMI1_SDA	
P17	GND	GND
P18	+V5S_HDMI_CON	PWR
P19	HDMI1_HPD	
P20	HDMI2_DATA2_P	
P21	GND	GND
P22	HDMI2_DATA2_N	

Pin	Pin Name	Signal Type
P23	HDMI2_DATA1_P	
P24	GND	GND
P25	HDMI2_DATA1_N	
P26	HDMI2_DATA0_P	
P27	GND	GND
P28	HDMI2_DATA0_N	
P29	HDMI2_CLK_P	
P30	GND	GND
P31	HDMI2_CLK_N	
P32	NC	
P33	NC	
P34	HDMI2_SCL	
P35	HDMI2_SDA	
P36	GND	GND
P37	+V5S_HDMI_CON	
P38	HDMI2_HPD	

2.4.3 Dual USB 3.2 Port (CN29)

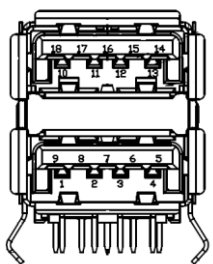

Pin	Pin Name	Signal Type
1	+5VSB	PWR
2	USB_D-	DIFF
3	USB_D+	DIFF
4	GND	GND
5	USB3_RX_N	DIFF

Pin	Pin Name	Signal Type
6	USB3_RX_P	DIFF
7	GND	GND
8	USB3_TX_N	DIFF
9	USB3_TX_P	DIFF
10	+5VSB	PWR
11	USB_D-	DIFF
12	USB_D+	DIFF
13	GND	GND
14	USB3_RX_N	DIFF
15	USB3_RX_P	DIFF
16	GND	GND
17	USB3_TX_N	DIFF
18	USB3_TX_P	DIFF

2.4.4 Dual USB 2.0 Port (CN38)

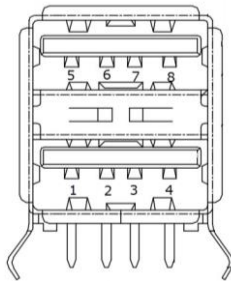

Pin	Pin Name	Signal Type
1	+5VSB	PWR
2	USB_D-	DIFF
3	USB_D+	DIFF
4	GND	GND
5	+5VSB	PWR
6	USB_D-	DIFF
7	USB_D+	DIFF
8	GND	GND

2.4.5 RJ-45 LAN (CN4/CN5)

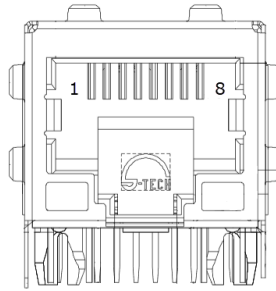

Pin	Pin Name	Signal Type
1	MDI0+	DIFF
2	MDI0-	DIFF
3	MDI1+	DIFF
4	MDI2+	DIFF
5	MDI2-	DIFF
6	MDI1-	DIFF
7	MDI3+	DIFF
8	MDI3-	DIFF

2.4.6 M.2 2280 M-Key (CN25)

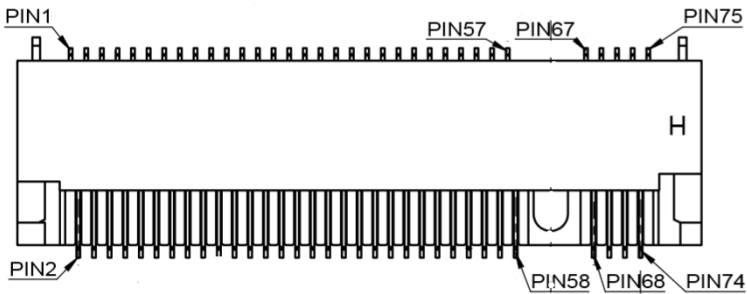

Pin	Pin Name	Signal Type	Pin	Pin Name	Signal Type
1	GND	GND	2	+3.3V	PWR
3	GND	GND	4	+3.3V	PWR

Pin	Pin Name	Signal Type	Pin	Pin Name	Signal Type
5	PCIE_RXN0	IN	6	CARD_PWR_OF F_N	OUT
7	PCIE_RXP0	IN	8	NC	
9	GND	GND	10	NC	
11	PCIE_TXN0	OUT	12	+3.3V	PWR
13	PCIE_TXP0	OUT	14	+3.3V	PWR
15	GND	PWR	16	+3.3V	PWR
17	PCIE_RXN1	IN	18	+3.3V	PWR
19	PCIE_RXP1	IN	20	NC	
21	GND	PWR	22	NC	
23	PCIE_TXN1	OUT	24	NC	
25	PCIE_TXP1	OUT	26	NC	
27	GND	PWR	28	NC	
29	PCIE_RXN2	IN	30	NC	
31	PCIE_RXP2	IN	32	NC	
33	GND	GND	34	NC	
35	PCIE_TXN2	OUT	36	NC	
37	PCIE_TXP2	OUT	38	DEVS_LP	IN
39	GND	GND	40	SMB_CLK_M2	
41	PCIE_RXP3	IN	42	SMB_DATA_M2	
43	PCIE_RXN3	IN	44	NC	
45	GND	GND	46	NC	
47	PCIE_TXN3	OUT	48	NC	
49	PCIE_TXP3	OUT	50	RESET#	IN
51	GND	PWR	52	CLKREQ#	OUT
53	PCIE_M.2_CLK#	OUT	54	WAKE#	OUT
55	PCIE_M.2_CLK	OUT	56	NC	
57	GND	GND	58	NC	
67	NC		68	NC	

Pin	Pin Name	Signal Type	Pin	Pin Name	Signal Type
69	NC		70	+3.3V	PWR
71	GND	GND	72	+3.3V	PWR
73	GND	GND	74	+3.3V	PWR
75	GND	GND			

2.4.7 Full Size Mini Card (CN2)

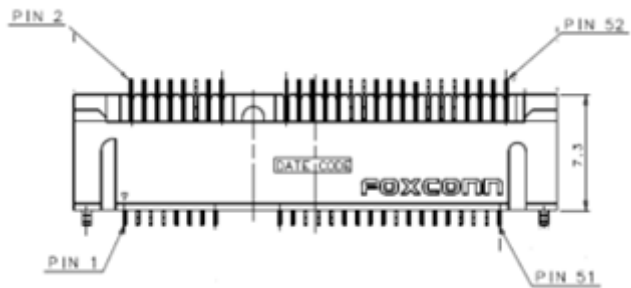

Pin	Pin Name	Signal Type
1	PCIE_WAKE#	IN
2	+3.3V	PWR
3	NC	
4	GND	GND
5	NC	
6	+1.5V	PWR
7	PCIE_CLK_REQ#	IN
8	UIM_PWR	PWR
9	GND	GND
10	UIM_DATA	I/O
11	PCIE_REF_CLK-	DIFF
12	UIM_CLK	IN
13	PCIE_REF_CLK+	DIFF
14	UIM_RESET	IN
15	GND	GND
16	UIM_VPP	PWR
17	NC	

Pin	Pin Name	Signal Type
18	GND	GND
19	NC	
20	W_DISABLE#	OUT
21	GND	GND
22	PCIE_RST#	OUT
23	PCIE_RX-	DIFF
24	+3.3VSB	PWR
25	PCIE_RX+	DIFF
26	GND	GND
27	GND	GND
28	+1.5V	PWR
29	GND	GND
30	SMB_CLK	I/O
31	PCIE_TX-	DIFF
32	SMB_DATA	I/O
33	PCIE_TX+	DIFF
34	GND	GND
35	GND	GND
36	USB_D-	DIFF
37	GND	GND
38	USB_D+	DIFF
39	+3.3VSB	PWR
40	GND	GND
41	+3.3VSB	PWR
42	NC	
43	GND	GND
44	NC	
45	MINICARD_SATA_PCIE_DET	
46	NC	
47	NC	
48	+1.5V	PWR
49	NC	
50	GND	GND

Pin	Pin Name	Signal Type
51	NC	
52	+3.3VSB	PWR

2.4.8 Debug Card Connector (CN12)

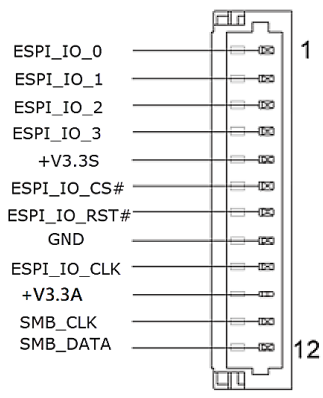

Pin	Pin Name	Signal Type
1	ESPI_IO_0	I/O
2	ESPI_IO_1	I/O
3	ESPI_IO_2	I/O
4	ESPI_IO_3	I/O
5	+3.3V	PWR
6	ESPI_IO_CS#	IN
7	ESPI_IO_RST#	IN
8	GND	GND
9	EPSI_IO_LCLK	IN
10	SMCLK	IN
11	SMDAT	I/O
12	NC	

2.4.9 SATA Connector (CN14)

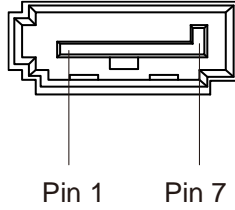

Pin	Pin Name	Signal Type
1	GND	GND
2	SATA_TX+	DIFF
3	SATA_TX-	DIFF
4	GND	GND
5	SATA_RX-	DIFF
6	SATA_RX+	DIFF
7	GND	GND

2.4.10 SATA PWR Connector (CN15)

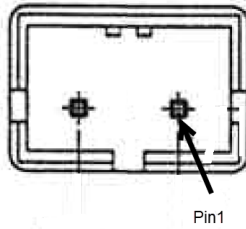

Pin	Pin Name	Signal Type
1	+5VS	PWR
2	GND	GND

2.4.11 DIO Port (CN39)

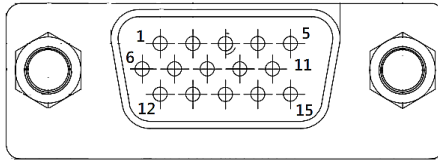

Pin	Pin Name	Signal Type	Signal Level
1	DIO0	I/O	+5V
2	DIO1	I/O	+5V
3	DIO2	I/O	+5V
4	DIO3	I/O	+5V
5	DIO4	I/O	+5V
6	DIO5	I/O	+5V
7	DIO6	I/O	+5V
8	DIO7	I/O	+5V
9	NC		
10	NC		
11	NC		
12	NC		
13	NC		

Pin	Pin Name	Signal Type	Signal Level
14	GND	GND	
15	+5V	PWR	+5V

2.4.12 DIO Box Connector (CN45)

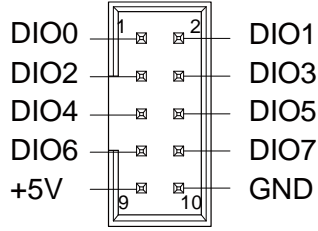

Pin	Pin Name	Signal Type	Signal Level
1	DIO0	I/O	+5V
2	DIO1	I/O	+5V
3	DIO2	I/O	+5V
4	DIO3	I/O	+5V
5	DIO4	I/O	+5V
6	DIO5	I/O	+5V
7	DIO6	I/O	+5V
8	DIO7	I/O	+5V
9	+5V	PWR	+5V
10	GND	GND	

2.4.13 COM Port 1 ~ 3 (RS-232/422/485) (CN17, CN18, CN21)

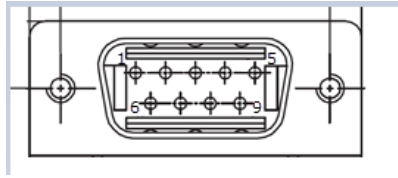

Pin	RS-232	RS-422	RS-485	Signal Type
1	DCD	RS422_TX-	RS485_D-	IN
2	RX	RS422_TX+	RS485_D+	IN
3	TX	RS422_RX+		OUT
4	DTR	RS422_RX-		OUT
5	GND			GND
6	DSR			IN
7	RTS			OUT
8	CTS			IN
9	RI			IN

2.4.14 COM 1 Box Connector (Optional) (CN19)

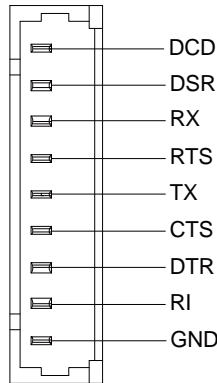

Pin	RS-232	RS-422	RS-485	Signal Type
1	DCD1	RS422_TX-	RS485_D-	IN
2	DSR1			IN
3	RX1	RS422_TX+	RS485_D+	IN

Pin	RS-232	RS-422	RS-485	Signal Type
4	RTS1			OUT
5	TX1	RS422_RX+		OUT
6	CTS1			IN
7	DTR1	RS422_RX-		OUT
8	RI1			IN
9	GND			GND

2.4.15 COM 2 Box Connector (Optional) (CN20)

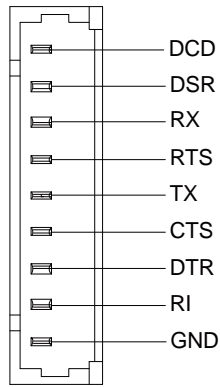

Pin	RS-232	RS-422	RS-485	Signal Type
1	DCD2	RS422_TX-	RS485_D-	IN
2	DSR2			IN
3	RX2	RS422_TX+	RS485_D+	IN
4	RTS2			OUT
5	TX2	RS422_RX+		OUT
6	CTS2			IN
7	DTR2	RS422_RX-		OUT
8	RI2			IN
9	GND			GND

2.4.16 COM 3 Box Connector (Optional) (CN23)

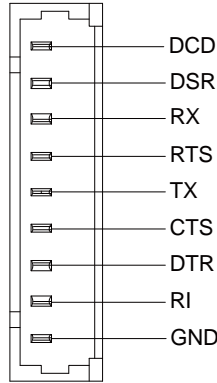

Pin	RS-232	RS-422	RS-485	Signal Type
1	DCD3	RS422_TX-	RS485_D-	IN
2	DSR3			IN
3	RX3	RS422_TX+	RS485_D+	IN
4	RTS3			OUT
5	TX3	RS422_RX+		OUT
6	CTS3			IN
7	DTR3	RS422_RX-		OUT
8	RI3			IN
9	GND			GND

2.4.17 COM 4 Box Connector (Optional) (CN24)

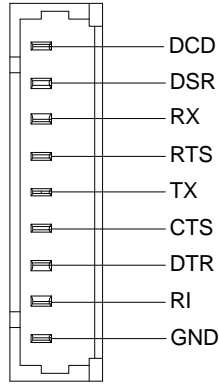

Pin	RS-232	RS-422	RS-485	Signal Type
1	DCD4	RS422_TX-	RS485_D-	IN
2	DSR4			IN
3	RX4	RS422_TX+	RS485_D+	IN
4	RTS4			OUT
5	TX4	RS422_RX+		OUT
6	CTS4			IN
7	DTR4	RS422_RX-		OUT
8	RI4			IN
9	GND			GND

2.4.18 M.2 2230 E-Key (CN26)

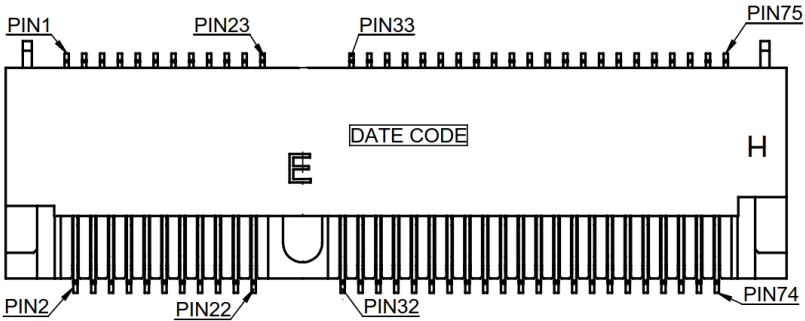

Pin	Pin Name	Signal Type	Pin	Pin Name	Signal Type
1	GND	GND	2	+3.3V	PWR
3	USB_2.0_P	DIFF	4	+3.3V	PWR
5	USB_2.0_N	DIFF	6	NC	
7	GND	GND	8	NC	
9	NC		10	NC	
11	NC		12	NC	
13	NC		14	NC	
15	NC		16	NC	
17	NC		18	GND	GND
19	NC		20	NC	
21	NC		22	NC	
23	NC				
			32	NC	
33	GND	GND	34	NC	
35	PCIE_TXP	DIFF	36	NC	
37	PCIE_TXN	DIFF	38	NC	
39	GND	GND	40	NC	
41	PCIE_RXP	DIFF	42	NC	
43	PCIE_RXN	DIFF	44	NC	
45	GND	GND	46	NC	

Pin	Pin Name	Signal Type	Pin	Pin Name	Signal Type
47	PCIE_CLK	DIFF	48	NC	
49	PCIE_CLK#	DIFF	50	SUSCLK	
51	GND		52	PLT_RESET#	
53	PCIE_CLKREQ#		54	BT_DIS#	
55	PCIE_WAKE#		56	WLAK_DIS#	
57	GND	GND	58	NC	
59	NC		60	NC	
61	NC		62	NC	
63	GND	GND	64	NC	
65	NC		66	NC	
67	NC		68	NC	
69	GND	GND	70	+3.3V	PWR
71	NC		72	+3.3V	PWR
73	NC		74	+3.3V	PWR
75	GND	GND			

2.4.19 USB 2.0 Wafer Box Connector (CN31/CN32)

Pin	Pin Name	Signal Type
1	+5V	GND
2	USB D-	DIFF
3	USB D+	DIFF
4	GND	GND
5	GND	GND

2.5 Hardware Assembly

This section details the hardware assembly steps for the BOXER-6406-ADN. Please read this section thoroughly before beginning installation and ensure you have all necessary peripheral hardware ready.

2.5.1 2.5" SATA Drive Installation

Before installing the SATA Drive, ensure the system is powered down and disconnect the power cord from the system. Make sure you have the SATA Drive ready to install.

Step 1: Remove the eight (8) screws from the bottom of the chassis to remove the bottom panel from the system. Then attach the SATA drive to the HDD Bracket using the four (4) screws provided.

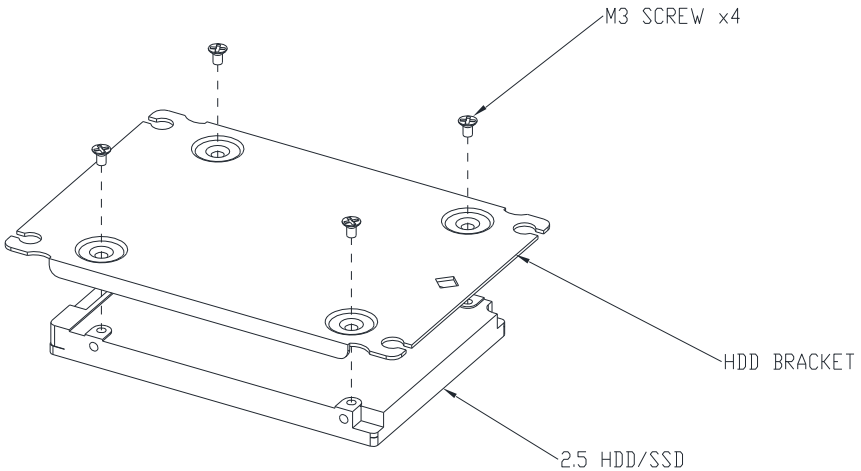

Step 2: Attach the assembled HDD to the HDD Base Bracket using four screws as shown in the figure below. Please use the rubber washers provided when affixing HDD to bracket. Attach the SATA and SATA Power cables to the board and the SATA drive.

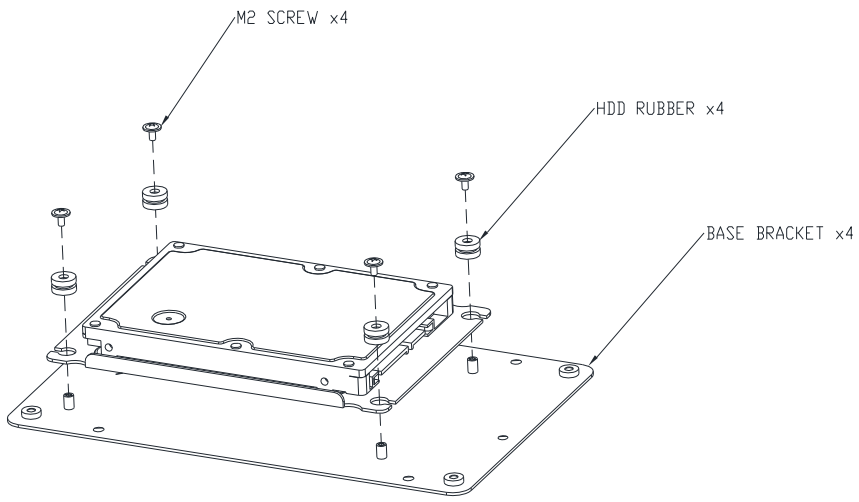

2.5.2 M.2 Module Installation

The M.2 2230 E-Key, M.2 2280 M-Key, and Mini Card slots are accessible by removing the bottom panel.

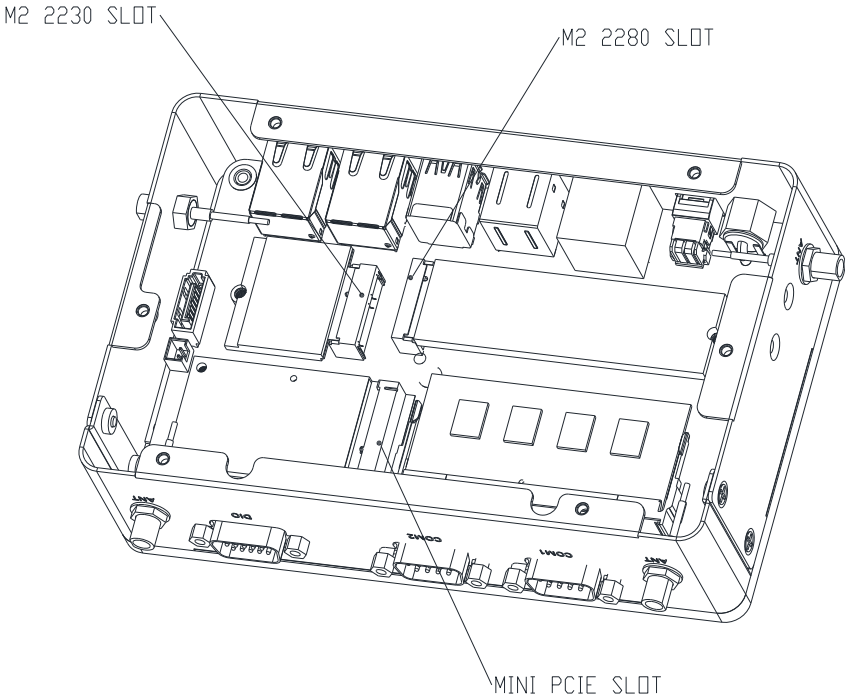

Follow standard procedures for expansion card installation, aligning the notch on each M.2 SSD with its respective key slot.

2.5.3 DIMM Heatsink Installation

Note: As the BOXER-6406U-ADN supports both single and double-sided DDR5 modules, please ensure to follow the below guidance on thermal pad thickness.

DDR5 Type	Thermal Pad
Single	2.0mm
Double	1.0mm

Follow the below diagram to install DIMM heatsink, ensuring a DIMM thermal pad is placed between the DIMM heatsink and DIMM module.

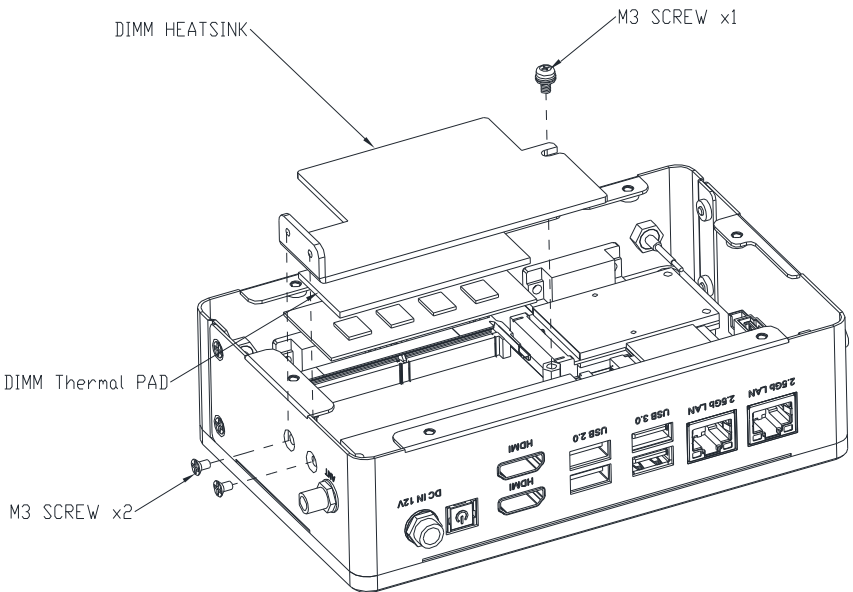

2.5.4 Wall Mount Installation

For wall mount assembly, affix the two (2) wall mount brackets to the bottom side of the chassis using the four (4) screws provided.

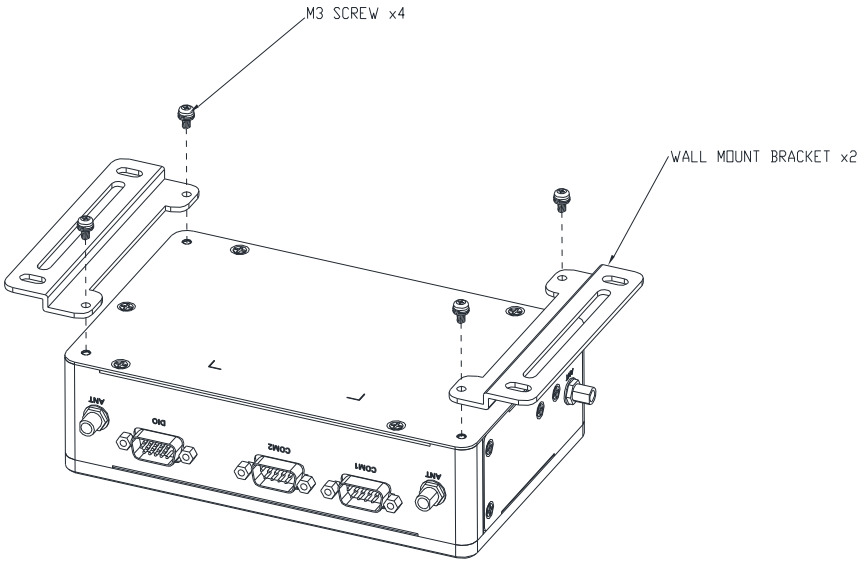

Chapter 3

AMI BIOS Setup

3.1 System Test and Initialization

The system uses certain routines to perform testing and initialization. If an error, fatal or non-fatal, is encountered, a few short beeps or an error message will be outputted. The board can usually continue the boot up sequence with non-fatal errors.

The system configuration verification routines check the current system configuration against the values stored in the CMOS memory. If they do not match, an error message will be outputted, in which case you will need to run the BIOS setup program to set the configuration information in memory.

There are three situations in which you will need to change the CMOS settings:

- You are starting your system for the first time
- You have changed your system's hardware
- The CMOS memory has lost power and the configuration information is erased

The system's CMOS memory uses a backup battery for data retention, which is to be replaced once emptied.

3.2 AMI BIOS Setup

The AMI BIOS ROM has a pre-installed Setup program that allows users to modify basic system configurations, which is stored in the battery-backed CMOS RAM and BIOS NVRAM so that the information is retained when the power is turned off.

To enter BIOS Setup, press or <F2> immediately while your computer is powering up.

The function for each interface can be found below.

Main – Date and time can be set here. Press <Tab> to switch between date elements

Advanced – Enable/Disable boot option for legacy network devices

System I/O – Enable/Disable system I/O device

Security – The setup administrator password can be set here

Boot – Enable/Disable quiet Boot Option

Save & Exit – Save your changes and exit the program

3.3 Setup Submenu: Main



3.4 Setup Submenu: Advanced

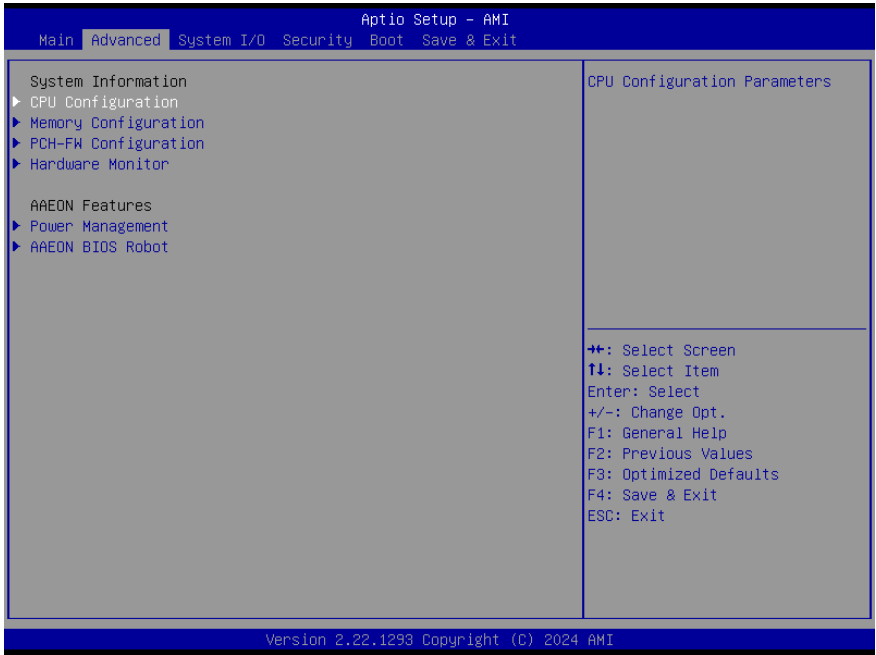

3.4.1 CPU Configuration

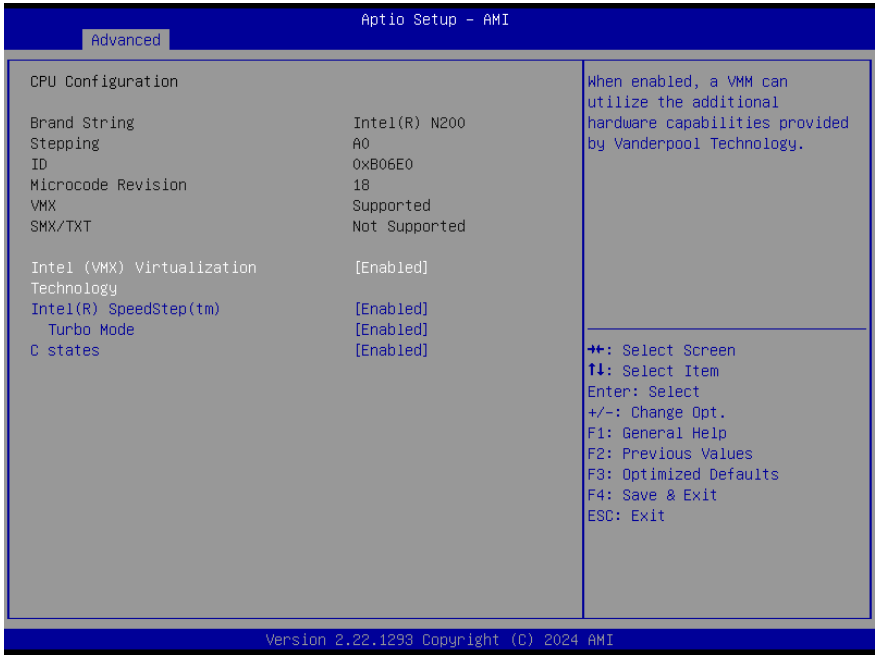

Options Summary		
Intel (VMX)Virtualization Technology	Disabled	
	Enabled	Optimal Default, Failsafe Default
When enabled, a VMM can utilize the additional hardware capabilities provided by Vanderpool Technology.		
Intel(R) SpeedStep(tm)	Disabled	
	Enabled	Optimal Default, Failsafe Default
Allows more than two frequency ranges to be supported.		
Turbo Mode	Disabled	
	Enabled	Optimal Default, Failsafe Default
Enabled/Disable processor Turbo Mode (requires EMTTM enabled too). AUTO means enabled.		
C states	Disabled	
	Enabled	Optimal Default, Failsafe Default
Enabled/Disable CPU Power Management. Allows CPU to go to C states when it's not 100% utilized		

3.4.2 Memory Configuration

Aptio Setup - AMI

Advanced

Memory Configuration

Memory RC Version	0.0.4.33
Total Memory	8192 MB
Memory Frequency	4800 MHz
tCL-tRCD-tRP-tRAS	40-39-39-77
MC 0 Ch 0 DIMM 0	Populated & Enabled
Size	8192 MB (DDR5)

++: Select Screen
↑↓: Select Item
Enter: Select
+/-: Change Opt.
F1: General Help
F2: Previous Values
F3: Optimized Defaults
F4: Save & Exit
ESC: Exit

Version 2.22.1286 Copyright (C) 2023 AMI

3.4.3 PCH-FW Configuration

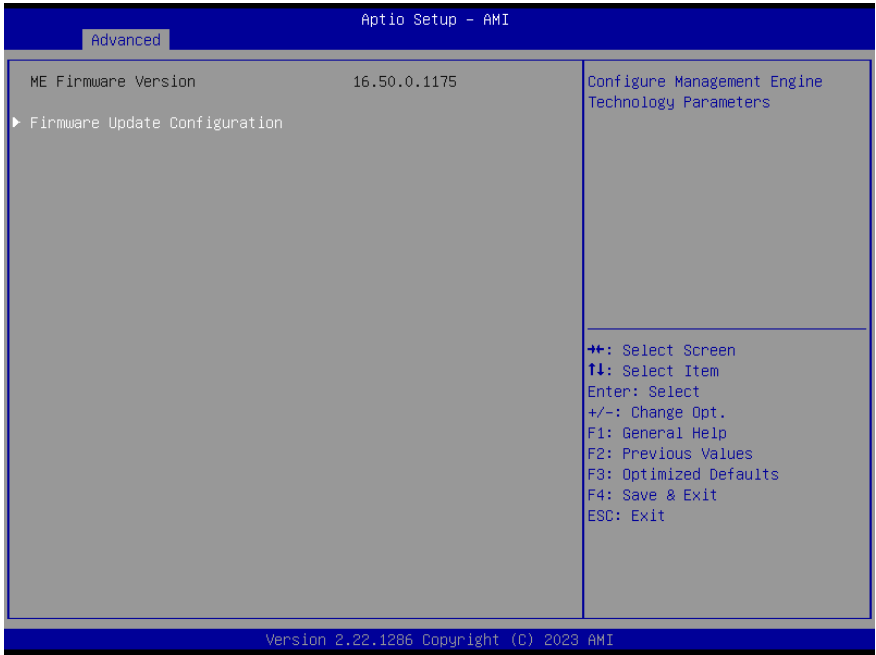

3.4.3.1 Firmware Update Configuration

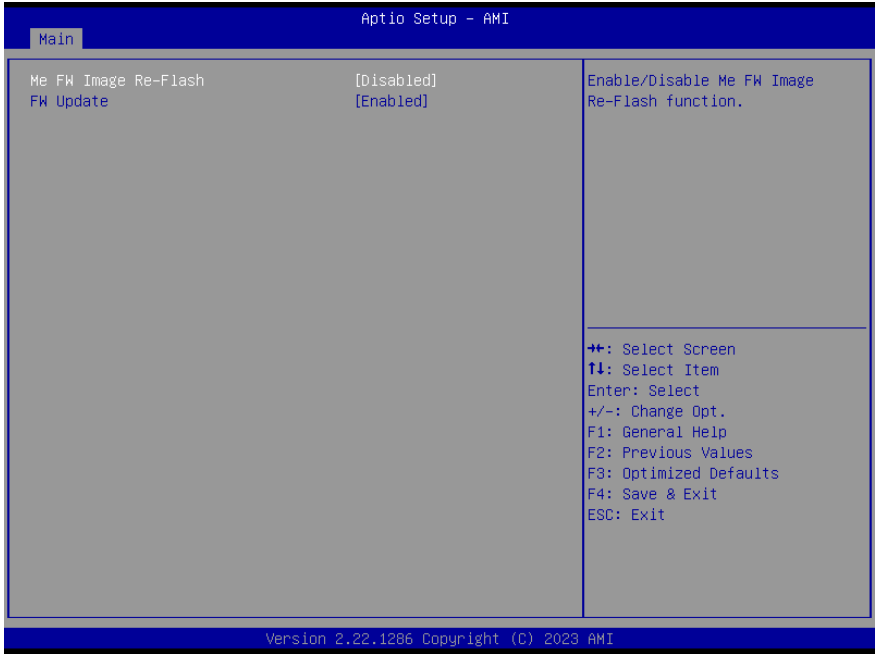

Options Summary		
Me FW Image Re-Flash	Enabled	
	Disabled	Optimal Default, Failsafe Default
Enable/Disable Me FW Image Re-Flash function.		
FW Update	Enabled	
	Disabled	Optimal Default, Failsafe Default
Enable/Disable Me FW Update function.		

3.4.4 Hardware Monitor

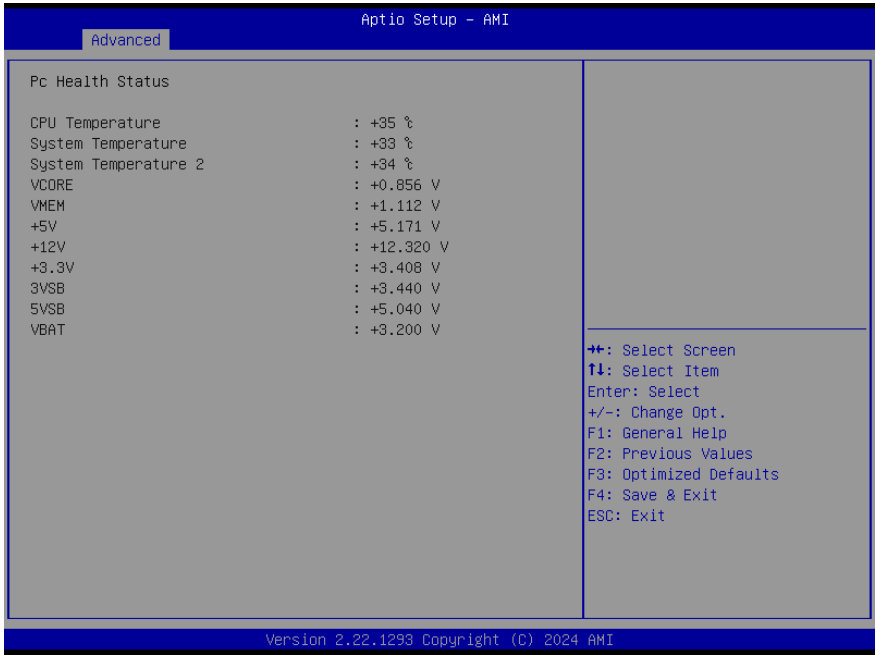

3.4.5 Power Management

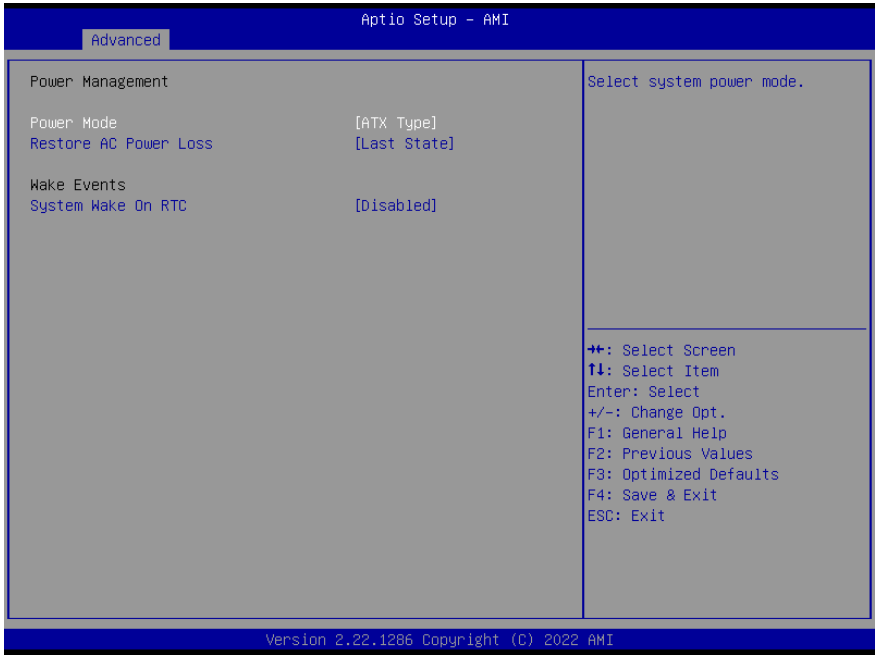

Options Summary		
Power Mode	ATX Type	Optimal Default, Failsafe Default
	AT Type	
Select system power mode.		
Restore AC Power Loss	Last State	Optimal Default, Failsafe Default
	Always On	
	Always Off	
System Wake On RTC	Disabled	Optimal Default, Failsafe Default
	By Date	
	By Weekday	
	Bypass	
By Date: System will wake on the day with hr::min::sec specified. By Weekday: System will wake on the enabled weekday with hr::min::sec specified. Bypass: BIOS will not control RTC wake function.		

3.4.6 AAEON BIOS Robot

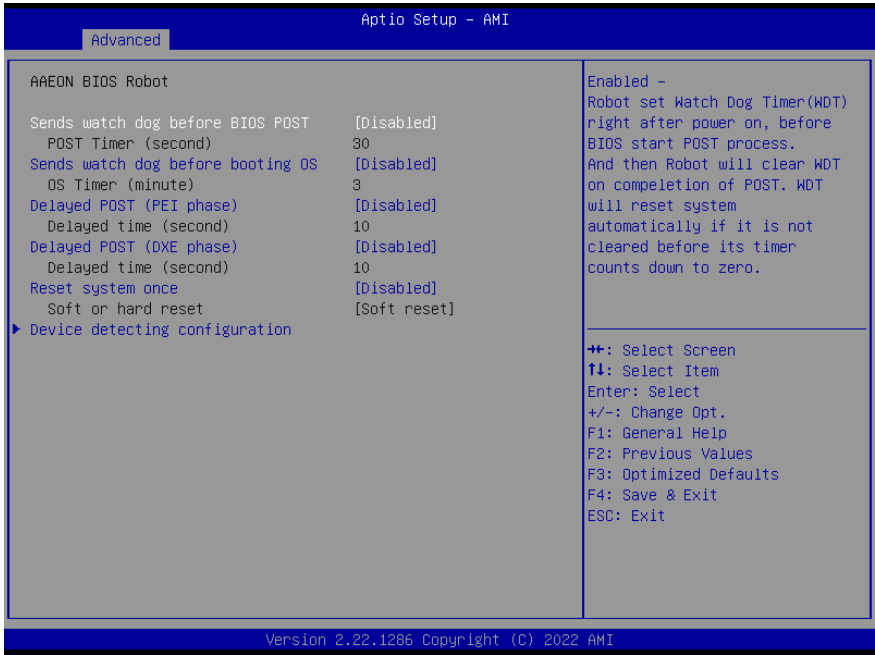

Options Summary		
Sends watch dog before BIOS POST	Disabled	Optimal Default, Failsafe Default
	Enabled	
Enabled – Robot set Watch Dog Timer (WDT) right after power on, before BIOS start POST process. And then Robot will clear WDT on completion of POST. WDT on completion of POST. WDT will reset system automatically if it is not cleared before its timer counts down to zero.		
Sends watch dog before booting OS	Disabled	Optimal Default, Failsafe Default
	Enabled	
Enabled – Robot set Watch Dog Timer (WDT) after POST completion, before BIOS transfer control to OS. WARNING: Before enabling this function, a program in OS must be in responsible for clearing WDT. Also, this function should be disabled if OS is going to update itself.		
Delayed POST (PEI phase)	Disabled	Optimal Default, Failsafe Default
	Enabled	
Enabled -Robot holds BIOS from starting POST, right after power on. This allows BIOS POST to start with stable power or start after system is physically warmed-up. Note: Robot does this before 'Sends watch dog'.		

Options Summary

Delayed POST (DXE phase)	Disabled	Optimal Default, Failsafe Default
	Enabled	

Enabled -Robot holds BIOS before POST completion. This allows BIOS POST to start with stable power or start after system is physically warmed-up.

Note: Robot does this after 'Sends watch dog before BIOS POST'.

3.4.6.1 Device Detecting Configuration



Options Summary

Action	Reset System	Optimal Default, Failsafe Default
	Hold System	

Select action that robot should do.

Soft or hard reset	Soft	Optimal Default, Failsafe Default
	Hard	

Select reset type robot should send on each boot.

Retry-Count	3	Optimal Default, Failsafe Default
-------------	---	-----------------------------------

Fill retry counter here. Robot will reset system at most counter times, and then let system continue its POST.

Options Summary

At time	After show logo	Optimal Default, Failsafe Default
	Before show logo	

Select robot action time: After show logo - Robot will do action after logo is displayed. System devices are almost ready. Before show logo - Robot will do action earlier before logo, but some devices may not be ready.

3.4.6.1.1 Device #1 Detecting Configuration

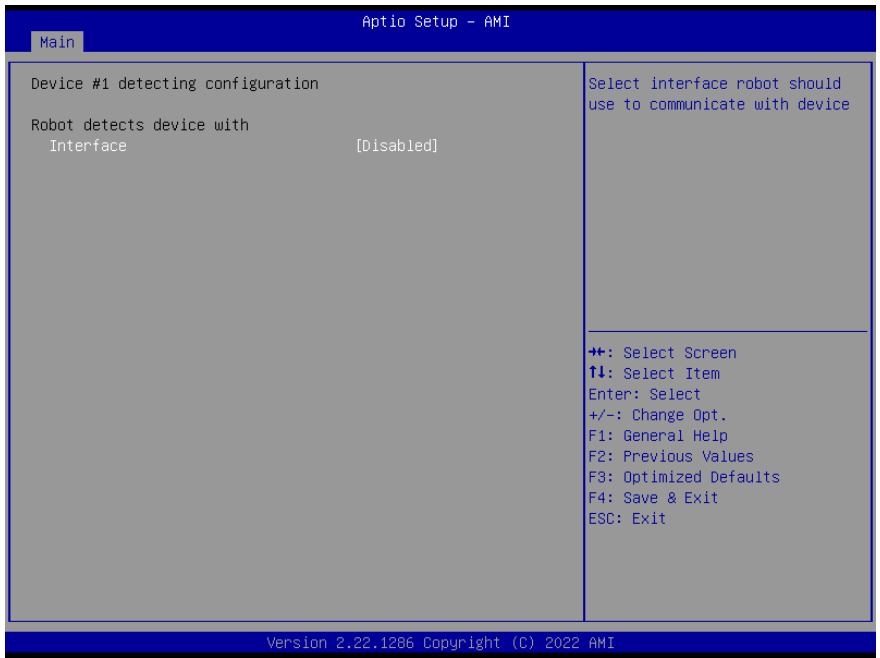

Options Summary

Interface	Disabled	Optimal Default, Failsafe Default
	PCI	
	DIO	
	SMBUS	
	Legacy I/O	
	Super I/O	
	MMIO	

Select interface robot should use to communicate with device.

3.4.6.1.2 Device #2 Detecting Configuration

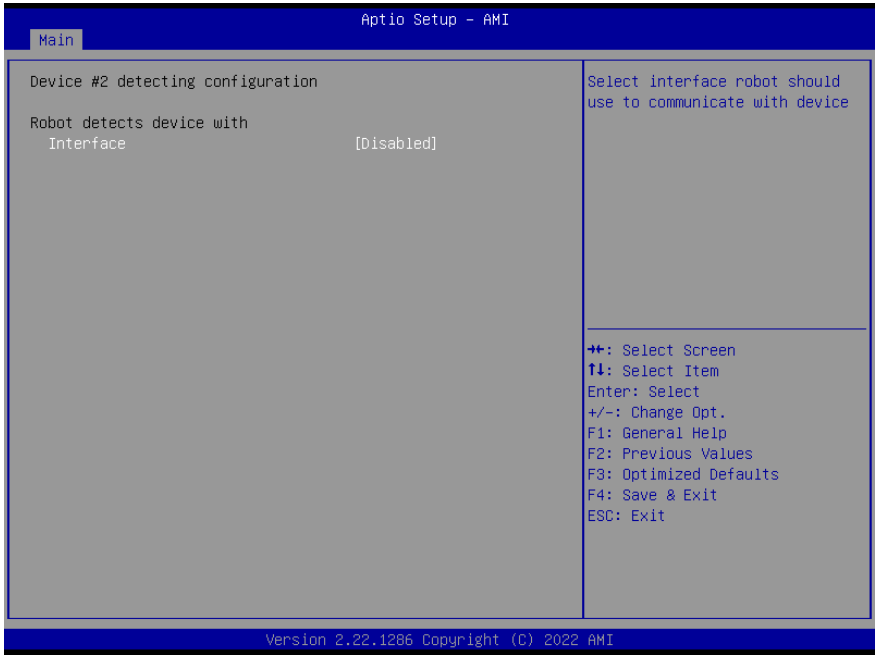

Options Summary		
Interface	Disabled	Optimal Default, Failsafe Default
	PCI	
	DIO	
	SMBUS	
	Legacy I/O	
	Super I/O	
	MMIO	
Select interface robot should use to communicate with device.		

3.4.6.1.3 Device #3 Detecting Configuration

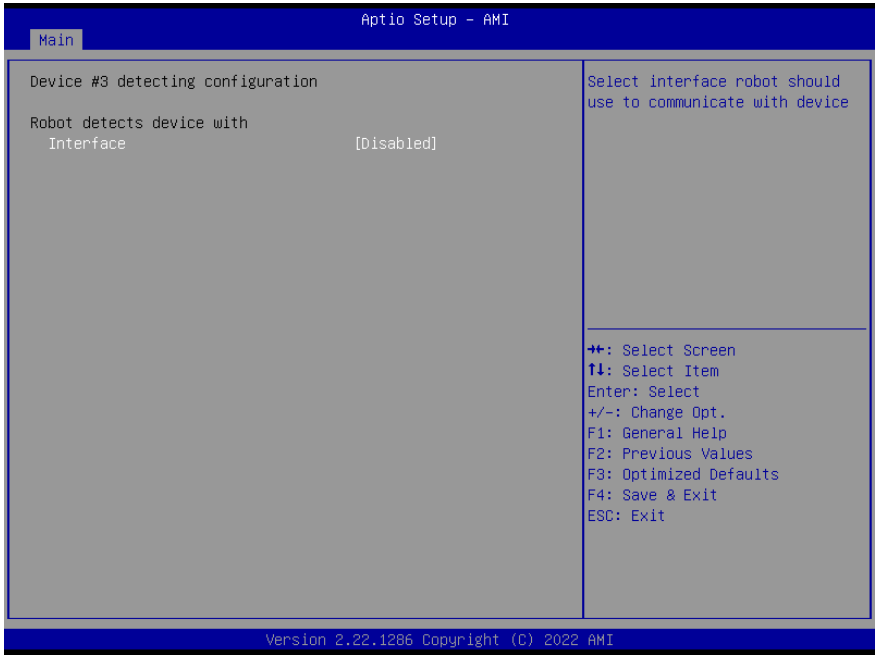

Options Summary		
Interface	Disabled	Optimal Default, Failsafe Default
	PCI	
	DIO	
	SMBUS	
	Legacy I/O	
	Super I/O	
	MMIO	
Select interface robot should use to communicate with device.		

3.4.6.1.4 Device #4 Detecting Configuration

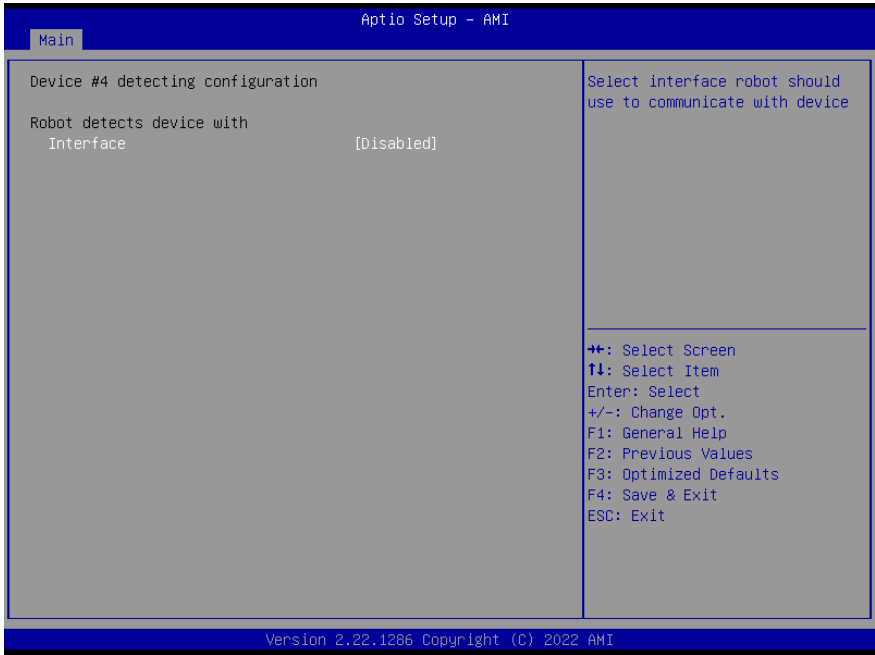

Options Summary		
Interface	Disabled	Optimal Default, Failsafe Default
	PCI	
	DIO	
	SMBUS	
	Legacy I/O	
	Super I/O	
	MMIO	
Select interface robot should use to communicate with device.		

3.4.6.1.5 Device #5 Detecting Configuration

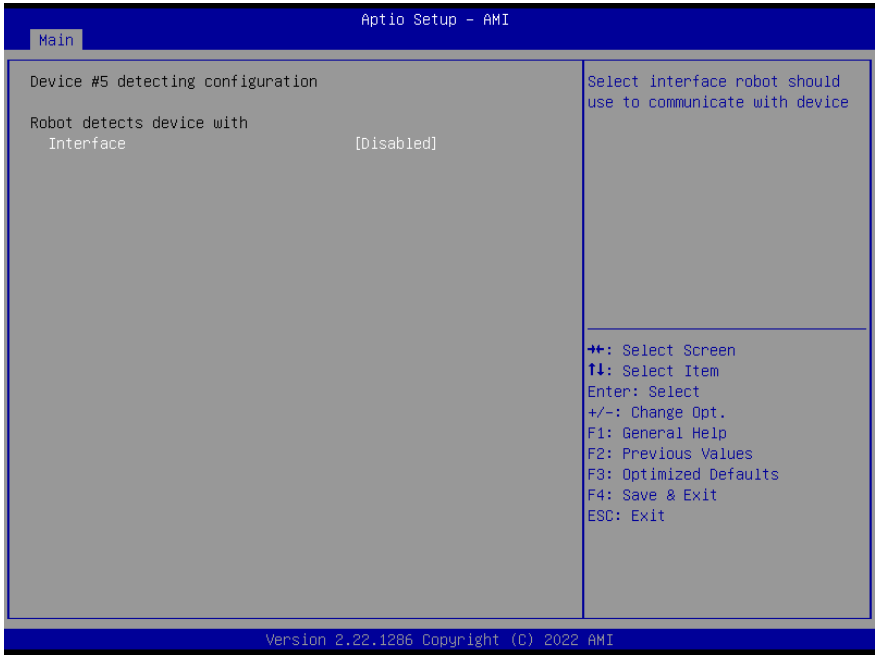

Options Summary		
Interface	Disabled	Optimal Default, Failsafe Default
	PCI	
	DIO	
	SMBUS	
	Legacy I/O	
	Super I/O	
	MMIO	
Select interface robot should use to communicate with device.		

3.5 Setup Submenu: System I/O



3.5.1 Storage Configuration

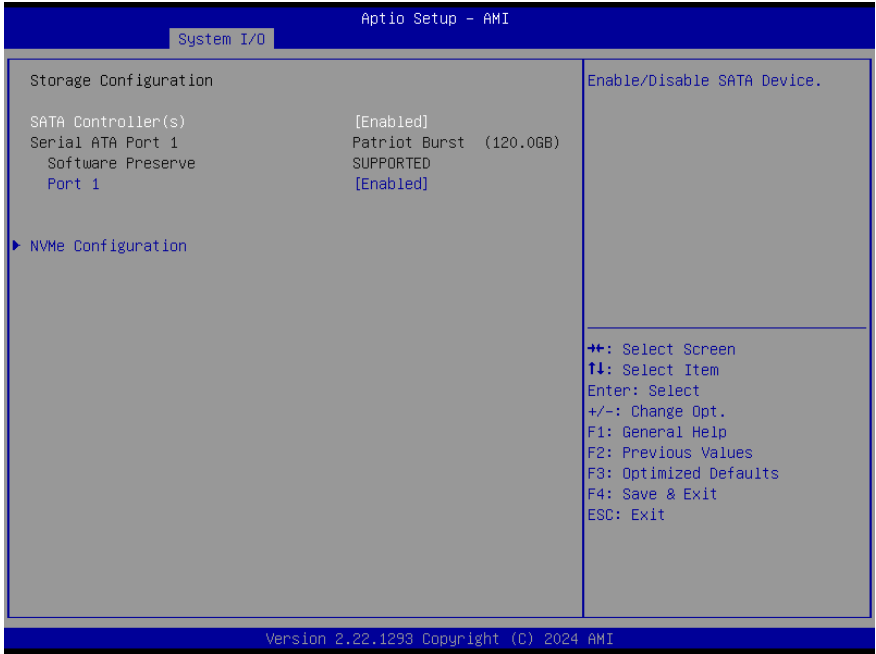

Options Summary		
SATA Controller(s)	Enabled	Optimal Default, Failsafe Default
	Disabled	
Enable/Disable to SATA Device.		
Port 1	Enabled	Optimal Default, Failsafe Default
	Disabled	
Enable/Disable to SATA Port.		

3.5.2 HD Audio Configuration

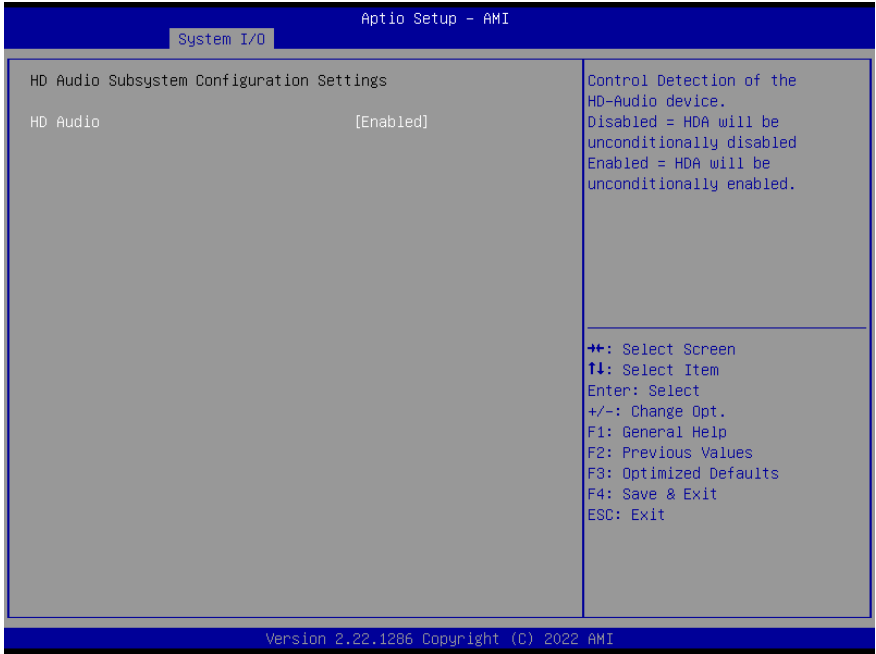

Options Summary		
HD Audio	Disabled	
	Enabled	Optimal Default, Failsafe Default
Control Detection of the HD-Audio device. Disabled = HDA will be unconditionally disabled. Enabled = HDA will be unconditionally enabled.		

3.5.3 Digital IO Port Configuration

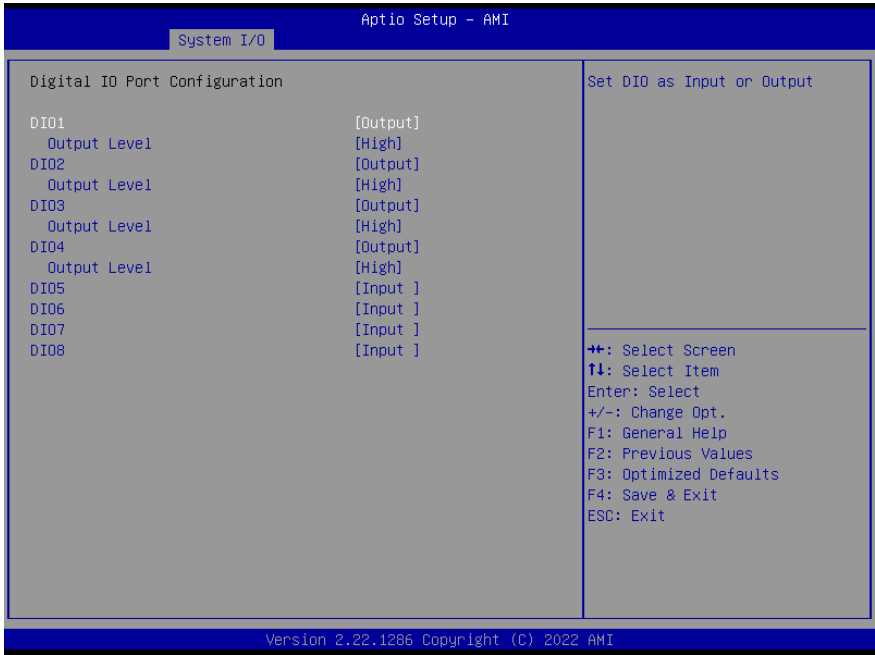

Options Summary		
DIO1	Input	
	Output	Optimal Default, Failsafe Default
Set DIO as Input or Output		
Output Level	Low	
	High	Optimal Default, Failsafe Default
Set output level when DIO pin is output		
DIO2	Input	Optimal Default, Failsafe Default
	Output	Optimal Default, Failsafe Default
Set DIO as Input or Output		
Output Level	Low	
	High	Optimal Default, Failsafe Default
Set output level when DIO pin is output		
DIO3	Input	
	Output	Optimal Default, Failsafe Default
Set DIO as Input or Output		
Output Level	Low	
	High	Optimal Default, Failsafe Default
Set output level when DIO pin is output		

Options Summary		
DIO4	Input	Optimal Default, Failsafe Default
	Output	Optimal Default, Failsafe Default
Set DIO as Input or Output		
Output Level	Low	
	High	Optimal Default, Failsafe Default
Set output level when DIO pin is output		
DIO5	Input	Optimal Default, Failsafe Default
	Output	
Set DIO as Input or Output		
DIO6	Input	Optimal Default, Failsafe Default
	Output	
Set DIO as Input or Output		
DIO7	Input	Optimal Default, Failsafe Default
	Output	
Set DIO as Input or Output		
DIO8	Input	Optimal Default, Failsafe Default
	Output	
Set DIO as Input or Output		

3.5.4 Legacy Logical Devices Configuration

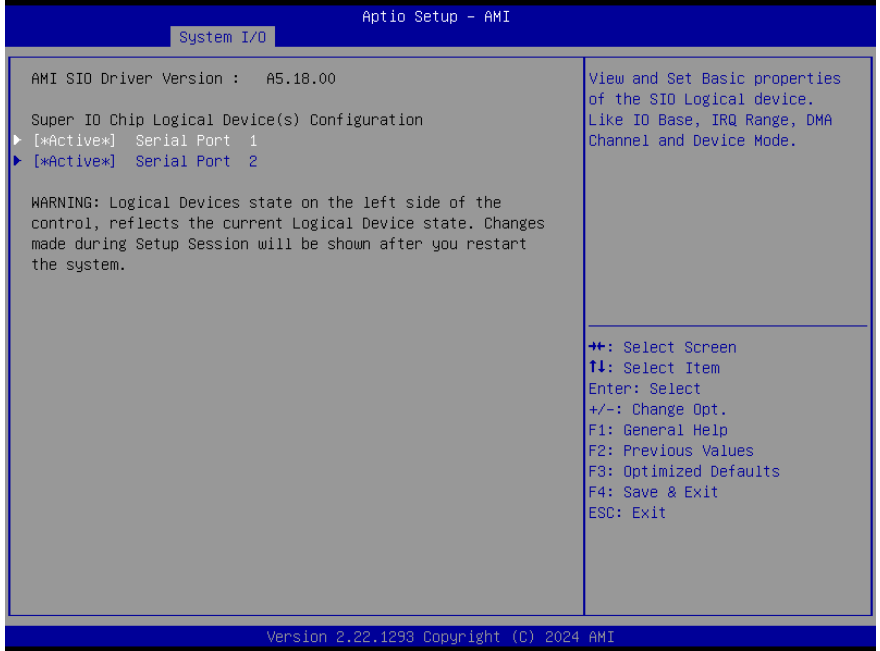

3.5.4.1 Serial Port 1

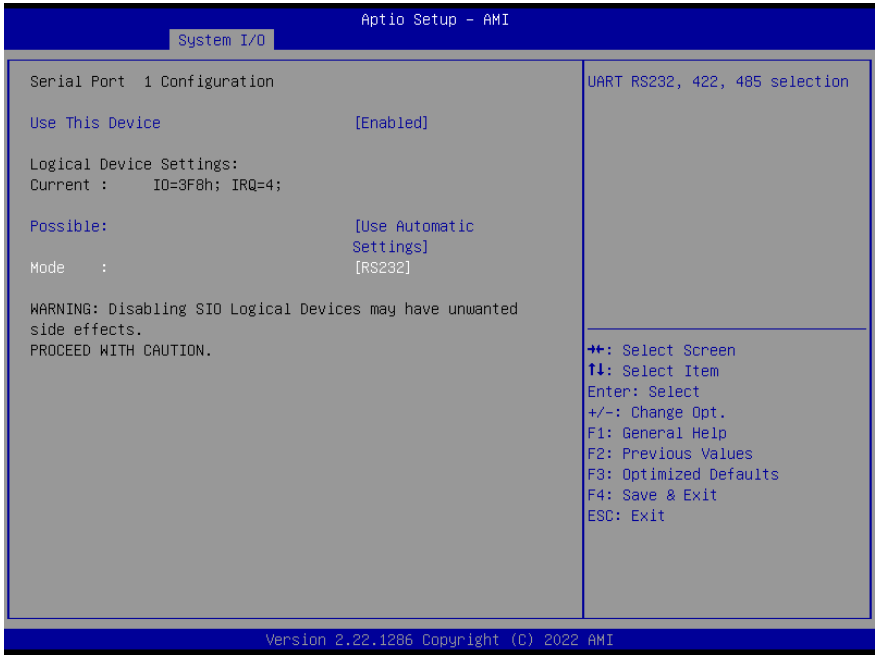

Options Summary		
Use This Device	Disabled	
	Enabled	Optimal Default, Failsafe Default
Enable or Disable this Logical Device.		
Possible:	Use Automatic Settings	Optimal Default, Failsafe Default
	IO=3F8; IRQ=4;	
	IO=2F8; IRQ=3;	
Allows the user to change the device resource settings. New settings will be reflected on this setup page after system restarts.		
Mode	RS232	Optimal Default, Failsafe Default
	RS422	
	RS485	
UART RS232, 422, 485, selection.		

3.5.4.2 Serial Port 2

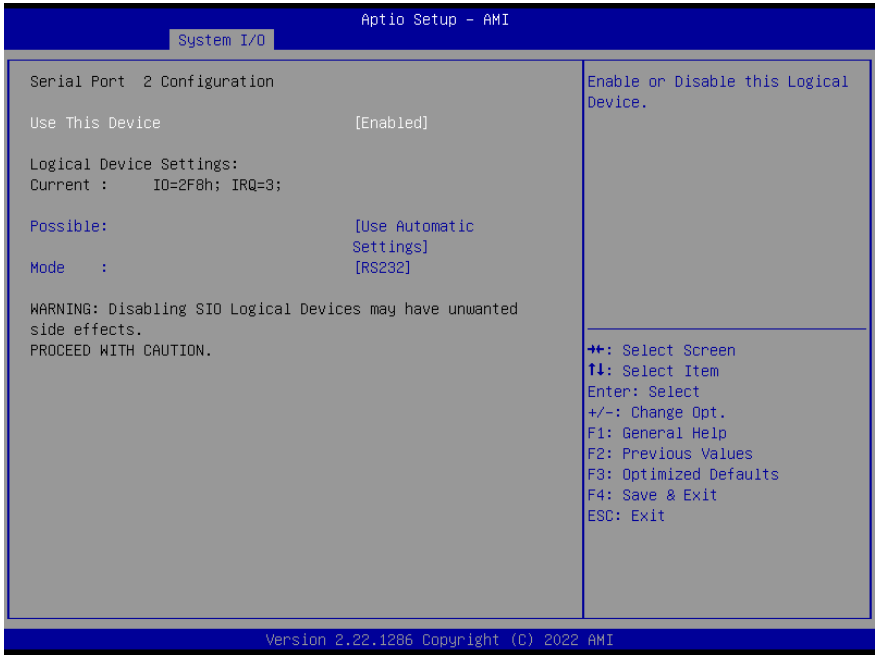

Options Summary		
Use This Device	Disabled	
	Enabled	Optimal Default, Failsafe Default
Enable or Disable this Logical Device.		
Possible:	Use Automatic Settings	Optimal Default, Failsafe Default
	IO=2F8; IRQ=3;	
	IO=3F8; IRQ=4;	
Allows the user to change the device resource settings. New settings will be reflected on this setup page after system restarts.		
Mode	RS232	Optimal Default, Failsafe Default
	RS422	
	RS485	
UART RS232, 422, 485, selection.		

3.5.5 Serial Port Console Redirection

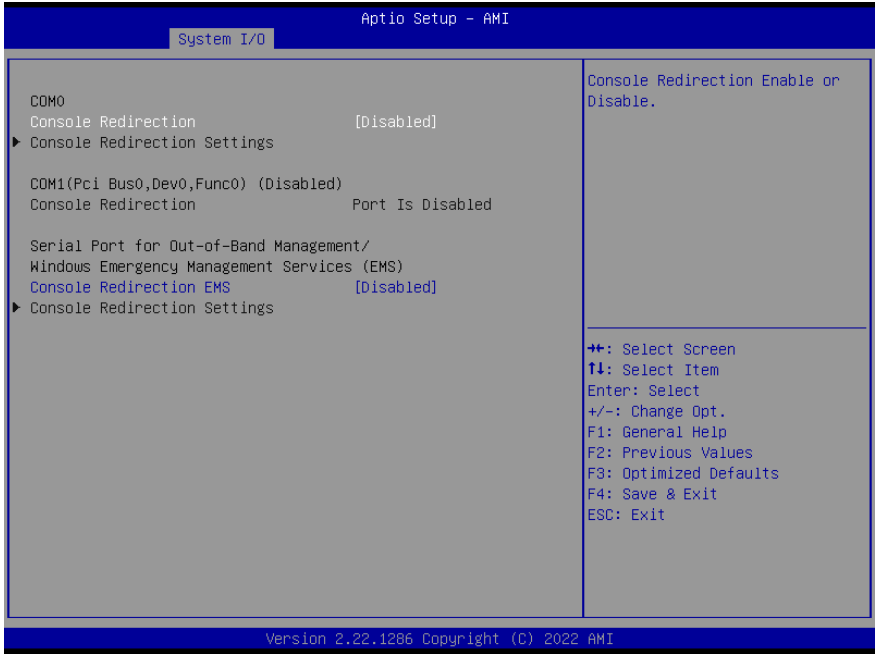

Options Summary		
Console Redirection	Disabled	Optimal Default, Failsafe Default
	Enabled	
Console Redirection Enable or Disable.		
Console Redirection EMS	Disabled	Optimal Default, Failsafe Default
	Enabled	
Console Redirection Enable or Disable.		

3.5.5.1 Console Redirection Settings (COM0)

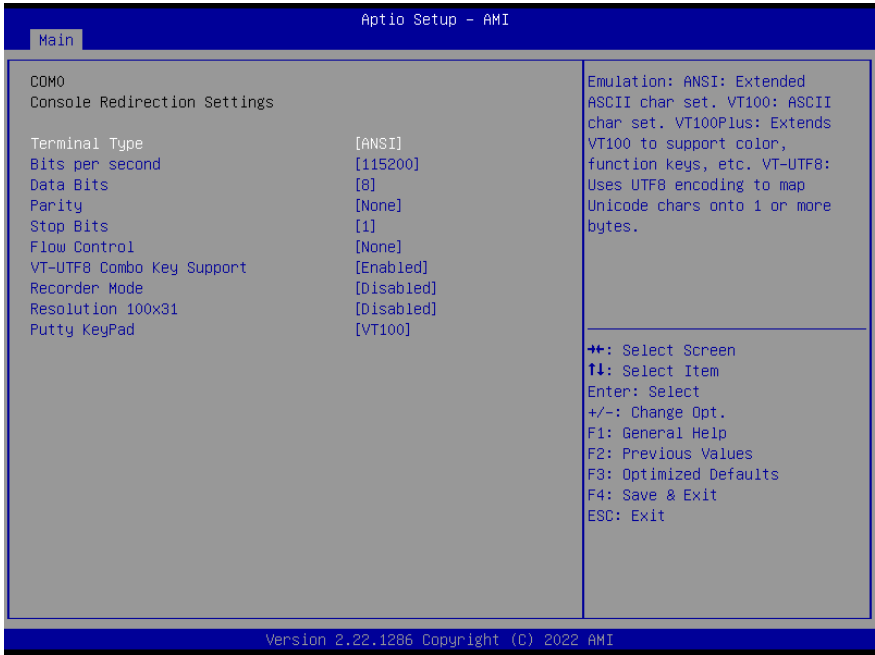

Options Summary		
Terminal Type	VT100	
	VT100Plus	
	VT-UTF8	
	ANSI	Optimal Default, Failsafe Default
Emulation: ANSI: Extended ASCII char set. VT100: ASCII char set. VT100Plus: Extends VT100 to support color, function keys, etc. VT-UTF8: Uses UTF8 encoding to map Unicode chars onto 1 or more bytes.		
Bits per second	9600	
	19200	
	38400	
	57600	
	115200	Optimal Default, Failsafe Default
Selects serial port transmission speed. The speed must be matched on the other side. Long or noisy lines may require lower speeds.		
Data Bits	7	
	8	Optimal Default, Failsafe Default
Data Bits		

Options Summary		
Parity	None	Optimal Default, Failsafe Default
	Even	
	Odd	
	Mark	
	Space	
<p>A parity bit can be sent with the data bits to detect some transmission errors. Even: parity bit is 0 if the num of 1's in the data bits is even. Odd: parity bit is 0 if num of 1's in the data bits is odd. Mark: parity bit is always 1. Space: Parity bit is always 0. Mark and Space Parity do not allow for error detection. They can be used as an additional data bit.</p>		
Stop Bits	1	Optimal Default, Failsafe Default
	2	
<p>Stop bits indicate the end of a serial data packet. (A start bit indicates the beginning). The standard setting is 1 stop bit. Communication with slow devices may require more than 1 stop bit.</p>		
Flow Control	None	Optimal Default, Failsafe Default
	Hardware RTS/CTS	
<p>Flow control can prevent data loss from buffer overflow. When sending data, if the receiving buffers are full, a 'stop' signal can be sent to stop the data flow. Once the buffers are empty, a 'start' signal can be sent to re-start the flow. Hardware flow control uses two wires to send start/stop signals.</p>		
VT-UTF8 Combo Key Support	Disabled	
	Enabled	Optimal Default, Failsafe Default
<p>Enable VT-UTF8 Combination Key Support for ANSI/VT100 terminals</p>		
Recorder Mode	Disabled	Optimal Default, Failsafe Default
	Enabled	
<p>With this mode enabled only text will be sent. This is to capture Terminal data.</p>		
Resolution 100x31	Disabled	Optimal Default, Failsafe Default
	Enabled	
<p>Enables or disables extended terminal resolution</p>		
Putty KeyPad	VT100	Optimal Default, Failsafe Default
	LINUX	
	XTERMR6	
	SCO	
	ESCN	
	VT400	
<p>Select FunctionKey and KeyPad on Putty.</p>		

3.5.5.2 Console Redirection Settings (Out-of-Band Mgmt Port)

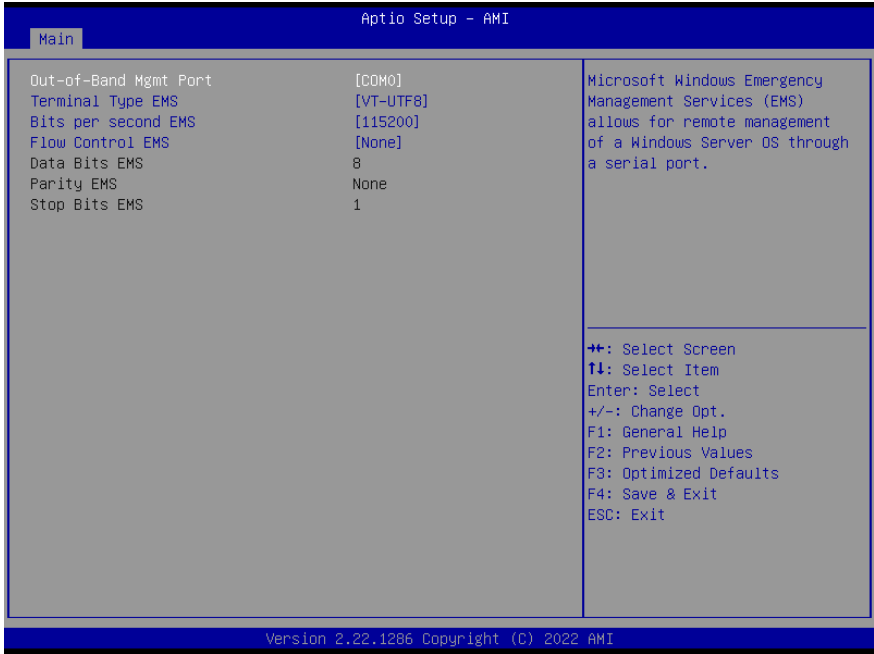

Options Summary		
Out-of-Band Mgmt Port	COM0	Optimal Default, Failsafe Default
	COM1(Pci Bus0, Dev0, Func0) (Disabled)	
Microsoft Windows Emergency Management Services (EMS) allows for remote management of a Windows Server OS through a serial port.		
Terminal Type EMS	VT100	
	VT100Plus	
	VT-UTF8	Optimal Default, Failsafe Default
	ANSI	
VT-UTF8 is the preferred terminal type for out-of-band management. The next best choice is VT100+ and then VT100. See above, in Console Redirection Settings page, for more Help with Terminal Type/Emulation.		
Bits per second EMS	9600	
	19200	
	57600	
	115200	Optimal Default, Failsafe Default
Selects serial port transmission speed. The speed must be matched on the other side. Long or noisy lines may require lower speeds.		

Options Summary		
Flow Control EMS	None	Optimal Default, Failsafe Default
	Hardware RTS/CTS	
	Software Xon/Xoff	
<p>Flow control can prevent data loss from buffer overflow. When sending data, if the receiving buffers are full, a 'stop' signal can be sent to stop the data flow. Once the buffers are empty, a 'start' signal can be sent to re-start the flow. Hardware flow control uses two wires to send start/stop signals.</p>		

3.6 Setup Submenu: Security

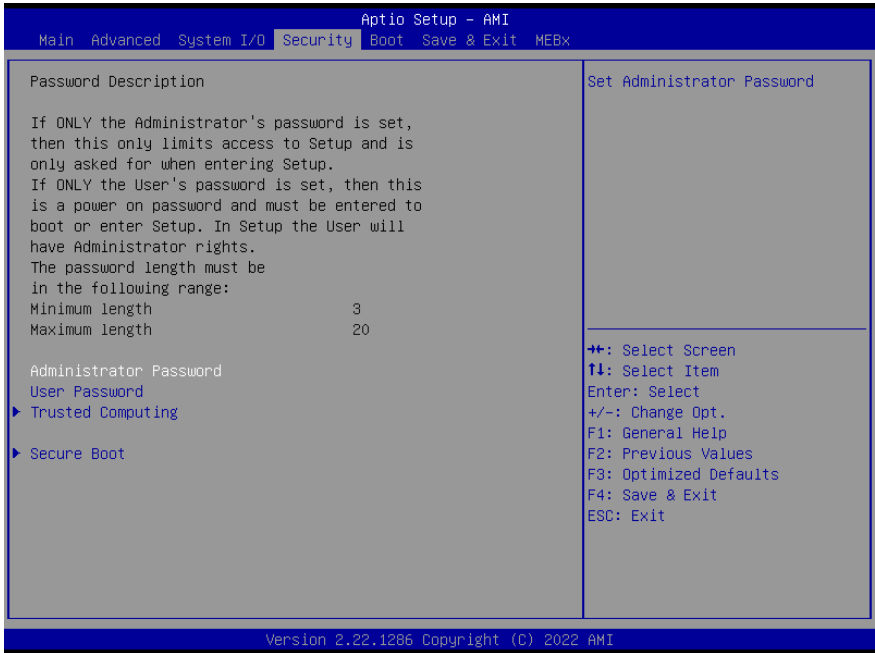

Change User/Administrator Password

You can set a User Password once an Administrator Password. The password will be required during boot up, or when the user enters the Setup utility. Please Note that a User Password does not provide access to many of the features in the Setup utility.

Select the password you wish to set, press Enter to open a dialog box to enter your password (you can enter no more than six letters or numbers). Press Enter to confirm your entry, after which you will be prompted to retype your password for a final confirmation. Press Enter again after you have retyped it correctly.

Removing the Password

Highlight this item and type in the current password. At the next dialog box press Enter to disable password protection.

3.6.1 Trusted Computing

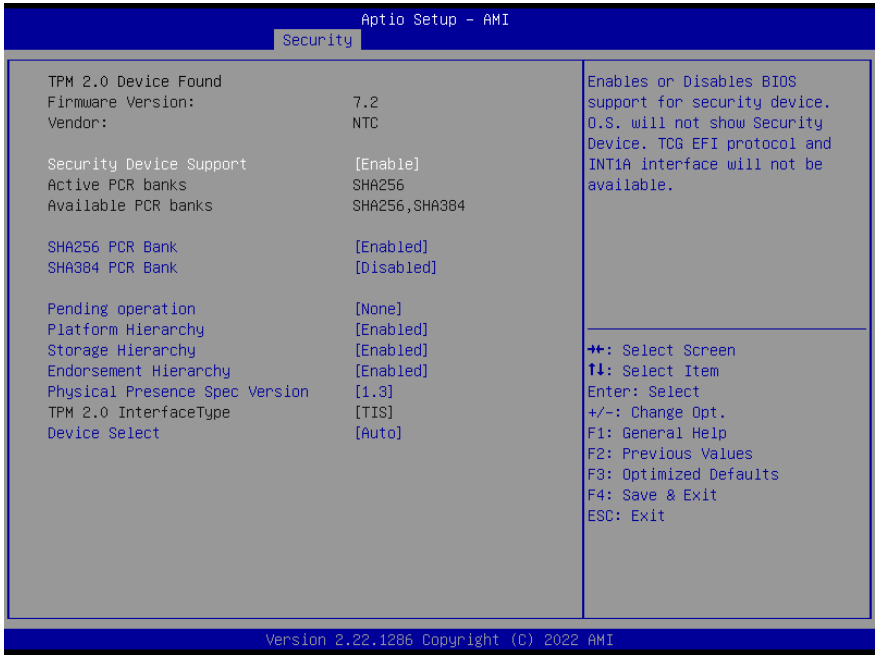

Options Summary		
Security Device Support	Enable	Optimal Default, Failsafe Default
	Disable	
Enables or Disables BIOS support for security device. O.S. will not show Security Device. TCG EFI protocol and INT1A interface will not be available.		
SHA256 PCR Bank	Disabled	Optimal Default, Failsafe Default
	Enabled	
Enable or Disable SHA256 PCR Bank		
SHA384 PCR Bank	Disabled	Optimal Default, Failsafe Default
	Enabled	
Enable or Disable SHA384 PCR Bank		
Pending operation	None	Optimal Default, Failsafe Default
	TPM Clear	
Schedule an Operation for the Security Device. NOTE: Your Computer will reboot during restart in order to change State of Security Device.		
Platform Hierarchy	Disabled	Optimal Default, Failsafe Default
	Enabled	
Enable or Disable Platform Hierarchy		

Options Summary		
Storage Hierarchy	Disabled	
	Enabled	Optimal Default, Failsafe Default
Enable or Disable Storage Hierarchy		
Endorsement Hierarchy	Disabled	
	Enabled	Optimal Default, Failsafe Default
Enable or Disable Endorsement Hierarchy		
Physical Presence Spec Version	1.2	
	1.3	Optimal Default, Failsafe Default
Select to Tell O.S. to support PPI Spec Version 1.2 or 1.3. Note some HCK tests might not support 1.3.		
Device Select	TPM 1.2	
	TPM 2.0	
	Auto	Optimal Default, Failsafe Default
TPM 1.2 will restrict support to TPM 1.2 devices. TPM 2.0 will restrict support to TPM 2.0 devices. Auto will support both with the default set to TPM 2.0 devices if not found. TPM 1.2 devices will be enumerated.		

3.6.2 Secure Boot

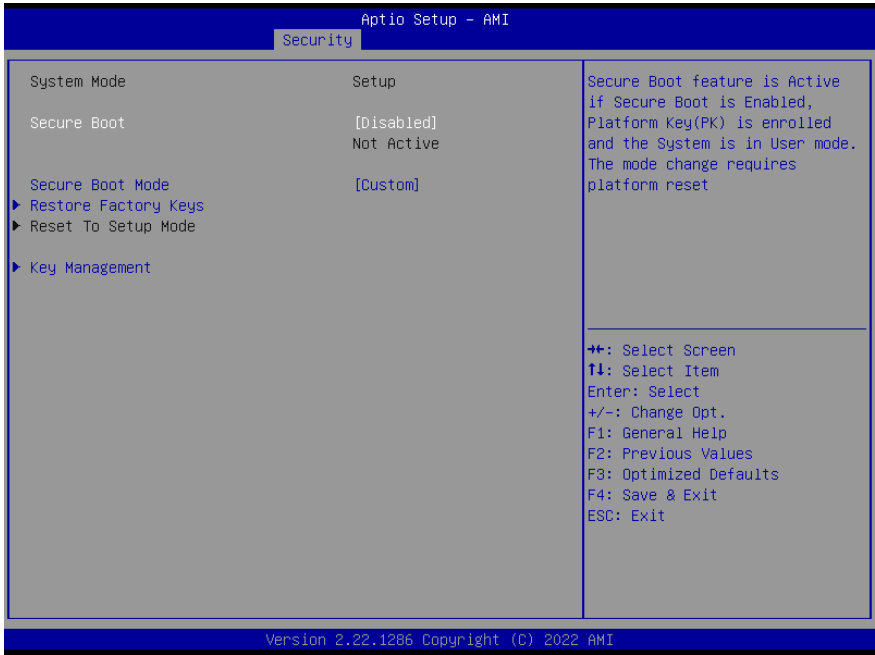

Options Summary		
Secure Boot	Disabled	Optimal Default, Failsafe Default
	Enabled	
Secure Boot feature is Active if Secure Boot is Enabled, Platform Key (PK) is enrolled and the System is in User mode. The mode change requires platform reset.		
Secure Boot Mode	Standard	Optimal Default, Failsafe Default
	Custom	
Secure Boot mode options: Standard or Custom. In Custom mode, Secure Boot Policy variables can be configured by a physically present user without full authentication.		
Restore Factory Keys	Yes	
	No	
Force System to User Mode. Install factory default Secure Boot key databases.		

3.6.2.1 Key Management

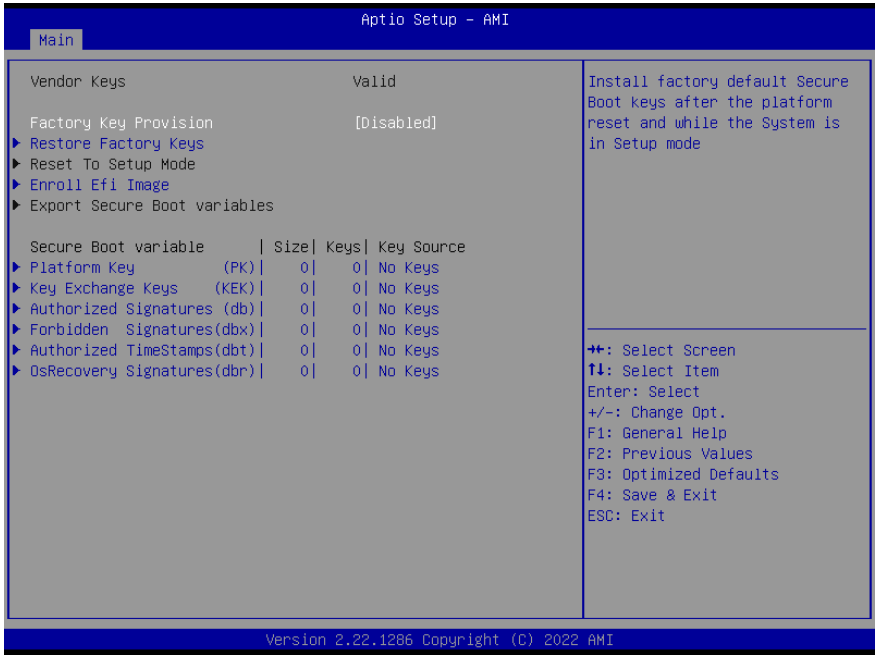

Options Summary		
Factory Key Provision	Disabled	Optimal Default, Failsafe Default
	Enabled	
Install factory default Secure Boot keys after the platform reset and while the System is in Setup mode.		
Restore Factory Keys	Yes	
	No	
Force System to User Mode. Install factory default Secure Boot key databases.		
Enroll Efi Image		
Allow Efi image to run in Secure Boot mode. Enroll SHA256 Hash certificate of a PE image into Authorized Signature Database (db).		
Platform Key (PK)	Update	
Key Exchange Keys (KEK)	Update	
	Append	
Authorized Signatures (db)	Update	
	Append	
Forbidden Signatures (dbx)	Update	
	Append	
Authorized TimeStamps	Update	

Options Summary	
(dbt)	Append
OsRecovery Signatures (dbr)	Update
	Append
Enroll Factory Defaults or load certificates from a file:	
1. Public Key Certificate:	
a) EFI_SIGNATURE_LIST	
b) EFI_CERT_X509 (DER)	
c) EFI_CERT_RSA2048 (bin)	
d) EFI_CERT_SHAXXX	
2. Authenticated UEFI Variable	
3. EFI PE/COFF Image (SHA256)	
Key Source: Factory, External, Mixed	

3.7 Setup Submenu: Boot

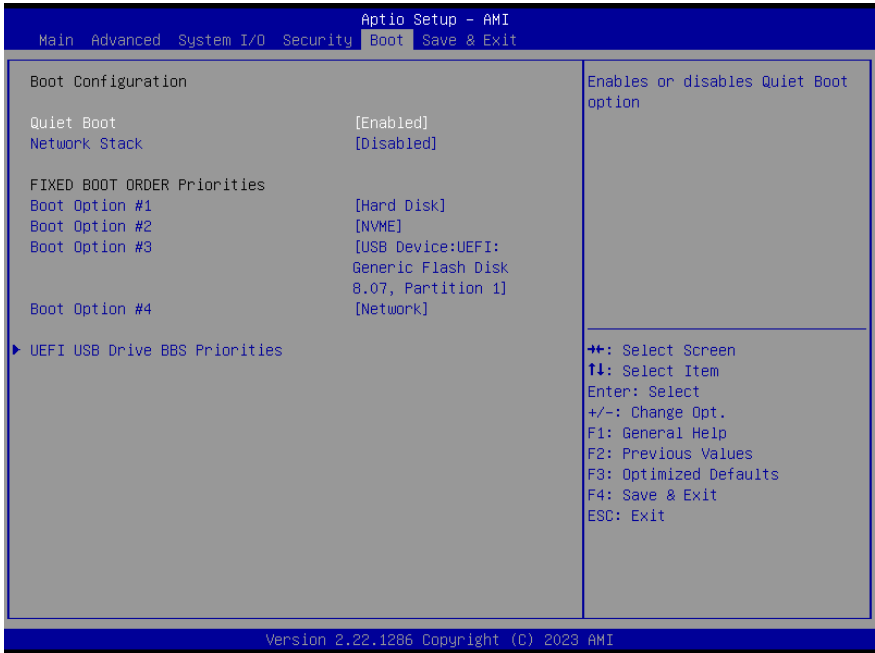

Options Summary		
Quiet Boot	Disabled	
	Enabled	Default
Enables/disables Quiet Boot option.		
Network Stack	Disabled	Default
	Enabled	
Enable/Disable UEFI Network Stack.		
Boot Option #1	Hard Disk	
Boot Option #2	NVME	
Boot Option #3	USB Device	
Boot Option #4	Network	
Sets the system boot order.		

3.7.1 UEFI BBS Priorities

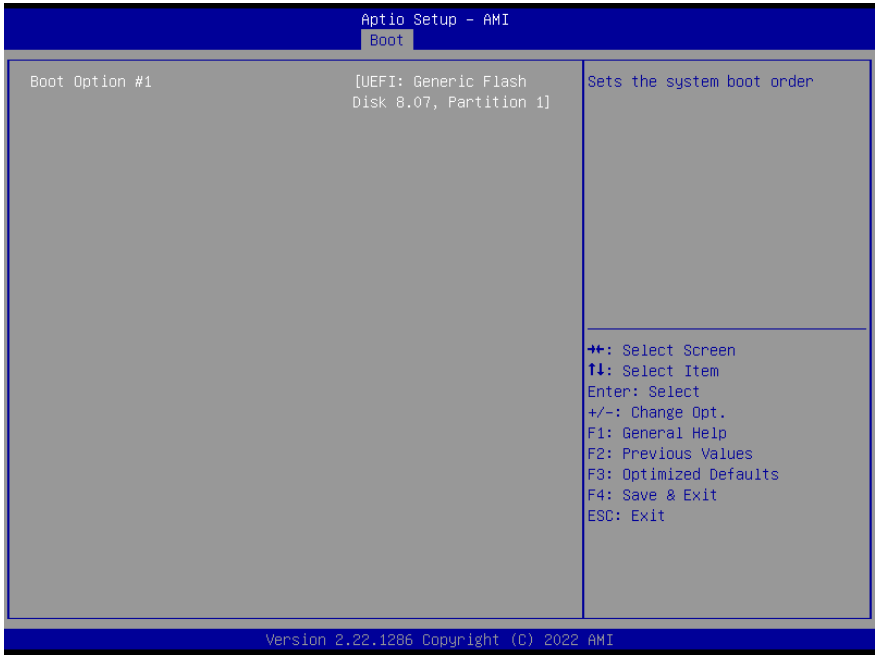

Options Summary		
Quiet Boot	Disabled	
	Enabled	Default
Enables/disables Quiet Boot option.		
Network Stack	Disabled	Default
	Enabled	
Enable/Disable UEFI Network Stack.		
Boot Option #1	Hard Disk	
Boot Option #2	NVME	
Boot Option #3	USB Device	
Boot Option #4	Network	
Sets the system boot order.		

3.8 Setup Submenu: Save & Exit



Chapter 4

Drivers Installation

4.1 Drivers Download and Installation

Drivers for the BOXER-6406U-ADN can be downloaded from the product page on the AAEON website by following this link:

<https://www.aaeon.com/en/product/detail/ultra-slim-fanless-boxer-6406u-adn/download>

Download the driver(s) you need and follow the steps below to install them.

Install Chipset Driver

1. Open the **Chipset** folder
2. Run the **SetupChipset.exe** file in the folder
3. Follow the instructions
4. Drivers will be installed automatically

Install Graphics Driver

1. Open the **Graphics** folder
2. Run the **Installer.exe** file in the folder
3. Follow the instructions
4. Drivers will be installed automatically

Install LAN Driver

1. Open the **LAN** folder
2. Run the **Wired_driver_28.0_x64.exe** file in the folder
3. Follow the instructions
4. Drivers will be installed automatically

Install ME & TXE Drivers

1. Open the **ME & TXE** folder
2. Run the **SetupME.exe** file in the folder
3. Follow the instructions
4. Drivers will be installed automatically

Install Serial Port Patch (Optional)

1. Open the **Serial Port Driver (Optional)** folder
2. Run the **FintekSerial.exe** file in the folder
3. Follow the instructions
4. Drivers will be installed automatically

Appendix A

I/O Information

A.1 I/O Address Map

The screenshot shows the Windows Device Manager window for a system named 'DESKTOP-IERI87C'. The 'Input/output (I/O)' category is expanded, displaying a list of hardware devices with their corresponding I/O address ranges. The devices listed include:

- PCI Express Root Complex
- Programmable interrupt controller (multiple instances)
- Motherboard resources (multiple instances)
- System timer (multiple instances)
- Fintek Communications Port (COM2) and (COM1)
- Intel(R) UHD Graphics
- Standard SATA AHCI Controller (multiple instances)
- Interrupt request (IRQ)
- Large Memory
- Memory

The address ranges for each device are shown in hexadecimal format, such as [0000000000000000 - 000000000000CF7] for the PCI Express Root Complex and [0000000000000000 - 0000000000000000] for the Interrupt request (IRQ).

A.2 Memory Address Map

The screenshot displays the Windows Device Manager interface for a system named 'DESKTOP-IERI87C'. The 'Memory' category is expanded, showing a list of hardware components with their respective memory addresses and names. The components listed include:

- PCI Express Root Complex
- Intel(R) Ethernet Controller I226-LM
- PCI Express Root Port #4 - 54B8
- PCI Express Root Complex
- Intel(R) Ethernet Controller I226-LM
- Intel(R) Ethernet Controller I226-LM #2
- PCI Express Root Port #3 - 54BA
- Intel(R) Ethernet Controller I226-LM #2
- Standard SATA AHCI Controller
- Standard SATA AHCI Controller
- Standard SATA AHCI Controller
- Motherboard resources
- SPI (flash) Controller - 54A4
- High precision event timer
- Motherboard resources
- Trusted Platform Module 2.0
- Motherboard resources
- Motherboard resources
- Motherboard resources
- Motherboard resources
- Motherboard resources
- Motherboard resources
- Intel(R) UHD Graphics
- Intel(R) UHD Graphics
- Intel(R) UHD Graphics
- Intel(R) UHD Graphics
- Intel(R) USB 3.10 eXtensible Host Controller - 1.20 (Microsoft)
- Intel(R) Management Engine Interface #1
- High Definition Audio Controller
- High Definition Audio Controller

A.3 Large Memory Address Map

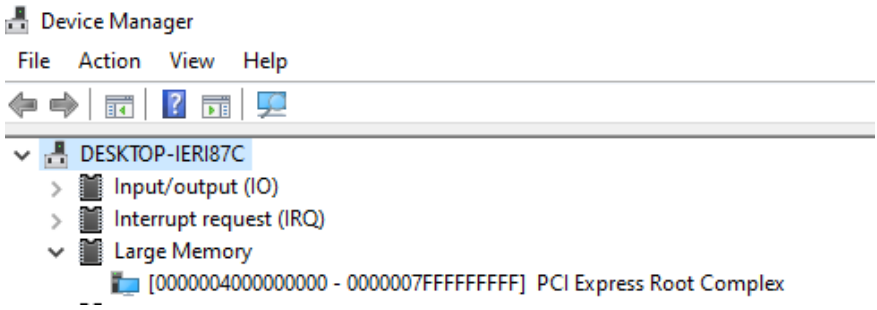

A.4 IRQ Mapping Chart

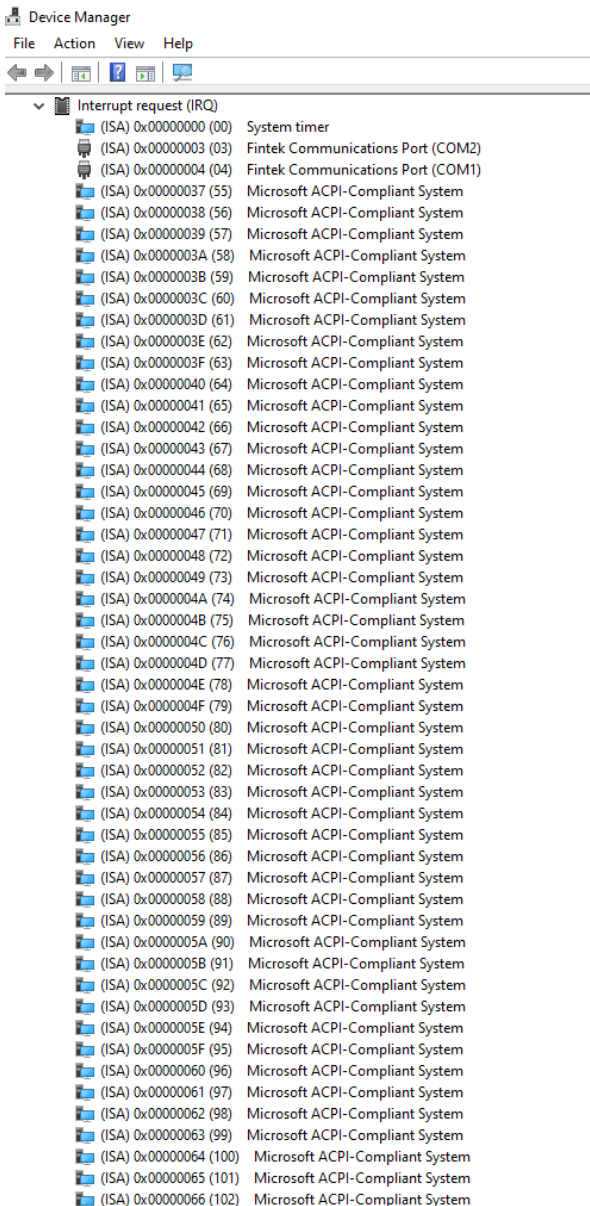

The screenshot shows the Windows Device Manager window with the 'Interrupt request (IRQ)' category expanded. The list contains 32 entries, each with an icon, an ID in parentheses, and a device name. The entries are as follows:

Device Name	IRQ ID
System timer	(ISA) 0x00000000 (00)
Fintek Communications Port (COM2)	(ISA) 0x00000003 (03)
Fintek Communications Port (COM1)	(ISA) 0x00000004 (04)
Microsoft ACPI-Compliant System	(ISA) 0x00000037 (55)
Microsoft ACPI-Compliant System	(ISA) 0x00000038 (56)
Microsoft ACPI-Compliant System	(ISA) 0x00000039 (57)
Microsoft ACPI-Compliant System	(ISA) 0x0000003A (58)
Microsoft ACPI-Compliant System	(ISA) 0x0000003B (59)
Microsoft ACPI-Compliant System	(ISA) 0x0000003C (60)
Microsoft ACPI-Compliant System	(ISA) 0x0000003D (61)
Microsoft ACPI-Compliant System	(ISA) 0x0000003E (62)
Microsoft ACPI-Compliant System	(ISA) 0x0000003F (63)
Microsoft ACPI-Compliant System	(ISA) 0x00000040 (64)
Microsoft ACPI-Compliant System	(ISA) 0x00000041 (65)
Microsoft ACPI-Compliant System	(ISA) 0x00000042 (66)
Microsoft ACPI-Compliant System	(ISA) 0x00000043 (67)
Microsoft ACPI-Compliant System	(ISA) 0x00000044 (68)
Microsoft ACPI-Compliant System	(ISA) 0x00000045 (69)
Microsoft ACPI-Compliant System	(ISA) 0x00000046 (70)
Microsoft ACPI-Compliant System	(ISA) 0x00000047 (71)
Microsoft ACPI-Compliant System	(ISA) 0x00000048 (72)
Microsoft ACPI-Compliant System	(ISA) 0x00000049 (73)
Microsoft ACPI-Compliant System	(ISA) 0x0000004A (74)
Microsoft ACPI-Compliant System	(ISA) 0x0000004B (75)
Microsoft ACPI-Compliant System	(ISA) 0x0000004C (76)
Microsoft ACPI-Compliant System	(ISA) 0x0000004D (77)
Microsoft ACPI-Compliant System	(ISA) 0x0000004E (78)
Microsoft ACPI-Compliant System	(ISA) 0x0000004F (79)
Microsoft ACPI-Compliant System	(ISA) 0x00000050 (80)
Microsoft ACPI-Compliant System	(ISA) 0x00000051 (81)
Microsoft ACPI-Compliant System	(ISA) 0x00000052 (82)
Microsoft ACPI-Compliant System	(ISA) 0x00000053 (83)
Microsoft ACPI-Compliant System	(ISA) 0x00000054 (84)
Microsoft ACPI-Compliant System	(ISA) 0x00000055 (85)
Microsoft ACPI-Compliant System	(ISA) 0x00000056 (86)
Microsoft ACPI-Compliant System	(ISA) 0x00000057 (87)
Microsoft ACPI-Compliant System	(ISA) 0x00000058 (88)
Microsoft ACPI-Compliant System	(ISA) 0x00000059 (89)
Microsoft ACPI-Compliant System	(ISA) 0x0000005A (90)
Microsoft ACPI-Compliant System	(ISA) 0x0000005B (91)
Microsoft ACPI-Compliant System	(ISA) 0x0000005C (92)
Microsoft ACPI-Compliant System	(ISA) 0x0000005D (93)
Microsoft ACPI-Compliant System	(ISA) 0x0000005E (94)
Microsoft ACPI-Compliant System	(ISA) 0x0000005F (95)
Microsoft ACPI-Compliant System	(ISA) 0x00000060 (96)
Microsoft ACPI-Compliant System	(ISA) 0x00000061 (97)
Microsoft ACPI-Compliant System	(ISA) 0x00000062 (98)
Microsoft ACPI-Compliant System	(ISA) 0x00000063 (99)
Microsoft ACPI-Compliant System	(ISA) 0x00000064 (100)
Microsoft ACPI-Compliant System	(ISA) 0x00000065 (101)
Microsoft ACPI-Compliant System	(ISA) 0x00000066 (102)

Device Manager

File Action View Help

	(ISA) 0x00000067 (103)	Microsoft ACPI-Compliant System
	(ISA) 0x00000068 (104)	Microsoft ACPI-Compliant System
	(ISA) 0x00000069 (105)	Microsoft ACPI-Compliant System
	(ISA) 0x0000006A (106)	Microsoft ACPI-Compliant System
	(ISA) 0x0000006B (107)	Microsoft ACPI-Compliant System
	(ISA) 0x0000006C (108)	Microsoft ACPI-Compliant System
	(ISA) 0x0000006D (109)	Microsoft ACPI-Compliant System
	(ISA) 0x0000006E (110)	Microsoft ACPI-Compliant System
	(ISA) 0x0000006F (111)	Microsoft ACPI-Compliant System
	(ISA) 0x00000070 (112)	Microsoft ACPI-Compliant System
	(ISA) 0x00000071 (113)	Microsoft ACPI-Compliant System
	(ISA) 0x00000072 (114)	Microsoft ACPI-Compliant System
	(ISA) 0x00000073 (115)	Microsoft ACPI-Compliant System
	(ISA) 0x00000074 (116)	Microsoft ACPI-Compliant System
	(ISA) 0x00000075 (117)	Microsoft ACPI-Compliant System
	(ISA) 0x00000076 (118)	Microsoft ACPI-Compliant System
	(ISA) 0x00000077 (119)	Microsoft ACPI-Compliant System
	(ISA) 0x00000078 (120)	Microsoft ACPI-Compliant System
	(ISA) 0x00000079 (121)	Microsoft ACPI-Compliant System
	(ISA) 0x0000007A (122)	Microsoft ACPI-Compliant System
	(ISA) 0x0000007B (123)	Microsoft ACPI-Compliant System
	(ISA) 0x0000007C (124)	Microsoft ACPI-Compliant System
	(ISA) 0x0000007D (125)	Microsoft ACPI-Compliant System
	(ISA) 0x0000007E (126)	Microsoft ACPI-Compliant System
	(ISA) 0x0000007F (127)	Microsoft ACPI-Compliant System
	(ISA) 0x00000080 (128)	Microsoft ACPI-Compliant System
	(ISA) 0x00000081 (129)	Microsoft ACPI-Compliant System
	(ISA) 0x00000082 (130)	Microsoft ACPI-Compliant System
	(ISA) 0x00000083 (131)	Microsoft ACPI-Compliant System
	(ISA) 0x00000084 (132)	Microsoft ACPI-Compliant System
	(ISA) 0x00000085 (133)	Microsoft ACPI-Compliant System
	(ISA) 0x00000086 (134)	Microsoft ACPI-Compliant System
	(ISA) 0x00000087 (135)	Microsoft ACPI-Compliant System
	(ISA) 0x00000088 (136)	Microsoft ACPI-Compliant System
	(ISA) 0x00000089 (137)	Microsoft ACPI-Compliant System
	(ISA) 0x0000008A (138)	Microsoft ACPI-Compliant System
	(ISA) 0x0000008B (139)	Microsoft ACPI-Compliant System
	(ISA) 0x0000008C (140)	Microsoft ACPI-Compliant System
	(ISA) 0x0000008D (141)	Microsoft ACPI-Compliant System
	(ISA) 0x0000008E (142)	Microsoft ACPI-Compliant System
	(ISA) 0x0000008F (143)	Microsoft ACPI-Compliant System
	(ISA) 0x00000090 (144)	Microsoft ACPI-Compliant System
	(ISA) 0x00000091 (145)	Microsoft ACPI-Compliant System
	(ISA) 0x00000092 (146)	Microsoft ACPI-Compliant System
	(ISA) 0x00000093 (147)	Microsoft ACPI-Compliant System
	(ISA) 0x00000094 (148)	Microsoft ACPI-Compliant System
	(ISA) 0x00000095 (149)	Microsoft ACPI-Compliant System
	(ISA) 0x00000096 (150)	Microsoft ACPI-Compliant System
	(ISA) 0x00000097 (151)	Microsoft ACPI-Compliant System
	(ISA) 0x00000098 (152)	Microsoft ACPI-Compliant System
	(ISA) 0x00000099 (153)	Microsoft ACPI-Compliant System
	(ISA) 0x0000009A (154)	Microsoft ACPI-Compliant System

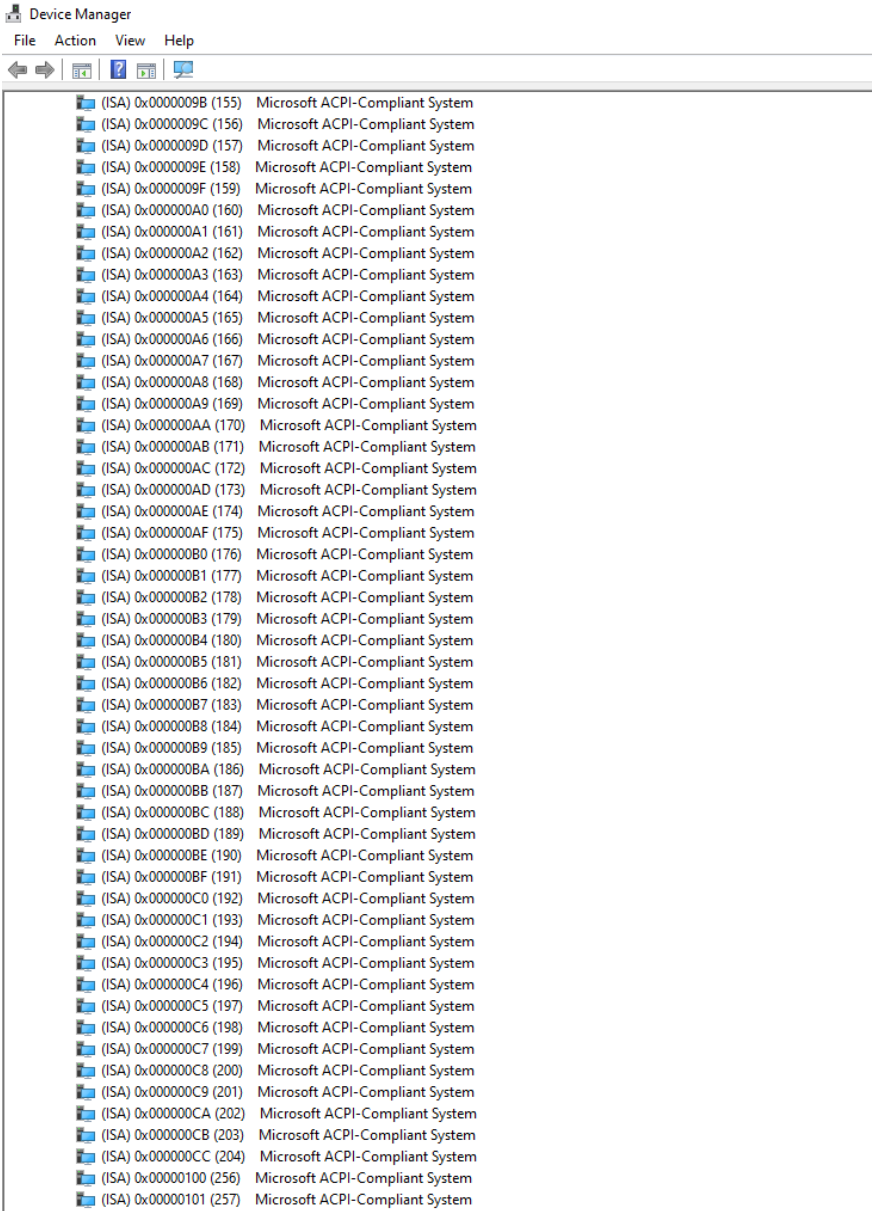

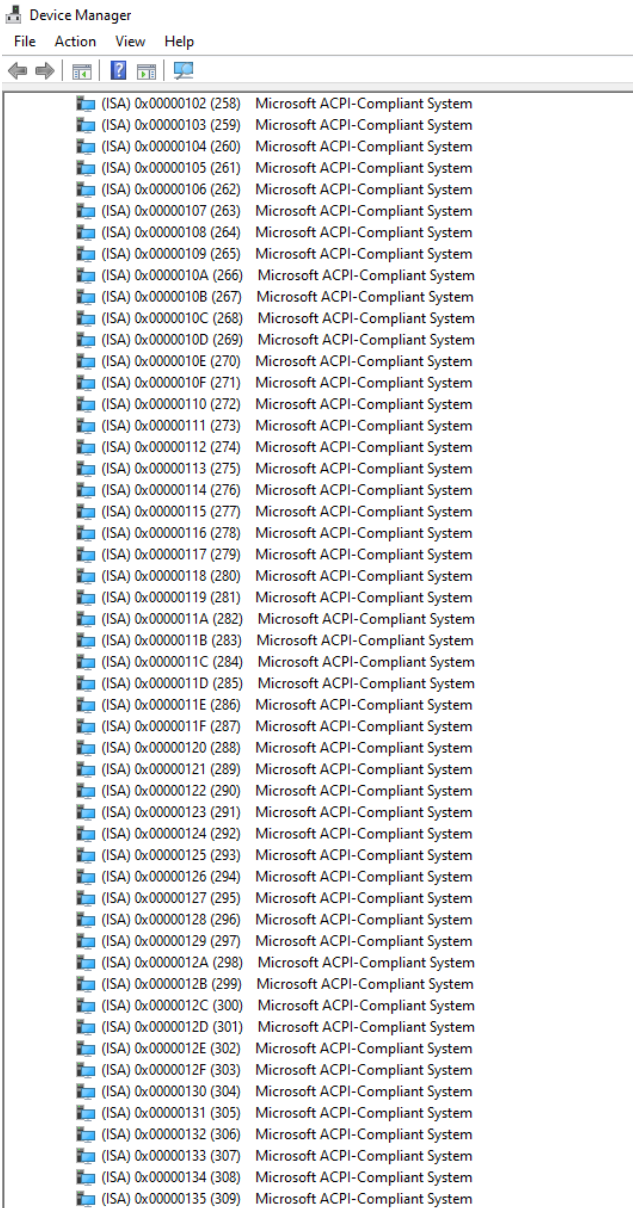

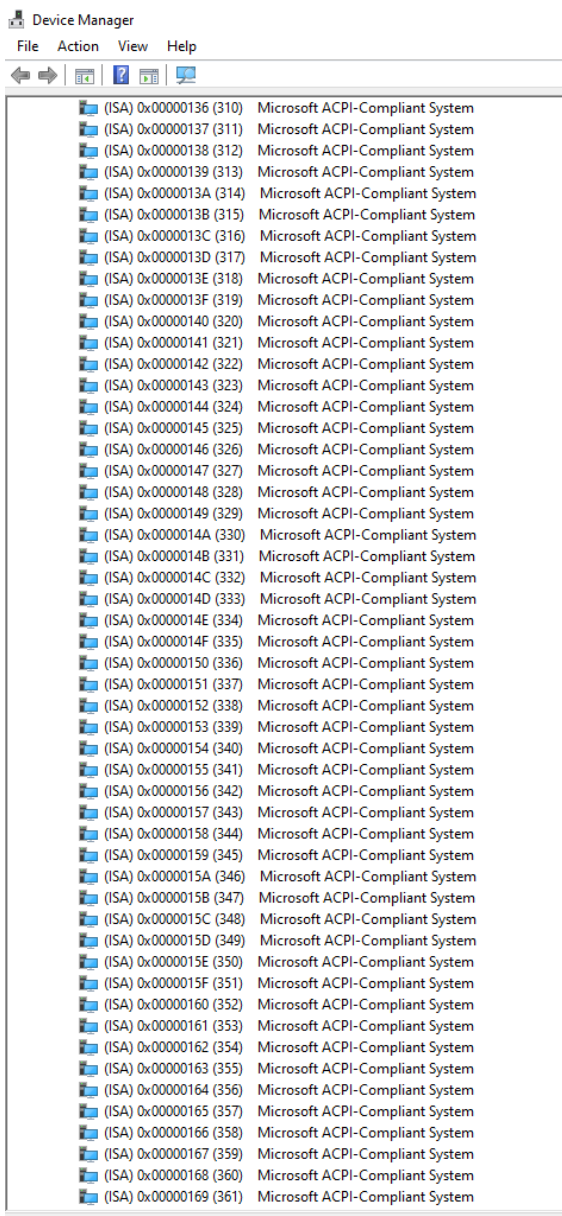

Device Manager

File Action View Help



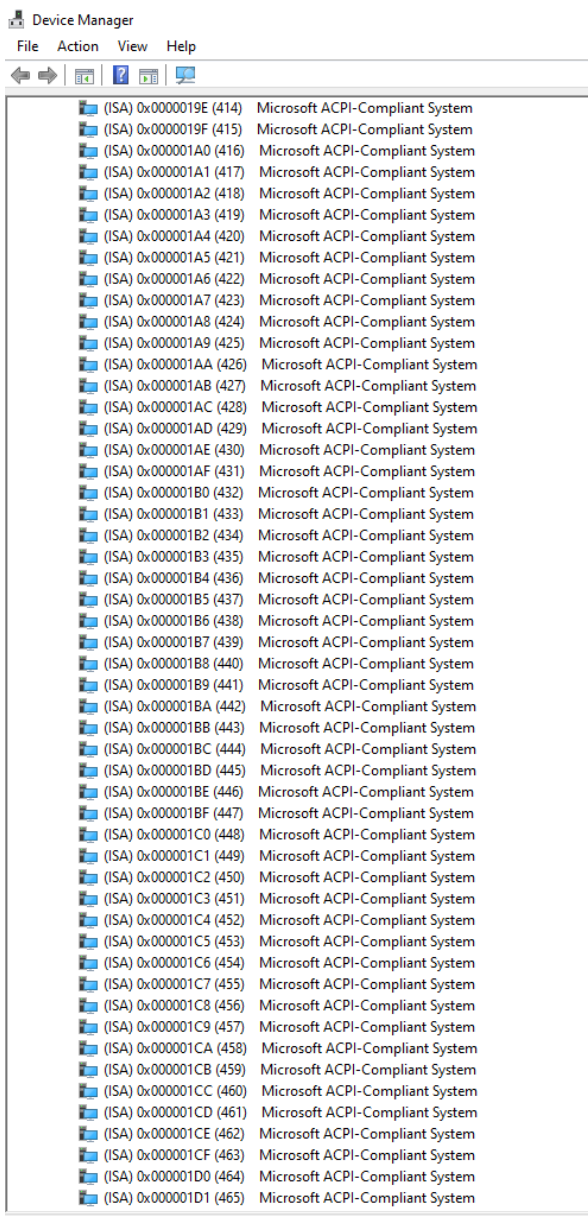

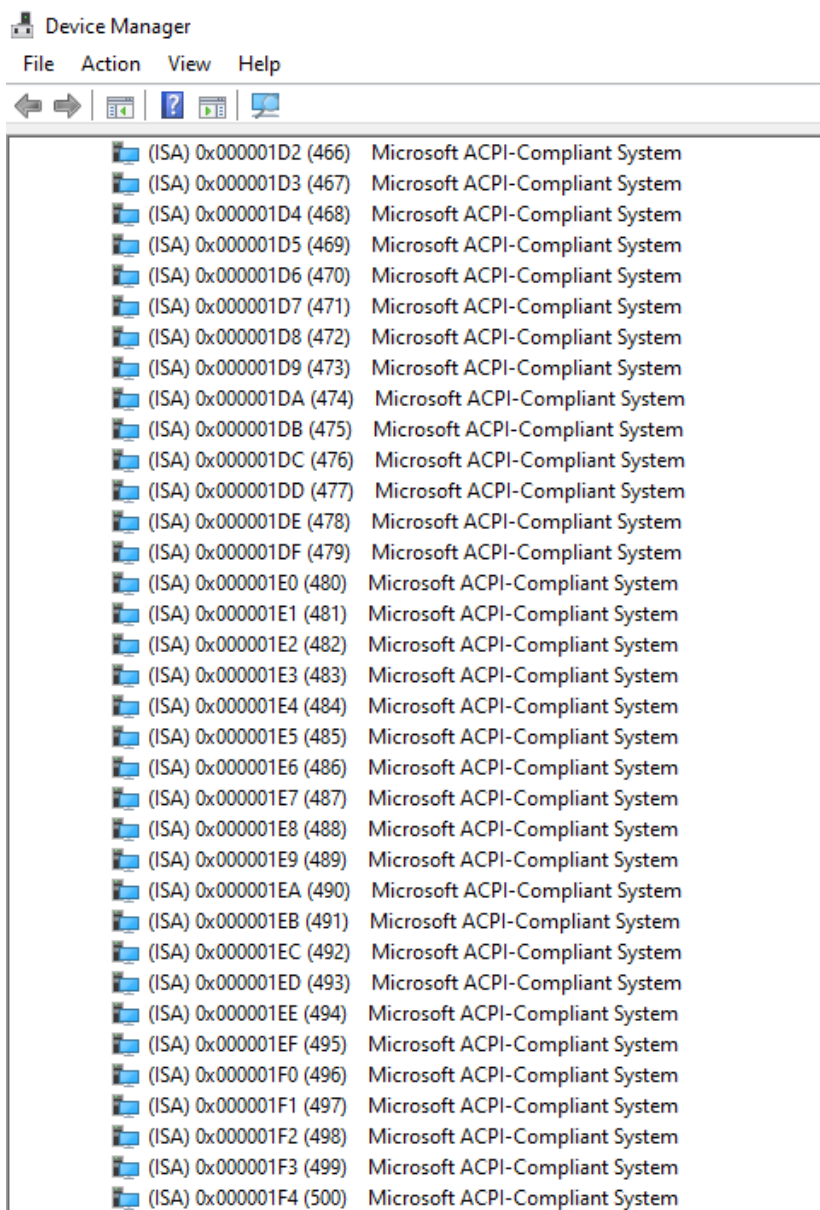





















(ISA) 0x0000016A (362)	Microsoft ACPI-Compliant System
(ISA) 0x0000016B (363)	Microsoft ACPI-Compliant System
(ISA) 0x0000016C (364)	Microsoft ACPI-Compliant System
(ISA) 0x0000016D (365)	Microsoft ACPI-Compliant System
(ISA) 0x0000016E (366)	Microsoft ACPI-Compliant System
(ISA) 0x0000016F (367)	Microsoft ACPI-Compliant System
(ISA) 0x00000170 (368)	Microsoft ACPI-Compliant System
(ISA) 0x00000171 (369)	Microsoft ACPI-Compliant System
(ISA) 0x00000172 (370)	Microsoft ACPI-Compliant System
(ISA) 0x00000173 (371)	Microsoft ACPI-Compliant System
(ISA) 0x00000174 (372)	Microsoft ACPI-Compliant System
(ISA) 0x00000175 (373)	Microsoft ACPI-Compliant System
(ISA) 0x00000176 (374)	Microsoft ACPI-Compliant System
(ISA) 0x00000177 (375)	Microsoft ACPI-Compliant System
(ISA) 0x00000178 (376)	Microsoft ACPI-Compliant System
(ISA) 0x00000179 (377)	Microsoft ACPI-Compliant System
(ISA) 0x0000017A (378)	Microsoft ACPI-Compliant System
(ISA) 0x0000017B (379)	Microsoft ACPI-Compliant System
(ISA) 0x0000017C (380)	Microsoft ACPI-Compliant System
(ISA) 0x0000017D (381)	Microsoft ACPI-Compliant System
(ISA) 0x0000017E (382)	Microsoft ACPI-Compliant System
(ISA) 0x0000017F (383)	Microsoft ACPI-Compliant System
(ISA) 0x00000180 (384)	Microsoft ACPI-Compliant System
(ISA) 0x00000181 (385)	Microsoft ACPI-Compliant System
(ISA) 0x00000182 (386)	Microsoft ACPI-Compliant System
(ISA) 0x00000183 (387)	Microsoft ACPI-Compliant System
(ISA) 0x00000184 (388)	Microsoft ACPI-Compliant System
(ISA) 0x00000185 (389)	Microsoft ACPI-Compliant System
(ISA) 0x00000186 (390)	Microsoft ACPI-Compliant System
(ISA) 0x00000187 (391)	Microsoft ACPI-Compliant System
(ISA) 0x00000188 (392)	Microsoft ACPI-Compliant System
(ISA) 0x00000189 (393)	Microsoft ACPI-Compliant System
(ISA) 0x0000018A (394)	Microsoft ACPI-Compliant System
(ISA) 0x0000018B (395)	Microsoft ACPI-Compliant System
(ISA) 0x0000018C (396)	Microsoft ACPI-Compliant System
(ISA) 0x0000018D (397)	Microsoft ACPI-Compliant System
(ISA) 0x0000018E (398)	Microsoft ACPI-Compliant System
(ISA) 0x0000018F (399)	Microsoft ACPI-Compliant System
(ISA) 0x00000190 (400)	Microsoft ACPI-Compliant System
(ISA) 0x00000191 (401)	Microsoft ACPI-Compliant System
(ISA) 0x00000192 (402)	Microsoft ACPI-Compliant System
(ISA) 0x00000193 (403)	Microsoft ACPI-Compliant System
(ISA) 0x00000194 (404)	Microsoft ACPI-Compliant System
(ISA) 0x00000195 (405)	Microsoft ACPI-Compliant System
(ISA) 0x00000196 (406)	Microsoft ACPI-Compliant System
(ISA) 0x00000197 (407)	Microsoft ACPI-Compliant System
(ISA) 0x00000198 (408)	Microsoft ACPI-Compliant System
(ISA) 0x00000199 (409)	Microsoft ACPI-Compliant System
(ISA) 0x0000019A (410)	Microsoft ACPI-Compliant System
(ISA) 0x0000019B (411)	Microsoft ACPI-Compliant System
(ISA) 0x0000019C (412)	Microsoft ACPI-Compliant System
(ISA) 0x0000019D (413)	Microsoft ACPI-Compliant System





The screenshot displays the Windows Device Manager window. The title bar reads "Device Manager" and the menu bar includes "File", "Action", "View", and "Help". Below the menu is a toolbar with navigation and help icons. The main area shows a list of 33 devices, all of which are "Microsoft ACPI-Compliant System" devices. Each entry includes a folder icon, the device name, its hexadecimal ID in parentheses, and the full name of the device.

Device Name	Device ID	Manufacturer
(ISA) 0x000001D2 (466)	0x000001D2 (466)	Microsoft ACPI-Compliant System
(ISA) 0x000001D3 (467)	0x000001D3 (467)	Microsoft ACPI-Compliant System
(ISA) 0x000001D4 (468)	0x000001D4 (468)	Microsoft ACPI-Compliant System
(ISA) 0x000001D5 (469)	0x000001D5 (469)	Microsoft ACPI-Compliant System
(ISA) 0x000001D6 (470)	0x000001D6 (470)	Microsoft ACPI-Compliant System
(ISA) 0x000001D7 (471)	0x000001D7 (471)	Microsoft ACPI-Compliant System
(ISA) 0x000001D8 (472)	0x000001D8 (472)	Microsoft ACPI-Compliant System
(ISA) 0x000001D9 (473)	0x000001D9 (473)	Microsoft ACPI-Compliant System
(ISA) 0x000001DA (474)	0x000001DA (474)	Microsoft ACPI-Compliant System
(ISA) 0x000001DB (475)	0x000001DB (475)	Microsoft ACPI-Compliant System
(ISA) 0x000001DC (476)	0x000001DC (476)	Microsoft ACPI-Compliant System
(ISA) 0x000001DD (477)	0x000001DD (477)	Microsoft ACPI-Compliant System
(ISA) 0x000001DE (478)	0x000001DE (478)	Microsoft ACPI-Compliant System
(ISA) 0x000001DF (479)	0x000001DF (479)	Microsoft ACPI-Compliant System
(ISA) 0x000001E0 (480)	0x000001E0 (480)	Microsoft ACPI-Compliant System
(ISA) 0x000001E1 (481)	0x000001E1 (481)	Microsoft ACPI-Compliant System
(ISA) 0x000001E2 (482)	0x000001E2 (482)	Microsoft ACPI-Compliant System
(ISA) 0x000001E3 (483)	0x000001E3 (483)	Microsoft ACPI-Compliant System
(ISA) 0x000001E4 (484)	0x000001E4 (484)	Microsoft ACPI-Compliant System
(ISA) 0x000001E5 (485)	0x000001E5 (485)	Microsoft ACPI-Compliant System
(ISA) 0x000001E6 (486)	0x000001E6 (486)	Microsoft ACPI-Compliant System
(ISA) 0x000001E7 (487)	0x000001E7 (487)	Microsoft ACPI-Compliant System
(ISA) 0x000001E8 (488)	0x000001E8 (488)	Microsoft ACPI-Compliant System
(ISA) 0x000001E9 (489)	0x000001E9 (489)	Microsoft ACPI-Compliant System
(ISA) 0x000001EA (490)	0x000001EA (490)	Microsoft ACPI-Compliant System
(ISA) 0x000001EB (491)	0x000001EB (491)	Microsoft ACPI-Compliant System
(ISA) 0x000001EC (492)	0x000001EC (492)	Microsoft ACPI-Compliant System
(ISA) 0x000001ED (493)	0x000001ED (493)	Microsoft ACPI-Compliant System
(ISA) 0x000001EE (494)	0x000001EE (494)	Microsoft ACPI-Compliant System
(ISA) 0x000001EF (495)	0x000001EF (495)	Microsoft ACPI-Compliant System
(ISA) 0x000001F0 (496)	0x000001F0 (496)	Microsoft ACPI-Compliant System
(ISA) 0x000001F1 (497)	0x000001F1 (497)	Microsoft ACPI-Compliant System
(ISA) 0x000001F2 (498)	0x000001F2 (498)	Microsoft ACPI-Compliant System
(ISA) 0x000001F3 (499)	0x000001F3 (499)	Microsoft ACPI-Compliant System
(ISA) 0x000001F4 (500)	0x000001F4 (500)	Microsoft ACPI-Compliant System

	(ISA) 0x000001F5 (501)	Microsoft ACPI-Compliant System
	(ISA) 0x000001F6 (502)	Microsoft ACPI-Compliant System
	(ISA) 0x000001F7 (503)	Microsoft ACPI-Compliant System
	(ISA) 0x000001F8 (504)	Microsoft ACPI-Compliant System
	(ISA) 0x000001F9 (505)	Microsoft ACPI-Compliant System
	(ISA) 0x000001FA (506)	Microsoft ACPI-Compliant System
	(ISA) 0x000001FB (507)	Microsoft ACPI-Compliant System
	(ISA) 0x000001FC (508)	Microsoft ACPI-Compliant System
	(ISA) 0x000001FD (509)	Microsoft ACPI-Compliant System
	(ISA) 0x000001FE (510)	Microsoft ACPI-Compliant System
	(ISA) 0x000001FF (511)	Microsoft ACPI-Compliant System
	(PCI) 0x00000010 (16)	High Definition Audio Controller
	(PCI) 0xFFFFFFFF1 (-15)	Intel(R) UHD Graphics
	(PCI) 0xFFFFFFFF2 (-14)	Intel(R) Management Engine Interface #1
	(PCI) 0xFFFFFFFF3 (-13)	Intel(R) Ethernet Controller I226-LM #2
	(PCI) 0xFFFFFFFF4 (-12)	Intel(R) Ethernet Controller I226-LM #2
	(PCI) 0xFFFFFFFF5 (-11)	Intel(R) Ethernet Controller I226-LM #2
	(PCI) 0xFFFFFFFF6 (-10)	Intel(R) Ethernet Controller I226-LM #2
	(PCI) 0xFFFFFFFF7 (-9)	Intel(R) Ethernet Controller I226-LM #2
	(PCI) 0xFFFFFFFF8 (-8)	Intel(R) Ethernet Controller I226-LM
	(PCI) 0xFFFFFFFF9 (-7)	Intel(R) Ethernet Controller I226-LM
	(PCI) 0xFFFFFFFFA (-6)	Intel(R) Ethernet Controller I226-LM
	(PCI) 0xFFFFFFFFB (-5)	Intel(R) Ethernet Controller I226-LM
	(PCI) 0xFFFFFFFFC (-4)	Intel(R) Ethernet Controller I226-LM
	(PCI) 0xFFFFFFFFD (-3)	Intel(R) USB 3.10 eXtensible Host Controller - 1.20 (Microsoft)
	(PCI) 0xFFFFFFFFE (-2)	Standard SATA AHCI Controller