

BIO-ST02-C4M1

BIO Daughter Board

User Manual 2nd Ed

Copyright Notice

This document is copyrighted, 2019. All rights are reserved. The original manufacturer reserves the right to make improvements to the products described in this manual at any time without notice.

No part of this manual may be reproduced, copied, translated, or transmitted in any form or by any means without the prior written permission of the original manufacturer. Information provided in this manual is intended to be accurate and reliable. However, the original manufacturer assumes no responsibility for its use, or for any infringements upon the rights of third parties that may result from its use.

The material in this document is for product information only and is subject to change without notice. While reasonable efforts have been made in the preparation of this document to assure its accuracy, AAEMON assumes no liabilities resulting from errors or omissions in this document, or from the use of the information contained herein.

AAEMON reserves the right to make changes in the product design without notice to its users.

Acknowledgement

All other products' name or trademarks are properties of their respective owners.

- Microsoft Windows is a registered trademark of Microsoft Corp.
- Intel, Pentium, Celeron, and Xeon are registered trademarks of Intel Corporation
- Core, Atom are trademarks of Intel Corporation
- ITE is a trademark of Integrated Technology Express, Inc.
- IBM, PC/AT, PS/2, and VGA are trademarks of International Business Machines Corporation.

All other product names or trademarks are properties of their respective owners.

Packing List

Before setting up your product, please make sure the following items have been shipped:

Item	Quantity
● BIO-ST02-C4M1 BIO Daughter Board	1
● Accessory kit	1
● COM Port cable	2

If any of these items are missing or damaged, please contact your distributor or sales representative immediately.

About this Document

This User's Manual contains all the essential information, such as detailed descriptions and explanations on the product's hardware and software features (if any), its specifications, dimensions, jumper/connector settings/definitions, and driver installation instructions (if any), to facilitate users in setting up their product.

Users may refer to the AAEON.com for the latest version of this document.

Safety Precautions

Please read the following safety instructions carefully. It is advised that you keep this manual for future references

1. All cautions and warnings on the device should be noted.
2. Make sure the power source matches the power rating of the device.
3. Position the power cord so that people cannot step on it. Do not place anything over the power cord.
4. Always completely disconnect the power before working on the system's hardware.
5. No connections should be made when the system is powered as a sudden rush of power may damage sensitive electronic components.
6. If the device is not to be used for a long time, disconnect it from the power supply to avoid damage by transient over-voltage.
7. Always disconnect this device from any AC supply before cleaning.
8. While cleaning, use a damp cloth instead of liquid or spray detergents.
9. Make sure the device is installed near a power outlet and is easily accessible.
10. Keep this device away from humidity.
11. Place the device on a solid surface during installation to prevent falls
12. Do not cover the openings on the device to ensure optimal heat dissipation.
13. Watch out for high temperatures when the system is running.
14. Do not touch the heat sink or heat spreader when the system is running
15. Never pour any liquid into the openings. This could cause fire or electric shock.
16. As most electronic components are sensitive to static electrical charge, be sure to ground yourself to prevent static charge when installing the internal components. Use a grounding wrist strap and contain all electronic components in any static-shielded containers.

17. If any of the following situations arises, please the contact our service personnel:
 - i. Damaged power cord or plug
 - ii. Liquid intrusion to the device
 - iii. Exposure to moisture
 - iv. Device is not working as expected or in a manner as described in this manual
 - v. The device is dropped or damaged
 - vi. Any obvious signs of damage displayed on the device
18. **DO NOT LEAVE THIS DEVICE IN AN UNCONTROLLED ENVIRONMENT WITH TEMPERATURES BEYOND THE DEVICE'S PERMITTED STORAGE TEMPERATURES (SEE CHAPTER 1) TO PREVENT DAMAGE.**

Warning!



This device complies with Part 15 FCC Rules. Operation is subject to the following two conditions: (1) this device may not cause harmful interference, and (2) this device must accept any interference received including interference that may cause undesired operation.

Caution:

There is a danger of explosion if the battery is incorrectly replaced. Replace only with the same or equivalent type recommended by the manufacturer. Dispose of used batteries according to the manufacturer's instructions and your local government's recycling or disposal directives.

Attention:

Il y a un risque d'explosion si la batterie est remplacée de façon incorrecte. Ne la remplacer qu'avec le même modèle ou équivalent recommandé par le constructeur. Recycler les batteries usées en accord avec les instructions du fabricant et les directives gouvernementales de recyclage.

China RoHS Requirements (CN)

产品中有毒有害物质或元素名称及含量

AAEON Main Board/ Daughter Board/ Backplane

部件名称	有毒有害物质或元素					
	铅 (Pb)	汞 (Hg)	镉 (Cd)	六价铬 (Cr(VI))	多溴联苯 (PBB)	多溴二苯醚 (PBDE)
印刷电路板 及其电子组件	×	○	○	○	○	○
外部信号 连接器及线材	×	○	○	○	○	○
<p>O: 表示该有毒有害物质在该部件所有均质材料中的含量均在 SJ/T 11363-2006 标准规定的限量要求以下。</p> <p>X: 表示该有毒有害物质至少在该部件的某一均质材料中的含量超出 SJ/T 11363-2006 标准规定的限量要求。</p> <p>备注: 此产品所标示之环保使用期限, 系指在一般正常使用状况下。</p>						

China RoHS Requirement (EN)

Poisonous or Hazardous Substances or Elements in Products

AAEON Main Board/ Daughter Board/ Backplane

Component	Poisonous or Hazardous Substances or Elements					
	Lead (Pb)	Mercury (Hg)	Cadmium (Cd)	Hexavalent Chromium (Cr(VI))	Polybrominated Biphenyls (PBB)	Polybrominated Diphenyl Ethers (PBDE)
PCB & Other Components	X	○	○	○	○	○
Wires & Connectors for External Connections	X	○	○	○	○	○
<p>O: The quantity of poisonous or hazardous substances or elements found in each of the component's parts is below the SJ/T 11363-2006-stipulated requirement.</p> <p>X: The quantity of poisonous or hazardous substances or elements found in at least one of the component's parts is beyond the SJ/T 11363-2006-stipulated requirement.</p> <p>Note: The Environment Friendly Use Period as labeled on this product is applicable under normal usage only</p>						

Table of Contents

Chapter 1 - Product Specifications	1
1.1 Specifications	2
Chapter 2 – Hardware Information	3
2.1 Dimensions, Jumpers and Connectors	4
2.2 Block Diagram	6
2.3 List of Connectors.....	7
2.3.1 UIM Card Socket (CN1)	8
2.3.2 MiniCard Slot (Full-MiniCard) (CN2).....	8
2.3.3 COM Port 2 (CN4).....	10
2.3.4 COM Port 1 (CN5)	11
2.3.5 USB 2.0 Port 1 (CN6).....	11
2.3.6 COM Port 4 (D-SUB 9) (CN7)	12
2.3.7 COM Port 3 (D-SUB 9) (CN9)	12
2.3.8 BIO Connector (CN10).....	13
Chapter 3 – BIOS and Drivers Installation	18
3.1 BIOS Update	19
3.2 Drivers Installation	20

Chapter 1

Product Specifications

1.1 Specifications

System

Form Factor	2.5" Board
BIO	80 Pin high speed Board to board connector
Power Requirement	Power Supplied from MB via board to board connector
Dimension	3.94" x 2.84" (100mm x 72mm)
Gross Weight	0.44 lb (0.2 Kg)
Operating Temperature	32°F ~ 140°F (0°C ~ 60°C)
Storage Temperature	-40 °F ~ 176°F (-40°C ~ 80°C)
Operating Humidity	0% ~ 90% relative humidity, non-condensing

I/O

Serial Port	COM1, COM2 RS-232 by Pin Header COM3, COM4 RS-232 on Rear I/O
USB	USB 2.0 x 1 on rear I/O
PCle	Mini-Card x 1 (full size), SIM x 1

Chapter 2

Hardware Information

2.1 Dimensions, Jumpers and Connectors

Component Side

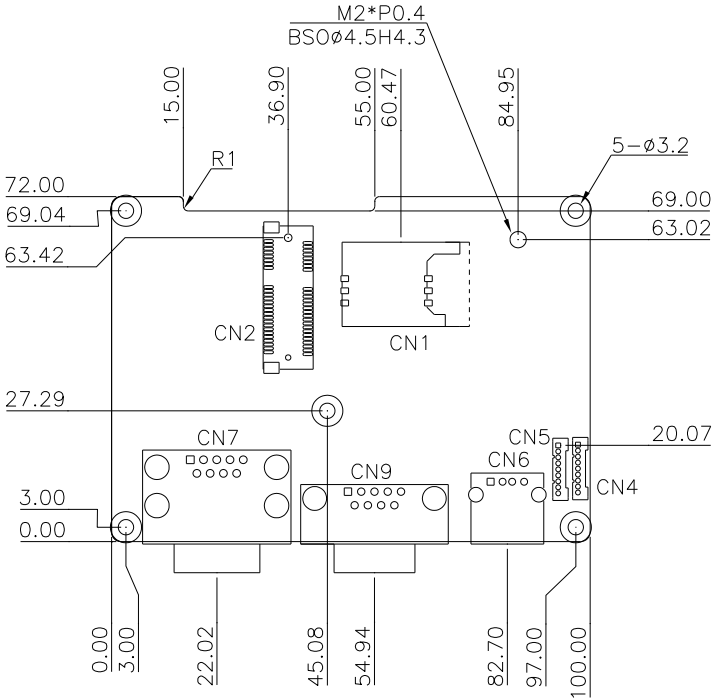

Solder Side

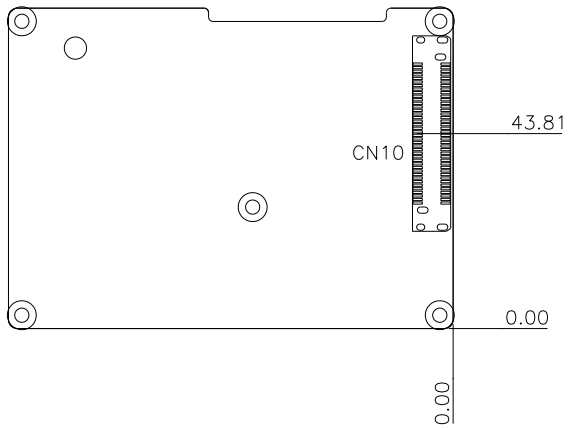
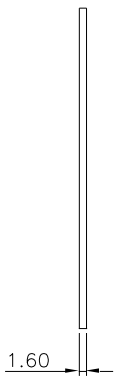

2.2 Block Diagram

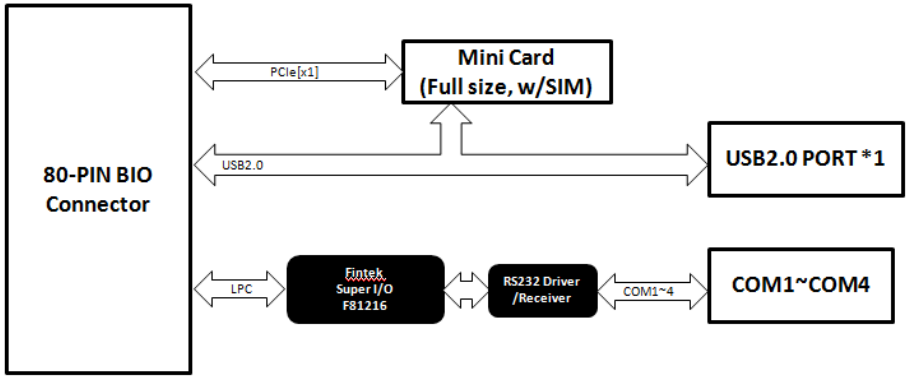

2.3 List of Connectors

Please refer to the table below for all of the board's jumpers that you can configure for your application

Label	Function
CN1	UIM Card Socket
CN2	MiniCard Slot (Full-MiniCard)
CN4	COM Port 2
CN5	COM Port 1
CN6	USB 2.0 Port 1
CN7	COM Port 4 (D-SUB 9)
CN9	COM Port 3 (D-SUB 9)
CN10	BIO Connector

2.3.1 UIM Card Socket (CN1)

Pin	Pin Name	Signal Type	Signal level
1	UIM_PWR	PWR	
2	UIM_RST	IN	
3	UIM_CLK	IN	
4	GND	GND	
5	UIM_VPP	PWR	
6	UIM_DATA	I/O	

2.3.2 MiniCard Slot (Full-MiniCard) (CN2)

Pin	Pin Name	Signal Type	Signal level
1	PCIE_WAKE#	IN	
2	+3.3VSB	PWR	+3.3V
3	NC		
4	GND	GND	
5	NC		
6	+1.5V	PWR	+1.5V
7	PCIE_CLK_REQ#	IN	
8	UIM_PWR	PWR	
9	GND	GND	
10	UIM_DATA	I/O	
11	PCIE_REF_CLK-	DIFF	
12	UIM_CLK	IN	
13	PCIE_REF_CLK+	DIFF	
14	UIM_RST	IN	

15	GND	GND	
16	UIM_VPP	PWR	
17	NC		
18	GND	GND	
19	NC		
20	W_DISABLE#	OUT	+3.3V
21	GND	GND	
22	PCIE_RST#	OUT	+3.3V
23	PCIE_RX-	DIFF	
24	+3.3VSB	PWR	+3.3V
25	PCIE_RX+	DIFF	
26	GND	GND	
27	GND	GND	
28	+1.5V	PWR	+1.5V
29	GND	GND	
30	SMB_CLK	I/O	+3.3V
31	PCIE_TX-	DIFF	
32	SMB_DATA	I/O	+3.3V
33	PCIE_TX+	DIFF	
34	GND	GND	
35	GND	GND	
36	USB_D-	DIFF	
37	GND	GND	
38	USB_D+	DIFF	
39	+3.3VSB	PWR	+3.3V
40	GND	GND	
41	+3.3VSB	PWR	+3.3V

42	NC		
43	GND	GND	
44	NC		
45	NC		
46	NC		
47	NC		
48	+1.5V	PWR	+1.5V
49	NC		
50	GND	GND	
51	NC		
52	+3.3VSB	PWR	+3.3V

2.3.3 COM Port 2 (CN4)

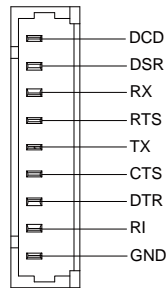

Pin	Pin Name	Signal Type	Signal level
1	DCD	IN	
2	DSR	IN	
3	RX	IN	
4	RTS	OUT	±9V
5	TX	OUT	±9V
6	CTS	IN	

7	DTR	OUT	±9V
8	RI	IN	
9	GND	GND	

2.3.4 COM Port 1 (CN5)

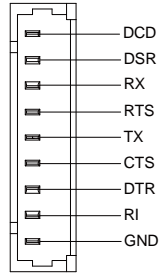

Pin	Pin Name	Signal Type	Signal level
1	DCD	IN	
2	DSR	IN	
3	RX	IN	
4	RTS	OUT	±9V
5	TX	OUT	±9V
6	CTS	IN	
7	DTR	OUT	±9V
8	RI	IN	
9	GND	GND	

2.3.5 USB 2.0 Port 1 (CN6)

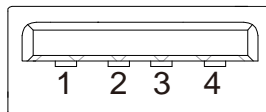

Pin	Pin Name	Signal Type	Signal level
1	+5VSB	PWR	+5V
2	USB_D-	DIFF	
3	USB_D+	DIFF	
4	GND	GND	

2.3.6 COM Port 4 (D-SUB 9) (CN7)

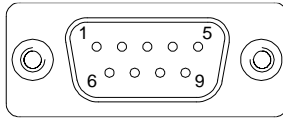

Pin	Pin Name	Signal Type	Signal level
1	DCD	IN	
2	RX	IN	
3	TX	OUT	±9V
4	DTR	OUT	±9V
5	GND	GND	
6	DSR	IN	
7	RTS	OUT	±9V
8	CTS	IN	
9	RI	IN	

2.3.7 COM Port 3 (D-SUB 9) (CN9)

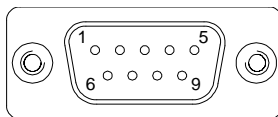

Pin	Pin Name	Signal Type	Signal level
1	DCD	IN	
2	RX	IN	
3	TX	OUT	±9V
4	DTR	OUT	±9V
5	GND	GND	
6	DSR	IN	
7	RTS	OUT	±9V
8	CTS	IN	
9	RI	IN	

2.3.8 BIO Connector (CN10)

Pin	Pin Name	Signal Type	Signal level
1	+12VSB	PWR	+12V
2	GND	GND	
3	GND	GND	
4	PCIE_TXN0	DIFF	
5	PCIE_RXN0	DIFF	
6	PCIE_TXP0	DIFF	
7	PCIE_RXP0	DIFF	
8	GND	GND	
9	GND	GND	
10	NC		

11	NC		
12	NC		
13	NC		
14	GND	GND	
15	GND	GND	
16	PS_ON#	IN	
17	NC		
18	NC		
19	+5VSB	PWR	+5V
20	+5VSB	PWR	+5V
21	+5VSB	PWR	+5V
22	+5VSB	PWR	+5V
23	PCIE_REF_CLK0	DIFF	
24	RESET#	IN	
25	PCIE_REF_CLK0#	DIFF	
26	GND	GND	
27	GND	GND	
28	NC		
29	NC		
30	NC		
31	NC		

32	GND	GND
33	GND	GND
34	NC	
35	NC	
36	NC	
37	NC	
38	GND	GND
39	GND	GND
40	NC	
41	NC	
42	GND	GND
43	NC	
44	NC	
45	GND	GND
46	NC	
47	USB_D0-	DIFF
48	GND	GND
49	USB_D0+	DIFF
50	USB_D1-	DIFF
51	GND	GND
52	USB_D1+	DIFF

53	SMB_CLK	I/O	+3.3V
54	GND	GND	
55	SMB_DATA	I/O	+3.3V
56	WAKE#	OUT	+3.3V
57	GND	GND	
58	USB_OC0#	OUT	+3.3V
59	+5V	PWR	+5V
60	USB_OC1#	OUT	+3.3V
61	+5V	PWR	+5V
62	+5V	PWR	+5V
63	+5V	PWR	+5V
64	+5V	PWR	+5V
65	LPC_AD0	I/O	+3.3V
66	LPC_FRAME#	OUT	+3.3V
67	LPC_AD1	I/O	+3.3V
68	SERIRQ	I/O	+3.3V
69	LPC_AD2	I/O	+3.3V
70	LPC_DRQ	OUT	+3.3V
71	LPC_AD3	I/O	+3.3V
72	GPIO0	I/O	+3.3V
73	GND	GND	

74	AGND	GND	
75	LPC_CLK	IN	+3.3V
76	AUD_LINEOUT_L	IN	
77	PME#	OUT	
78	AUD_LINEOUT_R	IN	
79	GND	GND	
80	GND	GND	

Chapter 3

BIOS and Drivers Installation

3.1 BIOS Update

In order for the main board to recognize the BIO daughter board, you will have to update its BIOS so that necessary system configurations can be performed.

Please contact AAEON FAE for the BIOS update, or get more information about the update on <http://www.aaeon.com>

3.2 Drivers Installation

Please follow the steps below to install the drivers for BIO-ST02-C4M1, which can be found in <http://www.aaeon.com/tw/support/download.php>

Step 1 – Install Serial Port Drivers

For Windows XP

1. Open the **patch.exe** file in the folder
2. Follow the instructions
3. Drivers will be installed automatically

For Windows 7 – Method 1:

1. Copy **serial.sys** in Driver CD\Serial Port Driver (Optional)\WIN7_32\win7_X86 to C:\WINDOWS\system32\drivers\
2. Restart your computer

Method 2

1. Change User Account Control settings to **Never notify**

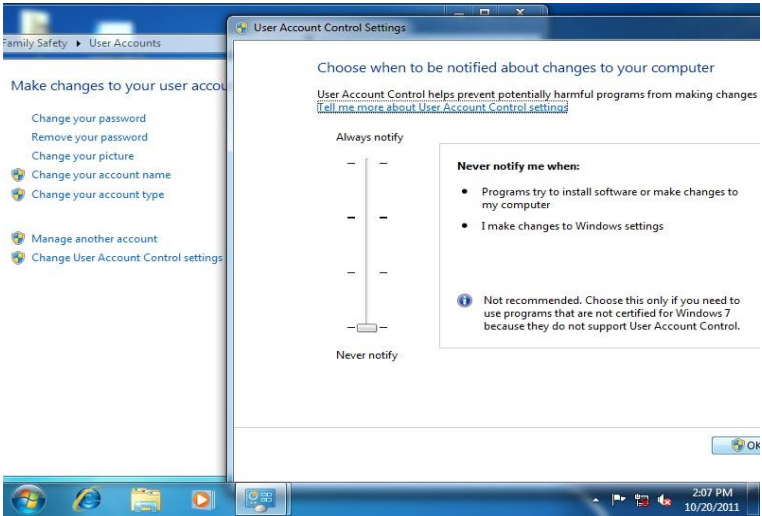

2. Reboot and log in as administrator

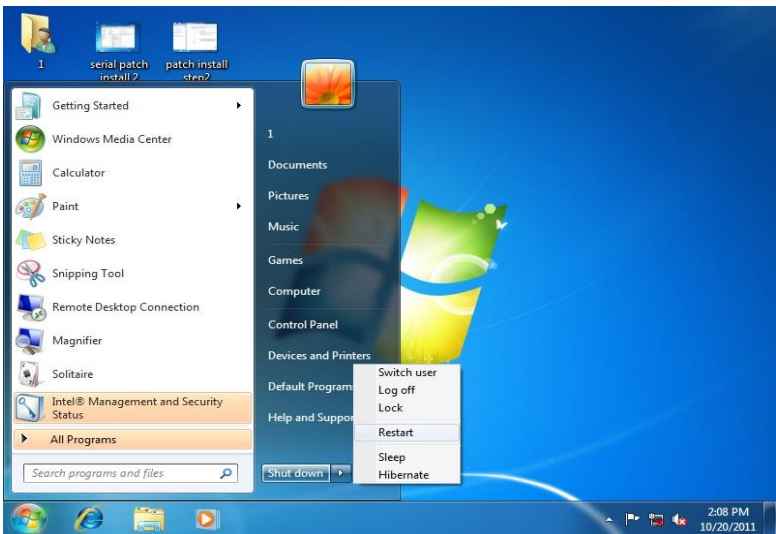

3. Run patch.bat as administrator

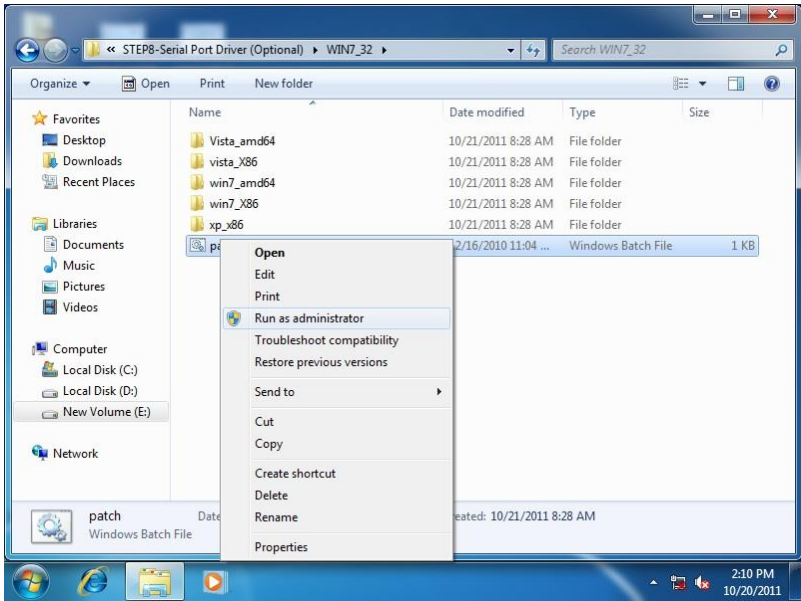

For Windows 8:

1. Open the Apps Screen, right click on the **Command Prompt** tile and select **Run as Administrator**

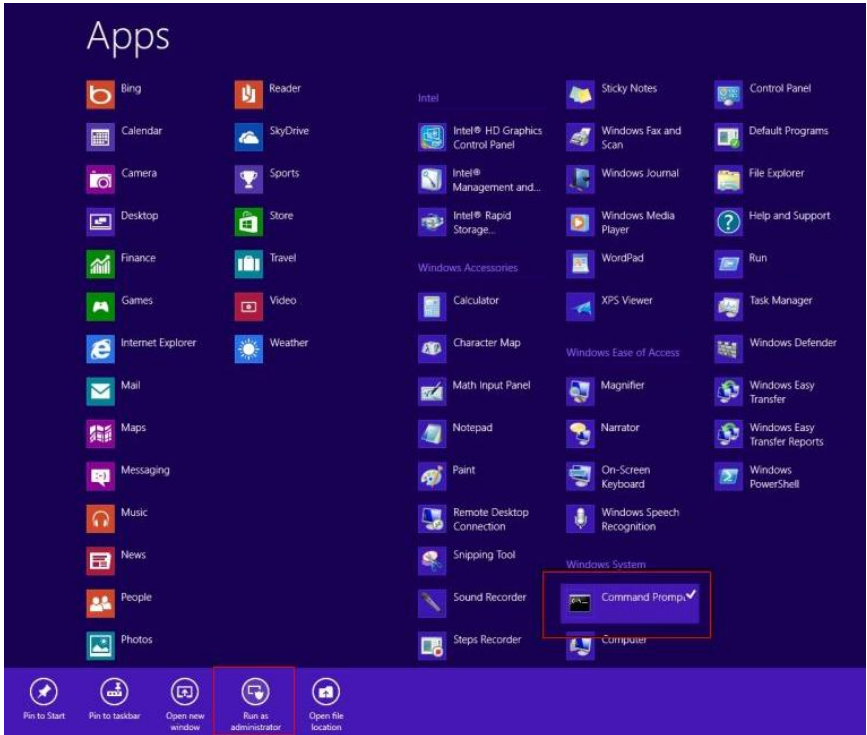

2. To install the driver (patch.bat), you will first have to locate the file in command prompt. To do that, first go to the directory which contains the file by entering **<drive letter>**: eg. if the driver is in D drive, enter **D:**
3. You are now at the directory containing the installation file. Next, go to the messaging in which the file resides by entering **cd <folder>** eg: if the file is in a folder named abc, enter **cd <abc>**.
4. You are now at the folder where the file is located. Enter the **patch.bat** to open and install the drivers. If your file is in a subfolder, enter the **cd**

<folder> command again to access the subfolder (screenshot below is for reference only).

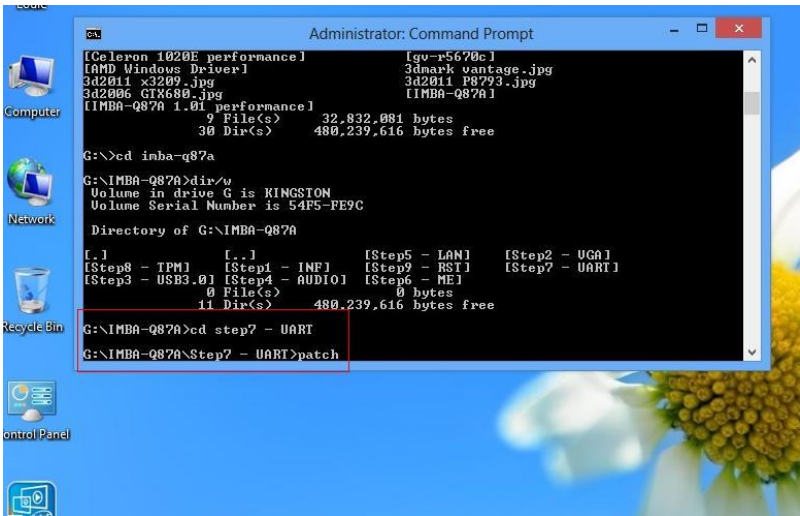

5. Reboot after installation completes.
6. To confirm the installation, go to Device Manager, expand the Ports (COM & LPT) tree and double click on any of the COM ports to open its properties. Go to the Driver tab, select Driver Details and click on **serial.sys**, you should see its provider as **Windows (R) Win 7 DDK Provider**.

