

**APC-9172**

Intel® Core 2 Duo Processor  
Industrial Panel PC  
With 17" TFT LCD &  
Two PCI expansion slots

## Copyright Notice

This document is copyrighted, 2007. All rights are reserved. The original manufacturer reserves the right to make improvements to the products described in this manual at any time without notice.

No part of this manual may be reproduced, copied, translated, or transmitted in any form or by any means without the prior written permission of the original manufacturer. Information provided in this manual is intended to be accurate and reliable. However, the original manufacturer assumes no responsibility for its use, or for any infringements upon the rights of third parties that may result from its use.

The material in this document is for product information only and is subject to change without notice. While reasonable efforts have been made in the preparation of this document to assure its accuracy, AAEON assumes no liabilities resulting from errors or omissions in this document, or from the use of the information contained herein.

AAEON reserves the right to make changes in the product design without notice to its users.

## Acknowledgments

- Intel® and Pentium® are registered trademarks of Intel® Corporation.
- IBM, PC/AT, PS/2 are trademarks of International Business Machines Corporation.
- Microsoft Windows® is a registered trademark of Microsoft Corporation.

**All other product names or trademarks are properties of their respective owners.**

## Packing List

Before you begin operating your PC, please make sure that the following materials have been shipped:

- 1 APC-9172 Robust Panel PC
- 2 Easy stand
- 1 Waterproof sponge
- 12 Panelmount clips & screws
- 1 Screw bag
- 1 CD-ROM for manual (in PDF format) and drivers

If any of these items should be missing or damaged, please contact your distributor or sales representative immediately.

## Safety & Warranty

1. Read these safety instructions carefully.
2. Keep this user's manual for later reference.
3. Disconnect this equipment from any AC outlet before cleaning. Do not use liquid or spray detergents for cleaning. Use a damp cloth.
4. For pluggable equipment, the power outlet must be installed near the equipment and must be easily accessible.
5. Keep this equipment away from humidity.
6. Put this equipment on a firm surface during installation. Dropping it or letting it fall could cause damage.
7. The openings on the enclosure are for air convection. Protect the equipment from overheating. **DO NOT COVER THE OPENINGS.**
8. Make sure the voltage of the power source is correct before connecting the equipment to the power outlet.
9. Position the power cord so that people cannot step on it. Do not place anything over the power cord.
10. All cautions and warnings on the equipment should be noted.
11. If the equipment is not used for a long time, disconnect it from the power source to avoid damage by transient over-voltage.
12. Never pour any liquid into an opening. This could cause fire or electrical shock.
13. Never open the equipment. For safety reasons, only qualified service personnel should open the equipment.
14. If any of the following situations arises, get the equipment checked by service personnel:
  - a. The power cord or plug is damaged.
  - b. Liquid has penetrated into the equipment.
  - c. The equipment has been exposed to moisture.

- d. The equipment does not work well, or you cannot get it to work according to the user's manual.
  - e. The equipment has been dropped and damaged.
  - f. The equipment has obvious signs of breakage.
15. DO NOT LEAVE THIS EQUIPMENT IN AN ENVIRONMENT WHERE THE STORAGE TEMPERATURE IS BELOW -20°C (-4°F) OR ABOVE 60°C (140°F). IT MAY DAMAGE THE EQUIPMENT.
16. External equipment intended for connection to signal input/output or other connectors, shall comply with relevant UL / IEC standard (e.g. UL 60950 for IT equipment and UL 2601-1 / IEC 60601 series for medical electrical equipment). In addition, all such combinations – systems – shall comply with the standard IEC 60601-1-1, Safety requirements for medical electrical systems. Equipment not complying with UL 2601-1 shall be kept outside the patient environment, as defined in the standard.

## FCC Safety

***Warning!***



This device complies with Part 15 FCC Rules. Operation is subject to the following two conditions: (1) this device may not cause harmful interference, and (2) this device must accept any interference received including interference that may cause undesired operation.

## Below Table for China RoHS Requirements

产品中有毒有害物质或元素名称及含量

## AAEON Panel PC/ Workstation

部件名称	有毒有害物质或元素					
	铅 (Pb)	汞 (Hg)	镉 (Cd)	六价铬 (Cr(VI))	多溴联苯 (PBB)	多溴二苯醚 (PBDE)
印刷电路板 及其电子组件	×	○	○	○	○	○
外部信号 连接器及线材	×	○	○	○	○	○
外壳	×	○	○	○	○	○
中央处理器 与内存	×	○	○	○	○	○
硬盘	×	○	○	○	○	○
液晶模块	×	○	○	○	○	○
光驱	×	○	○	○	○	○
触控模块	×	○	○	○	○	○
电源	×	○	○	○	○	○

**O:** 表示该有毒有害物质在该部件所有均质材料中的含量均在  
SJ/T 11363-2006 标准规定的限量要求以下。

**X:** 表示该有毒有害物质至少在该部件的某一均质材料中的含量超出  
SJ/T 11363-2006 标准规定的限量要求。

备注:

- 一、此产品所标示之环保使用期限，系指在一般正常使用状况下。
- 二、上述部件物质中央处理器、内存、硬盘、光驱、触控模块为选购品。

# Contents

## Chapter 1 General Information

1.1 Introduction.....	1-2
1.2 Features .....	1-3
1.3 Specifications .....	1-4
1.4 Dimension .....	1-7

## Chapter 2 Hardware Installation

2.1 Safety Precautions .....	2-2
2.2 COM1-4 RS-232/422/485 Serial Port Connector (CN16) .....	2-3
2.3 HDD Installation .....	2-4
2.4 CD-ROM Installation .....	2-6
2.5 Easy Stand Installation.....	2-7
2.6 Panel Mount Kit Installation.....	2-8
2.7 Waterproof sponge Installation .....	2-9

## Chapter 3 BIOS Installation

3.1 System Test and Initialization. ....	3-2
3.2 Award BIOS Setup .....	3-3

## Chapter 4 Driver Installation

4.1 Installation .....	4-3
4.2 Limitations .....	4-4



**Appendix A I/O Information**

A.1 I/O Address Map .....A-2  
A.2 Memory Address Map .....A-3  
A.3 IRQ Mapping Chart .....A-4  
A.4 DMA Channel Assignments .....A-4

Chapter

1

**General  
Information**

## 1.1 Introduction

---

APC-9172 is first Core 2 Duo industrial board in AAEON Panel PC product line. It features a PGA478 socket that can accommodate Core 2 Duo Processor, supporting FSB up to 400/533/667MHz.

### **Best performance for multimedia solution**

AAEON's APC-9172 also supports DDR DRAM up to 2GB. It can provide the strong multimedia functions. Therefore APC-9172 can be broadly implemented in several markets, such as Point of sale, point of information (Kiosk), and gaming markets.

### **Multi-Function Core 2 Duo Platform**

If you are looking for powerful multi-media applications,

APC-9172 is the one. APC-9172 integrates 17" color TFT LCD, Audio and Ethernet function; meanwhile it also supports 5 USB2.0, mini PCI, and two PCI slots. With flexible expansion, you get easy access to solutions ranging from Modem, Storage, Sound Card, SCSI card, Audio/Video capture card, Wireless LAN module, to Bluetooth module. Especially for customers whom application is various or changing, APC-9172 reserves more than enough flexibility for future expansion.

APC-9172 provides more CPU options for different applications. You can choose Core 2 Duo processor up to 2.0G for high performance application.

## 1.2 Features

---

- 17" TFT SXGA (1280 x 1024) LCD
- All-in-one SBC supports Socket 478 based Intel® Core 2 Duo Processor
- Anti-vibration disk drive bay for HDD
- Water-proof and anti-scratch IP-65 certified aluminum front panel with USB port certification
- Two free PCI expansion slots
- Resistive TouchScreen (optional)

### 1.3 Specifications

---

#### System

- Construction Heavy-duty steel chassis & IP-65 certified aluminum front panel (or optional stainless steel front panel)
- CPU Socket 478 based Intel® Core 2 Duo Processor up to 2.0G with FSB 400/533/667MHz
- LCD/CRT Intel® 945GM, AGP 4X Controller
- System Memory DDRII SODIMM Socket x 1 up to 2G
- OS Support Windows® 2000, Windows® XP, Windows® XP Embedded (Optional)
- Storage Disk Drive Anti-vibration 2.5" HDD, Slim FDD and Slim CD-ROM
- I/O Chipset 2 Serial ports: 2 x RS-232, 1 x RS-232/422/485 (COM 4 is reserved for touch screen);  
1 parallel port (supports ECP/EPP);  
1 PS/2 mouse and keyboard port;  
1 VGA port Mic-in, Line-in, Line-out
- Ethernet Intel® 85573L, 10/100/1000Base-TX, 2 x Gigabit LAN ports
- Expansion slots 2 PCI slots, 1 Mini PCI socket, 6-in-1 card reader, supports CompactFlash®

(Type I/II), Secure Digital, Multi Media Card, Memory Stick (PRO) and Smart Media

- USB ports 4 USB 2.0 ports on rear panel;  
1 USB 2.0 port on front panel (Lockable by BIOS) Because of USB chipset limitation, front USB port and Card reader USB interface are linked together, when user “disable” front USB port ( USB Port 3 controller ) , the card reader must be forced to disable at the same time
- Power Supply Universal 250W switching power supply

### **Mechanical and Environment**

- Front Panel PMS 2965C (Dark Blue)
- Mounting Panelmount, VESA 75/100mm holes
- Dimension 19" x 15.7" x 5.7"  
(483mm x 399mm x 145mm)
- Carton Dimension 24.4" x 20.6" x 13.8"  
(620mm x 522mm x 351mm)
- Gross Weight 15 Kg (33 lb)
- Operating temperature 32°F~122°F (0°C ~50°C)
- Storage temperature -4°F~140°F (-20°C~60°C)

- Operating humidity 10 to 90% @35°C, non-condensin
- Vibration 1.5G / 5~500Hz (Random/ operation)
- Shock 15G peak acceleration (11 msec. duration)/ operation
- EMC CE/FCC Class A

### **Power Supply**

- AC input 250W:  
Output rating: 250W  
  
Input voltage: 100VAC~240VAC@47~63Hz  
  
Output voltage: +3.3V@16A, +5V@25A, +12V@13A,  
+5VSB@2A, -5V@0.3A, -12V@0.8A

### **LCD Specifications**

- Display type 17" color TFT LCD
- Max. Resolution 1280 x 1024
- Max. Colors 16.2M
- Dot size (mm) 0.264 x 0.264
- Luminance (cd/m<sup>2</sup>) 260 (TYP)
- Viewing angle 140°(H)  
130°(V)
- Back Light MTB 50,000 (hrs)

**TouchScreen (Optional)**

- Type 8-wire, analog resistive
- Resolution 2048 x 2048
- Light transmission >80%
- Lifetime 10 million activations
- OS support Windows 2000, Windows XP, Windows XP Embedded

**1.4 Dimension**

Unit : mm

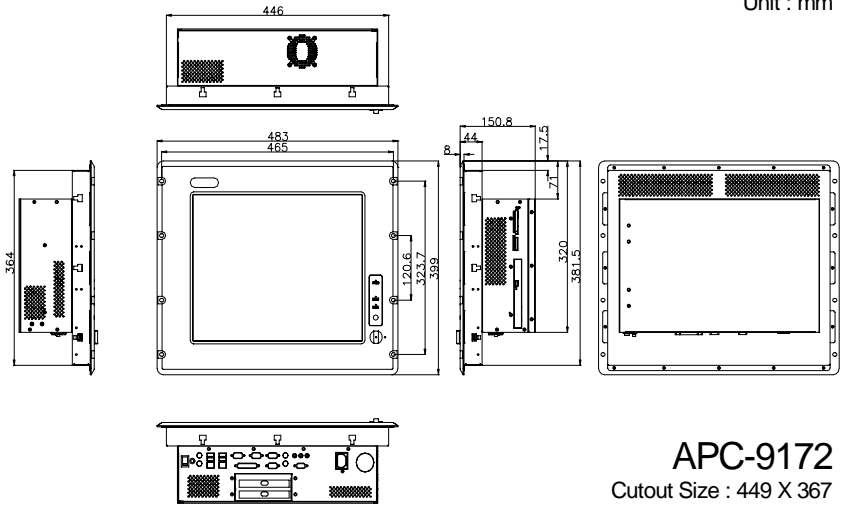

**APC-9172**  
Cutout Size : 449 X 367



**Chapter**

**2**

**Hardware  
Installation**

## 2.1 Safety Precautions

---

### **Warning!**



*Always completely disconnect the power cord from your board whenever you are working on it. Do not make connections while the power is on, because a sudden rush of power can damage sensitive electronic components.*

### **Caution!**



*Always ground yourself to remove any static charge before touching the board. Modern electronic devices are very sensitive to static electric charges. Use a grounding wrist strap at all times. Place all electronic components on a static-dissipative surface or in a static-shielded bag when they are not in the chassis*

## 2.2 COM1~4 RS-232/422/485 Serial Port Connector (CN16)

---

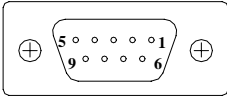

COM 4 is reserved for touch screen.

Pin	Signal	Pin	Signal
1	DCD1	2	DSR1
3	RXD1	4	RTS1
5	TXD1	6	CTS1
7	DTR1	8	RI1
9	GND		

### 2.3 HDD Installation

---

Step 1: Screw up the HDD onto HDD Bracket

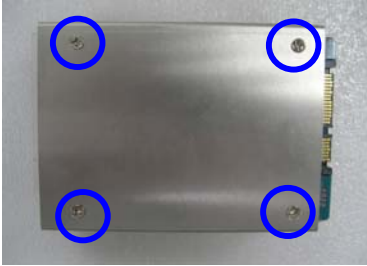

Step 2: Fasten the 4 pieces of anti-vibration Rubbers on the HDD bracket.

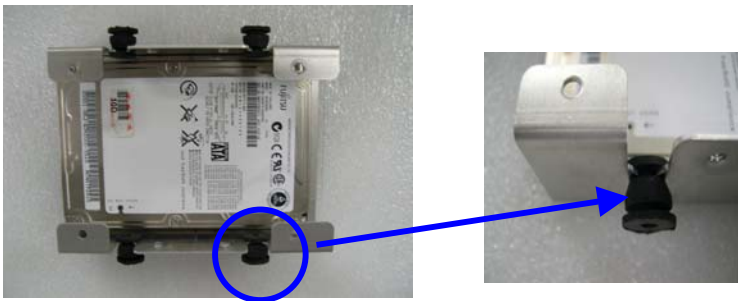

Step 3: Screw two brackets with four screws to fasten Anti-vibration Rubbers.

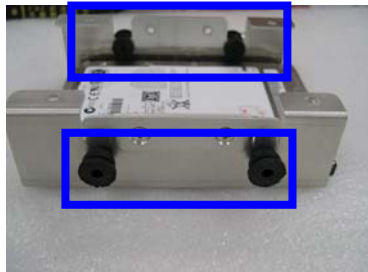

Step 4: Put the rubbers into indentations to fix the whole HDD brackets with HDD on HDD box

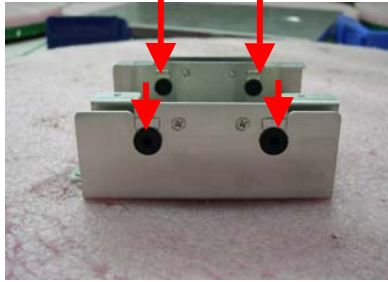

Step 5: Fix HDD box on the units with three screws



Step 6: Plug into HDD cable and you've done HDD installation



## 2.4 CD-ROM Installation

---

Step 1: Fasten the CD-ROM on brackets

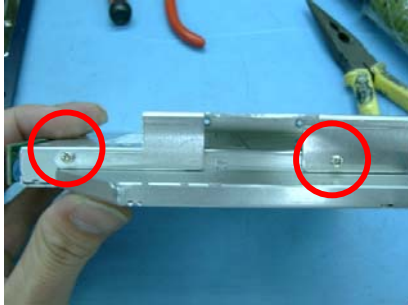

Step 2: Fasten the transferring bar with a pair screws on the back of CD-ROM



Step 3: Fasten the CD-ROM module on the on the chassis and plug the cable

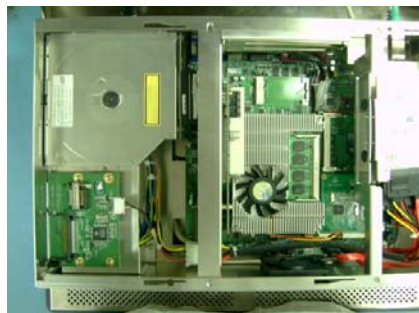

## 2.5 Easy Stand Installation

---

There're two L-shaped easy stands come with the product. Refer to the following illustration to install it.

1. Fix the L-shaped easy stands with the screws on both sides of the monitor. See the illustration below:

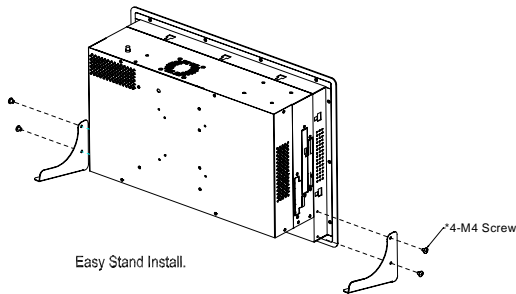

## 2.6 Panelmount Kit Installation

---

Some screw sets will come with the product for user to mount the monitor on the wall. See the steps below along with the illustration.

Step 1: Bore the screw into the screw nut.

Step 2: Locate the screw set into the hole around the monitor as the right illustration and pull it back to lock the screw set on the hole.

Step 3: Turn the screw around to make it tight until it is closed to the wall.

Step 4: Lock the monitor to the wall with the screw set which mean you've done a good job.

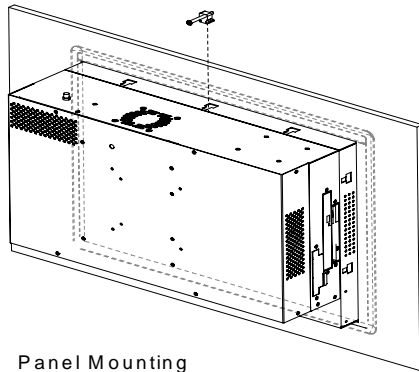
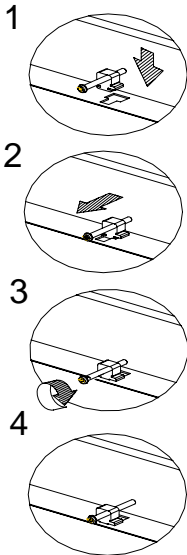



## 2.7 Waterproof Sponge Installation

---

The following illustration shows you how to lodge the waterproof sponge in the back of the monitor set.

1. Lodge the Sponge in the back of the monitor set.
2. Locate the monitor set on the wall.

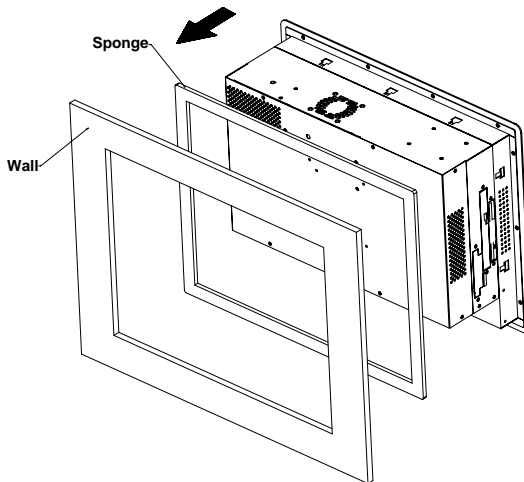

Chapter

3

# BIOS Installation

### 3.1 System test and initialization

---

These routines test and initialize board hardware. If the routines encounter an error during the tests, you will either hear a few short beeps or see an error message on the screen. There are two kinds of errors: fatal and non-fatal. The system can usually continue the boot up sequence with non-fatal errors. Non-fatal error messages usually appear on the screen along with the following instructions:

Press <F1> to RESUME

Write down the message and press the F1 key to continue the boot up sequence.

### System configuration verification

These routines check the current system configuration against the values stored in the CMOS memory. If they do not match, the program outputs an error message. You will then need to run the BIOS setup program to set the configuration information in memory.

There are three situations in which you will need to change the CMOS settings:

1. You are starting your system for the first time

You have changed the hardware attached to your system

The CMOS memory has lost power and the configuration information has been erased.

The APC-9172 CMOS memory has an integral lithium battery backup for data retention. However, you will need to replace the complete unit when it finally runs down.

## 3.2 Award BIOS Setup

---

Awards BIOS ROM has a built-in Setup program that allows users to modify the basic system configuration. This type of information is stored in battery-backed CMOS RAM so that it retains the Setup information when the power is turned off.

### Entering Setup

Power on the computer and press <Del> immediately. This will allow you to enter Setup.

### Standard CMOS Features

Use this menu for basic system configuration. (Date, time, IDE, etc.)

### Advanced BIOS Features

Use this menu to set the advanced features available on your system.

### Advanced Chipset Features

Use this menu to change the values in the chipset registers and optimize your system performance.

### Integrated Peripherals

Use this menu to specify your settings for integrated peripherals. (Primary slave, secondary slave, keyboard, mouse etc.)

### Power Management Setup

Use this menu to specify your settings for power management. (HDD power down, power on by ring, KB wake up, etc.)

### PnP/PCI Configurations

This entry appears if your system supports PnP/PCI.

### PC Health Status

This menu allows you to set the shutdown temperature for your

system.

### **Frequency/Voltage Control**

Use this menu to specify your settings for auto detect DIMM/PCI clock and spread spectrum.

### **Load Fail-Safe Defaults**

Use this menu to load the BIOS default values for the minimal/stable performance for your system to operate.

### **Load Optimized Defaults**

Use this menu to load the BIOS default values that are factory settings for optimal performance system operations. While AWARD has designated the custom BIOS to maximize performance, the factory has the right to change these defaults to meet their needs.

### **Set Supervisor/User Password**

Use this menu to set Supervisor/User Passwords.

### **Save and Exit Setup**

Save CMOS value changes to CMOS and exit setup.

### **Exit Without Saving**

Abandon all CMOS value changes and exit setup.

**You can refer to the "AAEON BIOS Item Description.pdf" file in the CD for the meaning of each setting in this chapter.**

### **Limitation:**

1. Due to Intel chipset limitation, when CMOS was set up to "LCD + CRT", the LCD display will not support full-screen appearance.
2. Because of USB chipset limitation, front USB port and Card reader USB interface are linked together, when user "disable" front USB port (USB Port 3 controller), the card reader must be forced to disable at same time.

**Chapter**

**4**

**Driver  
Installation**

There are several installation ways depending on the driver package under different Operating System application. The Autorun program will run automatically. However, if the Autorun program cannot be run smoothly, please follow the sequence below to install the drivers:

- Step 1– INF Driver Installation
- Step 2– VGA Driver Installation
- Step 3– Intel LAN Driver Installation
- Step 4– Audio Driver Installation
- Step 5– Card Reader Driver Installation
- Step 6– Touch Screen Driver Installation

USB 2.0 Drivers are available for download using Windows Update for both Windows XP and Windows 2000. For additional information regarding USB 2.0 support in Windows XP and Windows 2000, please visit [www.microsoft.com/hwdev/usb/](http://www.microsoft.com/hwdev/usb/).

For installation procedures of each driver, you may see the details in the following.

## 4.1 Installation

---

Insert the APC-9172 CD-ROM into the CD-ROM drive and install the drivers from Step 1 to Step 6 in order.

### Step 1 – Install INF Driver

1. Click on the **Step 1-INF** folder
2. Double click on ***infinst\_autol.exe***
3. Follow the instructions that the window shows
4. The system will help you install the driver automatically

### Step 2 – Install VGA Driver

1. Click on the **Step 2 –VGA** folder
2. Double click on ***win2k\_xp1425.exe***
3. Follow the instructions that the window shows
4. The system will help you install the driver automatically

### Step 3 – Install Intel LAN Driver

1. Click on the **Step 3 –Intel\_LAN** folder
2. Double click on ***PRO2KXP.exe***
3. Follow the instructions that the window shows
4. The system will help you install the driver automatically

### Step 4 – Install Audio Driver

1. Click on the **Step 4 –AUDIO** folder



2. Double click on **WDM\_A395.exe**
3. Follow the instructions that the window shows
4. The system will help you install the driver automatically

#### Step 5 – Install Card Reader Driver

1. Click on the **Step 5 –Card\_Reader** folder
2. Double click on **Setup.exe**
3. Follow the instructions that the window shows
4. The system will help you install the driver automatically

#### Step 6 – Install Touch Screen Driver

1. Click on the **Step 6 –TOUCH** folder
2. Double click on **Setup.exe**
3. Follow the instructions that the window shows
4. The system will help you install the driver automatically

## 4.2 Limitations

---

1. The limitations you may need to notice when you start to install the driver. For the sake of USB4 and USB5 community of linkage, the card reader must be forced to disable when the users “disable” front USB port.
2. If the length of the LAN cable connected to LAN 2 is over 35 meters, it may result in more than 10 times of time-out errors during network transmission. We strongly recommend you to use LAN 1 for this application.

Appendix



































A

# I/O Information

## A.1 I/O Address Map

Input/output (IO)	
[00000000 - 0000000F]	Direct memory access controller
[00000000 - 000000CF7]	PCI bus
[00000010 - 0000001F]	Motherboard resources
[00000020 - 00000021]	Programmable interrupt controller
[00000022 - 0000003F]	Motherboard resources
[00000040 - 00000043]	System timer
[00000044 - 0000005F]	Motherboard resources
[00000060 - 00000060]	Standard 101/102-Key or Microsoft Natural PS/2 Keyboard
[00000061 - 00000061]	System speaker
[00000062 - 00000063]	Motherboard resources
[00000064 - 00000064]	Standard 101/102-Key or Microsoft Natural PS/2 Keyboard
[00000065 - 0000006F]	Motherboard resources
[00000070 - 00000073]	System CMOS/real time clock
[00000074 - 0000007F]	Motherboard resources
[00000080 - 00000090]	Direct memory access controller
[00000091 - 00000093]	Motherboard resources
[00000094 - 0000009F]	Direct memory access controller
[000000A0 - 000000A1]	Programmable interrupt controller
[000000A2 - 000000BF]	Motherboard resources
[000000C0 - 000000DF]	Direct memory access controller
[000000E0 - 000000EF]	Motherboard resources
[000000F0 - 000000FF]	Numeric data processor
[000001F0 - 000001F7]	Primary IDE Channel
[00000274 - 00000277]	ISAPNP Read Data Port
[00000279 - 00000279]	ISAPNP Read Data Port
[00000290 - 0000029F]	Motherboard resources
[000002E8 - 000002EF]	Communications Port (COM4)
[000002F8 - 000002FF]	Communications Port (COM2)
[00000378 - 0000037F]	Printer Port (LPT1)
[000003B0 - 000003BB]	Mobile Intel(R) 945GM Express Chipset Family
[000003C0 - 000003DF]	Mobile Intel(R) 945GM Express Chipset Family
[000003E8 - 000003EF]	Communications Port (COM3)
[000003F0 - 000003F5]	Standard floppy disk controller
[000003F6 - 000003F6]	Primary IDE Channel
[000003F7 - 000003F7]	Standard floppy disk controller
[000003F8 - 000003FF]	Communications Port (COM1)
[00000400 - 000004BF]	Motherboard resources
[000004D0 - 000004D1]	Motherboard resources
[00000500 - 0000051F]	Intel(R) 82801G (ICH7 Family) SMBus Controller - 27DA
[00000800 - 0000087F]	Motherboard resources
[00000A79 - 00000A79]	ISAPNP Read Data Port
[00000D00 - 0000FFFF]	PCI bus
[00009000 - 00009FFF]	Intel(R) 82801G (ICH7 Family) PCI Express Root Port - 27D0
[0000B000 - 0000BFFF]	Intel(R) 82801G (ICH7 Family) PCI Express Root Port - 27D6
[0000C000 - 0000CFFF]	Intel(R) 82801G (ICH7 Family) PCI Express Root Port - 27D4
[0000D000 - 0000DFFF]	Intel(R) 82801G (ICH7 Family) PCI Express Root Port - 27D2
[0000DF00 - 0000FFFF]	Marvell Yukon 88E8053 PCI-E Gigabit Ethernet Controller
[0000F000 - 0000F0FF]	Realtek AC'97 Audio
[0000F300 - 0000F30F]	Intel(R) 82801GBM/GHM (ICH7-M Family) Serial ATA Storage Controller - 27C4
[0000F400 - 0000F403]	Intel(R) 82801GBM/GHM (ICH7-M Family) Serial ATA Storage Controller - 27C4
[0000F500 - 0000F507]	Intel(R) 82801GBM/GHM (ICH7-M Family) Serial ATA Storage Controller - 27C4
[0000F600 - 0000F603]	Intel(R) 82801GBM/GHM (ICH7-M Family) Serial ATA Storage Controller - 27C4
[0000F700 - 0000F707]	Intel(R) 82801GBM/GHM (ICH7-M Family) Serial ATA Storage Controller - 27C4
[0000F800 - 0000F80F]	Intel(R) 82801G (ICH7 Family) Ultra ATA Storage Controllers - 27DF
[0000FA00 - 0000FA3F]	Realtek AC'97 Audio
[0000FB00 - 0000FB1F]	Intel(R) 82801G (ICH7 Family) USB Universal Host Controller - 27CB
[0000FC00 - 0000FC1F]	Intel(R) 82801G (ICH7 Family) USB Universal Host Controller - 27CA
[0000FD00 - 0000FD1F]	Intel(R) 82801G (ICH7 Family) USB Universal Host Controller - 27C9
[0000FE00 - 0000FE1F]	Intel(R) 82801G (ICH7 Family) USB Universal Host Controller - 27C8
[0000FF00 - 0000FF07]	Mobile Intel(R) 945GM Express Chipset Family
+	Interrupt request (IRQ)
+	Memory

## A.2 Memory Address Map

		Input/output (IO)
		Interrupt request (IRQ)
		Memory
	[00000000 - 0009FFFF]	System board
	[000A0000 - 000BFFFF]	Mobile Intel(R) 945GM Express Chipset Family
	[000A0000 - 000BFFFF]	PCI bus
	[000C0000 - 000DFFFF]	PCI bus
	[000CE600 - 000CFFFF]	System board
	[000E0000 - 000EFFFF]	System board
	[000F0000 - 000F7FFF]	System board
	[000F8000 - 000FBFFF]	System board
	[000FC000 - 000FFFFF]	System board
	[00100000 - 0F6DFFFF]	System board
	[0F6E0000 - 0F6FFFFF]	System board
	[0F700000 - FEBFFFFF]	PCI bus
	[D0000000 - DFFFFFFF]	Mobile Intel(R) 945GM Express Chipset Family
	[E0000000 - EFFFFFFF]	Motherboard resources
	[FD500000 - FDSFFFFF]	Intel(R) 82801G (ICH7 Family) PCI Express Root Port - 27D2
	[FD600000 - FD6FFFFF]	Intel(R) 82801G (ICH7 Family) PCI Express Root Port - 27D2
	[FD6FC000 - FD6FFFFF]	Marvell Yukon 88E8053 PCI-E Gigabit Ethernet Controller
	[FD700000 - FD7FFFFF]	Intel(R) 82801G (ICH7 Family) PCI Express Root Port - 27D0
	[FDA00000 - FDAFFFFF]	Intel(R) 82801G (ICH7 Family) PCI Express Root Port - 27D0
	[FDB00000 - FDBFFFFF]	Intel(R) 82801G (ICH7 Family) PCI Express Root Port - 27D6
	[FDC00000 - FDCFFFFF]	Intel(R) 82801G (ICH7 Family) PCI Express Root Port - 27D6
	[FDD00000 - FDDFFFFF]	Intel(R) 82801G (ICH7 Family) PCI Express Root Port - 27D4
	[FDE00000 - FDEFFFFF]	Intel(R) 82801G (ICH7 Family) PCI Express Root Port - 27D4
	[FDF00000 - FDF7FFFF]	Mobile Intel(R) 945GM Express Chipset Family
	[FDF80000 - FDFBFFFF]	Mobile Intel(R) 945GM Express Chipset Family
	[FDFFC000 - FDFFC3FF]	Intel(R) 82801GBM/GHM (ICH7-M Family) Serial ATA Storage Controller - 27C4
	[FDFFD000 - FDFFD0FF]	Realtek AC'97 Audio
	[FDFFE000 - FDFFE1FF]	Realtek AC'97 Audio
	[FDFFF000 - FDFFF3FF]	Intel(R) 82801G (ICH7 Family) USB2 Enhanced Host Controller - 27CC

### A.3 IRQ Mapping Chart

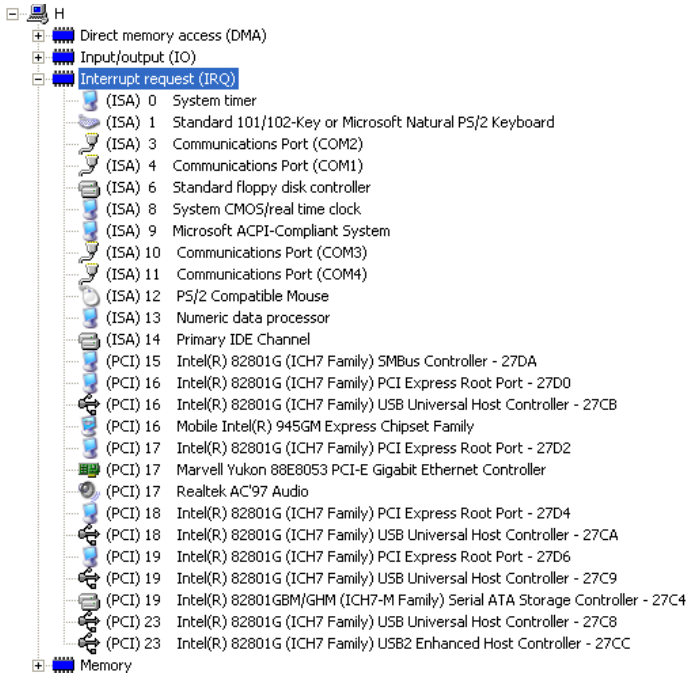

### A.4 DMA Channel Assignments

