

**AMB-2023-E / 2053-E**  
Open Frame Industrial  
Panel PC

## Copyright Notice

---

This document is copyrighted, 2002. All rights are reserved. The original manufacturer reserves the right to make improvements to the products described in this manual at any time without notice.

No part of this manual may be reproduced, copied, translated, or transmitted in any form or by any means without the prior written permission of the original manufacturer. Information provided in this manual is intended to be accurate and reliable. However, the original manufacturer assumes no responsibility for its use, nor for any infringements upon the rights of third parties, which may result from its use.

The material in this document is for product information only and is subject to change without notice. While reasonable efforts have been made in the preparation of this document to assure its accuracy, AAEON, assumes no liabilities resulting from errors or omissions in this document, or from the use of the information contained herein.

AAEON reserves the right to make changes in the product design without notice to its users.

## Acknowledgments

---

AMD is a trademark of Advanced Micro Devices, Inc.

AMI is a trademark of American Megatrends, Inc.

Award is a registered trademark of Award Software International, Inc.

Cyrix is a trademark of Cyrix Corporation.

IBM, PC/AT, PS/2 are trademarks of International Business Machines Corporation.

Intel and Pentium are registered trademarks of Intel® Corporation.

Microsoft Windows is a registered trademark of Microsoft Corporation.

SMC is a trademark of Standard Microsystems Corporation.

RTL is a trademark of Realtek Semi-Conductor Co., Ltd.

C&T is a trademark of Chips and Technologies, Inc.

UMC is a trademark of United Microelectronics Corporation.

ITE is a trademark of Integrated Technology Express, Inc.

SiS is a trademark of Silicon Integrated Systems Corp.

VIA is a trademark of VIA Technology, Inc.

All other product names or trademarks are properties of their respective owners.

## Packing List

---

Then you should also check if the package contains the following items. You should contact your dealer immediately if any of these items are missing or damaged

- AMB-2023-E/ AMB-2053-E series Panel PC
- CD-ROM  
For User' s Manual, Drivers and Utilities
- Accessory,
  - Metal cover for LCD connector
  - Y-shaped adapter for PS/2 mouse and keyboard
  - Power cable for HDD
  - 50-pin SCSI Cable (1M)
  - Mounting kits
  - Touch Pen (optional)
  - CPU Cooling fan
  - Screws bag
  - Waterproof sponge
  - Power cord (1.8 M)

With the touchscreen option

- Touch pen

If any of their items are missing or damaged, contact your distributor or sales representative immediately.

## Safety & Warranty

---

1. Read these safety instructions carefully.
2. Keep this user's manual for later reference.
3. Disconnect this equipment from any AC outlet before cleaning. Do not use liquid or spray detergents for cleaning. Use a damp cloth.
4. For pluggable equipment, the power outlet must be installed near the equipment and must be easily accessible.
5. Keep this equipment away from humidity.
6. Put this equipment on a reliable surface during installation. Dropping it or letting it fall could cause damage.
7. The openings on the enclosure are for air convection. Protect the equipment from overheating. **DO NOT COVER THE OPENINGS.**
8. Make sure the voltage of the power source is correct before connecting the equipment to the power outlet.
9. Position the power cord so that people cannot step on it. Do not place anything over the power cord.
10. All cautions and warnings on the equipment should be noted.
11. If the equipment is not used for a long time, disconnect it from the power source to avoid damage by transient over-voltage.
12. Never pour any liquid into an opening. This could cause fire or electrical shock.
13. Never open the equipment. For safety reasons, only qualified service personnel should open the equipment.
14. If any of the following situations arises, get the equipment checked by service personnel:
  - a. The power cord or plug is damaged.
  - b. Liquid has penetrated into the equipment.
  - c. The equipment has been exposed to moisture.
  - d. The equipment does not work well, or you cannot get it to work according to the users manual.
  - e. The equipment has been dropped and damaged.
  - f. The equipment has obvious signs of breakage.

15. DO NOT LEAVE THIS EQUIPMENT IN AN UNCONTROLLED ENVIRONMENT WHERE THE STORAGE TEMPERATURE IS BELOW -20° C (-4° F) OR ABOVE 60° C (140° F). IT MAY DAMAGE THE EQUIPMENT.

*Caution:*

*Danger of explosion if battery is incorrectly replaced. Replace only with the same or equivalent type recommended by the manufacturer. Dispose of used batteries according to the manufacturer's instructions.*

These products are with CE and FCC certification. UL certification for AMB-2023 series and AMB-2053 series only.

Chapter

1

**General  
Information**

## **Introduction**

---

The AMB-2023/2053 series modular system panel PCs, is the PC-base industrial computer that specially designed to keep normal operation under harsh environment, which meet the entire requirement as an industrial human machine interface (HMI).

They provide a complete hard ware application and construct a high quality aluminum front panel IP65 which meets the toughest industrial and environmental protection standards

It is a full-function PC-base system with a 12.1" SVGA (800 x 600), 15" XGA (1024 x 768) color TFT hi-brightness, long-life time LCD display, and compact with different control modules via a 50-pin SCSI cable. The compact dimensions are ideal for automation applications when the installation space is critical.

These PCs are characterized by their space saving, there are two free slots for PCI/ ISA. AMB-2023/2053 is heavy-duty steel chassis with an aluminum front panel meets the toughest industrial and environmental standards. All the controls and connectors are placed on the rear panel; you can connect the panel PCs to other devices via them.



## Features

---

**AMB-2023-E (12.1" open frame LCD + ACS-2303 Control Box)**

**AMB-2053-E (15" open frame LCD + ACS-2303 Control Box)**

- 12.1" SVGA/15" XGA color TFT LCD display
- Open frame architecture with heavy-duty steel chassis
- Front panel with frame has certified IP65
- Supports Socket 370 CPU up to Pentium® III 850MHz
- Adjustment-panel on the rear panel
- Two 16C550 RS-232C port
- Disk Driver Space for CD-ROM, FDD and HDD
- DiskOnChip flash disk socket
- Two free expansion slots for ISA or PCI
- Resistive Touch Screen (optional)

### Features of SBC-658 Single Board Computer

- Supports Intel Celeron /Pentium III FC-370
- Supports DiskOnChip (SSD) up to 288MB
- C&T 69000 LCD controller supports 36-bit TFT Panels
- 10/100Base-T Fast Ethernet
- Supports H/W status monitoring

## Specifications

---

- **Construction:** Heavy-duty steel chassis & open frame front panel.
- **CPU:** Supports Socket 370 based Intel Pentium III and Celeron CPU; up to Pentium III 850MHz (FSB 66/ 100MHz)
- **Memory:** Supports up to 256MB
- **Display:** 12.1" SVGA / 15" XGA (1024 x 768) color TFT LCD
- **LCD/CRT controller:**  
C&T 69000 VGA controller with 2MB embedded SDRAM. CRT & LCD panel support
- **Network (LAN):** Intel 82559ER 10/100 Base-T Ethernet controller
- **I/O ports:**  
2 serial ports: 1 x RS-232, 1 x RS-232/422/485  
(one is reserved for touchscreen)  
1 parallel port (supports ECP/EPP)  
1 PS/2 mouse and keyboard interface
- **Disk Drive Housing:**  
3.5" HDD or  
2.5" HDD, Slim FDD and Slim CD-ROM  
(2 types of housing both are not compatible)
- **USB connector:** Pin header for Dual USB with USB bracket cable
- **Mounting:** Panel and Rear mount
- **Expansion slots:** 2 PCI or 1 ISA and 1 PCI slot
- **Power supply:** Universal 70W switching power supply

## Power Supply Selection Table

Mode	Input voltage	Max. Output Current		
		+5V	+12V	-12V
Universal/70W	85-265VAC	12A	2.5A	0.3A
24VDC/70W	10-30VDC	12A	2.5A	0.3A

## LCD Specifications

Model	AMB-2023	AMB-2053
Display type	12.1" color TFT LCD	15" color TFT LCD
Max. Resolution	800 x 600	1024 x 768
Max. Colors	256K	256K
Dot size (mm)	0.3075 x 0.3075	0.313 x 0.329
Luminance (cd/m <sup>2</sup> )	250	250
Viewing angle	120 ° (H)	160 ° (H)
	90 ° (V)	160 ° (V)
Temperature	0 ° ~ 50 (32~122 )	0 ° ~ 50 (32~122 )
LCD MTBF (Hrs)	50,000	50,000
Back Light MTBF (Hrs)	50,000	50,000

## Environmental Specifications

- **Operating temperature:** 0° to 45° (32~113 )
- **Operating humidity:** 5 to 95%, non-condensing
- **Vibration:**  
Random Non-operation 2G 5-500Hz
- **Shock:** 15G-peak acceleration (11-msec. duration)
- **EMC:** CE/FCC Class A
- **Safety:** UL

## Touchscreen (Optional)

- **Type:** 8-wire, analog resistive
- **Resolution:** 1024 x 1024
- **Light transmission:** >75% (AMB-2023), >68% (AMB-2053)
- **Operating pressure:** 50g average for finger, 25g average with non-metal stylus.
- **Controller:** RS-232 interface
- **OS support** MS DOS, Windows 98/SE, Windows ME, Windows NT4.0, Windows 2000.

## Dimensions

### AMB-2023-E

Unit:mm

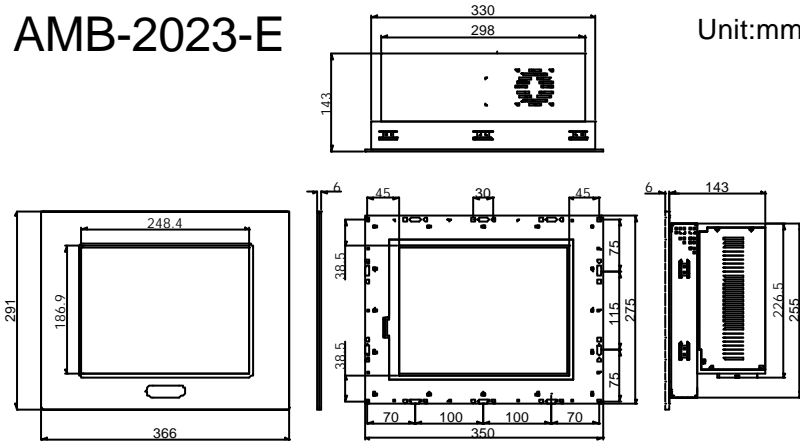

Front Bezel Size

Chassis Cutout Size:333\*258 mm  
LCD Cutout Size:248.4\*186.9 mm

### AMB-2053-E

Unit:mm

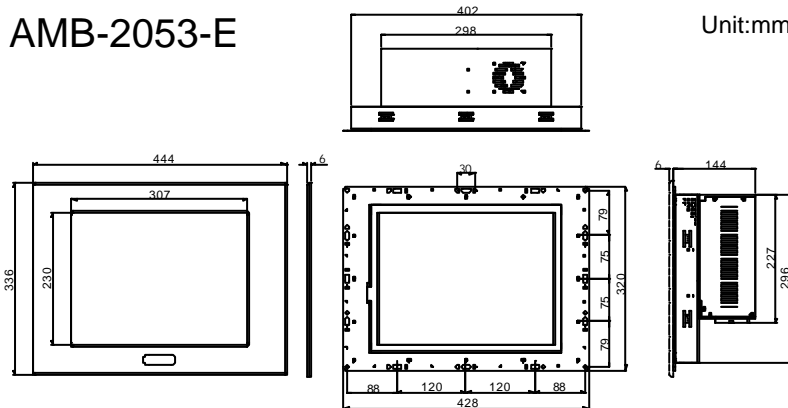

Front Bezel Size

Chassis Cutout Size:405\*299mm  
LCD Cutout Size:307\*230mm

## Panel Mounting

These display panels can be placed on a shelf or table, or mounted onto the wall. To mount them onto the wall, you need the mounting brackets, which you will find in the accessory box. Follows the steps described below:

1. Slide the display panel onto the wall
2. Tighten the brackets until the display panel is firmly secured to the wall.

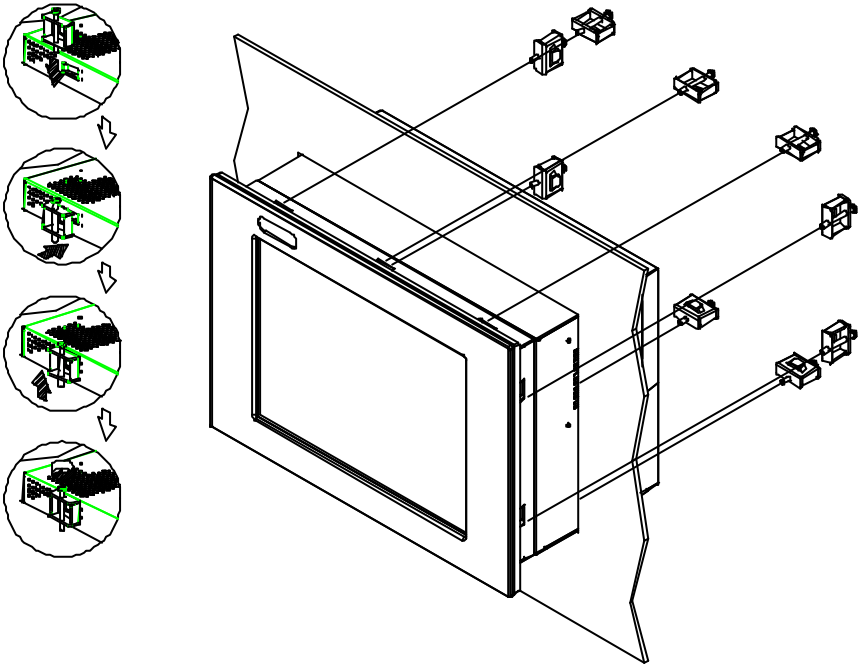

## Waterproof Sponge Position

Inside sponge:

- Tear off the protection paper on the self-adhesive side of the inside sponge.
- Stick the sponge on the recessed area of the Aluminum bezel or customer's own bezel.

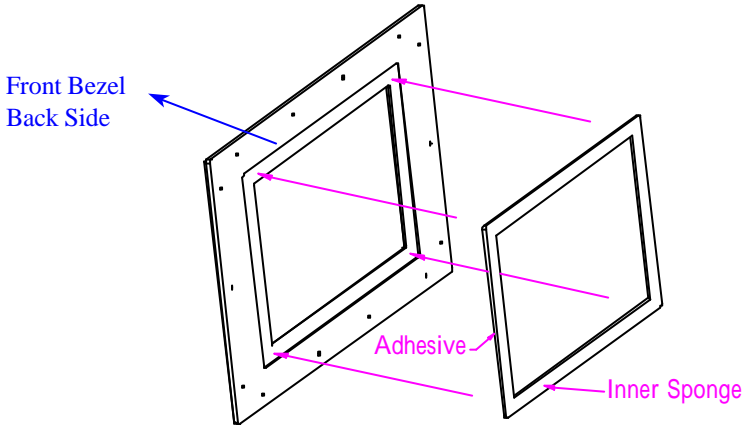

**Outer sponge :**

Press to close the outer sponge to the edge of the Panel PC.

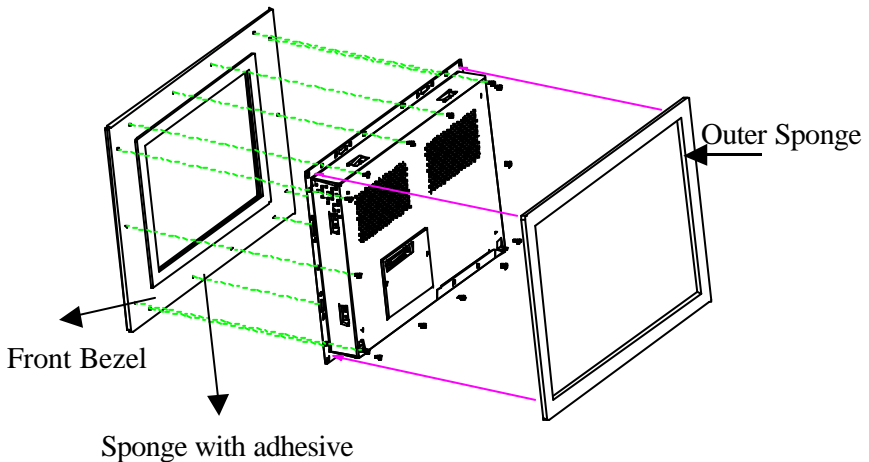

Chapter

2

**Jumper  
Settings**

## Safety precautions

---

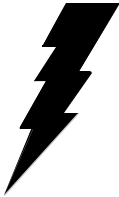
**Warning!**

*Always completely disconnect the power cord from your chassis whenever you are working on it. Do not make connections while the power is on because sensitive electronic components can be damaged by the sudden rush of power. Only experienced electronics personnel should open the PC chassis.*

**Caution!**

*Always ground yourself to remove any static charge before touching the CPU card. Modern electronic devices are very sensitive to static electric charges. Use a grounding wrist strap at all times. Place all electronic components on a static-dissipative surface or in a static-shielded bag when they are not in the chassis.*



## Locating jumpers

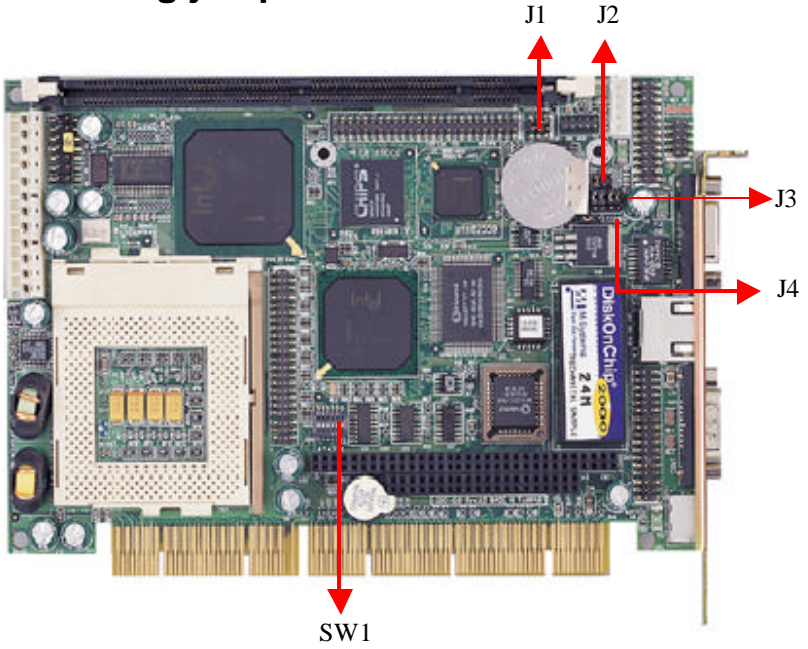

## List of Jumpers

The board has a number of jumpers that allow you to configure your system to suit your application.

The following tables show the function of each of the board's jumpers.

### Jumpers

Label	Function
J1	LCD clock signal & driving voltage select
J2	COM2 RS-232/422/485 select
J3	COM2 RS-232/422/485 select
J4	Clear CMOS Connectors
PWR1	Power connector

## Setting Jumpers

You configure your card to match the needs of your application by setting jumpers. A jumper is the simplest kind of electric switch. It consists of two metal pins and a small metal clip (often protected by a plastic cover) that slides over the pins to connect them. To “close” a jumper you connect the pins with the clip.

To “open” a jumper you remove the clip. Sometimes a jumper will have three pins, labeled 1, 2 and 3. In this case you would connect either pins 1 and 2 or 2 and 3.

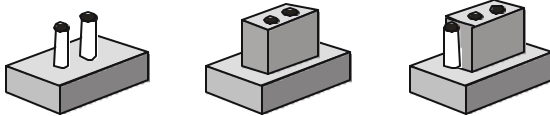

A pair of needle-nose pliers may be helpful when working with jumpers.

If you have any doubts about the best hardware configuration for your application, contact your local distributor or sales representative before you make any changes.

Generally, you simply need a standard cable to make most connections.

## LCD clock signal & driving voltage select (J1)

You can select the LCD connector CN2 driving voltage & control signal by setting J1. The configurations are as follows:

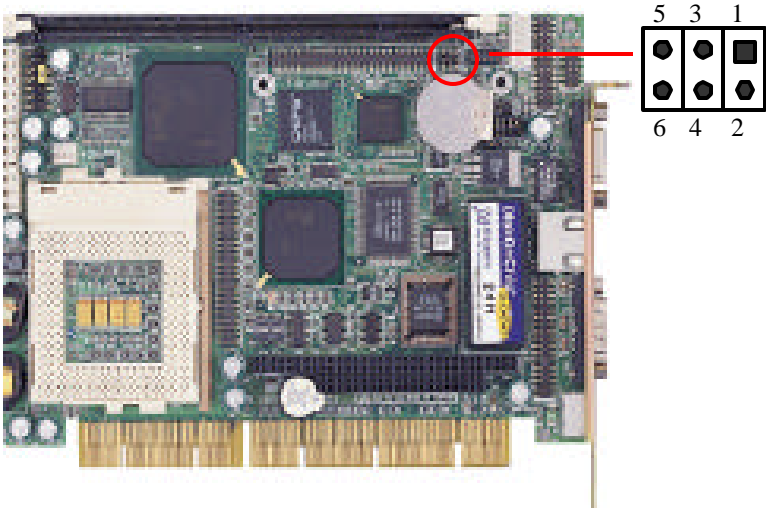

## LCD clock signal & driving voltage select (J1)

J1	Function
1-2, 3-4	ASHF CLK / +5V
1-3, 4-6	ASHFCLK / +3.3V
2-4, 3-5	SHFCLK / +5V
3-5, 4-6	SHFCLK / +3.3V *

\*Default

## COM2 RS-232/422/485 select (J2, J3)

The SBC-658 COM2 serial port can be selected as RS-232, RS-422, or RS-485 by setting J2 & J3.

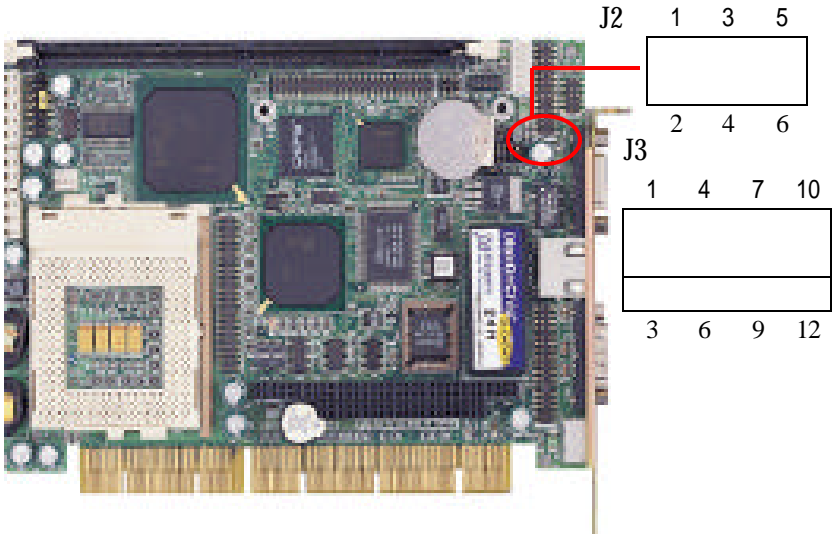

### COM2 Select (J2, J3)

J2	Function
1-2	RS-232 *
3-4	RS-422
5-6	RS-485

J3	Function
1-2, 4-5, 7-8, 10-11	RS-232 *
2-3, 5-6, 8-9, 11-12	RS-422
2-3, 5-6, 8-9, 11-12	RS-485

\*Default

## Clear CMOS (J4)

You can connect an external jumper cap or switch to clear CMOS.

Clear CMOS procedure:

1. Disconnect all power sources.
2. Move J4 from 1-2 to 2-3 for few seconds.
3. Move J4 back to 1-2.

## Clear CMOS (J4)

<b>J4</b>	<b>Function</b>
1-2	Protect *
2-3	Clear CMOS

\*Default

## DiskOnChip (DOC) 2000 Installation

When the DOC is installed correctly, a DOC will work like an HDD or an FDD. To install the DOC on the SBC-658, follow the instructions below:

1. Plug the DOC into the socket. Make sure pin 1 of the DOC is aligned with pin 1 of the socket.
2. Push the DOC into the socket until it is firmly seated in the socket.  
**Caution: the DOC may be permanently damage if it is installed incorrectly.**
3. Set the jumper for the memory address of the DOC.

### Note:

**The memory shadow function sometimes will create conflicts with the memory window. You should disable the memory shadow from the BIOS SETUP if the DOC cannot be accessed.**

### Configure DOC as a boot device

To configure a DOC as a boot drive, you should copy the operating system files onto the DOC. The following procedure is an example of the initialization process.

1. Install a DOC into your system.
2. Insert a bootable floppy disk in drive A: and boot the system.
3. At the DOS prompt, type **SYS C:** to transfer the DOS system files to the DOC (assuming the DiskOnChip is installed as drive C:). Reboot the system.
4. Go to the BIOS Setup Utility by hitting the <DEL> key. Set the type of Primary Master or C: Drive as *Not Installed*.
5. Remove the floppy disk from the drive A: and leave the BIOS Setup Utility. The system should boot from the DOC.

Chapter

3

**BIOS  
Settings**



## Starting setup

The Award BIOS is immediately activated when you first turn on the computer. The BIOS reads system configuration information in CMOS RAM and begins the process of checking out the system and configuring it through the power-on self test (POST).

When these preliminaries are finished, the BIOS seeks an operating system on one of the data storage devices (hard drive, floppy drive, etc.). The BIOS launches the operating system and hands control of system operations to it.

During POST, you can start the Setup program in one of two ways: 1.By pressing Del immediately after switching the system on, or 2.By pressing Del or pressing Ctrl-Alt-Esc when the following message appears briefly at the bottom of the screen during POST:

TO ENTER SETUP BEFORE BOOT PRESS DEL KEY

If the message disappears before you respond and you still wish to enter Setup, restart the system to try again by turning it OFF then ON or pressing the RESET button on the system case. You may also restart by simultaneously pressing Ctr-Alt-Del. If you do not press the keys at the correct time and the system does not boot, an error message appears and you are again asked to

PRESS F1 TO CONTINUE, DEL TO ENTER SETUP

## Setup keys

These keys help you navigate in Setup:

Up arrow	Move to previous item
Down arrow	Move to next item
Left arrow	Move to the item in the left hand
Right arrow	Move to the item in the right hand
Esc	Main Menu: Quit and not save changes into CMOS RAM Other pages: Exit current page and return to Main Menu
PgDn/+	Increase the numeric value or make changes
PgDn/-	Decrease the numeric value or make changes
F1	General help, only for Status Page Setup Menu and Option Page Setup Menu
F2	Change color from total 16 colors. F2 to select color forward, Shift-F2 to select color backward
F3	Calendar, only for Status Page Setup Menu
F4	Reserved
F5	Restore the previous CMOS value from CMOS, only for Option Page Setup Menu
F6	Load the default CMOS RAM value from BIOS default table, only for Option Page Setup Menu
F7	Load the default
F8	Reserved
F9	Reserved
F10	Save all the CMOS changes, only for Main Menu

## Getting help

Press F1 to pop up a small help window that describes the appropriate keys to use and the possible selections for the highlighted item. To exit the Help Window press Esc or the F1 key again.

## In Case of Problems

If, after making and saving system changes with Setup, you discover that your computer no longer is able to boot, the **AwardBIOS** supports an override to the CMOS settings that resets your system to its default configuration.

You can invoke this override by immediately pressing Insert; when you restart your computer. You can restart by either using the ON/OFF switch, the RESET button or by pressing Ctrl-Alt-Delete.

The best advice is to alter only settings that you thoroughly understand. In particular, do not change settings in the Chipset screen without a good reason. Award Software or your system manufacturer for the best performance and reliability has carefully chosen the Chipset defaults. Even a seemingly small change to the Chipset setup may cause the system to become unstable.

## Main setup Menu

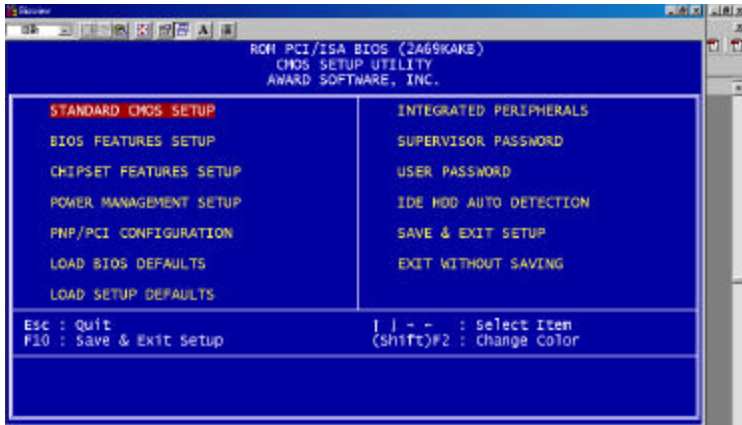

Standard CMOS	Options in the original PC AT-compatible BIOS.
BIOS Features	Award Software enhanced BIOS options.
Chipset Features	Options specific to your system chipset.
Power	Advanced Power Management (APM) Management options.
PnP/PCI	Plug and Play standard and PCI Local Bus Configuration configuration options.
Integrated Peripherals	I/O subsystems that depend on the integrated peripherals controller in your system.
Supervisor/User	Change, set, or disables a password. In Password Setting BIOS versions that allow separate user and supervisor passwords, only the supervisor password permits access to Setup. The user password generally allows only power-on access.
IDE HDD Auto Detection	Automatically detect and configure IDE hard disk parameters.
Load BIOS	BIOS defaults are factory settings for the Defaults most stable, minimal-performance system operations.

---

Load Setup	Setup defaults are factory settings for Defaults optimal-performance system operations.
Save & Exit	Save settings in nonvolatile CMOS RAM and Setup exit Setup.
Exit Without Save	Abandon all changes and exit Setup.

---

## Standard CMOS setup

When you choose the STANDARD CMOS SETUP option from the INITIAL SETUP SCREEN menu, the screen below is displayed.

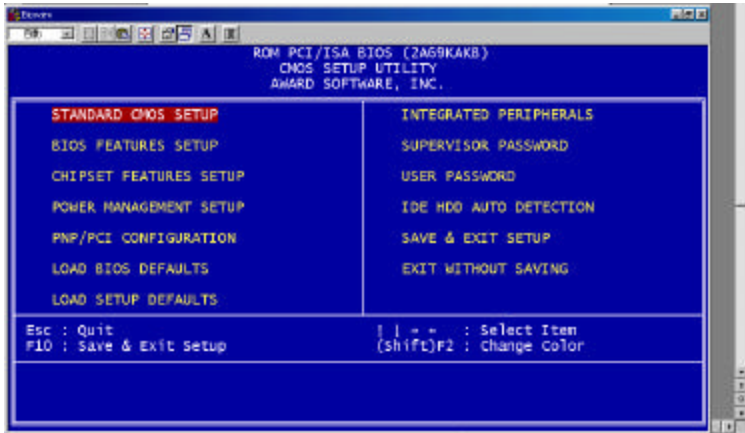

This standard setup menu allows users to configure system components such as the date, time, hard disk drive, floppy drive, display, and memory. Pressing F1 can access online help for each field.

### Date and Time Configuration

The BIOS determines the day of the week from the other date information. This field is for information only.

Press the left or right arrow key to move to the desired field (date, month, year). Press the PgUp/- or PgDn/+ key to increment the setting, or type the desired value into the field.

The time format is based on the 24-hour military-time clock. For example, 1 p.m. is 13:00:00. Press the left or right arrow key to move to the desired field. Press the PgUp/- or PgDn/+ key to increment the setting, or type the desired value into the field.

### HARD DISKS

The BIOS supports up to two IDE drives. This section does not show information about other IDE devices, such as a CD-ROM drive, or about other hard drive types, such as SCSI drives.

**NOTE:** We recommend that you select type AUTO for all drives.

The BIOS can automatically detect the specifications and optimal operating mode of almost all IDE hard drives. When you select type AUTO for a hard drive, the BIOS detect its specifications during POST, every time the system boots.

If you do not want to select drive type AUTO, other methods of selecting the drive type are available:

1. Match the specifications of your installed IDE hard drive(s) with the preprogrammed values for drive types 1 through 45.
2. Select USER and enter values into each drive parameter field.
3. Use the IDE HDD AUTO DETECTION function in Setup.

Here is a brief explanation of drive specifications:

• **Type:** The BIOS contains a table of pre-defined drive types. Each defined drive type has a specified number of cylinders, number of heads, write precompensation factor, landing zone, and number of sectors. Drives whose specifications do not accommodate any pre-defined type are classified as type USER.

• **Size:** Disk drive capacity (approximate). Note that this size is usually slightly greater than the size of a formatted disk given by a disk-checking program.

• **Cyls:** Number of cylinders

• **Head:** Number of heads

• **Precomp:** Write precompensation cylinder

• **Landz:** Landing zone

• **Sector:** Number of sectors

• **Mode:** Auto, Normal, large, or LBA

- **Auto:** The BIOS automatically determines the optimal mode.

- **Normal:** Maximum number of cylinders, heads, and sectors supported are 1024, 16, and 63.

- **Large:** For drives that do not support LBA and have more than 1024 cylinders.

- **LBA (Logical Block Addressing):** During drive accesses, the IDE controller transforms the data address described by sector, head, and cylinder number into a physical block address, significantly improving data transfer rates. For drives with greater than 1024 cylinders.

### Drive A

### Drive B

Select the correct specifications for the diskette drive(s) installed in the computer.

None	No diskette drive installed
360K, 5.25 in	5-1/4 inch PC-type standard drive; 360 kilobyte capacity
1.2M, 5.25 in	5-1/4 inch AT-type high-density drive; 1.2 megabyte capacity
720K, 3.5 in	3-1/2 inch double-sided drive; 720 kilobyte capacity
1.44M, 3.5 in	3-1/2 inch double-sided drive; 1.44 megabyte capacity
2.88M, 3.5 in	3-1/2 inch double-sided drive; 2.88 megabyte capacity

### LCD & CRT

This field may appear as an alternative to The Video field. Select your video display device:

LCD	Liquid crystal display
CRT	Auxiliary monitor
Both	Display on both devices

### Pannel:

This selection item allow user to select LCD BIOS to match the LCD types.

### Halt On

During the power-on-self-test (POST), the computer stops if the BIOS detect a hardware error. You can tell the BIOS to ignore certain errors during POST and continue the boot-up process. These are the selections:



- **No errors:** POST does not stop for any errors.
- **All errorsIf:** the BIOS detects any non-fatal error, POST stops and prompts you to take corrective action.
- **All, But Keyboard:** POST does not stop for a keyboard error, but stops for all other errors. All, But Diskette POST does not stop for diskette drive errors, but stops for all other errors.
- **All, But Disk/Key:** POST does not stop for a keyboard or disk error, but stops for all other errors.

## Memory

You cannot change any values in the Memory fields; they are only for your information. The fields show the total installed random access memory (RAM) and amounts allocated to base memory, extended memory, and other (high) memory. RAM is counted in kilobytes (KB: approximately one thousand bytes) and megabytes (MB: approximately one million bytes).

RAM is the computer's working memory, where the computer stores programs and data currently being used, so they are accessible to the CPU. Modern personal computers may contain up to 64 MB, 128 MB, or more.

### •Base Memory

Typically 640 KB. Also called conventional memory. The DOS operating system and conventional applications use this area.

### •Extended Memory

Above the 1-MB boundary. Early IBM personal computers could not use memory above 1 MB, but current PCs and their software can use extended memory.

### •Other Memory

Between 640 KB and 1 MB; often called High memory. DOS may load terminate-and-stay-resident (TSR) programs, such as device drivers, in this area, to free as much conventional memory as possible for applications. Lines in your CONFIG.SYS file that start with LOADHIGH load programs into high memory.

## BIOS features setup

By choosing the BIOS FEATURES SETUP option from the INITIAL SETUP SCREEN menu, the screen below is displayed.

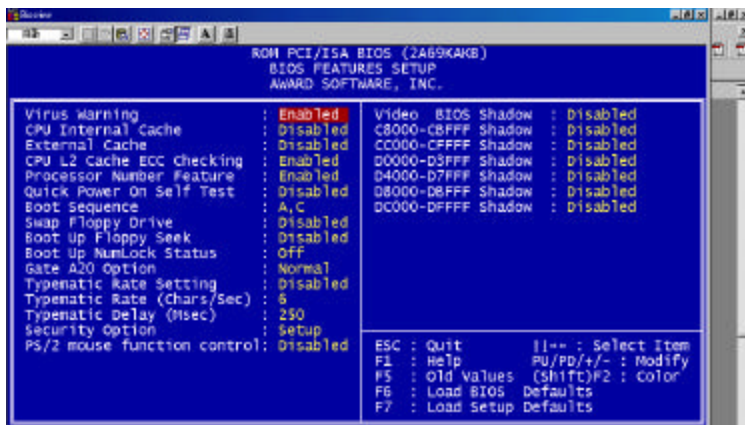

The displayed configuration is based on the manufacturer's SETUP DEFAULTS settings.

### Virus Warning

When enabled, you receive a warning message if a program (specifically, a virus) attempts to write to the boot sector or the partition table of the hard disk drive. You should then run an anti-virus program. Keep in mind that this feature protects only the boot sector, not the entire hard drive.

**NOTE:** Many disk diagnostic programs that access the boot sector table can trigger the virus warning message. If you plan to run such a program, we recommend that you first disable the virus warning.

### CPU Internal Cache/External Cache

Cache memory is additional memory that is much faster than conventional DRAM (system memory). CPUs from 486-type on up contain internal cache memory, and most, but not all, modern PCs have additional (external) cache memory. When the CPU requests data, the system transfers the requested data from the main DRAM into cache memory, for even faster access by the CPU.

The External Cache field may not appear if your system does not have external cache memory.

**CPU L2 Cache ECC Checking**

When you select Enabled, memory checking is enable when the external cache contains ECC SRAMs.

**Quick Power On Self Test**

Select Enabled to reduce the amount of time required to run the power-on-self-test (POST). A quick POST skips certain steps. We recommend that you normally disable quick POST. Better to find a problem during POST than lose data during your work.

**Shadow**

Software that resides in a read-only memory (ROM) chip on a device is called firmware. The AwardBIOS permits shadowing of firmware such as the system BIOS, video BIOS, and similar operating instructions that come with some expansion peripherals, such as, for example, a SCSI adaptor.

Shadowing copies firmware from ROM into system RAM, where the CPU can read it through the 16-bit or 32-bit DRAM bus. Firmware not shadowed must be read by the system through the 8-bit X-bus. Shadowing improves the performance of the system BIOS and similar ROM firmware for expansion peripherals, but it also reduces the amount of high memory (640 KB to 1 MB) available for loading device drivers, etc.

Enable shadowing into each section of memory separately. Many system designers hardwire shadowing of the system BIOS and eliminate a System BIOS Shadow option.

Video BIOS shadows into memory area C8000-DFFFF. The remaining areas shown on the BIOS Features Setup screen may be occupied by other expansion card firmware. If an expansion peripheral in your system contains ROM-based firmware, you need to know the address range the ROM occupies to shadow it into the correct area of RAM.

## CHIPSET features setup

By choosing the CHIPSET FEATURES SETUP option from the INITIAL SETUP SCREEN menu, the screen below is displayed.

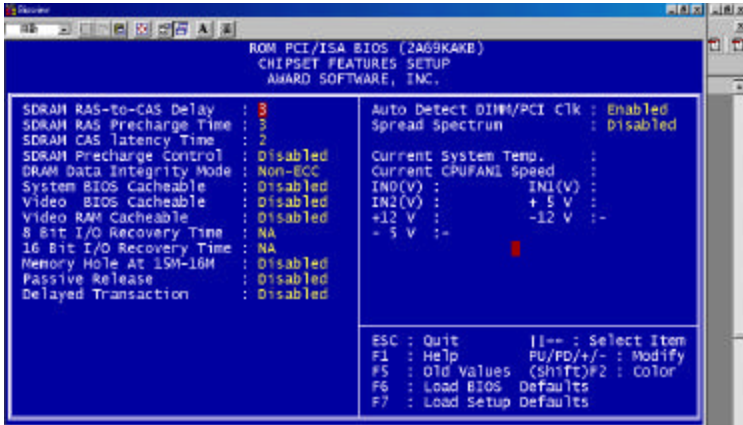

The displayed configuration is based on the manufacturer's SETUP DEFAULTS settings.

This section allows you to configure the system based on the specific features of the installed chipset. This chipset manages bus speeds and access to system memory resources, such as SDRAM. It also coordinates communications between the conventional ISA bus and the PCI bus. It must be stated that these items should never need to be altered. The default settings have been chosen because they provide the best operating conditions for your system. The only time you might consider making any changes would be if you discovered that data was being lost while using your system.

Because of the complexity and technical nature of some of the options, not all of the options are described here.

### SDRAM RAS-to-CAS Delay

This field lets you control the number of DCLKs between a Row Activate command and a read or write command.

### SDRAM RAS Precharge Time

The precharge time is the number of cycles it takes for the RAS to accumulate its charge before DRAM refresh. If insufficient time is allowed, refresh may be incomplete and the DRAM may fail to retain data. This field applies only if synchronous DRAM is installed in the system.

**SDRAM CAS Latency Time**

When synchronous DRAM is installed, you can control the number of CLKs between when the SDRAMs sample a read command and when the controller samples read data from the SDRAMs. Do not reset this field from the default value specified by the system designer.

**SDRAM Precharge Control**

When Enabled, all CPU cycles to SDRAM result in an All Banks Precharge Command on the SDRAM interface.

**DRAM Data Integrity Mode**

Select Non-ECC or ECC (error-correcting code), according to the type of installed DRAM.

**System BIOS Cacheable**

Selecting Enabled allows caching of the system BIOS ROM at F0000h-FFFFFh, resulting in better system performance. However, if any program writes to this memory area, a system error may result.

**Video BIOS Cacheable**

Selecting Enabled allows caching of the video BIOS ROM at C0000h to C7FFFh, resulting in better video performance. However, if any program writes to this memory area, a system error may result.

**Video RAM Cacheable**

Selecting Enabled allows caching of the video memory (RAM) at A0000h to AFFFFh, resulting in better video performance. However, if any program writes to this memory area, a memory access error may result.

**8/16 Bit I/O Recovery Time**

The I/O recovery mechanism adds bus clock cycles between PCI-originated I/O cycles to the ISA bus. This delay takes place because the PCI bus is so much faster than the ISA bus.

These two fields let you add recovery time (in bus clock cycles) for 16-bit and 8-bit I/O.

**Memory Hole at 15M-16M**

You can reserve this area of system memory for ISA adapter ROM. When this area is reserved, it cannot be cached. The user information of peripherals that

need to use this area of system memory usually discusses their memory requirements.

**Passive Release**

When Enabled, CPU to PCI bus accesses are allowed during passive release.

Otherwise, the arbiter only accepts another PCI master access to local DRAM.

**Delayed Transaction**

The chipset has an embedded 32-bit posted write buffer to support delay transactions cycles. Select Enabled to support compliance with PCI specification version 2.1.

**Auto Detect DIMM/PCI Clk**

When the Auto Detect DIMM/PCI clk enable, the Utility will automatically detect the DIMM/PCI clock in your system.

**Spread Spectrum**

When the system clock generator pulses, the extreme values of the pulse generate excess EMI. Enabling pulse spectrum spread modulation changes the extreme values from spikes to flat curves, thus reducing EMI. This benefit may in some cases be outweighed by problems with timing-critical devices, such as a clock-sensitive SCSI device

**IN0-IN6(V)**

These fields display the current voltage of up to seven voltage input lines, if your computer contains a monitoring system.

## Power management setup

By choosing the POWER MANAGEMENT option from the INITIAL SETUP SCREEN menu, the screen below is displayed.

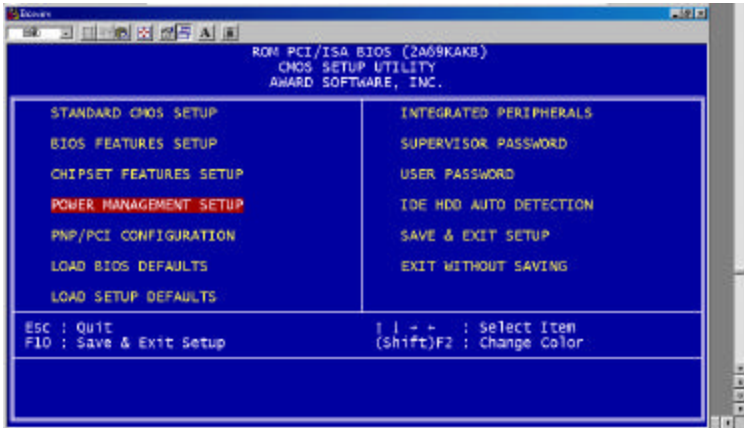

The displayed configuration is based on the manufacturer's SETUP DEFAULTS settings.

### Power Management

This option allows you to select the type (or degree) of power saving for Doze, Standby, and Suspend modes.

This table describes each power management mode:

Max Saving	Maximum power savings. Only Available for SL CPUs. Inactivity period is 1 minute in each mode.
User Define	Set each mode individually. Select time-out periods in the section for each mode, below.
Min Saving	Minimum power savings. Inactivity period is 1 hour in each mode (except the hard drive).

### PM Control by APM

If Advanced Power Management (APM) is installed on your system, selecting Yes gives better power savings.

### Video Off Method

Determines the manner in which the monitor is blanked.

V/H SYNC+Blank	System turns off vertical and horizontal synchronization ports and writes blanks to the video buffer.
DPMS Support	Select this option if your monitor supports the Display Power Management Signaling (DPMS) standard of the Video Electronics Standards Association (VESA). Use the software supplied for your video subsystem to select video power management values.
Blank Screen	System only writes blanks to the video buffer.

### Video Off After

As the system moves from lesser to greater power-saving modes, select the mode in which you want the monitor to blank.

### MODEM Use IRQ

Name the interrupt request (IRQ) line assigned to the modem (if any) on your system. Activity of the selected IRQ always awakens the system.



**Doze Mode**

After the selected period of system inactivity, the CPU clock throttles to a small percentage of its duty cycle – between 10 percent and 25 percent for most chipsets. All other devices still operate at full speed.

**Standby Mode**

After the selected period of system inactivity, the CPU clock stops, the hard drive enters an idle state, and the L2 cache enters a power-save mode. All other devices still operate at full speed.

**Suspend Mode**

After the selected period of system inactivity, the chipset enters a hardware suspend mode, stopping the CPU clock and possibly causing other system devices to enter power management modes.

**HDD Power Down**

After the selected period of drive inactivity, any system IDE devices compatible with the ATA-2 specification or later power manage themselves, putting themselves into an idle state after the specified timeout and then waking themselves up when accessed.

**Throttle Duty Cycle**

When the system enters Doze mode, the CPU clock runs only part of the time. You may select the percent of time that the clock runs.

**VGA Active Monitor**

When Enabled, any video activity restarts the global timer for Standby mode.

**IRQ8 Break [Event From] Suspend**

You can select Enabled or Disabled for monitoring of IRQ8 (the Real Time Clock) so it does not awaken the system from Suspend mode.

**Reload Global Timer Events**

When Enabled, an event occurring on each device listed below restarts the global timer for Standby mode.

**IRQ3-7, 9-15, NMI**

**Primary IDE 0**

**Primary IDE 1**

**Floppy Disk**

**Serial Port**

**Parallel Port**

## PNP/PCI configuration setup

By choosing the PNP/PCI CONFIGURATION SETUP option from the initial SETUP SCREEN menu, the screen below is displayed.

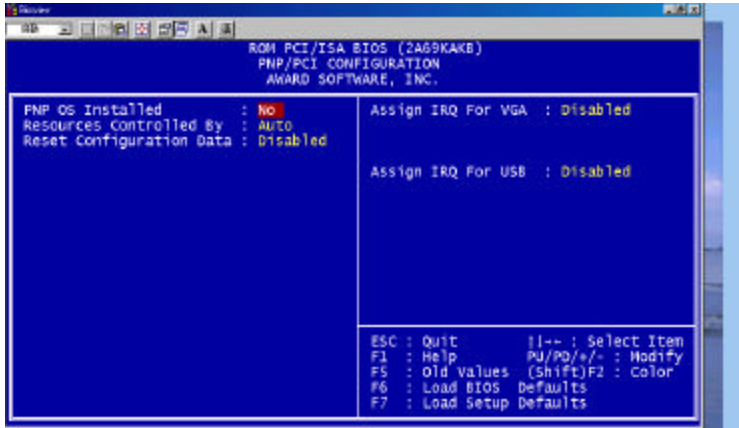

The displayed configuration is based on the manufacturer's SETUP DEFAULTS settings.

**NOTE:** This chapter describes all fields offered by Award Software in this screen. Your system board designer may omit or modify some fields.

### PNP OS Installed

Select Yes if the system operating environment is Plug-and-Play aware (e.g., Windows 95).

### Resources Controlled By

The Plug and Play Award BIOS can automatically configure all the boot and Plug and Play-compatible devices. If you select Auto, all the interrupt request (IRQ) and DMA assignment fields disappear, as the BIOS automatically assigns them.

### Reset Configuration Data

Normally, you leave this field Disabled. Select Enabled to reset Extended System Configuration Data (ESCD) when you exit Setup if you have installed a new add-on and the system reconfiguration has caused such a serious conflict that the operating system cannot boot.

### Assign IRQ for VGA

If you are not using your system's VGA controller, select Disabled to free the IRQ resource.

**Assign IRQ for USB**

Select Enabled if your system has a USB controller and you have one or more USB devices connected. If you are not using your system's USB controller, select Disabled to free the IRQ resource.

## Load BIOS defaults/Load setup

### Defaults

LOAD BIOS DEFAULTS loads the default system values directly from ROM. The BIOS DEFAULTS provides the most stable settings, though they do not provide optimal performance. LOAD SETUP DEFAULTS, on the other hand, provides for maximum system performance. If the stored record created by the setup utility becomes corrupted (and therefore unusable), BIOS defaults will load automatically when you turn the system on.

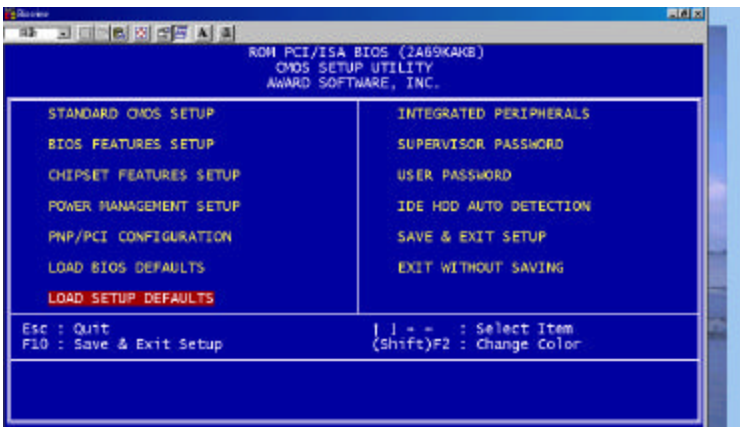
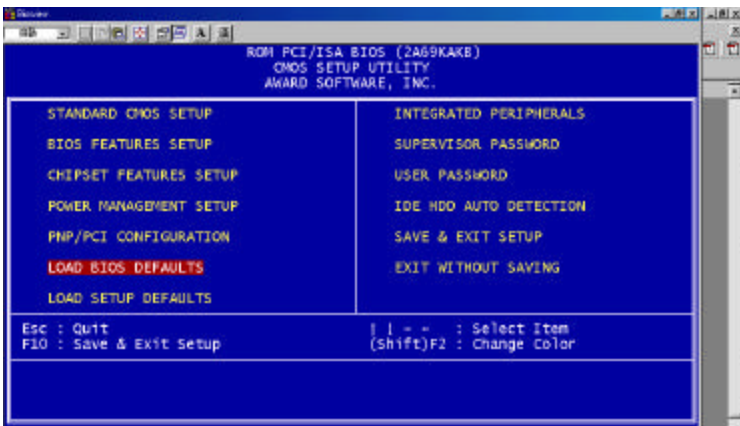

## Integrated peripherals setup

By choosing the INTEGRATED PERIPHERALS option from the initial SETUP SCREEN menu, the screen below is displayed.

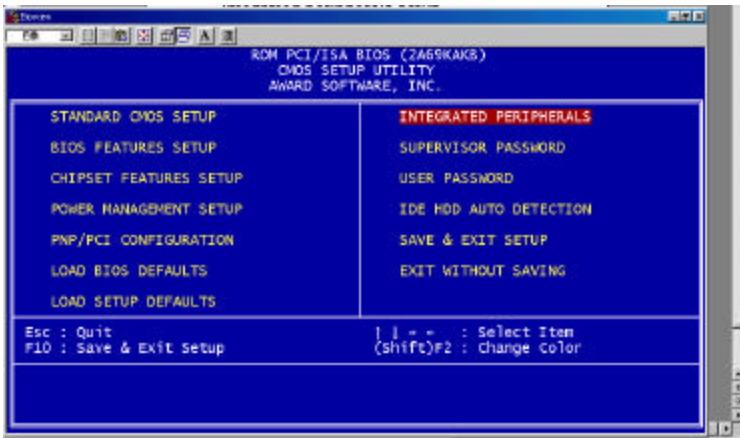

The displayed configuration is based on the manufacturer's SETUP DEFAULTS settings.

### IDE HDD Block Mode

Select Enabled only if your hard drives support block mode.

### IDE Primary Master/Slave UDMA

UDMA (Ultra DMA) is a DMA data transfer protocol that utilizes ATA commands and the ATA bus to allow DMA commands to transfer data at a maximum burst rate of 33 MB/s. When you select Auto in the four IDE UDMA fields (for each of up to four IDE devices that the internal PCI IDE interface supports), the system automatically determines the optimal data transfer rate for each IDE device.

### On-Chip PCI IDE Primary

The system chipset contains a PCI IDE interface with support for two IDE channels. Select Enabled to activate the primary and/or secondary IDE interface. Select Disabled to deactivate this interface, if you install a primary and/or secondary add-in IDE interface.

**USB Keyboard Support**

Select Enabled if your system contains a Universal Serial Bus (USB) controller and you have a USB keyboard.

**Onboard FDC Controller**

Select Enabled if your system has a floppy disk controller (FDC) installed on the system board and you wish to use it. If you install an add-in FDC or the system has no floppy drive, select Disabled in this field.

**Onboard Serial Ports (1, 2)**

Select a logical COM port address for the first and second serial ports.

**RxD, TxD Active**

Consult your IR peripheral documentation to select the correct setting of the TxD and RxD signals.

**ECP Mode Use DMA**

Select a DMA channel for the port.

**EPP Mode select**

Select EPP port type 1.7 or 1.9.

## Supervisor/User password setting

You can set either SUPERVISOR or USER PASSWORD, or both of them. The difference between the two is that the supervisor password allows unrestricted access to enter and change the options of the setup menus, while the user password only allows entry to the program, but not modify options.

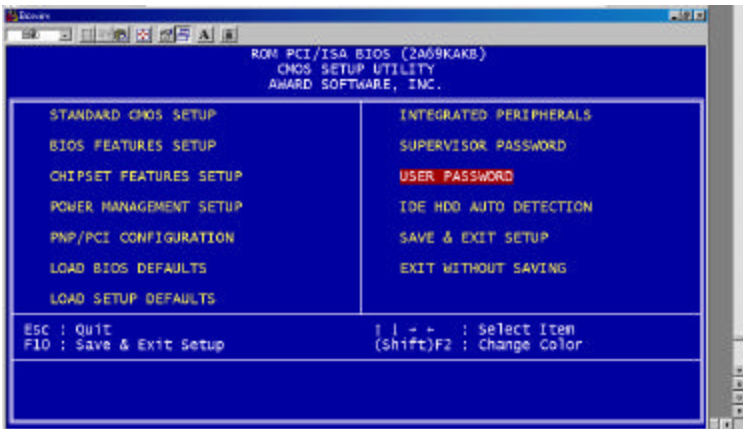
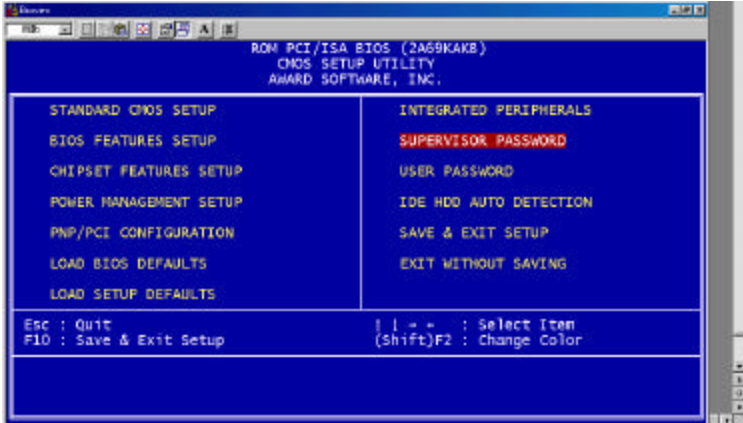

When you select this function, a message appears at the center of the screen:

### ENTER PASSWORD:

Type the password, up to eight characters, and press Enter. Typing a password clears any previously entered password from CMOS memory.



Now the message changes:

**CONFIRM PASSWORD:**

Again, type the password and press Enter.

To abort the process at any time, press Esc.

In the Security Option item in the BIOS Features Setup screen, select System or Setup:

**System** Enter a password each time the system boots and when ever you enter Setup.

**Setup** Enter a password when ever you enter Setup.

***NOTE: To clear the password, simply press Enter when asked to enter a password. Then the password function is disabled.***

## IDE HDD auto detection

The IDE HDD AUTO DETECTION utility can automatically detect the IDE hard disk installed in your system. You can use it to self-detect and/or correct the hard disk type configuration. You need to repeat the setup for each of the IDE combinations:

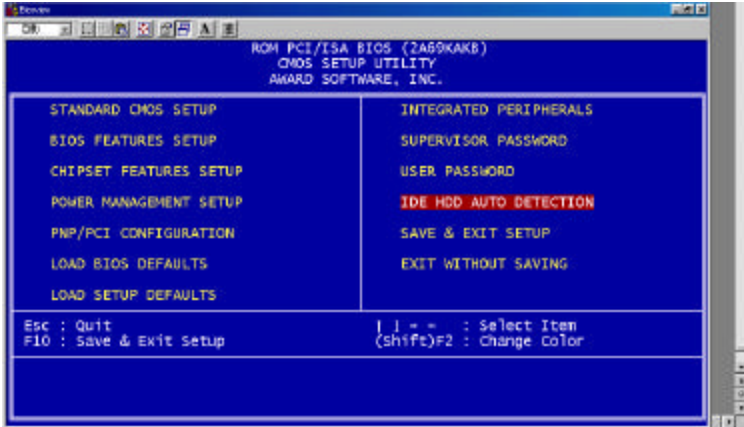

## Save & exit setup

If you select this option and press <ENTER>, the values entered in the setup utility will be recorded in the chipset's CMOS memory. The microprocessor will check this every time you turn your system on and compare this to what it finds as it checks the system. This record is required for the system to operate.

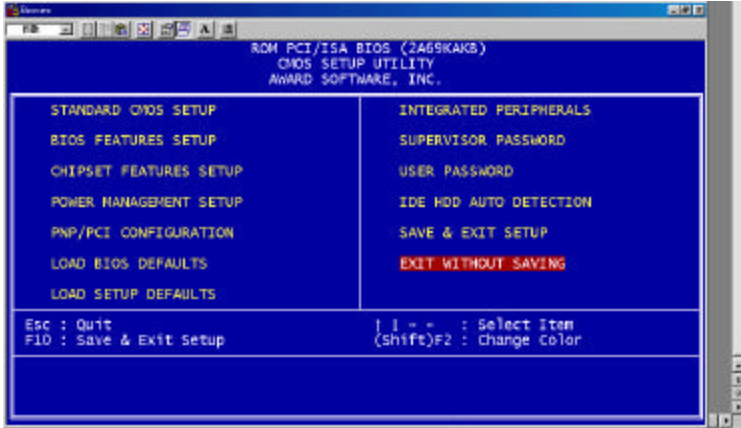

Chapter

4

**Appendix**

## LCD Panel Configuration

Only for AMB-2051HT/HTT series, AMB-2053HT/HTT series, AMB-2021HT-C1, AMB-2021HTT-C1, AMB-2023HT-C1 and AMB-2023HTT-C3 products.

If you want to use the SCSI cable for external panel, please set the CMOS option like this:

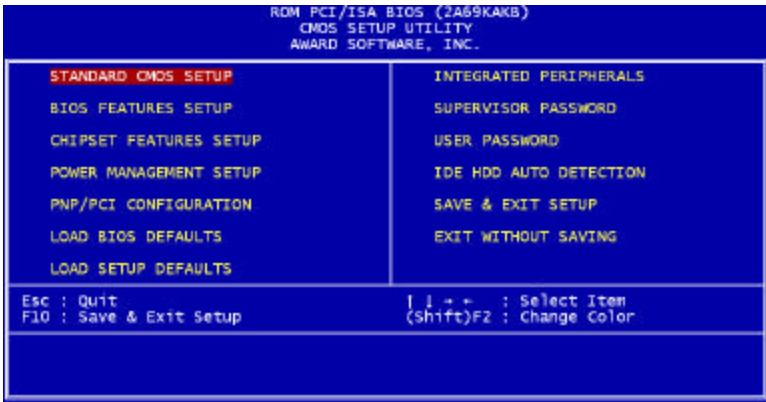

In Standard CMOS Setup  
Select **AMB-2212 External** in the panel option

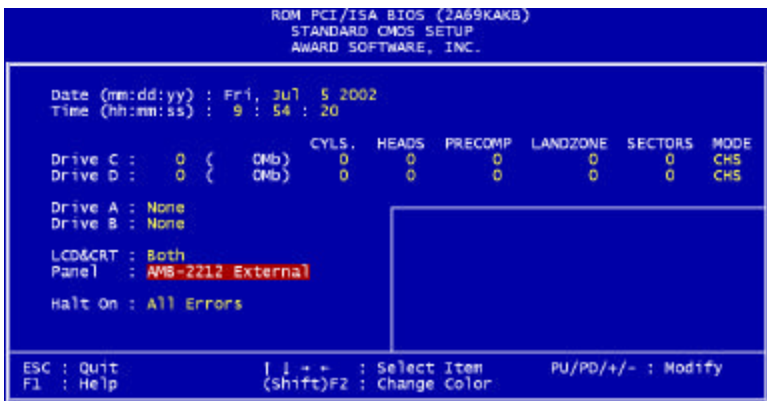

If your panel doesn't work with external, please set the CMOS option like this:

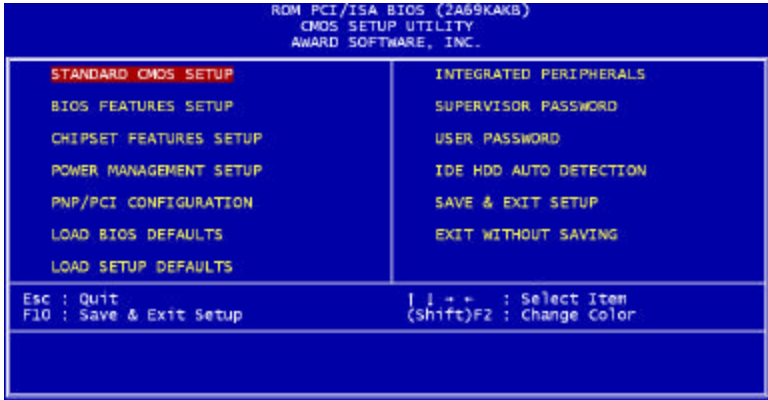

In Standard CMOS Setup

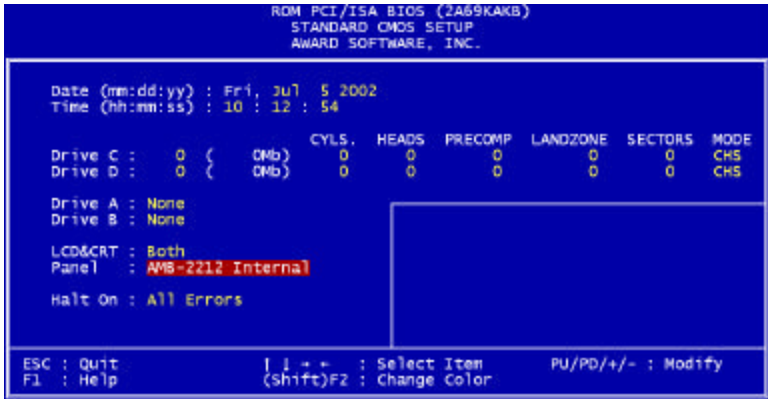

AMB-2021HT-C1, AMB-2021HTT-C1 AMB-2023HT-C1, AMB-2023HTT-C3	Select <b>AMB-2212 Internal</b> in the panel option
AMB-2051HT/HTT series AMB-2053HT/HTT series	Select <b>AMB-2215 Internal</b> in the panel option