

AIOT-QG

IoT Gateway System

User's Manual 1st Ed

Copyright Notice

This document is copyrighted, 2015. All rights are reserved. The original manufacturer reserves the right to make improvements to the products described in this manual at any time without notice.

No part of this manual may be reproduced, copied, translated, or transmitted in any form or by any means without the prior written permission of the original manufacturer. Information provided in this manual is intended to be accurate and reliable. However, the original manufacturer assumes no responsibility for its use, or for any infringements upon the rights of third parties that may result from its use.

The material in this document is for product information only and is subject to change without notice. While reasonable efforts have been made in the preparation of this document to assure its accuracy, AAEMON assumes no liabilities resulting from errors or omissions in this document, or from the use of the information contained herein.

AAEMON reserves the right to make changes in the product design without notice to its users.

Acknowledgement

All other products' name or trademarks are properties of their respective owners.

- Microsoft Windows® is a registered trademark of Microsoft Corp.
- ITE is a trademark of Integrated Technology Express, Inc.
- IBM, PC/AT, PS/2, and VGA are trademarks of International Business Machines Corporation.

All other product names or trademarks are properties of their respective owners.

Packing List

Before setting up your product, please make sure the following items have been shipped:

Item	Quantity
● AIOT-QG	1
● Product CD with User's Manual (in pdf)	1

If any of these items are missing or damaged, please contact your distributor or sales representative immediately.

About this Document

This User's Manual contains all the essential information, such as detailed descriptions and explanations on the product's hardware and software features (if any), its specifications, dimensions, jumper/connector settings/definitions, and driver installation instructions (if any), to facilitate users in setting up their product.

Users may refer to the AAEON.com for the latest version of this document.

Safety Precautions

Please read the following safety instructions carefully. It is advised that you keep this manual for future references

1. All cautions and warnings on the device should be noted.
2. Make sure the power source matches the power rating of the device.
3. Position the power cord so that people cannot step on it. Do not place anything over the power cord.
4. Always completely disconnect the power before working on the system's hardware.
5. No connections should be made when the system is powered as a sudden rush of power may damage sensitive electronic components.
6. If the device is not to be used for a long time, disconnect it from the power supply to avoid damage by transient over-voltage.
7. Always disconnect this device from any AC supply before cleaning.
8. While cleaning, use a damp cloth instead of liquid or spray detergents.
9. Make sure the device is installed near a power outlet and is easily accessible.
10. Keep this device away from humidity.
11. Place the device on a solid surface during installation to prevent falls
12. Do not cover the openings on the device to ensure optimal heat dissipation.
13. Watch out for high temperatures when the system is running.
14. Do not touch the heat sink or heat spreader when the system is running
15. Never pour any liquid into the openings. This could cause fire or electric shock.
16. As most electronic components are sensitive to static electrical charge, be sure to ground yourself to prevent static charge when installing the internal components. Use a grounding wrist strap and contain all electronic components in any static-shielded containers.

17. If any of the following situations arises, please the contact our service personnel:
 - i. Damaged power cord or plug
 - ii. Liquid intrusion to the device
 - iii. Exposure to moisture
 - iv. Device is not working as expected or in a manner as described in this manual
 - v. The device is dropped or damaged
 - vi. Any obvious signs of damage displayed on the device
18. **DO NOT LEAVE THIS DEVICE IN AN UNCONTROLLED ENVIRONMENT WHERE THE STORAGE TEMPERATURE IS BELOW -20° C (-4°F) OR ABOVE 60°C (140°F) TO PREVENT DAMAGE.**

Warning!



This device complies with Part 15 FCC Rules. Operation is subject to the following two conditions: (1) this device may not cause harmful interference, and (2) this device must accept any interference received including interference that may cause undesired operation.

Caution:

There is a danger of explosion if the battery is incorrectly replaced. Replace only with the same or equivalent type recommended by the manufacturer. Dispose of used batteries according to the manufacturer's instructions and your local government's recycling or disposal directives.

Attention:

Il y a un risque d'explosion si la batterie est remplacée de façon incorrecte. Ne la remplacer qu'avec le même modèle ou équivalent recommandé par le constructeur. Recycler les batteries usées en accord avec les instructions du fabricant et les directives gouvernementales de recyclage.

China RoHS Requirements (CN)

产品中有毒有害物质或元素名称及含量

AAEON Boxer PC/ Industrial System

部件名称	有毒有害物质或元素					
	铅 (Pb)	汞 (Hg)	镉 (Cd)	六价铬 (Cr(VI))	多溴联苯 (PBB)	多溴二苯醚 (PBDE)
印刷电路板 及其电子组件	×	○	○	○	○	○
外部信号 连接器及线材	×	○	○	○	○	○
外壳	×	○	○	○	○	○
中央处理器 与内存	×	○	○	○	○	○
硬盘	×	○	○	○	○	○
电源	×	○	○	○	○	○

O: 表示该有毒有害物质在该部件所有均质材料中的含量均在 SJ/T 11363-2006 标准规定的限量要求以下。

X: 表示该有毒有害物质至少在该部件的某一均质材料中的含量超出 SJ/T 11363-2006 标准规定的限量要求。

备注:

一、此产品所标示之环保使用期限，系指在一般正常使用状况下。

二、上述部件物质中央处理器、内存、硬盘、电源为选购品。

China RoHS Requirement (EN)

Poisonous or Hazardous Substances or Elements in Products

AAEON Boxer PC/ Industrial System

Component	Poisonous or Hazardous Substances or Elements					
	Lead (Pb)	Mercury (Hg)	Cadmium (Cd)	Hexavalent Chromium (Cr(VI))	Polybrominated Biphenyls (PBB)	Polybrominated Diphenyl Ethers (PBDE)
PCB & Other Components	X	○	○	○	○	○
Wires & Connectors for External Connections	X	○	○	○	○	○
Chassis	X	○	○	○	○	○
CPU & RAM	X	○	○	○	○	○
Hard Disk	X	○	○	○	○	○
PSU	X	○	○	○	○	○

O: The quantity of poisonous or hazardous substances or elements found in each of the component's parts is below the SJ/T 11363-2006-stipulated requirement.

X: The quantity of poisonous or hazardous substances or elements found in at least one of the component's parts is beyond the SJ/T 11363-2006-stipulated requirement.

Note: The Environment Friendly Use Period as labeled on this product is applicable under normal usage only

Table of Contents

Chapter 1 - Product Specifications	1
1.1 Specifications.....	2
Chapter 2 – Hardware Information.....	4
2.1 Dimensions	5
2.2 Jumpers and Connectors (Board).....	8
2.3 List of Jumpers	9
2.3.1 Serial RS-232/422/485 Selector (JP1,2,3)	10
2.4 List of Connectors	12
2.4.1 JTAG Programming Port Box Header (CN1)	15
2.4.2 Battery Box Header (CN2)	15
2.4.3 ADC Box Header (CN3).....	16
2.4.4 10/100 RJ-45 Connector (LAN1) (CN4).....	17
2.4.5 10/100 RJ-45 Connector (LAN2) (CN5).....	17
2.4.6 Mini USB Host Port Connector (CN6)	18
2.4.7 Hub Dual USB Connector (USB1,2) (CN7).....	18
2.4.8 Hub Dual USB Box Header (USB3,4) (CN8)	19
2.4.9 Digital I/O Box Header (CN9)	20
2.4.10 ZigBee / Energy SPI Module Box Header (CN10)	21
2.4.11 I2C Box Header (CN11).....	22
2.4.12 Micro SD Card Connector (CN12)	22
2.4.13 Serial Port RS-232/422/485 Connector (COM1) (CN14)	23
2.4.14 Serial Port Box Header (COM2) (CN15).....	24
2.4.15 DC 5V or 9V~24V Input Connector (CN16).....	25
2.4.16 DC 5V or 9V~24V Input Connector (CN17).....	25
2.4.17 Power LED Box Header (CN18)	25
2.4.18 Micro SIM Socket (CN35).....	26

2.4.19	SD LED Header (CN36)	26
2.4.20	LED Assignments (LED1,2).....	26
2.4.21	Front Panel Connector (J1)	27
2.4.22	SPI JTAG Programming Port (J2)	27
2.5	Preloaded Drivers.....	28

Chapter 1

Product Specifications

1.1 Specifications

System

- **Processor** Intel® Quark™ SoC X1021
- **Chipset** Intel® Quark™ SoC X1021
- **System Memory** Onboard 1 GB DDR3 800 MHz, ECC, un-buffered memory
- **Display Interface** N/A
- **Storage Device** Micro SD Slot x 1
- **Front I/O**
 - Analog input x 1
 - Digital I/O x 1
 - Power input x 1
 - Serial port (RS-232) x 1
 - Power LED x 1
 - Antenna hole x 2 (optional)
- **Rear I/O**
 - USB 2.0 x 2
 - Mini USB x 1
 - Serial Port (RS-232/422/485) x 1
 - LAN (RJ-45) port x 2
 - Reset button x 1
 - Lockable DC connector x 1
 - Antenna hole x 2 (optional)
- **Expansion Slot**
 - Full-size Mini-PCIe slot for PCIe and USB host x 1
 - Half-size Mini-PCIe slot for PCIe x 1
 - SPI slot for optional modules

- **OS Support** Wind River (with Moon Island Program)
Yocto Linux

Mechanical

- **Mounting** Wall mounted
VESA mounted
- **Dimension (W x H x D)** 174 x 121.2 x 32 mm (6.85 x 4.77 x 1.26")
- **Gross Weight** 0.47 kg (1.03 lb)

Environmental

- **Operating Temperature** -20 ~ 70°C (-4 ~ 158°F) - with airflow
- **Storage Temperature** -30 ~ 80°C (-22 ~ 176°F)
- **Storage Humidity** 5 ~ 90% @ 40oC, non-condensing
- **Anti-Vibration** 1 Grms/ 5~500 Hz/ operation- HDD
- **Anti-Shock** 15 G peak acceleration (11 msec. duration) - HDD
- **EMC** CE/FCC Class A

Power Supply

- **DC Input** 9 ~ 24 V

Chapter 2

Hardware Information

2.1 Dimensions

Device

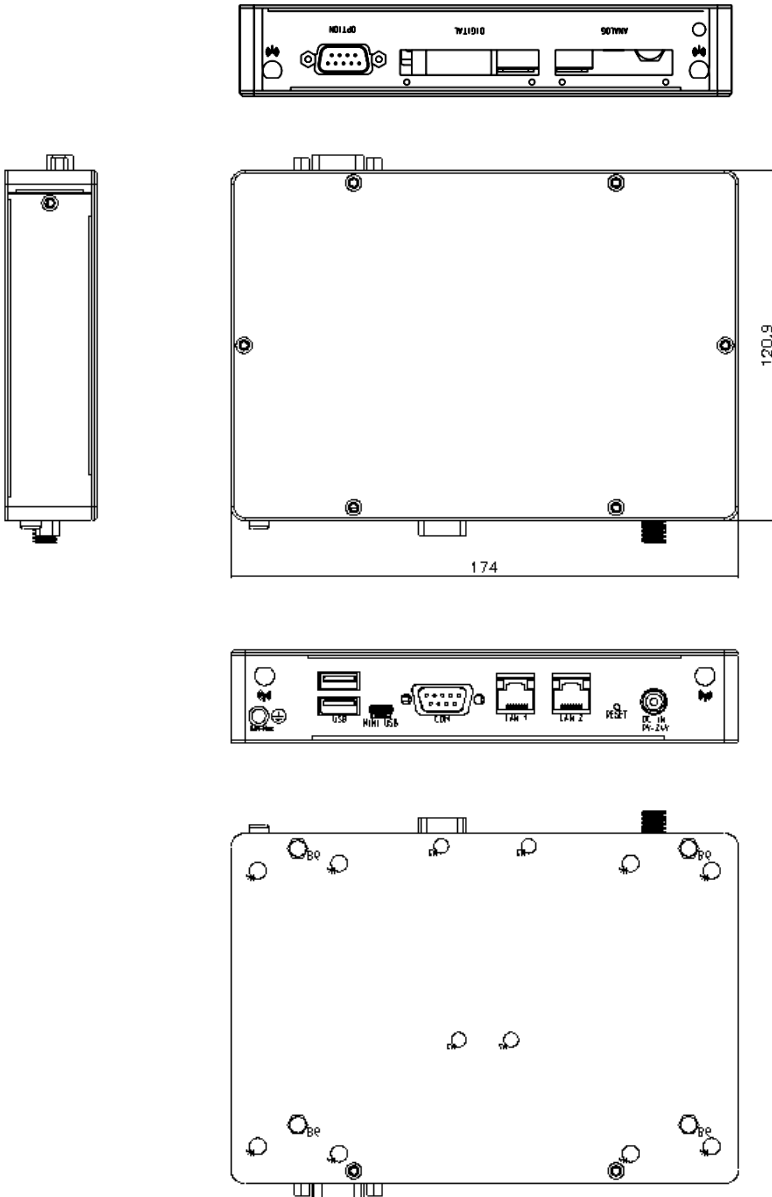

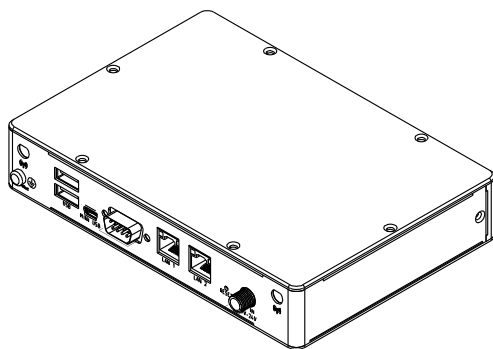

Board

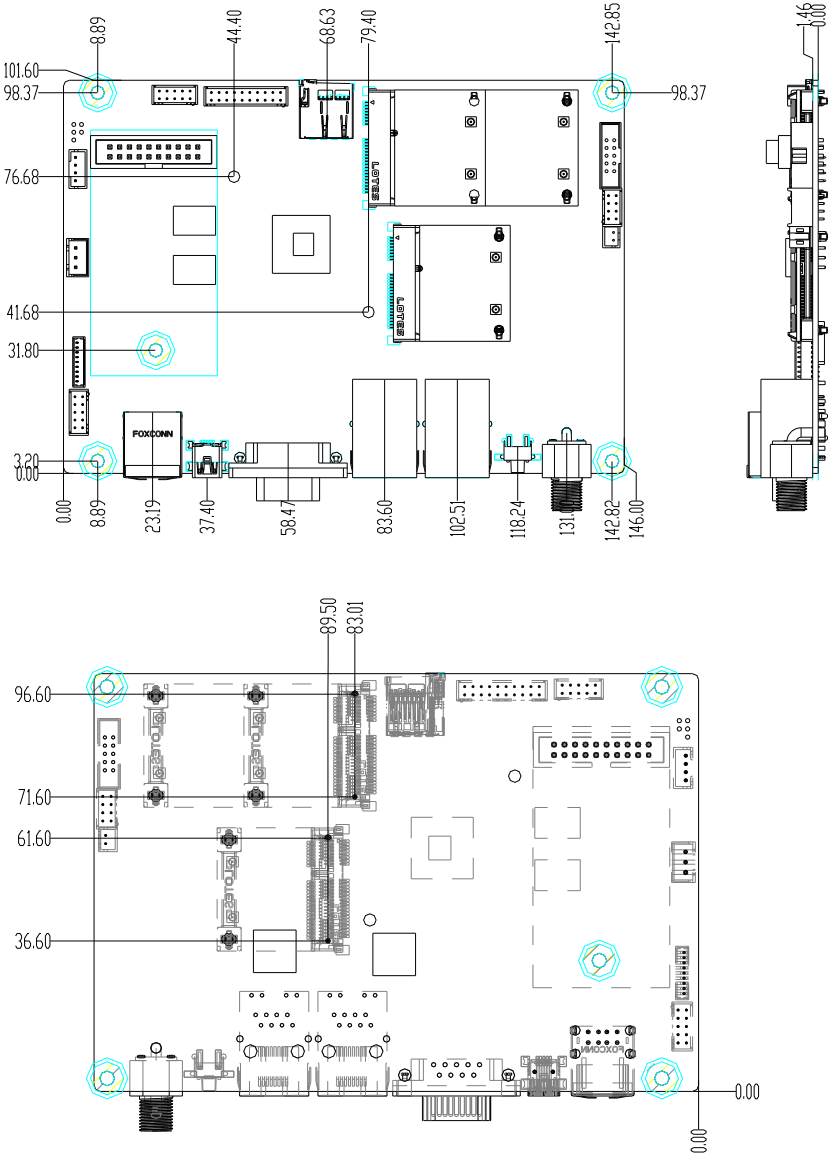

2.2 Jumpers and Connectors (Board)

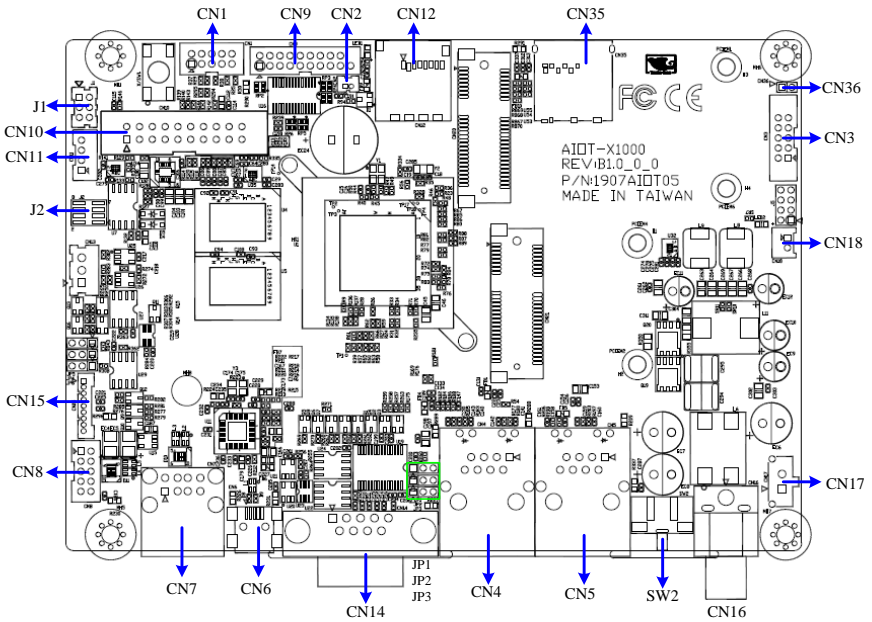

2.3 List of Jumpers

Please refer to the table below for all of the board's jumpers that you can configure for your application

Label	Function
JP1	RS-232/422/485 Selector
JP2	RS-232/422/485 Selector
JP3	RS-232/422/485 Selector

2.3.1 Serial RS-232/422/485 Selector (JP1,2,3)

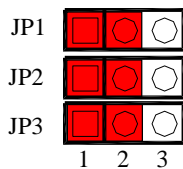

RS-232

Pin	Function
JP1 1-2	
JP2 1-2	RS-232 (Default)
JP3 1-2	

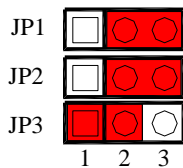

RS-422

Pin	Function
JP1 2-3	
JP2 2-3	RS-422
JP3 1-2	

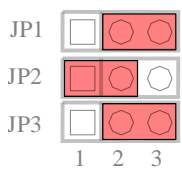

RS-485

Pin	Function
JP1 2-3	
JP2 1-2	RS-485
JP3 2-3	

2.4 List of Connectors

Please refer to the table below for all of the board's connectors that you can configure for your application

Label	Function
CN1	JTAG Programming Port Box Header
CN2	Battery Box Header
CN3	ADC Box Header
CN4	10/100 RJ-45 Connector (LAN1)
CN5	10/100 RJ-45 Connector (LAN2)
CN6	Mini USB Host Port Connector
CN7	Hub Dual USB Connector (USB1,2)
CN8	Hub Dual USB Box Header (USB3,4)
CN9	Digital I/O Box Header
CN10	ZigBee / Energy SPI Module Box Header
CN11	I2C Box Header
CN12	Micro SD Card Connector
CN14	Serial Port RS-232/422/485 Connector (COM1)
CN15	Serial Port Box Header (COM2)
CN16	DC 5V or 9V~24V Input Connector
CN17	DC 5V or 9V~24V Input Connector
CN18	Power LED Box Header
CN21	Mini PCI-E Slot
CN35	Micro SIM Socket
CN36	SD LED Header
J1	Reset
J2	SPI Flash
LED1	Micro SD LED

LED2

VCC Power OK LED

2.4.1 JTAG Programming Port Box Header (CN1)

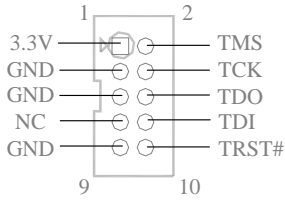

Pin	Signal	Pin	Signal
1	+3.3V	2	TMS
3	Ground	4	TCK
5	Ground	6	TDO
7	NC	8	TDI
9	Ground	10	TRST#

2.4.2 Battery Box Header (CN2)

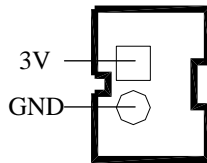

Pin	Signal
1	3V
2	Ground

2.4.3 ADC Box Header (CN3)

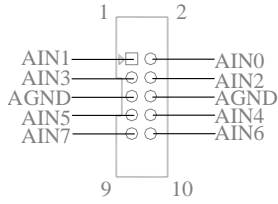

ADC Mode			
Pin	Signal	Pin	Signal
1	AIN1	2	AIN0
3	AIN3	4	AIN2
5	Analog Ground	6	Analog Ground
7	AIN5	8	AIN4
9	AIN7	10	AIN6



Pin	Signal	Pin	Signal
1	AIN1	2	AIN0
3	AIN3	4	AIN2
5	AIN5	6	AIN4

7

GND_ADC

8

AIN6

2.4.4 10/100 RJ-45 Connector (LAN1) (CN4)

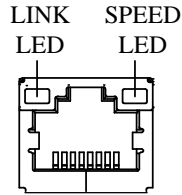

Pin	Signal	Pin	Signal
R1	LAN1_MDI-TXP	R2	LAN1_MDI-TXN
R3	LAN1_MDI-RXP	R4	LAN1_TCT
R5	NC	R6	LAN1_MDI-RXN
R7	LAN1_RCT	R8	NC
L1	LAN1_ACT-LED	L2	LAN1_ACT+LED
L3	LAN1_100-LED	L4	LAN1_100+LED

2.4.5 10/100 RJ-45 Connector (LAN2) (CN5)

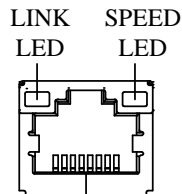

Pin	Signal	Pin	Signal
R1	LAN2_MDI-TXP	R2	LAN2_MDI-TXN

R3	LAN2_MDI-RXP	R4	LAN2_TCT
R5	NC	R6	LAN2_MDI-RXN
R7	LAN2_RCT	R8	NC
L1	LAN2_ACT-LED	L2	LAN2_ACT+LED
L3	LAN2_100-LED	L4	LAN2_100+LED

2.4.6 Mini USB Host Port Connector (CN6)

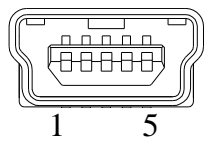

Pin	Signal
1	+5V
2	USBH0-
3	USBH0+
4	NC
5	Ground

2.4.7 Hub Dual USB Connector (USB1,2) (CN7)

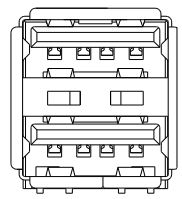

Pin	Signal	Pin	Signal
1	Ground	2	USB1+
3	USB1-	4	+5V
5	Ground	6	USB2+
7	USB2-	8	+5V

2.4.8 Hub Dual USB Box Header (USB3,4) (CN8)

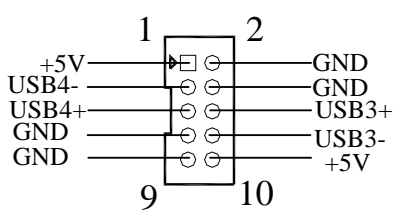

Pin	Signal	Pin	Signal
1	+5 V	2	Ground
3	USB4-	4	Ground
5	USB4+	6	USB3+
7	Ground	8	USB3-
9	Ground	10	+5 V

2.4.9 Digital I/O Box Header (CN9)

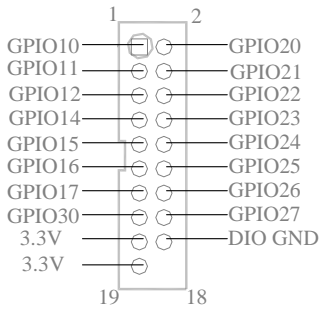

ADC Mode

Pin	Signal	Pin	Signal
1	GPIO10	2	GPIO20
3	GPIO11	4	GPIO21
5	GPIO12	6	GPIO22
7	GPIO14	8	GPIO23
9	GPIO15	10	GPIO24
11	GPIO16	12	GPIO25
13	GPIO17	14	GPIO26
15	GPIO30	16	GPIO27
17	+3.3V	18	DIO Ground
19	+3.3V		



Pin	Signal	Pin	Signal
1	DIO_GPIO10	2	DIO_GPIO20
3	DIO_GPIO11	4	DIO_GPIO21
5	DIO_GPIO12	6	DIO_GPIO22
7	DIO_GPIO14	8	DIO_GPIO23
9	GND_DIO	10	+3.3 V

2.4.10 ZigBee / Energy SPI Module Box Header (CN10)

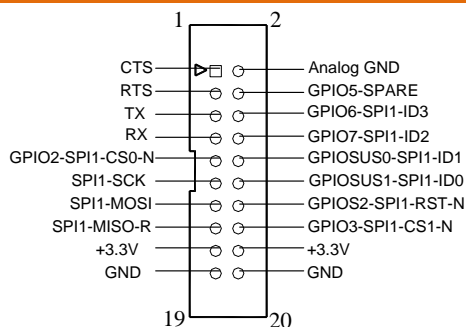

Pin	Signal	Pin	Signal
1	CTS	2	Analog Ground
3	RTS	4	GPIO5-SPARE
5	TX	6	GPIO6-SPI1-ID3
7	RX	8	GPIO7-SPI1-ID2

9	GPIO2-SPI1-CS0-N	10	GPIO2-SPI1-ID1
11	SPI1-SCK	12	GPIO2-SPI1-ID0
13	SPI1-MOSI	14	GPIO2-SPI1-RST-N
15	SPI1-MISO-R	16	GPIO3-SPI1-CS1-N
17	+3.3V	18	+3.3V
19	Ground	20	Ground

2.4.11 I2C Box Header (CN11)

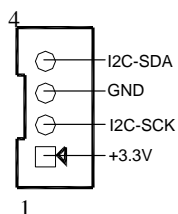

Pin	Signal
1	+3.3V
2	I2C-SCK
3	Ground
4	I2C-SDA

2.4.12 Micro SD Card Connector (CN12)

Pin	Signal	Pin	Signal
1	SD-DAT2	2	SD-DAT3
3	SD-CMD	4	+3.3V

5	SD-CLK	6	Ground
7	SD-DAT0	8	SD-DAT1

2.4.13 Serial Port RS-232/422/485 Connector (COM1) (CN14)

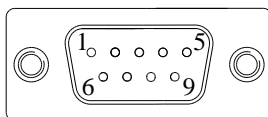

RS-232			
Pin	Signal	Pin	Signal
1	DCDAX	2	SINAX
3	SOUTAX	4	DTRAX
5	Ground	6	DSRAX
7	RTSAX	8	CTSAX
9	RIAX		

RS-422			
Pin	Signal	Pin	Signal
1	RS-422_TX-	2	RS-422_RX+
3	RS-422_TX+	4	RS-422_RX-
5	Ground	6	NC
7	NC	8	NC

9	NC		
RS-485			
Pin	Signal	Pin	Signal
1	RS485_D-	2	RS485_D+
3	NC	4	NC
5	Ground	6	NC
7	NC	8	NC
9	NC		

2.4.14 Serial Port Box Header (COM2) (CN15)

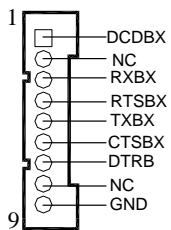

Pin	Signal	Pin	Signal
1	DCDBX	2	NC
3	RXBX	4	RTSBX
5	TXBX	6	CTSBX
7	DTRB	8	NC
9	Ground		

2.4.15 DC 5V or 9V~24V Input Connector (CN16)

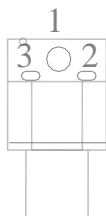

Pin	Signal
1	5V or 9V~24V
2	Ground
3	Ground

2.4.16 DC 5V or 9V~24V Input Connector (CN17)

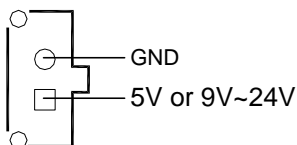

Pin	Signal
1	5V or 9V~24V
2	Ground

2.4.17 Power LED Box Header (CN18)

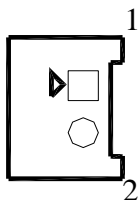

Pin	Signal
1	5V LED
2	Ground

2.4.18 Micro SIM Socket (CN35)

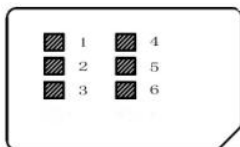

Pin	Signal	Pin	Signal
1	UIM_PWR	2	UIM_RST
3	UIM_CLK	4	GND
5	UIM_VAPP	6	UIM_DATA

2.4.19 SD LED Header (CN36)

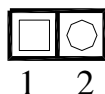

Pin	Signal
1	SD-LED
2	GND

2.4.20 LED Assignments (LED1,2)

LED	Signal
LED1	Micro-SD LED

LED2

VCC Power OK LED

2.4.21 Front Panel Connector (J1)

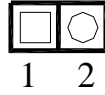

Pin	Signal
1	RESET-N
2	Ground

2.4.22 SPI JTAG Programming Port (J2)

Pin	Signal	Pin	Signal
1	+3.3V	2	Ground
3	LSPI-SS-N	4	LSPI-SCK
5	LSPI-MISO-R	6	LSPI-MOSI
7	LSPI-HOLD#	8	NC

2.5 Preloaded Drivers

Drivers for the modules listed below are preloaded with the AIOT-QG and hence no additional installations are required.

However, users still have to acquire the appropriate drivers from their respective manufacturers if modules not listed below are to be used.

- **Wifi** Intel® 6205
- **Wifi + Bluetooth** Intel® 7260
AzureWave AW-NB159H
- **3G/WCDMA/CDMA2000** Telit HE910-D
- **ZigBee** Digi XB24CZ7UIS-004