

# AIOT-ILRA01

---

LoRa<sup>®</sup> Certified Intel<sup>®</sup> Based  
Gateway and Network Server

User Manual 3<sup>rd</sup> Ed

## Copyright Notice

---

This document is copyrighted, 2018. All rights are reserved. The original manufacturer reserves the right to make improvements to the products described in this manual at any time without notice.

No part of this manual may be reproduced, copied, translated, or transmitted in any form or by any means without the prior written permission of the original manufacturer. Information provided in this manual is intended to be accurate and reliable. However, the original manufacturer assumes no responsibility for its use, or for any infringements upon the rights of third parties that may result from its use.

The material in this document is for product information only and is subject to change without notice. While reasonable efforts have been made in the preparation of this document to assure its accuracy, AAEMON assumes no liabilities resulting from errors or omissions in this document, or from the use of the information contained herein.

**AAEMON reserves the right to make changes in the product design without notice to its users.**

## Acknowledgement

---

All other products' name or trademarks are properties of their respective owners.

- Microsoft Windows is a registered trademark of Microsoft Corp.
- Intel, Pentium, Celeron, and Xeon are registered trademarks of Intel Corporation
- Core, Atom are trademarks of Intel Corporation
- ITE is a trademark of Integrated Technology Express, Inc.
- IBM, PC/AT, PS/2, and VGA are trademarks of International Business Machines Corporation.

All other product names or trademarks are properties of their respective owners.

## Packing List

---

Before setting up your product, please make sure the following items have been shipped:

Item	Quantity
● AIOT-ILRA01	1
● LoRa® Antenna	1

If any of these items are missing or damaged, please contact your distributor or sales representative immediately.

## About this Document

---

This User's Manual contains all the essential information, such as detailed descriptions and explanations on the product's hardware and software features (if any), its specifications, dimensions, jumper/connector settings/definitions, and driver installation instructions (if any), to facilitate users in setting up their product.

Users may refer to the [AAEON.com](http://AAEON.com) for the latest version of this document.

## Safety Precautions

---

Please read the following safety instructions carefully. It is advised that you keep this manual for future references

1. All cautions and warnings on the device should be noted.
2. Make sure the power source matches the power rating of the device.
3. Position the power cord so that people cannot step on it. Do not place anything over the power cord.
4. Always completely disconnect the power before working on the system's hardware.
5. No connections should be made when the system is powered as a sudden rush of power may damage sensitive electronic components.
6. If the device is not to be used for a long time, disconnect it from the power supply to avoid damage by transient over-voltage.
7. Always disconnect this device from any AC supply before cleaning.
8. While cleaning, use a damp cloth instead of liquid or spray detergents.
9. Make sure the device is installed near a power outlet and is easily accessible.
10. Keep this device away from humidity.
11. Place the device on a solid surface during installation to prevent falls
12. Do not cover the openings on the device to ensure optimal heat dissipation.
13. Watch out for high temperatures when the system is running.
14. Do not touch the heat sink or heat spreader when the system is running
15. Never pour any liquid into the openings. This could cause fire or electric shock.
16. As most electronic components are sensitive to static electrical charge, be sure to ground yourself to prevent static charge when installing the internal components. Use a grounding wrist strap and contain all electronic components in any static-shielded containers.

17. If any of the following situations arises, please the contact our service personnel:
  - i. Damaged power cord or plug
  - ii. Liquid intrusion to the device
  - iii. Exposure to moisture
  - iv. Device is not working as expected or in a manner as described in this manual
  - v. The device is dropped or damaged
  - vi. Any obvious signs of damage displayed on the device
18. **DO NOT LEAVE THIS DEVICE IN AN UNCONTROLLED ENVIRONMENT WITH TEMPERATURES BEYOND THE DEVICE'S PERMITTED STORAGE TEMPERATURES (SEE CHAPTER 1) TO PREVENT DAMAGE.**

### **Warning!**



This device complies with Part 15 FCC Rules. Operation is subject to the following two conditions: (1) this device may not cause harmful interference, and (2) this device must accept any interference received including interference that may cause undesired operation.

### **Caution:**

*There is a danger of explosion if the battery is incorrectly replaced. Replace only with the same or equivalent type recommended by the manufacturer. Dispose of used batteries according to the manufacturer's instructions and your local government's recycling or disposal directives.*

### **Attention:**

*Il y a un risque d'explosion si la batterie est remplacée de façon incorrecte. Ne la remplacer qu'avec le même modèle ou équivalent recommandé par le constructeur. Recycler les batteries usées en accord avec les instructions du fabricant et les directives gouvernementales de recyclage.*



## China RoHS Requirements (CN)

产品中有毒有害物质或元素名称及含量

AAEON Main Board/ Daughter Board/ Backplane

部件名称	有毒有害物质或元素					
	铅 (Pb)	汞 (Hg)	镉 (Cd)	六价铬 (Cr(VI))	多溴联苯 (PBB)	多溴二苯醚 (PBDE)
印刷电路板 及其电子组件	○	○	○	○	○	○
外部信号 连接器及线材	○	○	○	○	○	○

O: 表示该有毒有害物质在该部件所有均质材料中的含量均在 SJ/T 11363-2006 标准规定的限量要求以下。

X: 表示该有毒有害物质至少在该部件的某一均质材料中的含量超出 SJ/T 11363-2006 标准规定的限量要求。

备注: 此产品所标示之环保使用期限, 系指在一般正常使用状况下。

## China RoHS Requirement (EN)

Poisonous or Hazardous Substances or Elements in Products

AAEON Main Board/ Daughter Board/ Backplane

Component	Poisonous or Hazardous Substances or Elements					
	Lead (Pb)	Mercury (Hg)	Cadmium (Cd)	Hexavalent Chromium (Cr(VI))	Polybrominated Biphenyls (PBB)	Polybrominated Diphenyl Ethers (PBDE)
PCB & Other Components	○	○	○	○	○	○
Wires & Connectors for External Connections	○	○	○	○	○	○
<p>O: The quantity of poisonous or hazardous substances or elements found in each of the component's parts is below the SJ/T 11363-2006-stipulated requirement.</p> <p>X: The quantity of poisonous or hazardous substances or elements found in at least one of the component's parts is beyond the SJ/T 11363-2006-stipulated requirement.</p> <p><b>Note:</b> The Environment Friendly Use Period as labeled on this product is applicable under normal usage only</p>						

# Table of Contents

---

<b>Chapter 1 - Product Specifications</b> .....	<b>1</b>
1.1 Specifications .....	2
<b>Chapter 2 – Hardware Information</b> .....	<b>4</b>
2.1 Dimensions .....	5
2.1.1 I/O Location .....	6
2.2 Jumpers and Connectors for the UP-CHT01 .....	7
2.3 List of Switches and Connectors for the UP-CHT01 .....	8
2.3.1 Power Button (SW1).....	10
2.3.2 RTC Battery Wafer (CN1) .....	10
2.3.3 USB 3.0 Micro Connector (CN6).....	10
2.3.4 USB 2.0 x 10P Wafer (CN7).....	11
2.3.5 Dual USB Type A Connector 1 (CN8) .....	11
2.3.6 Dual USB Type A Connector 2 (CN9) .....	12
2.3.7 RJ-45 LAN Connector (CN10).....	12
2.3.8 HDMI Connector (CN11) .....	13
2.3.9 HAT 40 GPIO Connector (CN12).....	13
2.3.10 Reset Pin Header (CN14) .....	14
2.3.11 DC Jack (CN30).....	15
2.3.12 MIPI DSI Connector (CN31).....	15
2.3.13 MIPI CSI Connector (CN32) .....	16
2.3.14 Power Button Wafer (CN33) .....	17
2.3.15 Update CPLD Header (CN34) .....	17
2.4 LoRa® Module .....	18
<b>Chapter 3 –Drivers and Testing Installation</b> .....	<b>19</b>
3.1 Driver Download and Installation.....	20
3.2 Installation and Testing .....	20

# Chapter 1

---

Product Specifications

## 1.1 Specifications

---

### System

- CPU Intel® Atom™ x5-z8350 SoC
- Chipset Processor integrated
- System Memory Onboard 2GB/4GB DDR3L-1600 memory
- Power Requirement 5V DC Only
- Storage 32GB/64GB eMMC on board x 1
- Audio HDMI Audio x 1
- Power Supply Type DC-In
- Power Consumption (Typical) 5DC @ 6A
- Dimensions (L x W x H) 130 x 95 x 44.2 mm (L x W x H)
- Operating Temperature 0°C ~ 50°C (32°F ~ 122°F)
- Operation Humidity 0% ~ 90% relative humidity, non-condensing
- Certification CE Class A
- Ethernet Realtek 8111G-CG
- LoRA® function  
Frequency band 868MHz  
Sensitivity down to -138 dBm  
Tx/Rx front-ends x 2  
RF interface optimized to 50Ω  
Output power level up to 20 dBm

Range up to 15 km (Line of Sight)

## Display

- **Graphics** Intel® HD, up to 500MHz  
Support DX\*11.1/12, Open GL\*4.2, Open CL\*1.2  
OGL  
ES3.0, H.264, HEVC (decode), VP8

## I/O

- **HDMI** HDMI x 1
- **USB** USB2.0 x 4  
USB 3.0 OTG x 1
- **Expansion Slot (Optional)** RJ45 Connector x 1  
HDMI Connector x 1  
USB 2.0 Stack Connector x 2  
USB 3.0 OTG x 1  
DC connector x 1

# Chapter 2

---

Hardware Information

## 2.1 Dimensions

---

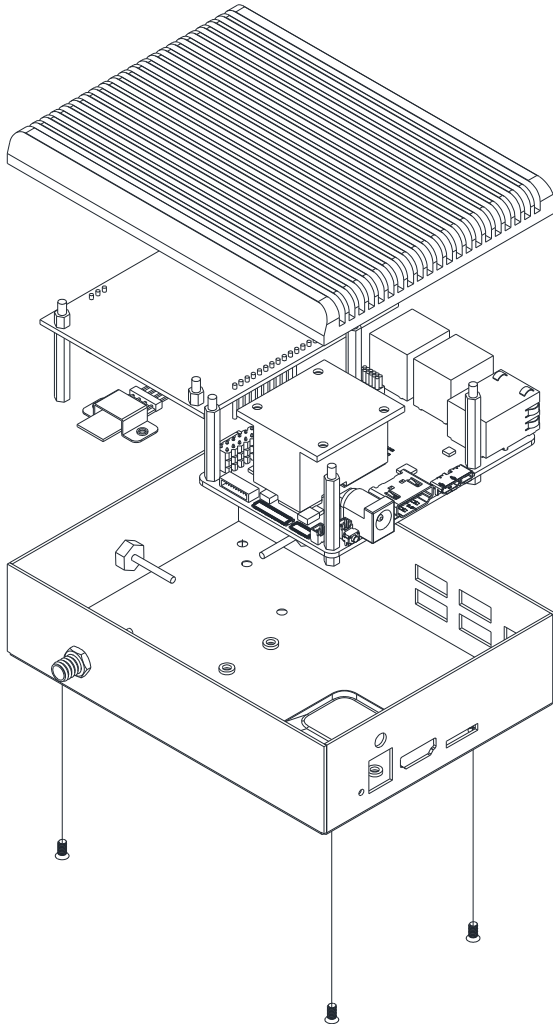



## 2.1.1 I/O Location

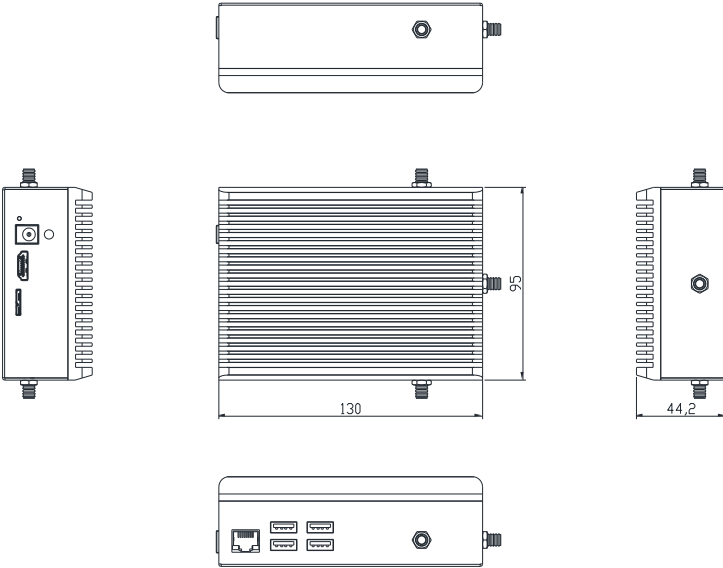

## 2.2 Jumpers and Connectors for the UP-CHT01

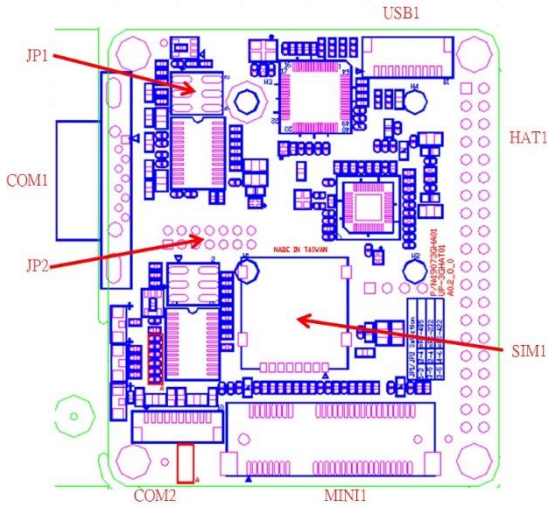
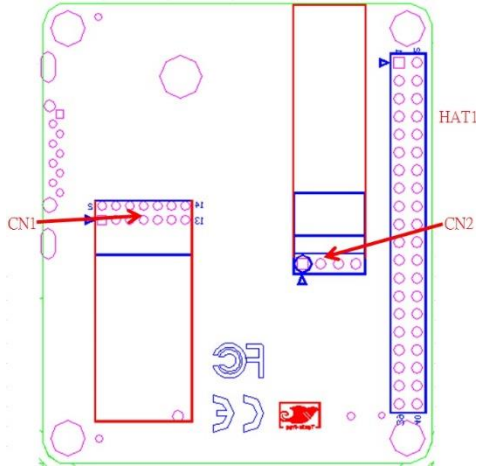

## 2.3 List of Switches and Connectors for the UP-CHT01

---

Please refer to the table below for all of the board's jumpers that you can configure for your application.

Label	Function
SW1	Power Button
CN1	RTC Battery Wafer
CN6	USB 3.0 Micro Connector
CN7	USB 2.0 1x10P Wafer
CN8	USB Type A Connector 1
CN9	USB Type A Connector 2
CN10	RJ45 LAN Connector
CN11	HDMI Connector
CN12	HAT 40 GPIO Connector
CN14	Reset Pin Header
CN30	DC Jack
CN31	MIPI DSI Connector
CN32	MIPI CSI Connector
CN33	Power Button Wafer
CN34	Update CPLD Header

Label	Connector Type
SW1	(TF) Push Button Switch.HCH.PTS-099
CN1	(TF) WAFER BOX 2P:180D.1.25mm.CATCH.1201-700-02S
CN6	(TF) Micro USB 3.0 Conn.10P:90D.B-type.ATTEND.209E-BE01
CN7	(TF)Wafer Box.10P:90D.1.0mm.CATCH.1204-700-10RM
CN8	(TF)USB CONNECTOR DUAL PORT.8P:TechBest.KS-002D-ANB(2.0)-L
CN9	(TF)USB CONNECTOR DUAL PORT.8P:TechBest.KS-002D-ANB(2.0)-L
CN10	(TF) RJ45.14P:90D.W/TF & LED.UDE.RB1-1A5BAK1A
CN11	(TF)HDMI CONN.19P:90D(F).A TYPE.FOXCONN.QJ51191-LFB4-7F
CN12	(TF) PIN HEADER.2*20P:180D.(M).2.54mm.DIP
CN14	(TF) PIN HEADER.2*1P:180D.(M).2.0mm.DIP
CN30	(TF)DC Power Jack.3P:90D(M).DIP.2.0mm.COXOC.416AEWTJ02004PA
CN31	(TF)FPC/FFC Conn.41P:90D(F).0.6mm.Hirose.FH35C-41S-0.3SHW(50)
CN32	(TF)FPC/FFC Conn.21P:90D(F).0.6mm.Hirose.FH35C-21S-0.3SHW(50)
CN33	(TF)WAFER BOX.2P:180D.(M).1.25mm.CATCH.1201-700-02S
CN34	(TF)PIN HEADER.6*2P:180D(M).1.27mm.Astron.C27-4112-206-1G-R

### 2.3.1 Power Button (SW1)

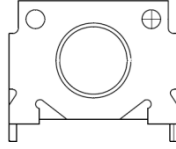

Position	Function
SW1 1	(default)
SW1 0	Power on

### 2.3.2 RTC Battery Wafer (CN1)

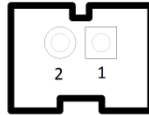

Pin	Signal
1	+V_COIN_BAT
2	GND

### 2.3.3 USB 3.0 Micro Connector (CN6)

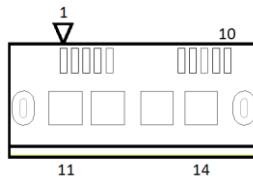

Pin	Signal	Pin	Signal
1	USB_VCC	8	GND
2	USB2_D-	9	CROSSBAR_TX1_N
3	USB2_D+	10	CROSSBAR_TX1_P
4	USB2_ID	11	GND

5	GND	12	GND
6	CROSSBAR_RX1_N	13	GND
7	CROSSBAR_RX1_P	14	GND

### 2.3.4 USB 2.0 x 10P Wafer (CN7)

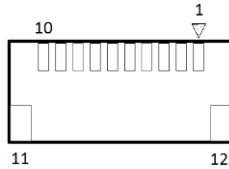

Pin	Signal	Pin	Signal
1	USB_VCC	7	USB_HSIC_P4_D+
2	USB_HSIC_P3_D-	8	GND
3	USB_HSIC_P3_D+	9	UART0_RXD
4	GND	10	UART0_TXD
5	USB_VCC	11	GND
6	USB_HSIC_P4_D-	12	GND

### 2.3.5 Dual USB Type A Connector 1 (CN8)

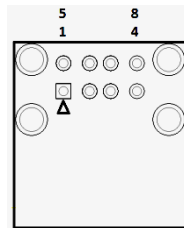

Pin	Signal	Pin	Signal
1	USB_VCC	5	USB_VCC

2	USB2_P1_D-	6	USB2_P2_D-
3	USB2_P1_D+	7	USB2_P2_D+
4	GND	8	GND

### 2.3.6 Dual USB Type A Connector 2 (CN9)

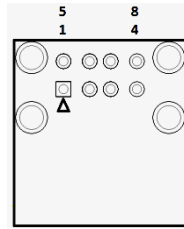

Pin	Signal	Pin	Signal
1	USB_VCC	5	USB_VCC
2	USB2_P3_D-	6	USB_HSIC_P2_D-
3	USB2_P3_D+	7	USB_HSIC_P2_D+
4	GND	8	GND

### 2.3.7 RJ-45 LAN Connector (CN10)

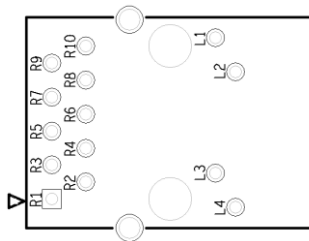

Pin	Signal	Pin	Signal
R1	LAN1_MDI0+	R8	LAN1_MDI2-
R2	LAN1_MDI0-	R9	LAN1_MDI3+

R3	LAN1_MDI1+	R10	LAN1_MDI3-
R4	LAN1_MDI1-	L1	LAN_ACTLEDP
R5	LAN1_MDI2+	L2	LAN_ACTLEDN
R6	LAN1_MDI2-	L3	LAN_LINK100#
R7	LAN1_MDI2+	L4	LAN_LINK1000#

### 2.3.8 HDMI Connector (CN11)

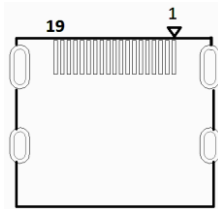

Pin	Signal	Pin	Signal
1	DDI2_TX0_HDMI_DP+	11	GND
2	GND	12	DDI2_CLK_HDMI_DN-
3	DDI2_TX0_HDMI_DN-	13	HDMI_CEC_D
4	DDI2_TX1_HDMI_DP+	14	NC
5	GND	15	DDI2_DDC_CLK
6	DDI2_TX1_HDMI_DN-	16	DDI2_DDC_DAT
7	DDI2_TX2_HDMI_DP+	17	GND
8	GND	18	+5V_HDMI
9	DDI2_TX2_HDMI_DN-	19	DDI2_TYPE_C_HPDI
10	DDI2_CLK_HDMI_DP+		

### 2.3.9 HAT 40 GPIO Connector (CN12)

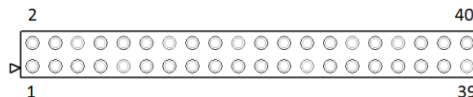



Pin	Signal	Pin	Signal
1	+3.3V	2	+5V
3	I2C1_SDA	4	+5V
5	I2C1_SCL	6	GND
7	ISH_GPIO0	8	UART_TX
9	GND	10	UART_RX
11	SD2_CMD	12	I2S2_CLK
13	SD2_CLK	14	GND
15	SD2_SD0	16	SD2_SD1
17	+3.3V	18	SD2_SD2
19	SPI2_MOSI	20	GND
21	SPI2_MISO	22	SD2_SD3
23	SPI2_CLK	24	ISH_SPI2_CS0
25	GND	26	ISH_SPI2_CS1
27	I2C0_SDA	28	I2C0_SCL
29	ISH_GPIO2	30	GND
31	ISH_GPIO3	32	PWM0
33	PWM1	34	GND
35	I2S2_FRM	36	GPIO27
37	GPIO13	38	I2S2_RX
39	GND	40	I2S2_TX

### 2.3.10 Reset Pin Header (CN14)

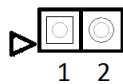

Pin	Signal
1	PMU_RSTBTN_N
2	GND

### 2.3.11 DC Jack (CN30)

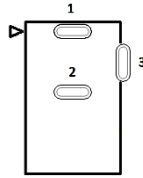

Pin	Signal
1	+V5
2	GND
3	GND

### 2.3.12 MIPI DSI Connector (CN31)

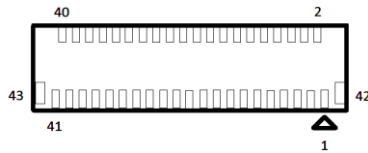

Pin	Signal	Pin	Signal	Pin	Signal
1	MDSI_A_DATA1_DN	16	DDI0_TX0_DP	31	DDI0_HPD_CONN
2	MDSI_A_DATA1_DP	17	DDI0_TX0_DN	32	DDI0_BKLT_R_CTRL
3	GND	18	GND	33	DDI0_VDD_EN
4	MDSI_A_CLK_DN	19	DDI0_TX1_DP	34	DDI0_BKLT_EN
5	MDSI_A_CLK_DP	20	DDI0_TX1_DN	35	NC
6	GND	21	GND	36	NC
7	MDSI_A_DATA0_DN	22	DDI0_TX2_DP	37	+3.3V
8	MDSI_A_DATA0_DP	23	DDI0_TX2_DN	38	+3.3V
9	GND	24	GND	39	+3.3V
10	I2C2_3P3_SCL	25	DDI0_TX3_DP	40	+3.3V

11	I2C2_3P3_SDA	26	DDI0_TX3_DN	41	+3.3V
12	GND	27	GND	42	GND
13	DDI1_DDC_C_CLK	28	DDI0_AUX_DP	43	GND
14	DDI1_DDC_C_DAT	29	DDI0_AUX_DN		
15	GND	30	GND		

### 2.3.13 MIPI CSI Connector (CN32)

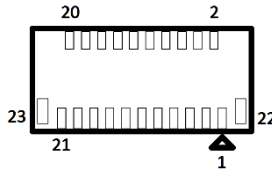

Pin	Signal	Pin	Signal
1	GND	13	GND
2	MCSI_1_DATA1_DN	14	CAM_MCLK
3	MCSI_1_DATA1_DP	15	GND
4	GND	16	I2C2_SOC_SCL
5	MCSI_1_CLK_DN	17	I2C2_SOC_SDA
6	MCSI_1_CLK_DP	18	CAM_RST_N
7	GND	19	FLASH_RESET_N
8	MCSI_1_DATA0_DN	20	+2.8V
9	MCSI_1_DATA0_DP	21	GND_CAM
10	GND	22	GND
11	+1.2V	23	GND
12	+1.8V		

### 2.3.14 Power Button Wafer (CN33)

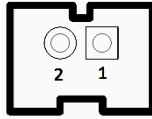

Pin	Signal
1	PWR_SW#_CTL_R
2	GND

### 2.3.15 Update CPLD Header (CN34)

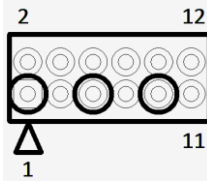

Pin	Signal	Pin	Signal
1	CHT_GPIO_TMS	2	CPLD_TMS
3	CHT_GPIO_TDI	4	CPLD_TDI
5	CHT_GPIO_TCK	6	CPLD_TCK
7	CHT_GPIO_TDO	8	CPLD_TDO
9	FAN_PWM	10	+1.8V
11	+5V	12	GND

## 2.4 LoRa® Module

---

Has been outsourced.

# Chapter 3

---

Drivers and Testing Installation

## 3.1 Driver Download and Installation

---

\* Please access the <https://up-community.org> and go to the Downloads section>UP to find the relevant driver.

## 3.2 Installation and Testing

---

### 1. Modify the Vanilla HAL Software:

#### **Step 1.** Decompress the HAL software

```
$ unzip ~/unzip lora_gateway-master.zip
```

```
$ unzip ~/packet_forwarder-master.zip
```

#### **Step 2.** Modify the HAL

```
$ cd ~/lora_gateway-master/libloragw/src/
```

```
$ vim loragw_spi.native.c
```

Replace

```
#define SPI_DEV_PATH "/dev/spidev0.0"
```

with

```
#define SPI_DEV_PATH "/dev/spidev2.0"
```

#### **Step 3.** Modify the Reset-Script

```
$ cd ~/lora_gateway-master/
```

```
$ vim reset_lgw.sh
```

Replace

```
IOT_SK_SX1301_RESET_PIN=7
```

with

```
IOT_SK_SX1301_RESET_PIN=5
```

#### **Step 4.** Build the HAL software

```
$ cd ~/lora_gateway-master/
```

```
$ make clean && make
```

## 2. Testing

### **Test 1.** Basic low level SPI test

```
$ cd ~/lora_gateway-master/
```

```
$ sudo ./reset_lgw.sh start
```

```
$ cd util_spi_stress/
```

```
$ ./util_spi_stress
```



```

aaeon@ubinux:~$ cd ~/lora_gateway-master/
aaeon@ubinux:~/lora_gateway-master$ sudo ./reset_lgw.sh start
[sudo] password for aaeon:
aaeon@ubinux:~/lora_gateway-master$ cd util_spi_stress/
aaeon@ubinux:~/lora_gateway-master/util_spi_stress$ ./util_spi_stress
INFO: Starting LoRa concentrator SPI stress-test number 1
Cycle 0 > did 1000 R/W on an 8 bits reg with no error
Cycle 1 > did 1000 R/W on an 8 bits reg with no error
Cycle 2 > did 1000 R/W on an 8 bits reg with no error
Cycle 3 > did 1000 R/W on an 8 bits reg with no error
Cycle 4 > did 1000 R/W on an 8 bits reg with no error
Cycle 5 > did 1000 R/W on an 8 bits reg with no error
Cycle 6 > did 1000 R/W on an 8 bits reg with no error
Cycle 7 > did 1000 R/W on an 8 bits reg with no error
Cycle 8 > did 1000 R/W on an 8 bits reg with no error
Cycle 9 > did 1000 R/W on an 8 bits reg with no error
Cycle 10 > did 1000 R/W on an 8 bits reg with no error

```

## Test 2. Simple TX test

```
$ cd ~/lora_gateway-master/
```

```
$ sudo ./reset_lgw.sh start
```

```
$ cd util_tx_test/
```

```
$ ./util_tx_test -r1257 -f868.1 -s7 -p0 -t100 -x10
```

```

aaeon@ubinux:~$ cd ~/lora_gateway-master/
aaeon@ubinux:~/lora_gateway-master$ sudo ./reset_lgw.sh start
aaeon@ubinux:~/lora_gateway-master$ cd util_tx_test/
aaeon@ubinux:~/lora_gateway-master/util_tx_test$ ./util_tx_test -r1257 -f868.1 -s7 -p0 -t100 -x10
Sending 10 LoRa packets on 868100000 Hz (BW 125 kHz, SF 7, CR 1, 16 bytes payload, 8 symbols preamble) at 0 dBm, with 100 ms between each
INFO: concentrator started, packet can be sent
Sending packet number 1 ...OK
Sending packet number 2 ...OK
Sending packet number 3 ...OK
Sending packet number 4 ...OK
Sending packet number 5 ...OK
Sending packet number 6 ...OK
Sending packet number 7 ...OK
Sending packet number 8 ...OK
Sending packet number 9 ...OK
Sending packet number 10 ...OK
Exiting LoRa concentrator TX test program

```

## Test 3. Simple RX test

```
$ cd ~/lora_gateway-master/
```

```
$ sudo ./reset_lgw.sh start
```

```
$ cd util_pkt_logger/
```

```
$ ./util_pkt_logger
```

```
aaeon@ubilinux:~$ cd ~/lora_gateway-master/
aaeon@ubilinux:~/lora_gateway-master$ sudo ./reset_lgw.sh start
aaeon@ubilinux:~/lora_gateway-master$ cd util_pkt_logger/
aaeon@ubilinux:~/lora_gateway-master/util_pkt_logger$ ./util_pkt_logger
loragw_pkt_logger: INFO: found global configuration file global_conf.json, trying to parse it
loragw_pkt_logger: INFO: global_conf.json does contain a JSON object named SX1301_conf, parsing SX1301 parameters
loragw_pkt_logger: INFO: lorawan_public 1, clksrc 1
loragw_pkt_logger: INFO: radio 0 enabled (type SX1257), center frequency 867500000, RSSI offset -166.000000, tx enabled 0, tx_notch_freq 0
loragw_pkt_logger: INFO: radio 1 enabled (type SX1257), center frequency 868500000, RSSI offset -166.000000, tx enabled 0, tx_notch_freq 0
loragw_pkt_logger: INFO: LoRa multi-SF channel 0 enabled, radio 1 selected, IF -400000 Hz, 125 kHz bandwidth, SF 7 to 12
loragw_pkt_logger: INFO: LoRa multi-SF channel 1 enabled, radio 1 selected, IF -200000 Hz, 125 kHz bandwidth, SF 7 to 12
loragw_pkt_logger: INFO: LoRa multi-SF channel 2 enabled, radio 1 selected, IF 0 Hz, 125 kHz bandwidth, SF 7 to 12
loragw_pkt_logger: INFO: LoRa multi-SF channel 3 enabled, radio 0 selected, IF -400000 Hz, 125 kHz bandwidth, SF 7 to 12
loragw_pkt_logger: INFO: LoRa multi-SF channel 4 enabled, radio 0 selected, IF -200000 Hz, 125 kHz bandwidth, SF 7 to 12
loragw_pkt_logger: INFO: LoRa multi-SF channel 5 enabled, radio 0 selected, IF 0 Hz, 125 kHz bandwidth, SF 7 to 12
loragw_pkt_logger: INFO: LoRa multi-SF channel 6 enabled, radio 0 selected, IF 200000 Hz, 125 kHz bandwidth, SF 7 to 12
loragw_pkt_logger: INFO: LoRa multi-SF channel 7 enabled, radio 0 selected, IF 400000 Hz, 125 kHz bandwidth, SF 7 to 12
loragw_pkt_logger: INFO: LoRa standard channel enabled, radio 1 selected, IF -200000 Hz, 250000 Hz bandwidth, SF 7
loragw_pkt_logger: INFO: FSK channel enabled, radio 1 selected, IF 300000 Hz, 125000 Hz bandwidth, 50000 bps datarate
loragw_pkt_logger: INFO: global_conf.json does contain a JSON object named gateway_conf, parsing gateway parameters
loragw_pkt_logger: INFO: gateway MAC address is configured to AA555A0000000000
loragw_pkt_logger: INFO: found local configuration file local_conf.json, trying to parse it
loragw_pkt_logger: INFO: local_conf.json does not contain a JSON object named SX1301_conf
loragw_pkt_logger: INFO: local_conf.json does contain a JSON object named gateway_conf, parsing gateway parameters
loragw_pkt_logger: INFO: gateway MAC address is configured to AA555A0000000101
loragw_pkt_logger: INFO: concentrator started, packet can now be received
loragw_pkt_logger: INFO: Now writing to log file pktlog_AA555A0000000101_20170323T072724Z.csv
^C
loragw_pkt_logger: INFO: concentrator stopped successfully
loragw_pkt_logger: INFO: log file pktlog_AA555A0000000101_20170323T072724Z.csv closed, 1 packet(s) recorded
loragw_pkt_logger: INFO: Exiting packet logger program
```

#### Test 4. Testing the forwarder

```
$ cd ~/packet_forwarder-master/
```

```
$ vim Makefile
```

Replace

```
LGW_PATH ?= ../lora_gateway/libloragw
```

with

LGW\_PATH ?=

/home/USERNAME/lora\_gateway-master/libloragw

\$ make clean && make Open two terminal

**Terminal 1** (virtual server):

\$ cd ~/lora\_gateway-master/

\$ sudo ./reset\_lgw.sh start

\$ cd ~/packet\_forwarder-master/util\_sink/

\$ ./util\_sink 1680

**Terminal 2:**

\$ cd ~/packet\_forwarder-master/lora\_pkt\_fwd/

\$ ./lora\_pkt\_fwd

```

saeon@ubuntu:~$ cd ~/lora_gateway-master/
saeon@ubuntu:~/lora_gateway-master$ sudo ./reset_lgw.sh start
saeon@ubuntu:~/lora_gateway-master$ cd util_pkt_logger/
saeon@ubuntu:~/lora_gateway-master/util_pkt_logger$ ./util_pkt_logger
loragw_pkt_logger: INFO: found global configuration file global_conf.json, trying to parse it
loragw_pkt_logger: INFO: global_conf.json does contain a JSON object named SX1301_conf, parsing SX1301 parameters
loragw_pkt_logger: INFO: lorawan_public 1, clksc 1
loragw_pkt_logger: INFO: radio 0 enabled (type SX1257), center frequency 867500000, RSSI offset -166.000000, tx enabled 0, tx_notch_freq 0
loragw_pkt_logger: INFO: radio 1 enabled (type SX1257), center frequency 868500000, RSSI offset -166.000000, tx enabled 0, tx_notch_freq 0
loragw_pkt_logger: INFO: LoRa multi-SF channel 0 enabled, radio 1 selected, IF -400000 Hz, 125 kHz bandwidth, SF 7 to 12
loragw_pkt_logger: INFO: LoRa multi-SF channel 1 enabled, radio 1 selected, IF -200000 Hz, 125 kHz bandwidth, SF 7 to 12
loragw_pkt_logger: INFO: LoRa multi-SF channel 2 enabled, radio 1 selected, IF 0 Hz, 125 kHz bandwidth, SF 7 to 12
loragw_pkt_logger: INFO: LoRa multi-SF channel 3 enabled, radio 0 selected, IF -400000 Hz, 125 kHz bandwidth, SF 7 to 12
loragw_pkt_logger: INFO: LoRa multi-SF channel 4 enabled, radio 0 selected, IF -200000 Hz, 125 kHz bandwidth, SF 7 to 12
loragw_pkt_logger: INFO: LoRa multi-SF channel 5 enabled, radio 0 selected, IF 0 Hz, 125 kHz bandwidth, SF 7 to 12
loragw_pkt_logger: INFO: LoRa multi-SF channel 6 enabled, radio 0 selected, IF 200000 Hz, 125 kHz bandwidth, SF 7 to 12
loragw_pkt_logger: INFO: LoRa multi-SF channel 7 enabled, radio 0 selected, IF 400000 Hz, 125 kHz bandwidth, SF 7 to 12
loragw_pkt_logger: INFO: LoRa standard channel enabled, radio 1 selected, IF -200000 Hz, 250000 Hz bandwidth, SF 7
loragw_pkt_logger: INFO: FSK channel enabled, radio 1 selected, IF 300000 Hz, 125000 Hz bandwidth, 50000 bps datarate
loragw_pkt_logger: INFO: global_conf.json does contain a JSON object named gateway_conf, parsing gateway parameters
loragw_pkt_logger: INFO: gateway MAC address is configured to AA55A00000000000
loragw_pkt_logger: INFO: found local configuration file local_conf.json, trying to parse it
loragw_pkt_logger: INFO: local_conf.json does not contain a JSON object named SX1301_conf
loragw_pkt_logger: INFO: local_conf.json does contain a JSON object named gateway_conf, parsing gateway parameters
loragw_pkt_logger: INFO: gateway MAC address is configured to AA55A00000000101
loragw_pkt_logger: INFO: concentrator started, packet can now be received
loragw_pkt_logger: INFO: Now writing to log file pktlog_AA55A00000000101_20170323T072724Z.csv
loragw_pkt_logger: INFO: concentrator stopped successfully
loragw_pkt_logger: INFO: log file pktlog_AA55A00000000101_20170323T072724Z.csv closed, 1 packet(s) recorded
loragw_pkt_logger: INFO: Exiting packet logger program

```

## Test 5. Test with Mote II

**Step 1.** Power up Mote II

**Step 2.** Start the packet forwarder

```
$ cd ~/lora_gateway-master/
```

```
$ sudo ./reset_lgw.sh start
```

```
$ cd ~/packet_forwarder-master/lora_pkt_fwd/
```

```
$ ./lora_pkt_fwd
```

### Step 3. You can get pkt from Mote II on terminal

```
INFO: Received pkt from mote: 011FCDE6 (fcnt=1)
JSON up: {"rxpk":{"tmst":10674436,"chan":2,"rfch":1,"freq":868.500000,"stat":1,"modu":"LORA","datr":"SF12BW125","codr":"4/5","lsnr":6.8,"rssi":-4,"size":29,"data":"Q0bNHwEAAQACGBVCX6N67b+RcnsYxGwxXtuWgIs="}}
```

Mote II:

