

**AHP-2176**

Onboard Intel® Celeron® 827E  
1.4GHz Processor  
Touch Panel PC  
With 17" TFT LCD

## Copyright Notice

This document is copyrighted, 2014. All rights are reserved. The original manufacturer reserves the right to make improvements to the products described in this manual at any time without notice.

No part of this manual may be reproduced, copied, translated, or transmitted in any form or by any means without the prior written permission of the original manufacturer. Information provided in this manual is intended to be accurate and reliable. However, the original manufacturer assumes no responsibility for its use, or for any infringements upon the rights of third parties that may result from its use.

The material in this document is for product information only and is subject to change without notice. While reasonable efforts have been made in the preparation of this document to assure its accuracy, AAEON assumes no liabilities resulting from errors or omissions in this document, or from the use of the information contained herein.

AAEON reserves the right to make changes in the product design without notice to its users.

## Acknowledgments

All other products' name or trademarks are properties of their respective owners.

- AMI is a trademark of American Megatrends Inc.
- Intel<sup>®</sup>, and Atom<sup>™</sup> are trademarks of Intel<sup>®</sup> Corporation.
- Microsoft Windows<sup>®</sup> is a registered trademark of Microsoft Corp.
- IBM, PC/AT, PS/2, and VGA are trademarks of International Business Machines Corporation.

All other product names or trademarks are properties of their respective owners.

## Packing List

Before you begin operating your PC, please make sure that the following materials are enclosed:

- AHP-2176 Touch Panel PC
- Mounting brackets and screws
- DVD-ROM for manual (in PDF format) and drivers

If any of these items should be missing or damaged, please contact your distributor or sales representative immediately.

## Safety & Warranty

1. Read these safety instructions carefully.
2. Keep this user's manual for later reference.
3. Disconnect this equipment from any AC outlet before cleaning. Do not use liquid or spray detergents for cleaning. Use a damp cloth.
4. For pluggable equipment, the power outlet must be installed near the equipment and must be easily accessible.
5. Keep this equipment away from humidity.
6. Put this equipment on a firm surface during installation. Dropping it or letting it fall could cause damage.
7. The openings on the enclosure are for air convection. Protect the equipment from overheating. **DO NOT COVER THE OPENINGS.**
8. Make sure the voltage of the power source is correct before connecting the equipment to the power outlet.
9. Position the power cord so that people cannot step on it. Do not place anything over the power cord.
10. All cautions and warnings on the equipment should be noted.
11. If the equipment is not used for a long time, disconnect it from the power source to avoid damage by transient over-voltage.
12. Never pour any liquid into an opening. This could cause fire or electrical shock.
13. Never open the equipment. For safety reasons, only qualified service personnel should open the equipment.
14. If any of the following situations arises, get the equipment checked by service personnel:
  - a. The power cord or plug is damaged.
  - b. Liquid has penetrated into the equipment.
  - c. The equipment has been exposed to moisture.

- d. The equipment does not work well, or you cannot get it to work according to the user's manual.
  - e. The equipment has been dropped and damaged.
  - f. The equipment has obvious signs of breakage.
15. DO NOT LEAVE THIS EQUIPMENT IN AN ENVIRONMENT WHERE THE STORAGE TEMPERATURE IS BELOW -20°C (-4°F) OR ABOVE 60°C (140°F). IT MAY DAMAGE THE EQUIPMENT.
16. RESTRICTED ACCESS LOCATION: location for equipment where both of the following apply:
- a. access can only be gained by SERVICE PERSONS or by USERS who have been instructed about the reasons for the restrictions applied to the location and about any precautions that shall be taken; and
  - b. access is through the use of a TOOL or lock and key, or other means of security, and is controlled by the authority responsible for the location
17. Caution: There is a danger of explosion if the battery is incorrectly replaced. Replace only with the same or equivalent type recommended by the manufacturer. Dispose of used batteries according to the manufacturer's instructions and your local government's recycling or disposal directives.

***Attention:***

Il y a un risque d'explosion si la batterie est remplacée de façon incorrecte. Ne la remplacer qu'avec le même modèle ou équivalent recommandé par le constructeur. Recycler les batteries usées en accord avec les instructions du fabricant et les directives gouvernementales de recyclage.

## FCC

***Warning!***



This device complies with Part 15 FCC Rules. Operation is subject to the following two conditions: (1) this device may not cause harmful interference, and (2) this device must accept any interference received including interference that may cause undesired operation.

Below Table for China RoHS Requirements  
 产品中有毒有害物质或元素名称及含量  
 AAEON Panel PC/ Workstation

部件名称	有毒有害物质或元素					
	铅 (Pb)	汞 (Hg)	镉 (Cd)	六价铬 (Cr(VI))	多溴联苯 (PBB)	多溴二苯醚 (PBDE)
印刷电路板 及其电子组件	×	○	○	○	○	○
外部信号 连接器及线材	×	○	○	○	○	○
外壳	×	○	○	○	○	○
中央处理器 与内存	×	○	○	○	○	○
硬盘	×	○	○	○	○	○
液晶模块	×	○	○	○	○	○
光驱	×	○	○	○	○	○
触控模块	×	○	○	○	○	○
电源	×	○	○	○	○	○
<p><b>O:</b> 表示该有毒有害物质在该部件所有均质材料中的含量均在  <b>SJ/T 11363-2006</b> 标准规定的限量要求以下。</p> <p><b>X:</b> 表示该有毒有害物质至少在该部件的某一均质材料中的含量超出  <b>SJ/T 11363-2006</b> 标准规定的限量要求。</p> <p>备注：            一、此产品所标示之环保使用期限，系指在一般正常使用状况下。            二、上述部件物质中央处理器、内存、硬盘、光驱、触控模块为选购品。</p>						



# Contents

## Chapter 1 General Information

1.1 Introduction.....	1-2
1.2 Specification .....	1-3
1.3 Dimension .....	1-6

## Chapter 2 Hardware Installation

2.1 Panelmount Installation .....	2-2
2.2 Hard Disk Drive Installation .....	2-4

## Chapter 3 AMI BIOS Setup

3.1 System Test and Initialization .....	3-2
3.2 AMI BIOS Setup .....	3-3

## Chapter 4 Driver Installation

4.1 Introduction.....	4-3
-----------------------	-----

## Appendix A Programming the Watchdog Timer

A.1 Watchdog Timer Initial Program .....	A-2
--	-----

## Appendix B I/O Information

B.1 I/O Address Map .....	B-2
B.2 Memory Address Map .....	B-4
B.3 IRQ Mapping Chart .....	B-5
B.4 DMA Channel Assignments .....	B-7

Chapter

1

**General  
Information**

## 1.1 Introduction

---

The AHP-2176 operator panel is an onboard Intel® Celeron® 827E 1.4GHz processor computer that is designed to serve as a human machine interface (HMI). It is a PC-based system with 17" color TFT LCD display, onboard Ethernet controller, multi-COM port interfaces and an audio controller. With a built-in CFast™ socket, the AHP-2176 is as compact and user friendly as a multi-function computer. In addition, its "fit anywhere" design makes it very flexible and able to be used in many different kinds of installations. It can be Panel / VESA / Wallmounted.

For system integrators, this simple, complete, compact and highly integrated system let you easily build an operator panel into your applications. Common industrial applications include factory automation systems, precision machinery, and production process control. It is also suitable for many non-industrial applications, including vending machine, and car park automation. Our operator panel is a reliable, cost-effective solution to your application's processing requirements.

## 1.2 Specification

---

### System

- CPU Onboard Intel® Celeron® 827E 1.4GHz Processor
- System Memory DDR3 800/1066/1333 MHz (204 pin) x 2, SODIMM, Max. 8GB
- Ethernet 10/100/1000Base-T, RJ-45 x 2
- LCD / CRT Controller Integrated in Processor
- I/O Port  
USB2.0 x 4 (2 on front, 2 on rear)  
DB-9 RS-232 x 4 (COM3/4/5/6)  
LAN x 2  
VGA x 1  
Line-out x 1  
Power switch x 1
- Storage Disk Drive CFAST™ slot x 1 (Internal);  
2.5" SATA Hard Disk Drive x 1
- Expansion Slot Mini PCIe Card x 2
- OS Support Windows® CE, Windows® XP,  
Windows® XP embedded, Windows® 7,  
linux kernel 2.6.3 or above

### Mechanical

- Construction IP-65 aluminum die cast front bezel
- Mounting Panel/ Wall/ VESA 100/ Desktop

- Dimension 16.5"(W) x 14.1"(H) x 2.8"(D) (420mm x 358mm x 97mm)
- Carton Dimension 26"(W) x 8.11"(H) x 19.53"(D) (661mm x 206mm x 496mm)
- Net Weight 17.9 lb (8.1 kg)
- Gross Weight 23.1 lb (10.5 kg)

### **Environmental**

- Operating Temperature -4°F~-140°F (-20°C~60°C)
- Storage Temperature -4°F~-158°F (-20°C~70°C)
- Operating Humidity 5% to 95% @ 40°C, non-condensing
- Vibration 1 g rms/ 5-500Hz/ Operation (HDD)
- Shock 20 G peak acceleration (11 msec. duration)
- EMC CE/FCC Class A
- Power Supply 9~30V DC input ;  
Over-voltage protection  
Low-voltage protection  
Reverse protection

### **Power Supply**

- DC Input 9~30V DC input ;  
Over-voltage protection  
Low-voltage protection  
Reverse protection

**LCD**

- Display Type 17" TFT LCD
- Max. Resolution 1280x1024
- Max. Colors 16.7M colors
- Luminance (cd/m<sup>2</sup>) HTT : 350
- Viewing Angle HTT: 170° (H),160° (V)
- Backlight LED
- Backlight MTBF (Hours) HTT : 50,000

**Touch Screen**

- Type 5-wire analog resistive
- Resolution 2048x2048
- Light Transmission > 80%
- Lifetime 35 million activations

### 1.3 Dimension

AHP- 2176

UNITS:m m

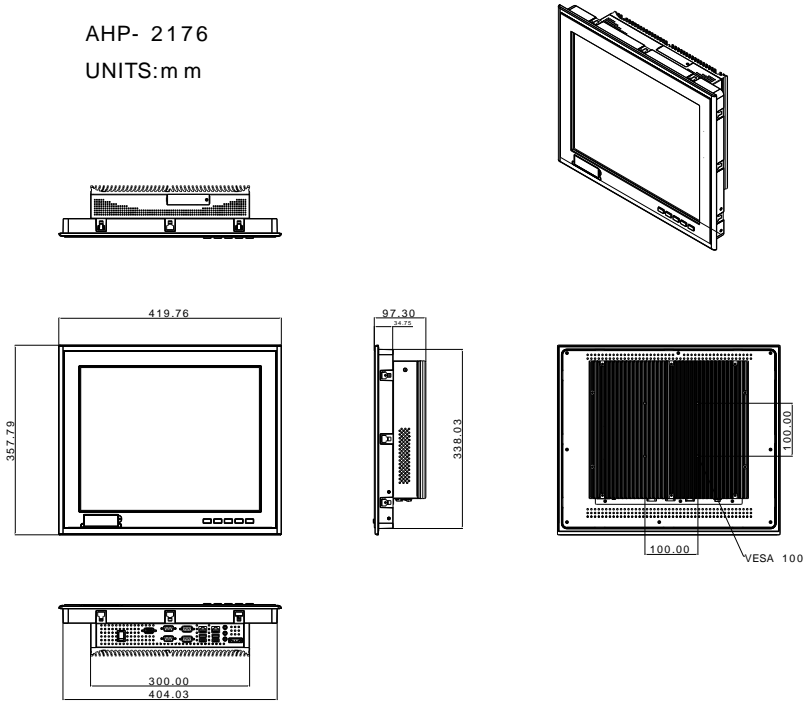

Chapter

2

**Hardware  
Installation**



## 2.1 Panelmount Installation

---

The display panel can be mounted into the wall. You will need the screws along with the mounting brackets, which be packed in the accessory box. Follow the steps below:

Before you start to follow the instructions, please place the display panel into the wall. See the following illustration on the left.

Step 1: Place the mounting brackets and plug the screw.

Step 2: Aim the mounting set at the hole on the monitor.

Step 3: Move the mounting set to the narrow gauge and fix it with screws.

Step 4: You've completed the preliminary when the mounting set is tightened. Next, repeat the steps and tighten all mounting set around the monitor until the monitor is firmly mounting on the wall.

1

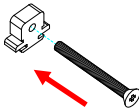

2

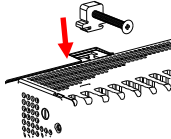

3

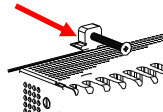

4

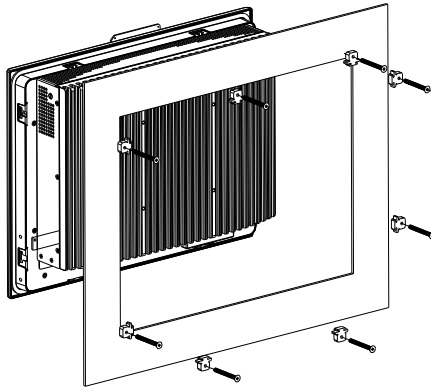
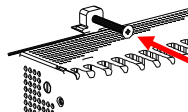

**Complete Illustration**

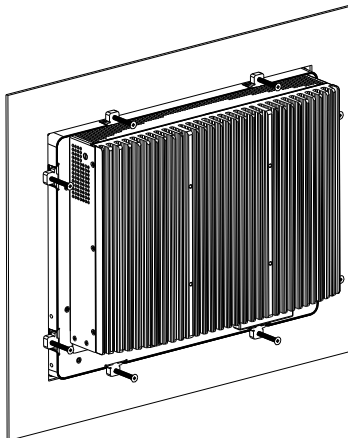

## 2.2 COM Port Connector

---

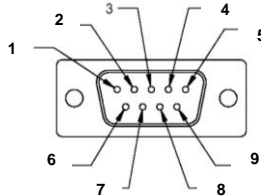

Pin	Signal	Pin	Signal
1	DCD	2	RXD
3	TXD	4	DTR
5	GND	6	DSR
7	RTS	8	CTS
9	RI		

## 2.3 Hard Disk Drive Installation

---

Step 1: Unfasten the screws of the heatsink

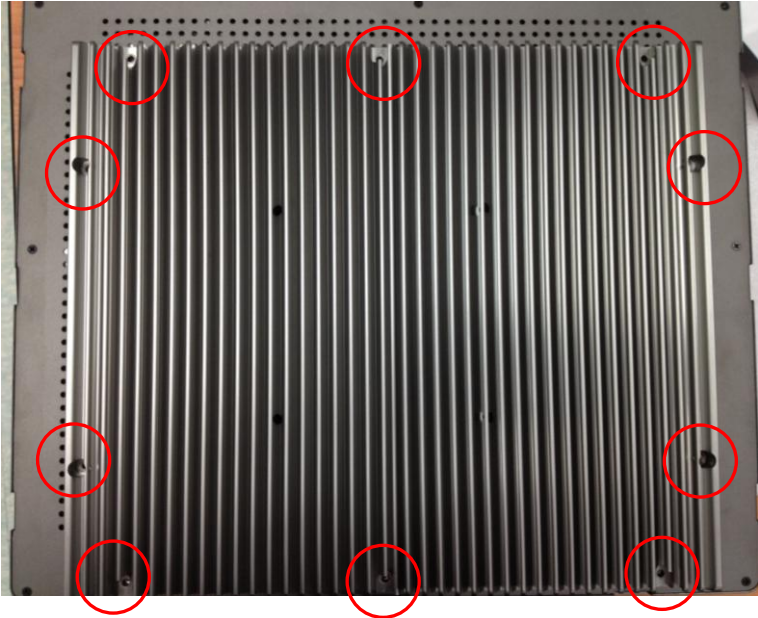

Step 2: Get the Bracket of Hard Disk Drive from the package



Step 3: Fasten the Hard Disk onto the bracket

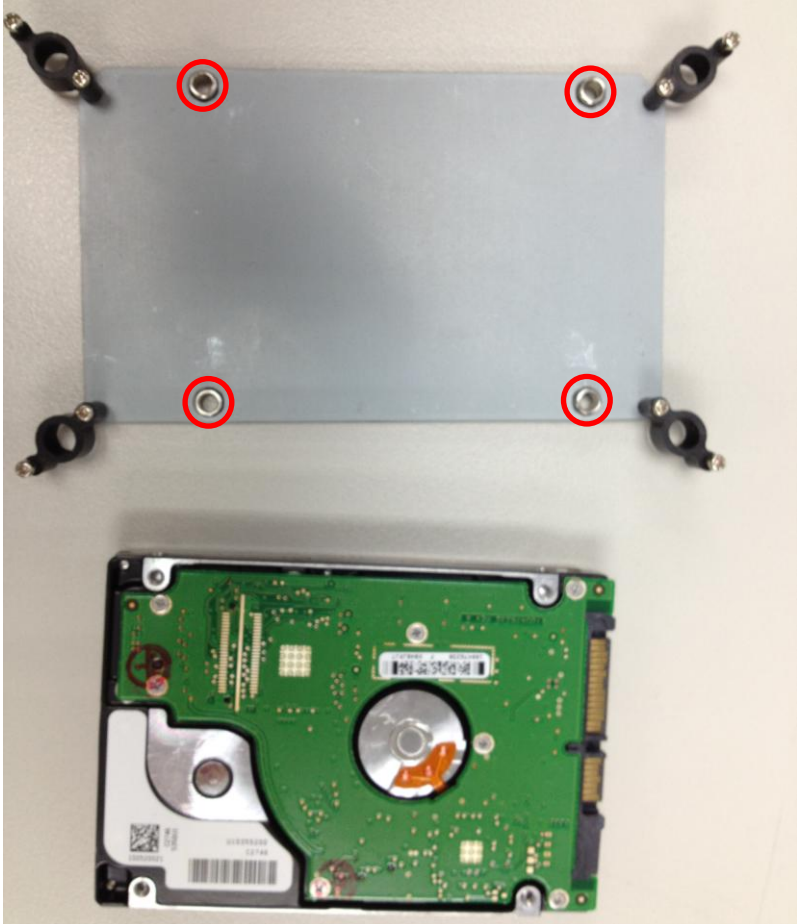

Step 4: Fasten the screws of the hard disk bracket onto the AHP-2176



The warning shall be either

- the symbol (IEC 60417-5041 (DB:2002-10)):
- or the following or similar wording



**WARNING  
HOT SURFACE  
DO NOT TOUCH**

Chapter

3

# AMI BIOS Setup

### 3.1 System Test and Initialization

---

These routines test and initialize board hardware. If the routines encounter an error during the tests, you will either hear a few short beeps or see an error message on the screen. There are two kinds of errors: fatal and non-fatal. The system can usually continue the boot up sequence with non-fatal errors.

#### System configuration verification

These routines check the current system configuration stored in the CMOS memory and BIOS NVRAM. If system configuration is not found or system configuration data error is detected, system will load optimized default and re-boot with this default system configuration automatically.

There are four situations in which you will need to setup system configuration:

1. You are starting your system for the first time
2. You have changed the hardware attached to your system
3. The system configuration is reset by Clear-CMOS jumper
4. The CMOS memory has lost power and the configuration information has been erased.

The AHP-2176 CMOS memory has an integral lithium battery backup for data retention. However, you will need to replace the complete unit when it finally runs down.



## 3.2 AMI BIOS Setup

---

AMI BIOS ROM has a built-in Setup program that allows users to modify the basic system configuration. This type of information is stored in battery-backed CMOS RAM and BIOS NVRAM so that it retains the Setup information when the power is turned off.

### Entering Setup

Power on the computer and press <Del> or <F2> immediately. This will allow you to enter Setup.

### Main

Set the date, use tab to switch between date elements.

### Advanced

Enable/disable boot option for legacy network devices.

### Chipset

Host bridge parameters.

### Boot

Enables/disables quiet boot option.

### Security

Set setup administrator password.

### Save&Exit

Exit system setup after saving the changes.

## Setup Menu

### Setup submenu: Main

Aptio Setup Utility - Copyright (C) 2010 American Megatrends, Inc.	
Main Advanced Chipset Boot Security Save & Exit	
BIOS Information AHP-2176 R1.1(2176AM11) (08/22/2012)	Set the Date. Use Tab to switch between Data elements.
BIOS Vendor Core Version Compliance	American Megatrends 4.6.4.0 UEFI 2.1
System Date System Time	[Tue 07/24/2012] [12:05:15]
Access Level	Administrator
	+/: Select Screen ↑: Select Item Enter: Select +/-: Change Opt. F1: General Help F2: Previous Values F3: Optimized Defaults F4: Save & Exit ESC: Exit
Version 2.10.1208. Copyright (C) 2010 American Megatrends, Inc.	

## Setup submenu: Advanced

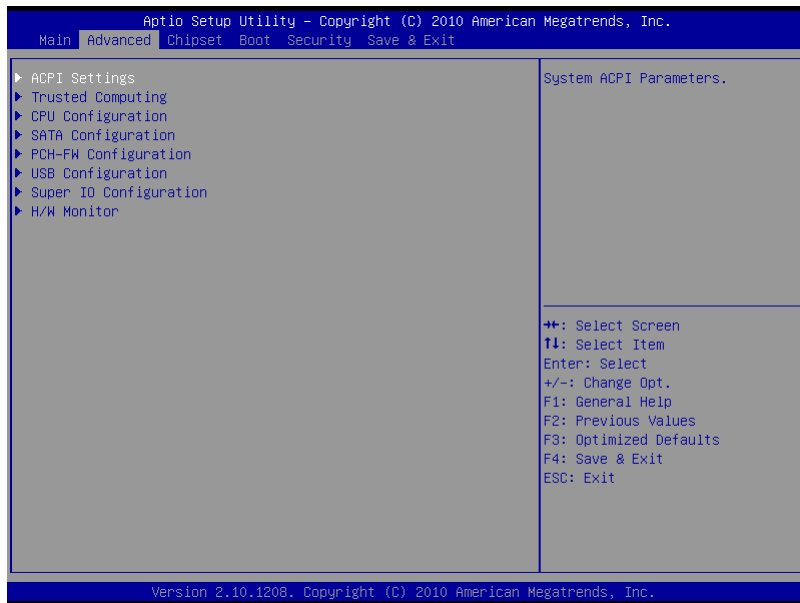

## ACPI Settings

Aptio Setup Utility - Copyright (C) 2010 American Megatrends, Inc.

Advanced

<p>ACPI Settings</p> <p>ACPI Sleep State [S3 (Suspend to RAM)]</p>	<p>Select the highest ACPI sleep state the system will enter when the SUSPEND button is pressed.</p> <hr/> <p>                     ++: Select Screen                      ↑: Select Item                      Enter: Select                      +/-: Change Opt.                      F1: General Help                      F2: Previous Values                      F3: Optimized Defaults                      F4: Save &amp; Exit                      ESC: Exit                 </p>
--	---

Version 2.10.1208. Copyright (C) 2010 American Megatrends, Inc.

### Options Summary :

ACPI Sleep State	Suspend Disabled	
	S1 (CPU Stop Clock)	
	S3 (Suspend to RAM)	Default
Select the Highest ACPI sleep state the system will enter when the SUSPEND button is pressed.		

## Trusted Computing

Aptio Setup Utility - Copyright (C) 2010 American Megatrends, Inc.

Advanced

<p>TPM Configuration                  TPM SUPPORT [Disable]</p> <p>Current TPM Status Information                  TPM SUPPORT OFF</p>	<p>Enables or Disables TPM support. O.S. will not show TPM. Reset of platform is required.</p> <hr/> <p>                     ++: Select Screen                      ↑↓: Select Item                      Enter: Select                      +/-: Change Opt.                      F1: General Help                      F2: Previous Values                      F3: Optimized Defaults                      F4: Save &amp; Exit                      ESC: Exit                 </p>
--	--

Version 2.10.1208. Copyright (C) 2010 American Megatrends, Inc.

### Option Summary :

TPM SUPPORT	Disable	Default
	Enable	
Enables or Disables TPM support. O.S. will not show TPM. Reset of platform is required.		

## CPU Configuration

Aptio Setup Utility - Copyright (C) 2010 American Megatrends, Inc.

Advanced

CPU Configuration		When enabled, a VMM can utilize the additional hardware capabilities provided by Vanderpool Technology
Intel(R) Celeron(R) CPU 827E @ 1.40GHz		
CPU Signature	206a7	
Microcode Patch	25	
Max CPU Speed	1400 MHz	
Min CPU Speed	800 MHz	
Processor Cores	1	
Intel HT Technology	Not Supported	
Intel VT-x Technology	Supported	
64-bit	Supported	
L1 Data Cache	32 kB x 1	
L1 Code Cache	32 kB x 1	
L2 Cache	256 kB x 1	
L3 Cache	1536 kB	
Intel Virtualization Technology	[Enabled]	++: Select Screen ↑↓: Select Item Enter: Select +/-: Change Opt. F1: General Help F2: Previous Values F3: Optimized Defaults F4: Save & Exit ESC: Exit

Version 2.10.1208. Copyright (C) 2010 American Megatrends, Inc.

### Options Summary :

Intel Virtualization Technology	Disabled	
	Enabled	Default
When enabled, a VMM can utilize the additional hardware capabilities provided by Vanderpool Technology		

## SATA Configuration (IDE)

Aptio Setup Utility - Copyright (C) 2010 American Megatrends, Inc.

Advanced

SATA Controller(s)	[Enabled]	Enable or disable SATA Device.
SATA Mode Selection	[IDE]	
Serial ATA Port 0	Empty	
Serial ATA Port 1	Empty	
Serial ATA Port 2	Empty	
Serial ATA Port 3	Empty	
Serial ATA Port 4	Empty	

++: Select Screen  
 ↑↓: Select Item  
 Enter: Select  
 +/-: Change Opt.  
 F1: General Help  
 F2: Previous Values  
 F3: Optimized Defaults  
 F4: Save & Exit  
 ESC: Exit

Version 2.10.1208. Copyright (C) 2010 American Megatrends, Inc.

### Options Summary :

SATA Controller(s)	Enabled	Default
	Disabled	
Enable or disable SATA Device.		
SATA Mode Selection	IDE	Default
	AHCI	
	RAID	
Determines how SATA controller(s) operate.		

## IDE Configuration (AHCI)

Aptio Setup Utility - Copyright (C) 2010 American Megatrends, Inc.

Advanced

SATA Controller(s)	[Enabled]	Determines how SATA controller(s) operate.
SATA Mode Selection	[AHCI]	
Serial ATA Port 0	Empty	⇧+: Select Screen ⇩↓: Select Item Enter: Select +/-: Change Opt. F1: General Help F2: Previous Values F3: Optimized Defaults F4: Save & Exit ESC: Exit
Hot Plug	[Disabled]	
Serial ATA Port 1	Empty	
Hot Plug	[Disabled]	
Serial ATA Port 2	Empty	
Hot Plug	[Disabled]	
Serial ATA Port 3	Empty	
Hot Plug	[Disabled]	
Serial ATA Port 4	Empty	
Hot Plug	[Disabled]	

Version 2.10.1208. Copyright (C) 2010 American Megatrends, Inc.

### Options Summary :

SATA Controller(s)	Disabled	
	Enabled	Default
Enable or Disable SATA Port.		
SATA Mode Selection	IDE	
	AHCI	Selected
	RAID	
Determines how SATA controller(s) operate.		
SATA Port 0 Hot Plug	Disable	Default
	Enabled	
Designates this port as Hot Pluggable.		
SATA Port 1 Hot Plug	Disable	Default
	Enabled	
Designates this port as Hot Pluggable.		
SATA Port 2 Hot Plug	Disable	Default
	Enabled	
Designates this port as Hot Pluggable.		



SATA Port 3 Hot Plug	Disable	Default
	Enabled	
Designates this port as Hot Pluggable.		
SATA Port 4 Hot Plug	Disable	Default
	Enabled	
Designates this port as Hot Pluggable.		

## IDE Configuration (RAID)

Aptio Setup Utility - Copyright (C) 2010 American Megatrends, Inc.

Advanced

SATA Controller(s)	[Enabled]	Determines how SATA controller(s) operate.
SATA Mode Selection	[RAID]	
Serial ATA Port 0	Empty	⇧⇩: Select Screen ⇧⇩: Select Item Enter: Select +/-: Change Opt. F1: General Help F2: Previous Values F3: Optimized Defaults F4: Save & Exit ESC: Exit
Hot Plug	[Disabled]	
Serial ATA Port 1	Empty	
Hot Plug	[Disabled]	
Serial ATA Port 2	Empty	
Hot Plug	[Disabled]	
Serial ATA Port 3	Empty	
Hot Plug	[Disabled]	
Serial ATA Port 4	Empty	
Hot Plug	[Disabled]	

Version 2.10.1208. Copyright (C) 2010 American Megatrends, Inc.

### Options Summary :

SATA Controller(s)	Disabled	
	Enabled	Default
Enable or Disable SATA Port.		
SATA Mode	IDE	
	AHCI	
	RAID	Selected
Determines how SATA controller(s) operate.		
SATA Port 0 Hot Plug	Disable	Default
	Enabled	
Designates this port as Hot Pluggable.		
SATA Port 1 Hot Plug	Disable	Default
	Enabled	
Designates this port as Hot Pluggable.		
SATA Port 2 Hot Plug	Disable	Default
	Enabled	
Designates this port as Hot Pluggable.		

SATA Port 3 Hot Plug	Disable	Default
	Enabled	
Designates this port as Hot Pluggable.		
SATA Port 4 Hot Plug	Disable	Default
	Enabled	
Designates this port as Hot Pluggable.		

## PCH-FW Configuration

Aptio Setup Utility - Copyright (C) 2010 American Megatrends, Inc.

Advanced

ME FW Version	7.1.40.1161	Configure Management Engine Technology Parameters
ME Firmware Mode	Normal Mode	
ME Firmware Type	Full Sku Firmware	
ME Firmware SKU	5MB	
▶ Firmware Update Configuration		
		⇧+: Select Screen ⇧↓: Select Item Enter: Select +/-: Change Opt. F1: General Help F2: Previous Values F3: Optimized Defaults F4: Save & Exit ESC: Exit

Version 2.10.1208. Copyright (C) 2010 American Megatrends, Inc.

### Options Summary :

Firmware Update Configuration	Configure Management Engine Technology Parameters.
-------------------------------	--

## Firmware Update Configuration

Aptio Setup Utility - Copyright (C) 2010 American Megatrends, Inc.

Advanced

Me FW Image Re-Flash	[Disabled]	Enable/Disable Me FW Image Re-Flash function.
		++: Select Screen ↑↓: Select Item Enter: Select +/-: Change Opt. F1: General Help F2: Previous Values F3: Optimized Defaults F4: Save & Exit ESC: Exit

Version 2.10.1208. Copyright (C) 2010 American Megatrends, Inc.

### Options Summary :

Me FW Image	Disabled	Default
Re-Flash	Enabled	
Enable/Disable Me FW Image Re-Flash function.		

## USB Configuration

Aptio Setup Utility - Copyright (C) 2010 American Megatrends, Inc.

Advanced

USB Configuration  USB Devices: 1 Drive, 1 Keyboard, 1 Mouse, 2 Hubs  Legacy USB Support                      [Enabled]  Mass Storage Devices: Skymedi USB3_Pen_Drive 1.01            [Auto]	Enables Legacy USB support. AUTO option disables legacy support if no USB devices are connected. DISABLE option will keep USB devices available only for EFI applications.  ⇧+: Select Screen ↑↓: Select Item Enter: Select +/-: Change Opt. F1: General Help F2: Previous Values F3: Optimized Defaults F4: Save & Exit ESC: Exit
--	---

Version 2.10.1208. Copyright (C) 2010 American Megatrends, Inc.

### Options Summary :

Legacy USB Support	Enabled	Default
	Disabled	
	Auto	
Enable Legacy USB support. AUTO option disables legacy support if no USB devices are connected. DISABLE option will keep USB devices available only for EFI applications.		

## Super IO Configuration

Aptio Setup Utility - Copyright (C) 2010 American Megatrends, Inc.

Advanced

Super IO Configuration		Set Parameters of Serial Port 3 (COMC)
Super IO Chip	F81866	
▶ Serial Port 3 Configuration		
▶ Serial Port 4 Configuration		
▶ Serial Port 5 Configuration		
▶ Serial Port 6 Configuration		
Power Saving Function	[Disabled]	

⇧+: Select Screen  
 ↓↑: Select Item  
 Enter: Select  
 +/-: Change Opt.  
 F1: General Help  
 F2: Previous Values  
 F3: Optimized Defaults  
 F4: Save & Exit  
 ESC: Exit

Version 2.10.1208. Copyright (C) 2010 American Megatrends, Inc.

### Options Summary :

Serial Port 3 Configuration	Set Parameters of Serial Port 3 (COMC)	
Serial Port 4 Configuration	Set Parameters of Serial Port 4 (COMD)	
Serial Port 5 Configuration	Set Parameters of Serial Port 5 (COME)	
Serial Port 6 Configuration	Set Parameters of Serial Port 6 (COMF)	
Power Saving Function	Disabled	Default
	Enabled	
Enable to reduce power consumption is system off state. When Enabled, only power button can power-up system.		

## Serial Port 3 Configuration

Aptio Setup Utility - Copyright (C) 2010 American Megatrends, Inc.

Advanced

Serial Port 3 Configuration		Enable or Disable Serial Port (COM)
Serial Port	[Enabled]	⇧+: Select Screen ↑↓: Select Item Enter: Select +/-: Change Opt. F1: General Help F2: Previous Values F3: Optimized Defaults F4: Save & Exit ESC: Exit
Device Settings	IO=3E8h; IRQ=5;	
Change Settings	[Auto]	

Version 2.10.1208. Copyright (C) 2010 American Megatrends, Inc.

### Options Summary :

Serial Port	Enabled	Default
	Disabled	
Enable or Disable Serial Port (COM)		
Change Settings	Auto	Default
	IO=3E8h; IRQ=5;	
	IO=2E8h; IRQ=5;	
	IO=2D0h; IRQ=5'	
	IO=2D8h; IRQ=5;	
Select an optimal setting for Super IO device.		



## Serial Port 4 Configuration

Aptio Setup Utility - Copyright (C) 2010 American Megatrends, Inc.

Advanced

Serial Port 4 Configuration		Enable or Disable Serial Port (COM)
Serial Port	[Enabled]	⇧+: Select Screen ↑↓: Select Item Enter: Select +/-: Change Opt. F1: General Help F2: Previous Values F3: Optimized Defaults F4: Save & Exit ESC: Exit
Device Settings	IO=2E8h; IRQ=5;	
Change Settings	[Auto]	

Version 2.10.1208. Copyright (C) 2010 American Megatrends, Inc.

### Options Summary :

Serial Port	Enabled	Default
	Disabled	
Enable or Disable Serial Port (COM)		
Change Settings	Auto	Default
	IO=2E8h; IRQ=5;	
	IO=3E8h; IRQ=5;	
	IO=2D0h; IRQ=5;	
	IO=2D8h; IRQ=5;	
Select an optimal setting for Super IO device.		

## Serial Port 5 Configuration

Aptio Setup Utility - Copyright (C) 2010 American Megatrends, Inc.

Advanced

Serial Port 5 Configuration		Enable or Disable Serial Port (COM)
Serial Port	[Enabled]	⇧+: Select Screen ↑↓: Select Item Enter: Select +/-: Change Opt. F1: General Help F2: Previous Values F3: Optimized Defaults F4: Save & Exit ESC: Exit
Device Settings	IO=2D0h; IRQ=5;	
Change Settings	[Auto]	

Version 2.10.1208. Copyright (C) 2010 American Megatrends, Inc.

### Options Summary :

Serial Port	Enabled	Default
	Disabled	
Enable or Disable Serial Port (COM)		
Change Settings	Auto	Default
	IO=2D0h; IRQ=5;	
	IO=3E8h; IRQ=5;	
	IO=2E8h; IRQ=5;	
	IO=2D8h; IRQ=5;	
Select an optimal setting for Super IO device.		

## Serial Port 6 Configuration

Aptio Setup Utility - Copyright (C) 2010 American Megatrends, Inc.

Advanced

Serial Port 6 Configuration		Enable or Disable Serial Port (COM)
Serial Port	[Enabled]	⇧+: Select Screen ↑↓: Select Item Enter: Select +/-: Change Opt. F1: General Help F2: Previous Values F3: Optimized Defaults F4: Save & Exit ESC: Exit
Device Settings	IO=2D8h; IRQ=5;	
Change Settings	[Auto]	

Version 2.10.1208. Copyright (C) 2010 American Megatrends, Inc.

### Options Summary :

Serial Port	Enabled	Default
	Disabled	
Enable or Disable Serial Port (COM)		
Change Settings	Auto	Default
	IO=2D8h; IRQ=5	
	IO=3E8h; IRQ=5;	
	IO=2E8h; IRQ=5;	
	IO=2D0h; IRQ=5;	
Select an optimal setting for Super IO device.		

## H/W Monitor

Aptio Setup Utility - Copyright (C) 2010 American Megatrends, Inc.

Advanced

Pc Health Status

PCH Outside Temperature	: +38 %
CPU Outside Temperature	: +38 %
CPU Inside Temperature	: +34 %
PCH Inside Temperature	: +51 %
VCC_CORE	: +0.976 V
V5A_DUAL	: +5.040 V
V5S	: +5.040 V
V12S	: +11.704 V
VSBSV	: +5.256 V
VCC3V	: +3.376 V
VSBSV	: +3.408 V
VBAT	: +3.344 V

→+: Select Screen  
↑↓: Select Item  
Enter: Select  
+/-: Change Opt.  
F1: General Help  
F2: Previous Values  
F3: Optimized Defaults  
F4: Save & Exit  
ESC: Exit

Version 2.10.1208. Copyright (C) 2010 American Megatrends, Inc.

## Setup submenu: Chipset

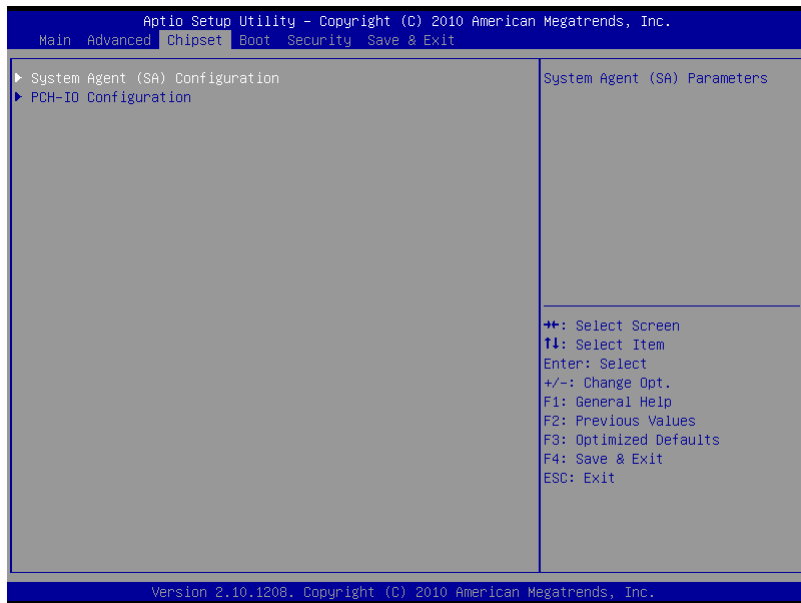

## System Agent (SA) Configuration

Aptio Setup Utility - Copyright (C) 2010 American Megatrends, Inc.

Chipset

VT-d Capability	Unsupported	Config Graphics Settings.
Memory Frequency	1067 Mhz	
Total Memory	4096 MB (DDR3)	
DIMM#0	4096 MB (DDR3)	
DIMM#2	Not Present	
▶ Graphics Configuration		
		++: Select Screen ↑: Select Item Enter: Select +/-: Change Opt. F1: General Help F2: Previous Values F3: Optimized Defaults F4: Save & Exit ESC: Exit

Version 2.10.1208. Copyright (C) 2010 American Megatrends, Inc.

### Options Summary :

Graphics Configuration	Config Graphics Settings.
------------------------	---------------------------

## Graphics Configuration

Aptio Setup Utility - Copyright (C) 2010 American Megatrends, Inc.

Chipset

<p>Graphics Configuration</p> <p>Internal Graphics [Auto]                  DVMT Pre-Allocated [64M]                  DVMT Total Gfx Mem [MAX]</p> <p>▶ Display Control</p>	<p>Keep IGD enabled based on the setup options.</p> <hr/> <p>                     ++: Select Screen                      ↑: Select Item                      Enter: Select                      +/-: Change Opt.                      F1: General Help                      F2: Previous Values                      F3: Optimized Defaults                      F4: Save &amp; Exit                      ESC: Exit                 </p>
--	--

Version 2.10.1208. Copyright (C) 2010 American Megatrends, Inc.

### Options Summary :

Internal Graphics	Auto	Default
	Disabled	
	Enabled	
Keep IGD enabled based on the setup options.		
DVMT Pre-Allocated	0M	
	32M	
	64M	Default
	96M	
	128M	
	160M	
	192M	
	224M	
	256M	
	288M	
	320M	
	352M	

	384M	
	416M	
	448M	
	480M	
	512M	
Select DVMT 5.0 Pre-Allocated (Fixed) Graphics Memory size used by the Internal Graphics Device.		
DVMT Total Gfx Mem	128M	
	256M	
	MAX	Default
Select DVMT5.0 Total Graphic Memory size used by the Internal Graphics Device.		



## Display Control

Aptio Setup Utility - Copyright (C) 2010 American Megatrends, Inc.

Chipset

<p>Display Control</p> <p>Boot Display Select [VBIOS Default]</p> <p>LCD Panel Type [1280x1024]</p> <p>Panel Color Depth [24 Bit]</p>	<p>Select the Video Device during POST and DOS. This has no effect if external graphics present.</p> <hr/> <p>                     ++: Select Screen                      ↑↓: Select Item                      Enter: Select                      +/-: Change Opt.                      F1: General Help                      F2: Previous Values                      F3: Optimized Defaults                      F4: Save &amp; Exit                      ESC: Exit                 </p>
---	--

Version 2.10.1208. Copyright (C) 2010 American Megatrends, Inc.

### Options Summary :

Boot Display Select	VBIOS Default	Default
	CRT	
	LVDS	
	CRT+LVDS	
Select the Video Device during POST and DOS. This has no effect if external graphics present.		
LCD Panel Type	640x480	
	800x480	
	800x600	
	1024x768	
	1280x1024	Default
	1600x1200	
	1366x768	
	1680x1050	
	1920x1200	
1440x900		

	1680x1050	
	1280x800	
	1920x1080	
Select LCD panel used by Internal Graphics Device by selecting the appropriate setup items.		
Panel Color Depth	18 bit	
	24 bit	
Select the LFP Panel Color Depth		

## PCH-IO Configuration

Aptio Setup Utility - Copyright (C) 2010 American Megatrends, Inc.

Chipset

<p>PCH-IO Configuration</p> <p>Power Mode [ATX Type] Restore AC Power Loss [Last State]</p> <p>Azalia [Auto] Azalia Internal HDMI Codec [Enabled] Azalia HDMI codec Port B [Disabled] Azalia HDMI codec Port C [Enabled] Azalia HDMI codec Port D [Disabled]</p> <p>PCH LAN Controller [Enabled] Wake on LAN [Enabled]</p> <p>OnBoard LAN 2 [Enabled] PCIe Mini-Card 1 [Enabled] PCIe Mini-Card 2 [Enabled]</p>	<p>Select power supply mode.</p> <hr/> <p>+/: Select Screen                  ↑: Select Item                  Enter: Select                  +/-: Change Opt.                  F1: General Help                  F2: Previous Values                  F3: Optimized Defaults                  F4: Save &amp; Exit                  ESC: Exit</p>
---	---

Version 2.10.1208. Copyright (C) 2010 American Megatrends, Inc.

### Options Summary :

Power Mode	ATX Type	Default
	AT Type	
Select power supply mode.		
Restore AC Power Loss	Power off	
	Power on	
	Last State	Default
Select AC power state when power is re-applied after a power failure.		
Azalia	Disabled	
	Enabled	
	Auto	Default
Control Detection of the Azalia device. Disabled = Azalia will be unconditionally disabled Enabled = Azalia will be unconditionally Enabled Auto = Azalia will be enabled if present, disabled otherwise.		
Azalia Internal HDMI Codec	Disabled	
	Enabled	Default

Enable or disable internal HDMI codec for Azalia.		
Azalia HDMI codec Port B	Disabled	Default
	Enabled	
Enable or disable internal HDMI codec Port for Azalia.		
Azalia HDMI codec Port C	Disabled	
	Enabled	Default
Enable or disable internal HDMI codec Port for Azalia.		
Azalia HDMI codec Port D	Disabled	Default
	Enabled	
Enable or disable internal HDMI codec Port for Azalia.		
PCH LAN Controller	Enabled	Default
	Disabled	
Enable or disable onboard NIC.		
Wake on LAN	Enabled	Default
	Disabled	
Enable or disable integrated LAN to wake the system.		
OnBoard LAN 2	Disabled	
	Enabled	Default
OnBoard LAN 2 RTL8111E LAN En/Disable Control		
PCIe Mini-Card 1	Disabled	
	Enabled	Default
Enable / Disable PCIe Mini-Card 1		
PCIe Mini-Card 2	Disabled	
	Enabled	Default
Enable / Disable PCIe Mini-Card 2		

**Setup submenu: Boot**

Aptio Setup Utility - Copyright (C) 2010 American Megatrends, Inc.					
Main	Advanced	Chipset	Boot	Security	Save & Exit
Boot Configuration Quiet Boot [Enabled] Launch I82579LM PXE OpROM [Disabled] Launch RTL8111E PXE OpROM [Disabled]				Enables or disables Quiet Boot option	
Boot Option Priorities Boot Option #1 [Skymedi USB3_Pen_D...] Boot Option #2 [UEFI: Skymedi USB3...]					
Hard Drive BBS Priorities					
				+-: Select Screen ↑↓: Select Item Enter: Select +/-: Change Opt. F1: General Help F2: Previous Values F3: Optimized Defaults F4: Save & Exit ESC: Exit	
Version 2.10.1208. Copyright (C) 2010 American Megatrends, Inc.					

**Options Summary :**

Quiet Boot	Disabled	
	Enabled	Default
Enables or disables Quiet Boot option		
Launch I82579LM PXE OpROM	Disabled	Default
	Enabled	
Enable or Disable Legacy Boot Option for I82579LM.		
Launch RTL8111E PXE OpROM	Disabled	Default
	Enabled	
Enable or Disable Legacy Boot Option for RTL8111E		
Boot options #X	Your storage/disk devices	
Sets the system boot order		

## Hard Drives BBS Priorities

Aptio Setup Utility - Copyright (C) 2010 American Megatrends, Inc.		
Boot		
Boot Option #1	[Skymedi USB3_Pen_D...]	Sets the system boot order
		<b>+</b> +: Select Screen <b>↑↓</b> : Select Item Enter: Select +/-: Change Opt. F1: General Help F2: Previous Values F3: Optimized Defaults F4: Save & Exit ESC: Exit
Version 2.10.1208. Copyright (C) 2010 American Megatrends, Inc.		

## Submenu: Security

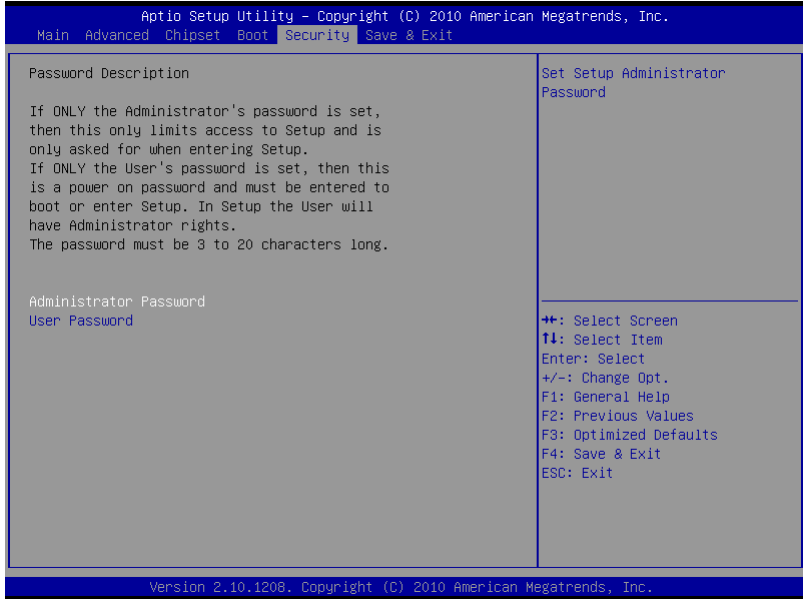

### Change User/Supervisor Password

You can install a Supervisor password, and if you install a supervisor password, you can then install a user password. A user password does not provide access to many of the features in the Setup utility.

If you highlight these items and press Enter, a dialog box appears which lets you enter a password. You can enter no more than six letters or numbers. Press Enter after you have typed in the password. A second dialog box asks you to retype the password for confirmation. Press Enter after you have retyped it correctly. The password is required at boot time, or when the user enters the Setup utility.

### Removing the Password

Highlight this item and type in the current password. At the next dialog box press Enter to disable password protection.

## Setup submenu: Exit

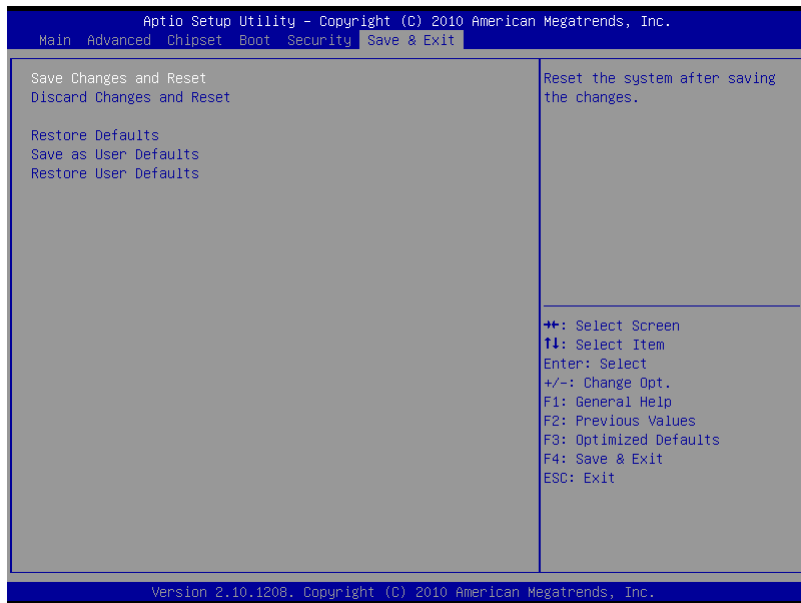



Chapter

4

**Driver  
Installation**

The AHP-2176 comes with an AutoRun DVD-ROM that contains all drivers and utilities that can help you to install the driver automatically.

Insert the driver DVD, the driver DVD-title will auto start and show the installation guide. If not, please follow the sequence below to install the drivers.

***Follow the sequence below to install the drivers:***

Step 1 – Install Chipset Driver

Step 2 – Install VGA Driver

Step 3 – Install Audio Driver

Step 4 – Install LAN Driver

Step 5 – Install ME Driver

Step 6 – Install TPM Driver

Step 7 – Install Touch Panel Driver

Step 8 – Install Serial Port Driver (Optional)

**Note:** If you got compatible issue for COM port, please find its driver under STEP 8 folder and then install it by administrative login permission.

Please read instructions below for further detailed installations.

## 4.1 Installation:

---

Insert the AHP-2176 DVD-ROM into the DVD-ROM drive. And install the drivers from Step 1 to Step 8 in order.

### Step 1 – Install Chipset Driver

1. Click on the **STEP 1-CHIPSET** folder and double click on the **infinst\_autol.exe** file
2. Follow the instructions that the window shows
3. The system will help you install the driver automatically

### Step 2 – Install VGA Driver

1. Click on the **STEP2-VGA** folder and select the OS folder your system is
2. Double click on the **.exe** file located in each OS folder
3. Follow the instructions that the window shows
4. The system will help you install the driver automatically

#### **Note 1:**

- This motherboard supports VGA and LVDS display devices. In Single Display mode, use the hot keys to switch between VGA to LVDS device or vice versa. By default, press **<Ctrl>+<Alt>+<F1>** to switch to VGA device and press **<Ctrl>+<Alt>+<F3>** to switch to LVDS device.
- Before removing the current display device, connect the display device that you want to use, and then press the hot keys to switch to that device.

**Note 2:** If the OS is Windows® XP, you have to install the driver of dotNet Framework first. Simply click on **dotnetfx35.exe** located in

**dotNet Framework** folder.

### Step 3 –Install Audio Driver

1. Click on the **STEP3-AUDIO** folder and select the OS folder your system is
2. Double click on the **.exe** located in each OS folder
3. Follow the instructions that the window shows
4. The system will help you install the driver automatically

### Step 4 –Install LAN Driver

1. Click on the **STEP4-LAN** folder and select the folder of **intel\_82579** or **realtek\_8111E** based on the LAN chipset in your system.
2. Select the OS folder your system is located in the chipset folder, then double click on **.exe** file located in each OS folder
3. Follow the instructions that the window shows
4. The system will help you install the driver automatically

### Step 5 – Install ME Driver

1. Click on the **STEP5-ME** folder and double click on the **setup.exe** file
2. Follow the instructions that the window shows
3. The system will help you install the driver automatically

### Step 6 – Install TPM Driver

1. Click on the **STEP6-TPM** folder and double click on the **Setup.exe** file
2. Follow the instructions that the window shows
3. The system will help you install the driver automatically

### Step 7 – Install Touch Panel Driver

1. Click on the **STEP7-Touch Panel Driver** folder and select the OS folder your system is
2. Double click on the **setup.exe** file located in each OS folder
3. Follow the instructions that the window shows
4. The system will help you install the driver automatically

### Step 8 –Install Serial Port Driver (Optional)

For Windows® XP 32-bit, select the folder of **WINXP\_32** and double click on the **patch.bat**

For Windows® 7, please refer to the installation procedures below.

1. Create a password for Administrator account.

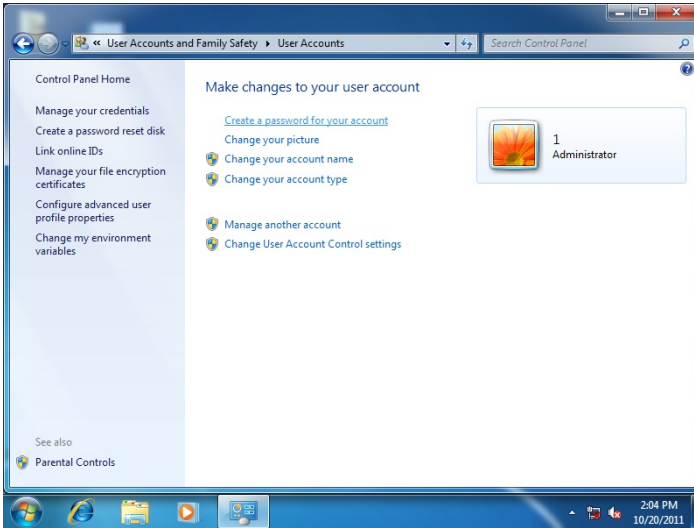

2. Change User Account Control Settings to [Never notify]

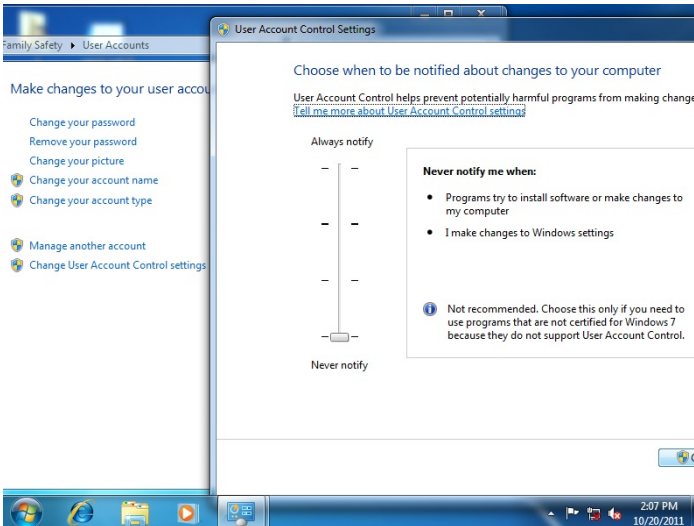

3. Reboot and Administrator login.

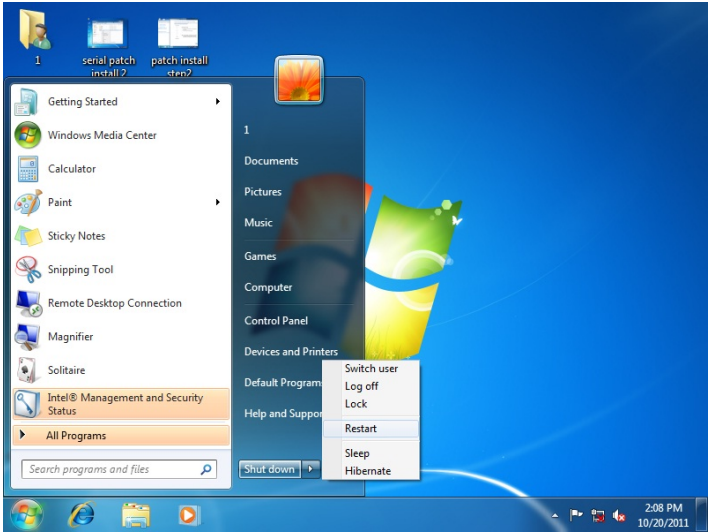

4. To run patch.bat with [Run as administrator].

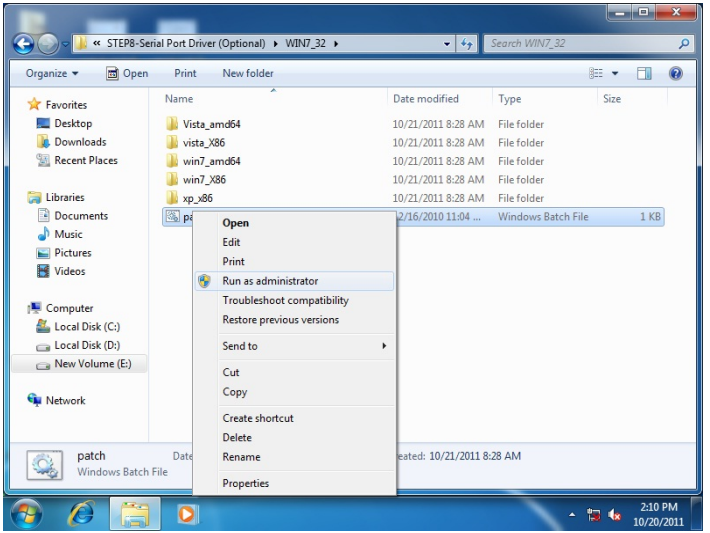

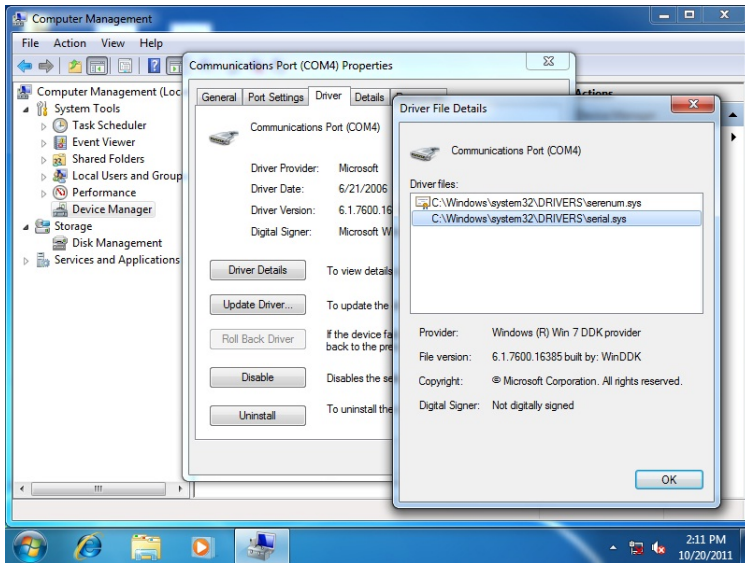



Appendix

**A**

# **Programming the Watchdog Timer**

## A.1 Watchdog Timer Initial Program

Table 1 : SuperIO relative register table		
	Default Value	Note
Index	0x2E(Note1)	SIO MB PnP Mode Index Register 0x2E or 0x4E
Data	0x2F(Note2)	SIO MB PnP Mode Data Register 0x2F or 0x4F

Table 2 : Watchdog relative register table					
	LDN	Register	BitNum	Value	Note
Timer Counter	0x07 (Note3)	0xF6 (Note4)		(Note24)	Time of watchdog timer (0~255) This register is byte access
Counting Unit	0x07 (Note5)	0xF5 (Note6)	3 (Note7)	0(Note8)	Select time unit. 0: second 1: minute
Watchdog Enable	0x07 (Note9)	0xF5 (Note10)	5 (Note11)	1 (Note12)	0: Disable 1: Enable
Timeout Status	0x07 (Note13)	0xF5 (Note14)	6 (Note15)	1	1:Clear timeout status
Output Mode	0x07 (Note16)	0xF5 (Note17)	4 (Note18)	1 (Note19)	Select WDTRST# output mode 0: level 1: pulse
WDTRST output	0x07 (Note20)	0xFA (Note21)	0 (Note22)	1(Note23)	Enable/Disable time out output via WDTRST# 0: Disable 1: Enable

\*\*\*\*\*

\*\*\*

// SuperIO relative definition (Please reference to Table 1)

**#define byte** SIOIndex //This parameter is represented from **Note1**

**#define byte** SIOData //This parameter is represented from **Note2**

**#define void** IOWriteByte(**byte** IOPort, **byte** Value);

**#define byte** IOReadByte(**byte** IOPort);

// Watch Dog relative definition (Please reference to Table 2)

**#define byte** TimerLDN //This parameter is represented from **Note3**

**#define byte** TimerReg //This parameter is represented from **Note4**

**#define byte** TimerVal // This parameter is represented from **Note24**

**#define byte** UnitLDN //This parameter is represented from **Note5**

**#define byte** UnitReg //This parameter is represented from **Note6**

**#define byte** UnitBit //This parameter is represented from **Note7**

**#define byte** UnitVal //This parameter is represented from **Note8**

**#define byte** EnableLDN //This parameter is represented from **Note9**

**#define byte** EnableReg //This parameter is represented from **Note10**

**#define byte** EnableBit //This parameter is represented from **Note11**

**#define byte** EnableVal //This parameter is represented from **Note12**

**#define byte** StatusLDN // This parameter is represented from **Note13**

**#define byte** StatusReg // This parameter is represented from **Note14**

**#define byte** StatusBit // This parameter is represented from **Note15**

**#define byte** ModeLDN // This parameter is represented from **Note16**

**#define byte** ModeReg // This parameter is represented from **Note17**

**#define byte** ModeBit // This parameter is represented from **Note18**

**#define byte** ModeVal // This parameter is represented from **Note19**

**#define byte** WDTRstLDN // This parameter is represented from **Note20**

**#define byte** WDTRstReg // This parameter is represented from **Note21**

**#define byte** WDRstBit // This parameter is represented from **Note22**

**#define byte** WDRstVal // This parameter is represented from **Note23**

\*\*\*\*\*

\*\*\*

\*\*\*\*\*

\*\*\*

VOID **Main**() {

// Procedure : AaeonWDTConfig

// (byte)Timer : Time of WDT timer.(0x00~0xFF)

// (boolean)Unit : Select time unit(0: second, 1: minute).

AaeonWDTConfig();

// Procedure : AaeonWDTEnable

// This procedure will enable the WDT counting.

AaeonWDTEnable();

}

\*\*\*\*\*

\*\*\*

\*\*\*\*\*

\*\*\*

// Procedure : AaeonWDTEnable

VOID **AaeonWDTEnable** () {

WDTEnableDisable(**EnableLDN**, **EnableReg**, **EnableBit**, 1);

}

// Procedure : AaeonWDTConfig

VOID **AaeonWDTConfig** () {

// Disable WDT counting

WDTEnableDisable(**EnableLDN**, **EnableReg**, **EnableBit**, 0);

// Clear Watchdog Timeout Status

WDTClearTimeoutStatus();

// WDT relative parameter setting

WDTParameterSetting();

}

```

VOID WDTEnableDisable(byte LDN, byte Register, byte BitNum,
byte Value){
    SIOBitSet(LDN, Register, BitNum, Value);
}

```

```

VOID WDTParameterSetting(){
    // Watchdog Timer counter setting
    SIOByteSet(TimerLDN, TimerReg, TimerVal);
    // WDT counting unit setting
    SIOBitSet(UnitLDN, UnitReg, UnitBit, UnitVal);
    // WDT output mode setting, level / pulse
    SIOBitSet(ModeLDN, ModeReg, ModeBit, ModeVal);
    // Watchdog timeout output via WDTRST#
    SIOBitSet(WDTRstLDN, WDTRstReg, WDTRstBit,
WDTRstVal);
}

```

```

VOID WDTClearTimeoutStatus(){
    SIOBitSet(StatusLDN, StatusReg, StatusBit, 1);
}

```

```

*****
***
*****
***

```

```

VOID SIOEnterMBPnPMode(){
    IOWriteByte(SIOIndex, 0x87);
    IOWriteByte(SIOIndex, 0x87);
}

```

```

VOID SIOExitMBPnPMode(){
    IOWriteByte(SIOIndex, 0xAA);
}

```

```

VOID SIOSelectLDN(byte LDN){
    IOWriteByte(SIOIndex, 0x07); // SIO LDN Register Offset = 0x07
    IOWriteByte(SIOData, LDN);
}

```

```
VOID SIOBitSet(byte LDN, byte Register, byte BitNum, byte
Value){
```

```
    Byte TmpValue;
```

```
    SIOEnterMBPnPMode();
```

```
    SIOSelectLDN(byte LDN);
```

```
    IOWriteByte(SIOIndex, Register);
```

```
    TmpValue = IOReadByte(SIOData);
```

```
    TmpValue &= ~(1 << BitNum);
```

```
    TmpValue |= (Value << BitNum);
```

```
    IOWriteByte(SIOData, TmpValue);
```

```
    SIOExitMBPnPMode();
```

```
}
```

```
VOID SIOByteSet(byte LDN, byte Register, byte Value){
```

```
    SIOEnterMBPnPMode();
```

```
    SIOSelectLDN(LDN);
```

```
    IOWriteByte(SIOIndex, Register);
```

```
    IOWriteByte(SIOData, Value);
```

```
    SIOExitMBPnPMode();
```

```
}
```

```
*****
```

```
***
```

Appendix

**B**

## **I/O Information**

## B.1 I/O Address Map

---

Input/output (I/O)	
[00000000 - 0000001F]	Direct memory access controller
[00000000 - 00000CF7]	PCI bus
[00000010 - 0000001F]	Motherboard resources
[00000020 - 00000021]	Programmable interrupt controller
[00000022 - 0000003F]	Motherboard resources
[00000024 - 00000025]	Programmable interrupt controller
[00000028 - 00000029]	Programmable interrupt controller
[0000002C - 0000002D]	Programmable interrupt controller
[0000002E - 0000002F]	Motherboard resources
[00000030 - 00000031]	Programmable interrupt controller
[00000034 - 00000035]	Programmable interrupt controller
[00000038 - 00000039]	Programmable interrupt controller
[0000003C - 0000003D]	Programmable interrupt controller
[00000040 - 00000043]	System timer
[00000044 - 0000005F]	Motherboard resources
[0000004E - 0000004F]	Motherboard resources
[00000050 - 00000053]	System timer
[00000060 - 00000060]	Standard PS/2 Keyboard
[00000061 - 00000061]	Motherboard resources
[00000063 - 00000063]	Motherboard resources
[00000064 - 00000064]	Standard PS/2 Keyboard
[00000065 - 00000065]	Motherboard resources
[00000067 - 00000067]	Motherboard resources
[00000070 - 00000070]	Motherboard resources
[00000070 - 00000077]	System CMOS/real time clock
[00000072 - 0000007F]	Motherboard resources
[00000080 - 00000080]	Motherboard resources
[00000080 - 00000080]	Motherboard resources
[00000081 - 00000091]	Direct memory access controller
[00000084 - 00000086]	Motherboard resources
[00000088 - 00000088]	Motherboard resources
[0000008C - 0000008E]	Motherboard resources
[00000090 - 0000009F]	Motherboard resources
[00000092 - 00000092]	Motherboard resources
[00000093 - 0000009F]	Direct memory access controller
[000000A0 - 000000A1]	Programmable interrupt controller
[000000A2 - 000000BF]	Motherboard resources
[000000A4 - 000000A5]	Programmable interrupt controller
[000000A8 - 000000A9]	Programmable interrupt controller
[000000AC - 000000AD]	Programmable interrupt controller
[000000B0 - 000000B1]	Programmable interrupt controller
[000000B2 - 000000B3]	Motherboard resources
[000000B4 - 000000B5]	Programmable interrupt controller
[000000B8 - 000000B9]	Programmable interrupt controller
[000000BC - 000000BD]	Programmable interrupt controller
[000000C0 - 000000DF]	Direct memory access controller

























































[00000E0 - 00000EF]	Motherboard resources
[00000F0 - 00000FF]	Numeric data processor
[00002D0 - 00002D7]	Communications Port (COM5)
[00002D8 - 00002DF]	Communications Port (COM6)
[00002E8 - 00002EF]	Communications Port (COM4)
[00003B0 - 00003BF]	Intel(R) HD Graphics Family
[00003C0 - 00003CF]	Intel(R) HD Graphics Family
[00003E8 - 00003EF]	Communications Port (COM3)
[0000400 - 0000453]	Motherboard resources
[0000454 - 0000457]	Motherboard resources
[0000458 - 000047F]	Motherboard resources
[00004D0 - 00004D1]	Motherboard resources
[00004D0 - 00004D1]	Programmable interrupt controller
[0000500 - 000057F]	Motherboard resources
[0000680 - 000069F]	Motherboard resources
[0000A00 - 0000A0F]	Motherboard resources
[0000A10 - 0000A1F]	Motherboard resources
[0000A20 - 0000A2F]	Motherboard resources
[0000D00 - 0000FFF]	PCI bus
[0001000 - 000100F]	Motherboard resources
[000164E - 000164F]	Motherboard resources
[0000E00 - 0000E0F]	Realtek PCIe GBE Family Controller #3
[0000E00 - 0000E0F]	Intel(R) 6 Series/C200 Series Chipset Family PCI Express Root Port 2 - 1C12
[0000F00 - 0000F03F]	Intel(R) HD Graphics Family
[0000F040 - 0000F05F]	Intel(R) 6 Series/C200 Series Chipset Family SMBus Controller - 1C22
[0000F060 - 0000F07F]	Intel(R) 6 Series/C200 Series Chipset Family 6 Port SATA AHCI Controller - 1C03
[0000F0A0 - 0000F0A3]	Intel(R) 6 Series/C200 Series Chipset Family 6 Port SATA AHCI Controller - 1C03
[0000F0B0 - 0000F0BF]	Intel(R) 6 Series/C200 Series Chipset Family 6 Port SATA AHCI Controller - 1C03
[0000FC0 - 0000FC3]	Intel(R) 6 Series/C200 Series Chipset Family 6 Port SATA AHCI Controller - 1C03
[0000FD0 - 0000FD7]	Intel(R) 6 Series/C200 Series Chipset Family 6 Port SATA AHCI Controller - 1C03
[0000FFF - 0000FFF]	Motherboard resources
[0000FFF - 0000FFF]	Motherboard resources

## B.2 Memory Address Map

Address Range	Device Name
[000A0000 - 000BFFFF]	Intel(R) HD Graphics Family
[000A0000 - 000BFFFF]	PCI bus
[000D0000 - 000D3FFF]	PCI bus
[000D4000 - 000D7FFF]	PCI bus
[000D8000 - 000DBFFF]	PCI bus
[000DC000 - 000DFFFF]	PCI bus
[000E0000 - 000E3FFF]	PCI bus
[000E4000 - 000E7FFF]	PCI bus
[20000000 - 201FFFFFF]	System board
[40000000 - 401FFFFFF]	System board
[DFA00000 - DFA00FFF]	Motherboard resources
[DFA00000 - FEAFFFFF]	PCI bus
[E0000000 - EFFFFFFF]	Intel(R) HD Graphics Family
[F0000000 - F003FFF]	Realtek PCIe GBE Family Controller #3
[F0000000 - F00FFFFF]	Intel(R) 6 Series/C200 Series Chipset Family PCI Express Root Port 2 - 1C12
[F7800000 - F7BFFFFF]	Intel(R) HD Graphics Family
[F7C00000 - F7C00FFF]	Realtek PCIe GBE Family Controller #3
[F7C00000 - F7CFFFFF]	Intel(R) 6 Series/C200 Series Chipset Family PCI Express Root Port 2 - 1C12
[F7D00000 - F7D1FFFF]	Intel(R) 82579LM Gigabit Network Connection
[F7D20000 - F7D23FFF]	High Definition Audio Controller
[F7D25000 - F7D250FF]	Intel(R) 6 Series/C200 Series Chipset Family SMBus Controller - 1C22
[F7D26000 - F7D267FF]	Intel(R) 6 Series/C200 Series Chipset Family 6 Port SATA AHCI Controller - 1C03
[F7D27000 - F7D273FF]	Intel(R) 6 Series/C200 Series Chipset Family USB Enhanced Host Controller - 1C26
[F7D28000 - F7D283FF]	Intel(R) 6 Series/C200 Series Chipset Family USB Enhanced Host Controller - 1C2D
[F7D29000 - F7D29FFF]	Intel(R) 82579LM Gigabit Network Connection
[F7D2B000 - F7D2B00F]	Intel(R) Management Engine Interface
[F8000000 - FBFFFFFF]	Motherboard resources
[FED00000 - FED003FF]	High precision event timer
[FED10000 - FED17FFF]	Motherboard resources
[FED18000 - FED18FFF]	Motherboard resources
[FED19000 - FED19FFF]	Motherboard resources
[FED1C000 - FED1FFFF]	Motherboard resources
[FED20000 - FED3FFFF]	Motherboard resources
[FED40000 - FED44FFF]	System board
[FED45000 - FED8FFFF]	Motherboard resources
[FED90000 - FED93FFF]	Motherboard resources
[FEE00000 - FEEFFFFF]	Motherboard resources
[FF000000 - FFFFFFFF]	Intel(R) 82802 Firmware Hub Device
[FF000000 - FFFFFFFF]	Motherboard resources



## B.3 IRQ Mapping Chart

Interrupt request (IRQ)	Device
(ISA) 0x00000000 (00)	System timer
(ISA) 0x00000001 (01)	Standard PS/2 Keyboard
(ISA) 0x00000005 (05)	Communications Port (COM3)
(ISA) 0x00000005 (05)	Communications Port (COM4)
(ISA) 0x00000005 (05)	Communications Port (COM5)
(ISA) 0x00000005 (05)	Communications Port (COM6)
(ISA) 0x00000008 (08)	System CMOS/real time clock
(ISA) 0x0000000C (12)	Microsoft PS/2 Mouse
(ISA) 0x0000000D (13)	Numeric data processor
(ISA) 0x00000051 (81)	Microsoft ACPI-Compliant System
(ISA) 0x00000052 (82)	Microsoft ACPI-Compliant System
(ISA) 0x00000053 (83)	Microsoft ACPI-Compliant System
(ISA) 0x00000054 (84)	Microsoft ACPI-Compliant System
(ISA) 0x00000055 (85)	Microsoft ACPI-Compliant System
(ISA) 0x00000056 (86)	Microsoft ACPI-Compliant System
(ISA) 0x00000057 (87)	Microsoft ACPI-Compliant System
(ISA) 0x00000058 (88)	Microsoft ACPI-Compliant System
(ISA) 0x00000059 (89)	Microsoft ACPI-Compliant System
(ISA) 0x0000005A (90)	Microsoft ACPI-Compliant System
(ISA) 0x0000005B (91)	Microsoft ACPI-Compliant System
(ISA) 0x0000005C (92)	Microsoft ACPI-Compliant System
(ISA) 0x0000005D (93)	Microsoft ACPI-Compliant System
(ISA) 0x0000005E (94)	Microsoft ACPI-Compliant System
(ISA) 0x0000005F (95)	Microsoft ACPI-Compliant System
(ISA) 0x00000060 (96)	Microsoft ACPI-Compliant System
(ISA) 0x00000061 (97)	Microsoft ACPI-Compliant System
(ISA) 0x00000062 (98)	Microsoft ACPI-Compliant System
(ISA) 0x00000063 (99)	Microsoft ACPI-Compliant System
(ISA) 0x00000064 (100)	Microsoft ACPI-Compliant System
(ISA) 0x00000065 (101)	Microsoft ACPI-Compliant System
(ISA) 0x00000066 (102)	Microsoft ACPI-Compliant System
(ISA) 0x00000067 (103)	Microsoft ACPI-Compliant System
(ISA) 0x00000068 (104)	Microsoft ACPI-Compliant System
(ISA) 0x00000069 (105)	Microsoft ACPI-Compliant System
(ISA) 0x0000006A (106)	Microsoft ACPI-Compliant System
(ISA) 0x0000006B (107)	Microsoft ACPI-Compliant System
(ISA) 0x0000006C (108)	Microsoft ACPI-Compliant System
(ISA) 0x0000006D (109)	Microsoft ACPI-Compliant System
(ISA) 0x0000006E (110)	Microsoft ACPI-Compliant System
(ISA) 0x0000006F (111)	Microsoft ACPI-Compliant System
(ISA) 0x00000070 (112)	Microsoft ACPI-Compliant System
(ISA) 0x00000071 (113)	Microsoft ACPI-Compliant System
(ISA) 0x00000072 (114)	Microsoft ACPI-Compliant System
(ISA) 0x00000073 (115)	Microsoft ACPI-Compliant System
(ISA) 0x00000074 (116)	Microsoft ACPI-Compliant System
(ISA) 0x00000075 (117)	Microsoft ACPI-Compliant System
(ISA) 0x00000076 (118)	Microsoft ACPI-Compliant System
(ISA) 0x00000077 (119)	Microsoft ACPI-Compliant System
(ISA) 0x00000078 (120)	Microsoft ACPI-Compliant System

 (ISA) 0x00000079 (121)	Microsoft ACPI-Compliant System
 (ISA) 0x0000007A (122)	Microsoft ACPI-Compliant System
 (ISA) 0x0000007B (123)	Microsoft ACPI-Compliant System
 (ISA) 0x0000007C (124)	Microsoft ACPI-Compliant System
 (ISA) 0x0000007D (125)	Microsoft ACPI-Compliant System
 (ISA) 0x0000007E (126)	Microsoft ACPI-Compliant System
 (ISA) 0x0000007F (127)	Microsoft ACPI-Compliant System
 (ISA) 0x00000080 (128)	Microsoft ACPI-Compliant System
 (ISA) 0x00000081 (129)	Microsoft ACPI-Compliant System
 (ISA) 0x00000082 (130)	Microsoft ACPI-Compliant System
 (ISA) 0x00000083 (131)	Microsoft ACPI-Compliant System
 (ISA) 0x00000084 (132)	Microsoft ACPI-Compliant System
 (ISA) 0x00000085 (133)	Microsoft ACPI-Compliant System
 (ISA) 0x00000086 (134)	Microsoft ACPI-Compliant System
 (ISA) 0x00000087 (135)	Microsoft ACPI-Compliant System
 (ISA) 0x00000088 (136)	Microsoft ACPI-Compliant System
 (ISA) 0x00000089 (137)	Microsoft ACPI-Compliant System
 (ISA) 0x0000008A (138)	Microsoft ACPI-Compliant System
 (ISA) 0x0000008B (139)	Microsoft ACPI-Compliant System
 (ISA) 0x0000008C (140)	Microsoft ACPI-Compliant System
 (ISA) 0x0000008D (141)	Microsoft ACPI-Compliant System
 (ISA) 0x0000008E (142)	Microsoft ACPI-Compliant System
 (ISA) 0x0000008F (143)	Microsoft ACPI-Compliant System
 (ISA) 0x00000090 (144)	Microsoft ACPI-Compliant System
 (ISA) 0x00000091 (145)	Microsoft ACPI-Compliant System
 (ISA) 0x00000092 (146)	Microsoft ACPI-Compliant System
 (ISA) 0x00000093 (147)	Microsoft ACPI-Compliant System
 (ISA) 0x00000094 (148)	Microsoft ACPI-Compliant System
 (ISA) 0x00000095 (149)	Microsoft ACPI-Compliant System
 (ISA) 0x00000096 (150)	Microsoft ACPI-Compliant System
 (ISA) 0x00000097 (151)	Microsoft ACPI-Compliant System
 (ISA) 0x00000098 (152)	Microsoft ACPI-Compliant System
 (ISA) 0x00000099 (153)	Microsoft ACPI-Compliant System
 (ISA) 0x0000009A (154)	Microsoft ACPI-Compliant System
 (ISA) 0x0000009B (155)	Microsoft ACPI-Compliant System
 (ISA) 0x0000009C (156)	Microsoft ACPI-Compliant System
 (ISA) 0x0000009D (157)	Microsoft ACPI-Compliant System
 (ISA) 0x0000009E (158)	Microsoft ACPI-Compliant System
 (ISA) 0x0000009F (159)	Microsoft ACPI-Compliant System
 (ISA) 0x000000A0 (160)	Microsoft ACPI-Compliant System
 (ISA) 0x000000A1 (161)	Microsoft ACPI-Compliant System
 (ISA) 0x000000A2 (162)	Microsoft ACPI-Compliant System
 (ISA) 0x000000A3 (163)	Microsoft ACPI-Compliant System
 (ISA) 0x000000A4 (164)	Microsoft ACPI-Compliant System
 (ISA) 0x000000A5 (165)	Microsoft ACPI-Compliant System
 (ISA) 0x000000A6 (166)	Microsoft ACPI-Compliant System
 (ISA) 0x000000A7 (167)	Microsoft ACPI-Compliant System
 (ISA) 0x000000A8 (168)	Microsoft ACPI-Compliant System
 (ISA) 0x000000A9 (169)	Microsoft ACPI-Compliant System
 (ISA) 0x000000AA (170)	Microsoft ACPI-Compliant System
 (ISA) 0x000000AB (171)	Microsoft ACPI-Compliant System
 (ISA) 0x000000AC (172)	Microsoft ACPI-Compliant System
 (ISA) 0x000000AD (173)	Microsoft ACPI-Compliant System
 (ISA) 0x000000AE (174)	Microsoft ACPI-Compliant System
 (ISA) 0x000000AF (175)	Microsoft ACPI-Compliant System

(ISA) 0x000000B0 (176)	Microsoft ACPI-Compliant System
(ISA) 0x000000B1 (177)	Microsoft ACPI-Compliant System
(ISA) 0x000000B2 (178)	Microsoft ACPI-Compliant System
(ISA) 0x000000B3 (179)	Microsoft ACPI-Compliant System
(ISA) 0x000000B4 (180)	Microsoft ACPI-Compliant System
(ISA) 0x000000B5 (181)	Microsoft ACPI-Compliant System
(ISA) 0x000000B6 (182)	Microsoft ACPI-Compliant System
(ISA) 0x000000B7 (183)	Microsoft ACPI-Compliant System
(ISA) 0x000000B8 (184)	Microsoft ACPI-Compliant System
(ISA) 0x000000B9 (185)	Microsoft ACPI-Compliant System
(ISA) 0x000000BA (186)	Microsoft ACPI-Compliant System
(ISA) 0x000000BB (187)	Microsoft ACPI-Compliant System
(ISA) 0x000000BC (188)	Microsoft ACPI-Compliant System
(ISA) 0x000000BD (189)	Microsoft ACPI-Compliant System
(ISA) 0x000000BE (190)	Microsoft ACPI-Compliant System
(PCI) 0x0000000A (10)	Intel(R) 6 Series/C200 Series Chipset Family SMBus Controller - 1C22
(PCI) 0x00000010 (16)	Intel(R) 6 Series/C200 Series Chipset Family USB Enhanced Host Controller - 1C2D
(PCI) 0x00000010 (16)	Intel(R) Management Engine Interface
(PCI) 0x00000010 (16)	PCI standard PCI Express to PCI/PCI-X Bridge
(PCI) 0x00000013 (19)	Intel(R) 6 Series/C200 Series Chipset Family 6 Port SATA AHCI Controller - 1C03
(PCI) 0x00000016 (22)	High Definition Audio Controller
(PCI) 0x00000017 (23)	Intel(R) 6 Series/C200 Series Chipset Family USB Enhanced Host Controller - 1C26
(PCI) 0xFFFFFFF7 (-9)	Realtek PCIe GBE Family Controller #3
(PCI) 0xFFFFFFFF8 (-8)	Intel(R) 82579LM Gigabit Network Connection
(PCI) 0xFFFFFFFF9 (-7)	Intel(R) HD Graphics Family
(PCI) 0xFFFFFFFFFA (-6)	Intel(R) 6 Series/C200 Series Chipset Family PCI Express Root Port 5 - 1C18
(PCI) 0xFFFFFFFFFB (-5)	Intel(R) 6 Series/C200 Series Chipset Family PCI Express Root Port 2 - 1C12
(PCI) 0xFFFFFFFFFC (-4)	Intel(R) 6 Series/C200 Series Chipset Family PCI Express Root Port 1 - 1C10
(PCI) 0xFFFFFFFFFD (-3)	Xeon E3-1200/2nd Generation Intel(R) Core(TM) Processor Family PCI Express Controller - 0109
(PCI) 0xFFFFFFFFFE (-2)	Xeon E3-1200/2nd Generation Intel(R) Core(TM) Processor Family PCI Express Root Port - 0101

## B.4 DMA Channel Assignments

-  Direct memory access (DMA)
-  4 Direct memory access controller