

# ACP-1074

---

Infotainment Multi-Touch Panel PC

User's Manual 2<sup>nd</sup> Ed

## Copyright Notice

---

This document is copyrighted, 2016. All rights are reserved. The original manufacturer reserves the right to make improvements to the products described in this manual at any time without notice.

No part of this manual may be reproduced, copied, translated, or transmitted in any form or by any means without the prior written permission of the original manufacturer. Information provided in this manual is intended to be accurate and reliable. However, the original manufacturer assumes no responsibility for its use, or for any infringements upon the rights of third parties that may result from its use.

The material in this document is for product information only and is subject to change without notice. While reasonable efforts have been made in the preparation of this document to assure its accuracy, AAEMON assumes no liabilities resulting from errors or omissions in this document, or from the use of the information contained herein.

AAEMON reserves the right to make changes in the product design without notice to its users.

## Acknowledgement

---

All other products' name or trademarks are properties of their respective owners.

- Microsoft Windows is a registered trademark of Microsoft Corp.
- Intel, Pentium, Celeron, and Xeon are registered trademarks of Intel Corporation
- Core, Atom are trademarks of Intel Corporation
- ITE is a trademark of Integrated Technology Express, Inc.
- IBM, PC/AT, PS/2, and VGA are trademarks of International Business Machines Corporation.

All other product names or trademarks are properties of their respective owners.

## Packing List

---

Before setting up your product, please make sure the following items have been shipped:

Item	Quantity
● ACP-1074	1
● RJ-45 COM port cable	2
● Power adapter	1
● VESA mount	1 set
● Panel mount	1 set
● Product DVD with User's Manual (in pdf) and drivers	1

If any of these items are missing or damaged, please contact your distributor or sales representative immediately.

## About this Document

---

This User's Manual contains all the essential information, such as detailed descriptions and explanations on the product's hardware and software features (if any), its specifications, dimensions, jumper/connector settings/definitions, and driver installation instructions (if any), to facilitate users in setting up their product.

Users may refer to the [AAEON.com](http://AAEON.com) for the latest version of this document.

## Safety Precautions

---

Please read the following safety instructions carefully. It is advised that you keep this manual for future references

1. All cautions and warnings on the device should be noted.
2. All cables and adapters supplied by AAEON are certified and in accordance with the material safety laws and regulations of the country of sale. Do not use any cables or adapters not supplied by AAEON to prevent system malfunction or fires.
3. Make sure the power source matches the power rating of the device.
4. Position the power cord so that people cannot step on it. Do not place anything over the power cord.
5. Always completely disconnect the power before working on the system's hardware.
6. No connections should be made when the system is powered as a sudden rush of power may damage sensitive electronic components.
7. If the device is not to be used for a long time, disconnect it from the power supply to avoid damage by transient over-voltage.
8. Always disconnect this device from any AC supply before cleaning.
9. While cleaning, use a damp cloth instead of liquid or spray detergents.
10. Make sure the device is installed near a power outlet and is easily accessible.
11. Keep this device away from humidity.
12. Place the device on a solid surface during installation to prevent falls
13. Do not cover the openings on the device to ensure optimal heat dissipation.
14. Watch out for high temperatures when the system is running.
15. Do not touch the heat sink or heat spreader when the system is running
16. Never pour any liquid into the openings. This could cause fire or electric shock.

17. As most electronic components are sensitive to static electrical charge, be sure to ground yourself to prevent static charge when installing the internal components. Use a grounding wrist strap and contain all electronic components in any static-shielded containers.
18. If any of the following situations arises, please the contact our service personnel:
  - i. Damaged power cord or plug
  - ii. Liquid intrusion to the device
  - iii. Exposure to moisture
  - iv. Device is not working as expected or in a manner as described in this manual
  - v. The device is dropped or damaged
  - vi. Any obvious signs of damage displayed on the device
19. **DO NOT LEAVE THIS DEVICE IN AN UNCONTROLLED ENVIRONMENT WITH TEMPERATURES BEYOND THE DEVICE'S PERMITTED STORAGE TEMPERATURES (SEE CHAPTER 1) TO PREVENT DAMAGE.**

### **Warning!**



This device complies with Part 15 FCC Rules. Operation is subject to the following two conditions: (1) this device may not cause harmful interference, and (2) this device must accept any interference received including interference that may cause undesired operation.

### **Caution:**

*There is a danger of explosion if the battery is incorrectly replaced. Replace only with the same or equivalent type recommended by the manufacturer. Dispose of used batteries according to the manufacturer's instructions and your local government's recycling or disposal directives.*

### **Attention:**

*Il y a un risque d'explosion si la batterie est remplacée de façon incorrecte. Ne la remplacer qu'avec le même modèle ou équivalent recommandé par le constructeur. Recycler les batteries usées en accord avec les instructions du fabricant et les directives gouvernementales de recyclage.*



# China RoHS Requirements (CN)

产品中有毒有害物质或元素名称及含量

AAEON Panel PC/ Workstation

部件名称	有毒有害物质或元素					
	铅 (Pb)	汞 (Hg)	镉 (Cd)	六价铬 (Cr(VI))	多溴联苯 (PBB)	多溴二苯醚 (PBDE)
印刷电路板 及其电子组件	○	○	○	○	○	○
外部信号 连接器及线材	○	○	○	○	○	○
外壳	○	○	○	○	○	○
中央处理器 与内存	○	○	○	○	○	○
硬盘	○	○	○	○	○	○
液晶模块	○	○	○	○	○	○
光驱	○	○	○	○	○	○
触控模块	○	○	○	○	○	○
电源	○	○	○	○	○	○

**O:** 表示该有毒有害物质在该部件所有均质材料中的含量均在 SJ/T 11363-2006 标准规定的限量要求以下。

**X:** 表示该有毒有害物质至少在该部件的某一均质材料中的含量超出 SJ/T 11363-2006 标准规定的限量要求。

备注:

- 一、此产品所标示之环保使用期限，系指在一般正常使用状况下。
- 二、上述部件物质中央处理器、内存、硬盘、光驱、触控模块为选购品。

## China RoHS Requirement (EN)

Poisonous or Hazardous Substances or Elements in Products

AAEON Panel PC/ Workstation

Component	Poisonous or Hazardous Substances or Elements					
	Lead (Pb)	Mercury (Hg)	Cadmium (Cd)	Hexavalent Chromium (Cr(VI))	Polybrominated Biphenyls (PBB)	Polybrominated Diphenyl Ethers (PBDE)
PCB & Other Components	○	○	○	○	○	○
Wires & Connectors for External Connections	○	○	○	○	○	○
Chassis	○	○	○	○	○	○
CPU & RAM	○	○	○	○	○	○
Hard Disk	○	○	○	○	○	○
LCD	○	○	○	○	○	○
Optical Drive	○	○	○	○	○	○
Touchscreen	○	○	○	○	○	○
PSU	○	○	○	○	○	○
<p>O: The quantity of poisonous or hazardous substances or elements found in each of the component's parts is below the SJ/T 11363-2006-stipulated requirement.</p> <p>X: The quantity of poisonous or hazardous substances or elements found in at least one of the component's parts is beyond the SJ/T 11363-2006-stipulated requirement.</p> <p>Note: The Environment Friendly Use Period as labeled on this product is applicable under normal usage only</p>						

# Table of Contents

---

- Chapter 1 - Product Specifications..... 1**
  - 1.1 Specifications..... 2
- Chapter 2 – Hardware Information ..... 5**
  - 2.1 Dimensions ..... 6
  - 2.2 List of Jumpers ..... 10
    - 2.2.1 AT/ATX Mode Selection (JP1)..... 11
    - 2.2.2 LVDS BKLT Control Selection (JP2)..... 11
    - 2.2.3 LVDS Power Selection (JP3) ..... 11
    - 2.2.4 LVDS BKLT Power Selection (JP4) ..... 12
    - 2.2.5 Clear CMOS Jumper (JP5) ..... 12
    - 2.2.6 Dry and Wet Contact Digital Input Power Selection (JP6)..... 12
    - 2.2.7 Dry and Wet Contact Digital Output Power Selection (JP7) ..... 13
  - 2.3 List of Connectors ..... 14
    - 2.3.1 HDMI Display (CN1)..... 15
    - 2.3.2 USB 3.0 Connector (CN2)..... 16
    - 2.3.3 COM2 RS-232/422/485 Connector (CN4)..... 16
    - 2.3.4 COM3 RS-232 I/F (CN16) ..... 17
    - 2.3.5 COM1 RS-232/422/485 Connector (CN17)..... 17
    - 2.3.6 Dry and Wet Contact Digital Input (CN23)..... 18
    - 2.3.7 Dry and Wet Contact Digital Output (CN24) ..... 20
    - 2.3.8 RJ-45 Ethernet Port (CN26)..... 21
    - 2.3.9 RJ-45 Ethernet Port (CN27)..... 21
    - 2.3.10 USB 2.0 Port 1 Connector (USB1) ..... 22
    - 2.3.11 USB 2.0 Port 2 Connector (USB2) ..... 22
    - 2.3.12 USB 2.0 Port 3 Connector (USB3) ..... 22
    - 2.3.13 LAN1 Connector (CN37)..... 23

2.3.14	DDR3L SODIMM Slot (DIMM1).....	23
2.3.15	Half Size MiniCard Slot (PCIE1).....	23
2.3.16	PCI-E Full Size MiniCard Slot (PCIE2) .....	25
2.3.17	COM-to-RJ-45 Converter Cable (For COM1 & COM2).....	27
2.4	Mounting the Panel .....	29
<b>Chapter 3 - AMI BIOS Setup.....</b>		<b>31</b>
3.1	System Test and Initialization .....	32
3.2	AMI BIOS Setup.....	33
3.3	Setup Submenu: Main.....	34
3.4	Setup Submenu: Advanced .....	35
3.4.1	Advanced: CPU Configuration.....	36
3.4.2	Advanced: IDE Configuration .....	37
3.4.3	Advanced: USB Configuration .....	38
3.4.4	Advanced: Hardware Monitor .....	39
3.4.5	Advanced: Dynamic Digital IO Configuration .....	40
3.4.6	Advanced: Power Management.....	41
3.4.7	Advanced: SIO Configuration .....	42
3.5	Setup submenu: Chipset.....	45
3.5.1	Chipset: North Bridge.....	46
3.5.2	South Bridge.....	49
3.6	Security.....	50
3.7	Setup submenu: Boot.....	51
3.7.1	BBS Priorities.....	52
3.8	Setup submenu: Exit.....	53
<b>Chapter 4 – Drivers Installation .....</b>		<b>54</b>
4.1	Product CD/DVD.....	55
<b>Appendix A - Watchdog Timer Programming.....</b>		<b>57</b>
A.1	Watchdog Timer Initial Program.....	58

<b>Appendix B - I/O Information</b> .....	<b>63</b>
B.1 I/O Address Map.....	64
B.2 Memory Address Map.....	66
B.3 IRQ Mapping Chart.....	67
<b>Appendix C – Digital I/O Ports</b> .....	<b>75</b>
C.1 DI/O Programming.....	76
C.2 Digital I/O Register.....	77
C.3 Digital I/O Sample Program.....	78

# Chapter 1

---

Product Specifications

## 1.1 Specifications

---

### System

- **Processor** Intel® Atom™ J1900/N2807 Processor
- **System Memory** 204-pin DDR3L 1333 SODIMM x 1, Up to 8 GB (Pre-installed 2 GB)
- **LCD/CRT Controller** LVDS
- **I/O Port** USB 3.0 x 1  
USB 2.0 x 3  
LAN x 2  
DIO x 6 (DI x 4, DO x 2, w/o isolation)  
RJ-45 x 2 for RS-232/422/485 (BIOS Selection)  
HDMI x 1  
Antenna Hole x 2  
Power Button x 1  
Lockable Power Connector x 1
- **Storage** mSATA (half-size) x 1
- **Expansion Slot** MiniCard (Full-size) x 1 (mSATA only), MiniCard (Half-size) x 1
- **OS Support** Windows® Embedded Standard 8 32/64-bit,  
Windows® Embedded Standard 7 32/64-bit,  
Windows® 10 32/64-bit  
Windows® 8.1 32/64-bit

**Note:**

If discoloration is observed with the default wallpaper, it is recommended to change to a custom wallpaper, or perform the appropriate

adjustments in the Intel HD Graphics Control Panel. To do this, go to Display -> Color, adjust Contrast from the default 50 to 49 or 51.

Windows® 7 32/64-bit

Linux by Fedora kernel 2.6.3 up

## Mechanical

● Construction	IP65/ NEMA4-rated Aluminum Front Bezel
● Mounting	VESA 75 Panel Mount
● Dimension (W x H x D)	196 x 134 x 30 mm (7.71 x 5.27 x 1.18")
● Carton Dimension (W x H x D)	345 x 200 x 245 mm (13.58 x 7.87 x 9.64")
● Net Weight	1.2 kg (2.6 lb)
● Gross Weight	2.5 kg (5.5 lb)

## Environmental

● Operating Temperature	0 ~ 50°C (32 ~ 122°F) ( mSATA/ J1900 ) - with 0.5 m/s airflow (compliance to IEC 68-2-14)
● Storage Temperature	5 ~ 95% @ 40°C, non-condensing
● Operating Humidity	10 ~ 90% @ 40°C, non-condensing
● Anti-Vibration	3 G <sub>rms</sub> / 5~500 Hz/ operation (mSATA)
● Anti-Shock	20 G peak acceleration (11 msec. duration, mSATA)
● EMC	CE/FCC Class A



## Power Supply

- DC Input DC 12 V

## LCD

- Display Type 7" WXGA LED
- Max. Resolution 1024 x 600
- Max Colors 262 K
- Luminance (cd/m<sup>2</sup>)<sup>4</sup> 250 nits
- Contrast Ratio 700:1
- Viewing Angle 150° (H), 145° (V)

## Touchscreen

- Type USB
- Resolution 2048 x 2048
- Light Transmission >86 %

# Chapter 2

---

Hardware Information



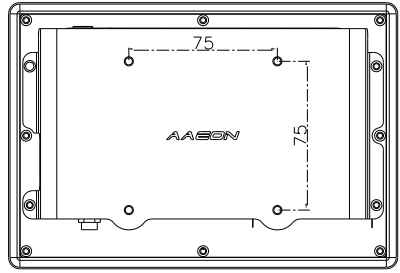
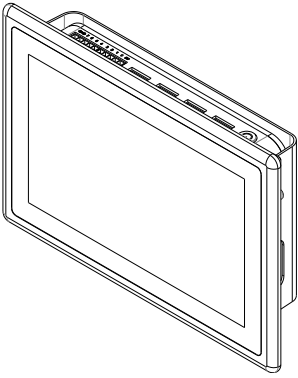

OPENING SIZE=191\*129mm

With VESA mount

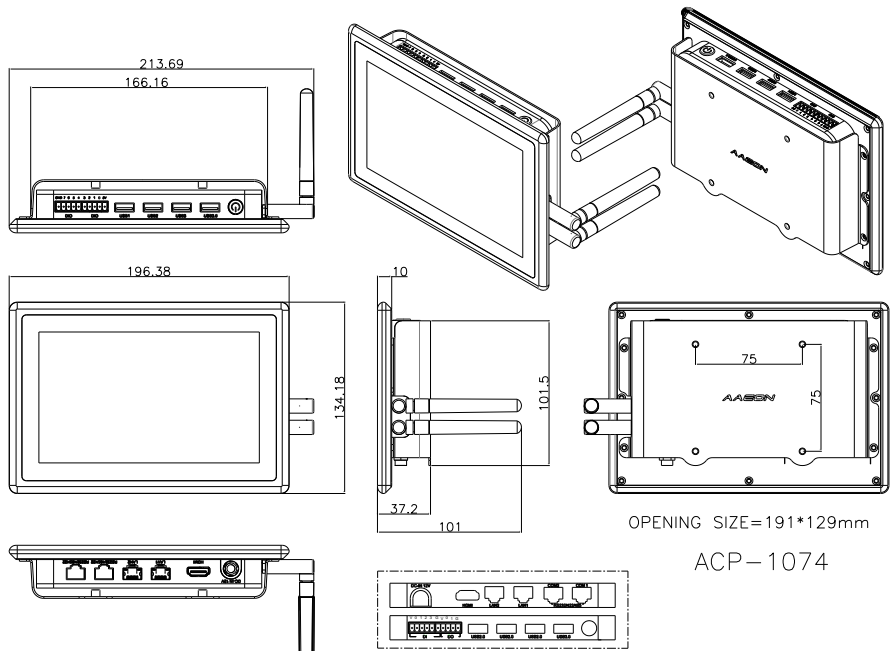

With Wall Mount

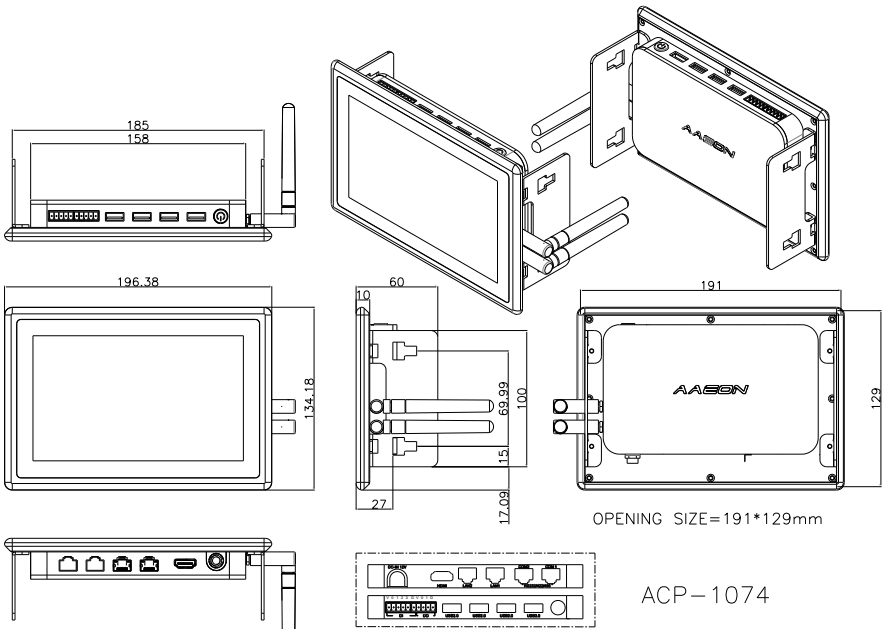

ACP-1074

## 2.2 List of Jumpers

---

Please refer to the table below for all of the board's jumpers that you can configure for your application

Label	Function
JP1	AT/ATX Mode Selection
JP2	LVDS BKLT Control Selection
JP3	LVDS Power Selection
JP4	LVDS BKLT Control Selection
JP5	Clear CMOS Jumper
JP6	Dry and Wet Contact Digital Input Power Selection
JP7	Dry and Wet Contact Digital Output Power Selection

### 2.2.1 AT/ATX Mode Selection (JP1)

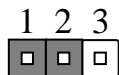

ATX Mode (Default)

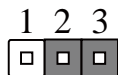

AT Mode

Pin	Function
1-2	ATX Mode (Default)
2-3	AT Mode

### 2.2.2 LVDS BKLT Control Selection (JP2)

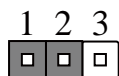

VR Mode

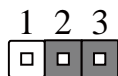

PWM Mode (Default)

Pin	Function
1-2	VR Mode
2-3	PWM Mode (Default)

### 2.2.3 LVDS Power Selection (JP3)

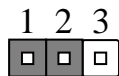

5 V

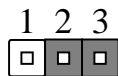

3.3 V (Default)

Pin	Function
1-2	5 V
2-3	3.3 V (Default)



### 2.2.4 LVDS BKLT Power Selection (JP4)

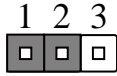

12 V

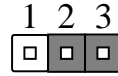

5 V (Default)

Pin	Function
1-2	12 V
2-3	5 V (Default)

### 2.2.5 Clear CMOS Jumper (JP5)

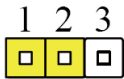

Normal (Default)

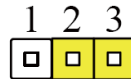

Clear CMOS

Pin	Function
1-2	Normal (Default)
2-3	Clear CMOS

### 2.2.6 Dry and Wet Contact Digital Input Power Selection (JP6)

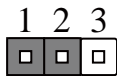

Wet Contact Digital Input

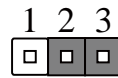

Dry Contact Digital Input (Default)

Pin	Function
1-2	Wet Contact Digital Input
2-3	Dry Contact Digital Input (Default)

## 2.2.7 Dry and Wet Contact Digital Output Power Selection (JP7)

---

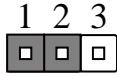

Wet Contact Digital Output

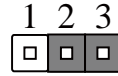

Dry Contact Digital Output (Default)

Pin	Function
1-2	Wet Contact Digital Output
2-3	Dry Contact Digital Output (Default)

## 2.3 List of Connectors

---

Please refer to the table below for all of the board's connectors that you can configure for your application

Label	Function
CN1	HDMI Display
CN2	USB 3.0 Connector
CN4	COM2 RS-232/422/485
CN16	COM3 RS-232 I/F
CN17	COM1 RS-232/422/485
CN22	BIOS SPI Flash Header
CN23	Dry and Wet Contact Digital Input
CN24	Dry and Wet Contact Digital Output
CN26	RJ-45 Ethernet Port
CN27	RJ-45 Ethernet Port
USB1	USB 2.0 Port 1 Connector
USB2	USB 2.0 Port 2 Connector
USB3	USB 2.0 Port 3 Connector
BAT1	Battery Connector
DIMM1	DDR3L SODIMM Slot
PCIE1	mSATA Half Size MiniCard Slot
PCIE2	PCI-E Full Size MiniCard Slot

### 2.3.1 HDMI Display (CN1)

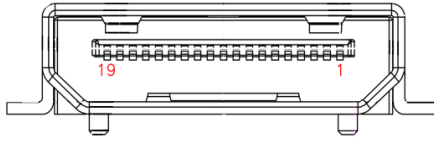

Pin	Pin Name	Signal Type	Signal Level
1	HDMI_TX2+		DIFF
2	GND	GND	
3	HDMI_TX2-		DIFF
4	HDMI_TX1+		DIFF
5	GND		GND
6	HDMI_TX1-		DIFF
7	HDMI_TX0+		DIFF
8	GND		GND
9	HDMI_TX0-		DIFF
10	HDMI_CLK+		DIFF
11	GND		GND
12	HDMI_CLK-		DIFF
13	NC		NC
14	NC		NC
15	HDMI_DDC_CLK	I/O	+5V
16	HDMI_DDC_DATA	I/O	+5V
17	GND		GND
18	HDMI_PWR	PWR	+5V
19	HDMI_HPD		IN

### 2.3.2 USB 3.0 Connector (CN2)

Pin	Pin Name	Signal Type	Signal Level
1	+5V	PWR	+5V
2	USB_D-	DIFF	
3	USB_D+	DIFF	
4	GND	GND	
5	USB3.0 RX-	DIFF	
6	USB3.0 RX+	DIFF	
7	GND	GND	
8	USB3.0 TX-	DIFF	
9	USB3.0 TX+	DIFF	

### 2.3.3 COM2 RS-232/422/485 Connector (CN4)

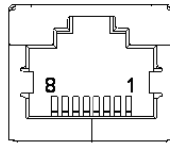

Pin	RS-232	RS-422	RS-485
1	DSR		
2	RTS		
3	GND		
4	TX	RX+	
5	RX	TX+	DATA+
6	DCD	TX-	DATA-
7	CTS		

### 2.3.4 COM3 RS-232 I/F (CN16)

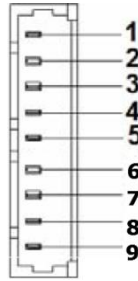

Pin	RS-232
1	DCD
2	DSR
3	RX
4	RTS
5	TX
6	CTS
7	DTR
8	RI
9	GND

### 2.3.5 COM1 RS-232/422/485 Connector (CN17)

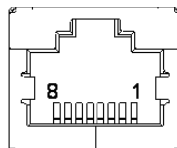

Pin	RS-232	RS-422	RS-485
1	DSR		
2	RTS		
3	GND		
4	TX	RX+	
5	RX	TX+	DATA+
6	DCD	TX-	DATA-
7	CTS		
8	DTR	RX	

### 2.3.6 Dry and Wet Contact Digital Input (CN23)

**Digital Input Dry Contact Diagram**

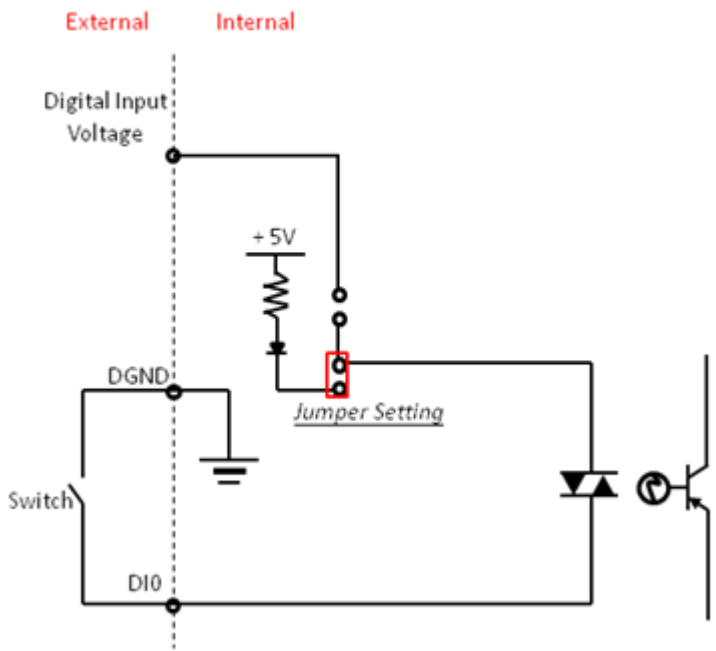

## Digital Input Wet Contact Diagram

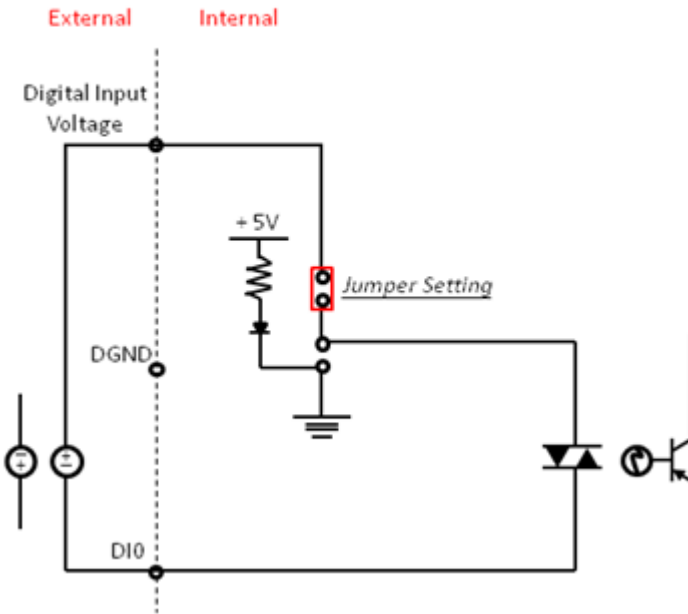

### Dry Contact Wiring

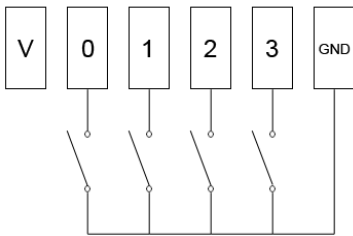

### Wet Contact Wiring

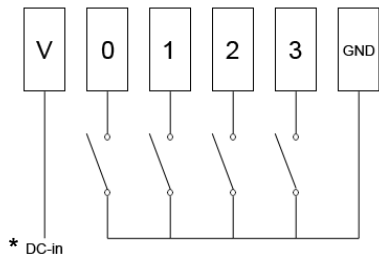

### Digital input voltage range

Max

10 ~ 25 V

Min

5 V

Pin	Pin Name	Signal Type	Signal Level
1	Digital input 3	Input	DRY (5V) WET (3~30V)



2	Digital input 2	Input	DRY (5V) WET (3~30V)
3	Digital input 1	Input	DRY (5V) WET (3~30V)
4	Digital input 0	Input	DRY (5V) WET (3~30V)
5	WET contact POWER	PWR	3~30V

### 2.3.7 Dry and Wet Contact Digital Output (CN24)

Dry Contact Wiring

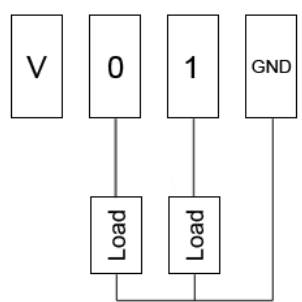

Wet Contact Wiring

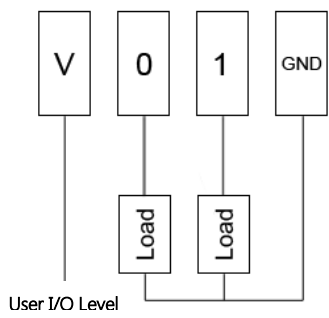

#### Digital output voltage range

Max	Min
30 V	5 V

Pin	Pin Name	Signal Type	Signal Level
1	GND	GND	
2	Digital output 5	Input	Open collector to 30 VDC
3	Digital output 4	Input	Open collector to 30 VDC
4	Digital output POWER	Input	3 ~ 30 V
5	GND	GND	

### 2.3.8 RJ-45 Ethernet Port (CN26)

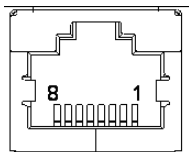

Pin	Pin Name	Signal Type	Signal Level
1	MDI0+	DIFF	
2	MDI0-	DIFF	
3	MDI1+	DIFF	
4	MDI2+	DIFF	
5	MDI2-	DIFF	
6	MDI1-	DIFF	
7	MDI3+	DIFF	
8	MDI3-	DIFF	

### 2.3.9 RJ-45 Ethernet Port (CN27)

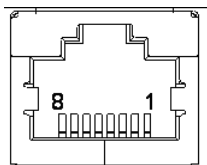

Pin	Pin Name	Signal Type	Signal Level
1	MDI0+	DIFF	
2	MDI0-	DIFF	
3	MDI1+	DIFF	
4	MDI2+	DIFF	
5	MDI2-	DIFF	
6	MDI1-	DIFF	

7	MDI3+	DIFF
8	MDI3-	DIFF

### 2.3.10 USB 2.0 Port 1 Connector (USB1)

Pin	Pin Name	Signal Type	Signal Level
1	+5V	PWR	+5V
2	USB_D-	DIFF	
3	USB_D+	DIFF	
4	GND	GND	

### 2.3.11 USB 2.0 Port 2 Connector (USB2)

Pin	Pin Name	Signal Type	Signal Level
1	+5V	PWR	+5V
2	USB_D-	DIFF	
3	USB_D+	DIFF	
4	GND	GND	

### 2.3.12 USB 2.0 Port 3 Connector (USB3)

Pin	Pin Name	Signal Type	Signal Level
1	+5V	PWR	+5V
2	USB_D-	DIFF	
3	USB_D+	DIFF	
4	GND	GND	

### 2.3.13 LAN1 Connector (CN37)

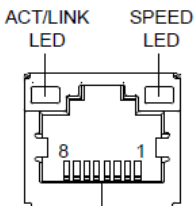

Pin	Signal	Pin	Signal
1	MDIO+	2	MDIO-
3	MDI1+	4	MDI2+
5	MDI2-	6	MDI1-
7	MDI3+	8	MDI3-

### 2.3.14 DDR3L SODIMM Slot (DIMM1)

Standard Specifications

### 2.3.15 Half Size MiniCard Slot (PCIE1)

Pin	Pin Name	Signal Type	Signal Level
1		NC	
2	+3.3V	PWR	+3.3V
3		NC	
4	GND	GND	
5		NC	
6	+1.5V	PWR	+1.5V
7		NC	
8		NC	
9	GND	GND	

10		NC	
11		NC	
12		NC	
13		NC	
14		NC	
15	GND	GND	
16		NC	
17		NC	
18	GND	GND	
19		NC	
20		NC	
21	GND	GND	
22		NC	
23	mSATA RX+	DIFF	
24	+3.3V	PWR	+3.3V
25	mSATA RX-	DIFF	
26	GND	GND	
27	GND	GND	
28	+1.5V	PWR	+1.5V
29	GND	GND	
30	SMB_CLK	I/O	+3.3V
31	mSATA_TX	DIFF	
32	SMB_DATA	I/O	+3.3V
33	mSATA_TX+	DIFF	
34	GND	GND	
35	GND	GND	
36		NC	

37	GND	GND	
38		NC	
39	+3.3V	PWR	+3.3V
40	GND	GND	
41	+3.3V	PWR	+3.3V
42		NC	
43		NC	
44		NC	
45		NC	
46		NC	
47		NC	
48	+1.5V	PWR	+1.5V
49		NC	
50	GND	GND	
51		NC	
52	+3.3V	PWR	+3.3V

### 2.3.16 PCI-E Full Size MiniCard Slot (PCIE2)

Pin	Pin Name	Signal Type	Signal Level
1		NC	
2	+3.3V	PWR	+3.3V
3		NC	
4	GND	GND	
5		NC	
6	+1.5V	PWR	+1.5V
7		NC	

8		NC	
9	GND	GND	
10		NC	
11		NC	
12		NC	
13		NC	
14		NC	
15	GND	GND	
16		NC	
17		NC	
18	GND	GND	
19		NC	
20		NC	
21	GND	GND	
22		NC	
23	PCIE RX-	DIFF	
24	+3.3V	PWR	+3.3V
25	PCIE RX+	DIFF	
26	GND	GND	
27	GND	GND	
28	+1.5V	PWR	+1.5V
29	GND	GND	
30	SMB_CLK	I/O	+3.3V
31	PCIE TX	DIFF	
32	SMB_DATA	I/O	
33	PCIE TX+	DIFF	
34	GND	GND	

35	GND	GND	
36		NC	
37	GND	GND	
38		NC	
39	+3.3V	PWR	+3.3V
40	GND	GND	
41	+3.3V	PWR	+3.3V
42		NC	
43		NC	
44		NC	
45		NC	
46		NC	
47		NC	
48	+1.5V	PWR	+1.5V
49		NC	
50	GND	GND	
51		NC	
52	+3.3V	PWR	+3.3V

### 2.3.17 COM-to-RJ-45 Converter Cable (For COM1 & COM2)





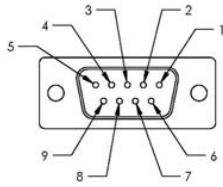

Pin	RS-232	RS-422	RS-485
1	DCD	TX-	DATA-
2	RXD	TX+	DATA+
3	TXD	RX+	
4	DTR	RX-	
5	GND		
6	DSR		
7	RTS		
8	CTS		
9	NA		

## 2.4 Mounting the Panel

Step 1: Get the wallmount brackets and sponge ready.

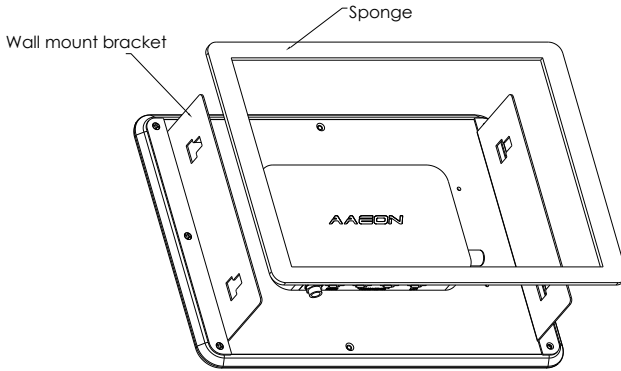

**Step 2:** Remove the six screws (three on each side) at the back and place the wallmount brackets onto the panel. Secure the brackets with the original six screws.

**Step 3:** Place the sponge onto the brackets

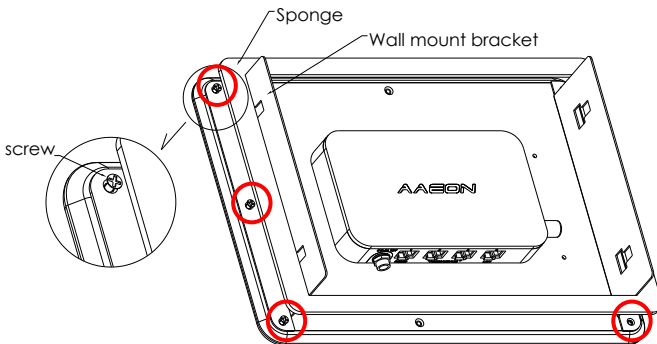

**Step 4:** Insert the display through the surface (opening) where you are going to mount the panel

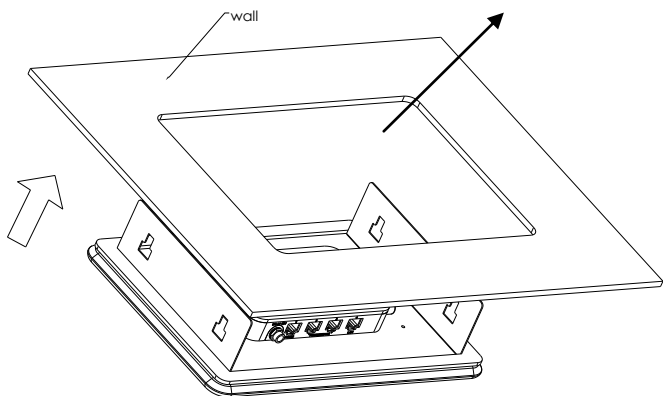

**Step 5:** Attach the mounting clips to the four fillisters on the wallmount brackets and tighten the four M4x60 screws to secure the brackets

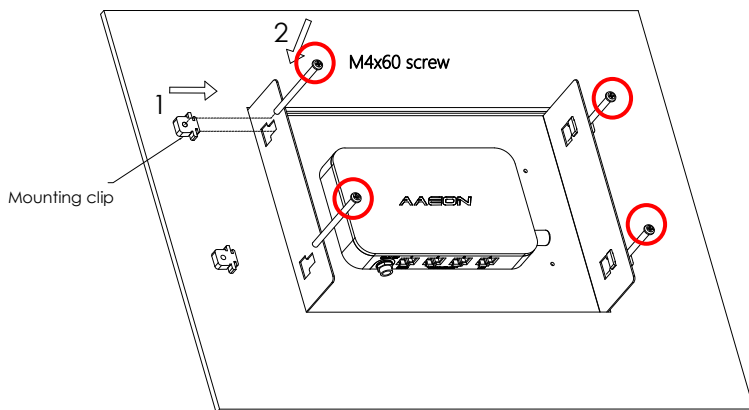

# Chapter 3

---

AMI BIOS Setup

## 3.1 System Test and Initialization

---

The system uses certain routines to perform testing and initialization. If an error, fatal or non-fatal, is encountered, a few short beeps or an error message will be outputted. The board can usually continue the boot up sequence with non-fatal errors.

The system configuration verification routines check the current system configuration against the values stored in the CMOS memory. If they do not match, an error message will be outputted, in which case you will need to run the BIOS setup program to set the configuration information in memory.

There are three situations in which you will need to change the CMOS settings:

- You are starting your system for the first time
- You have changed your system's hardware
- The CMOS memory has lost power and the configuration information is erased

The system's CMOS memory uses a backup battery for data retention, which is to be replaced once emptied.

## 3.2 AMI BIOS Setup

---

The AMI BIOS ROM has a pre-installed Setup program that allows users to modify basic system configurations, which is stored in the battery-backed CMOS RAM and BIOS NVRAM so that the information is retained when the power is turned off.

To enter BIOS Setup, press <Del> or <F2> immediately while your computer is powering up.

The function for each interface can be found below.

**Main** – Date and time can be set here. Press <Tab> to switch between date elements

**Advanced** – Enable/ Disable boot option for legacy network devices

**Chipset** – For hosting bridge parameters

**Boot** – Enable/ Disable quiet Boot Option

**Security** – The setup administrator password can be set here

**Save & Exit** – Save your changes and exit the program

### 3.3 Setup Submenu: Main

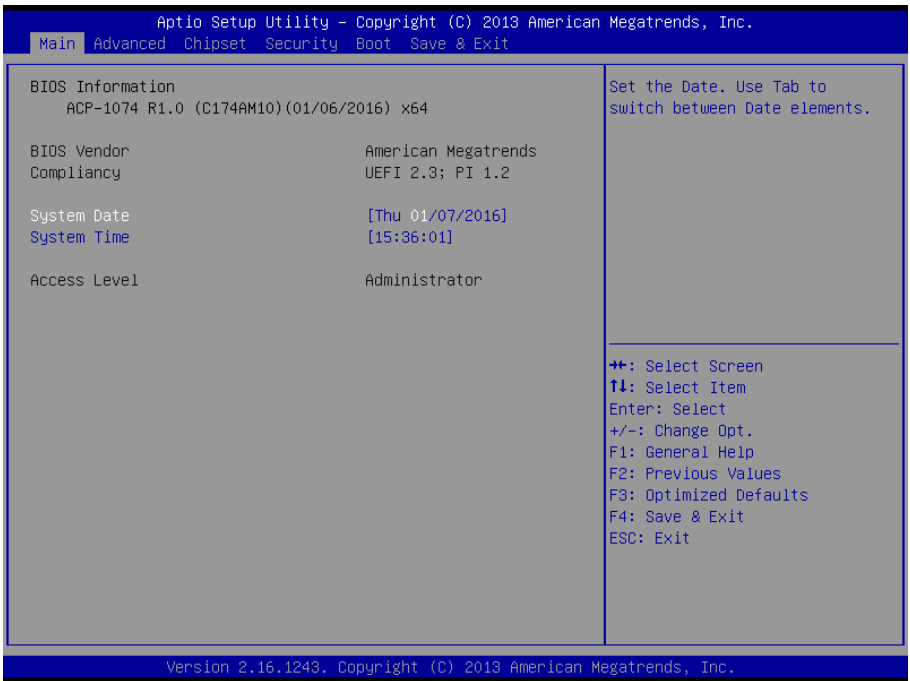

### 3.4 Setup Submenu: Advanced

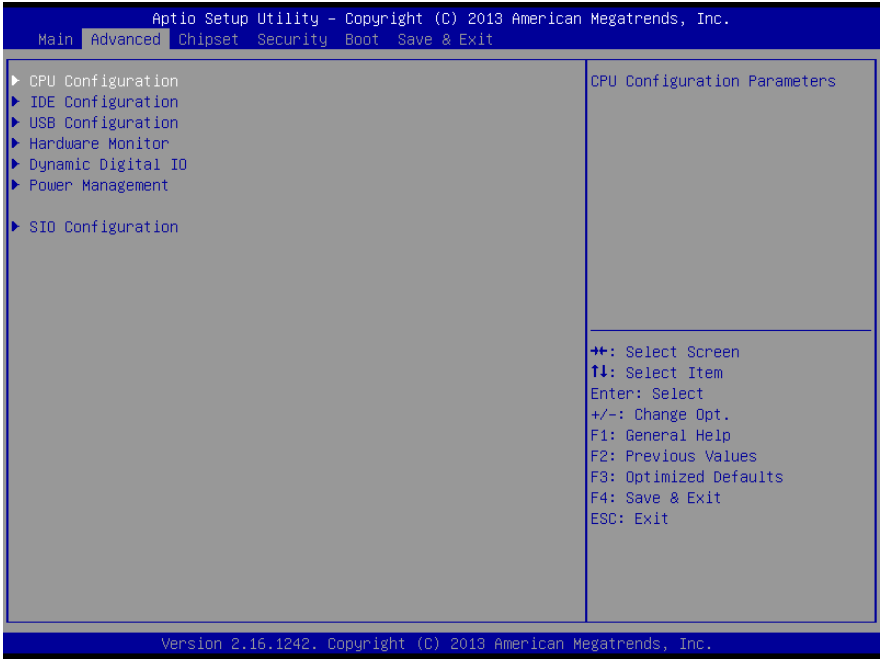



### 3.4.1 Advanced: CPU Configuration

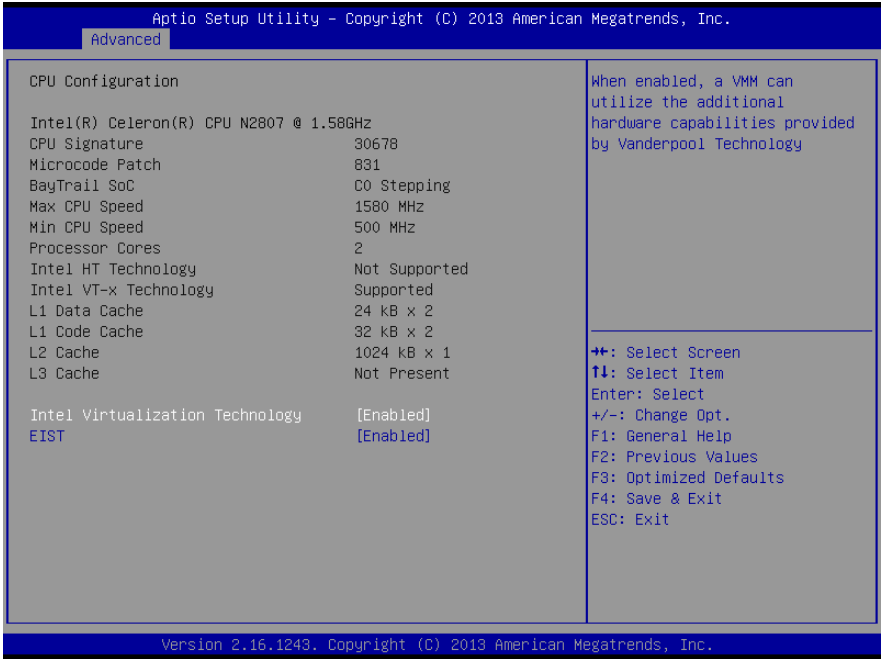

Options summary:

Intel Virtualization Technology	Disabled	
	Enabled	Optimal Default, Failsafe Default
EIST	Disabled	
	Enabled	Optimal Default, Failsafe Default

### 3.4.2 Advanced: IDE Configuration

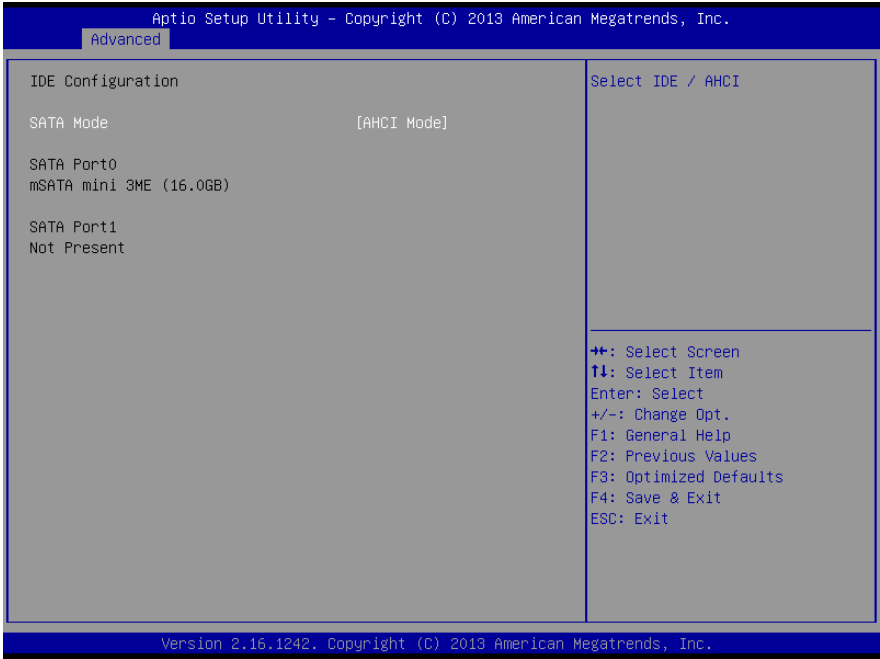

Options summary:

SATA Mode	IDE Mode	Optimal Default, Failsafe Default
	AHCI Mode	

### 3.4.3 Advanced: USB Configuration

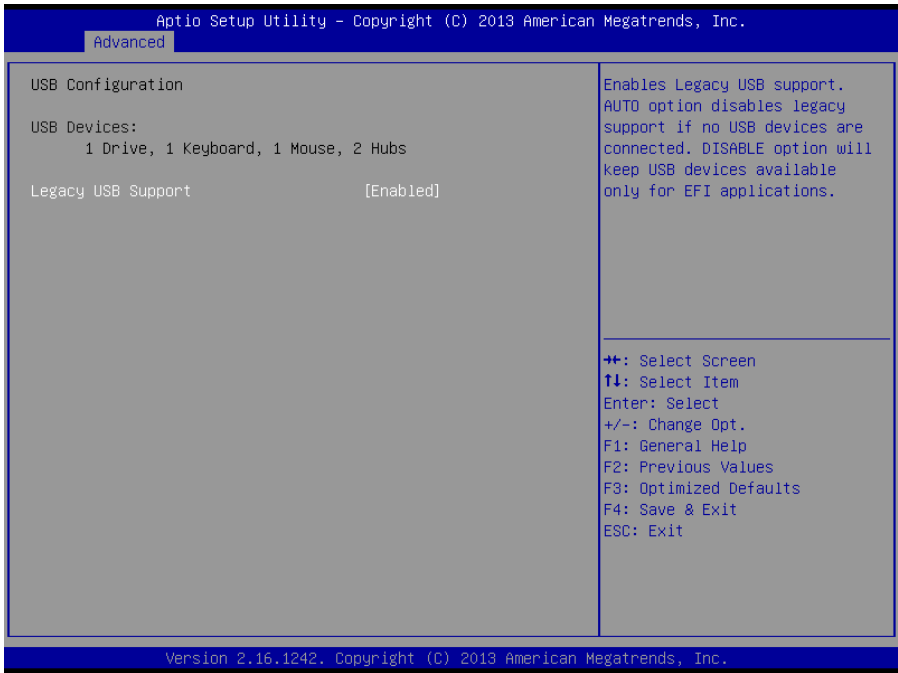

Options summary:

Legacy USB Support	Enabled	Optimal Default, Failsafe Default
	Disabled	
	Auto	
<p>Enables BIOS Support for Legacy USB Support. When enabled, USB can be functional in legacy environment like DOS.          AUTO option disables legacy support if no USB devices are connected</p>		

### 3.4.4 Advanced: Hardware Monitor

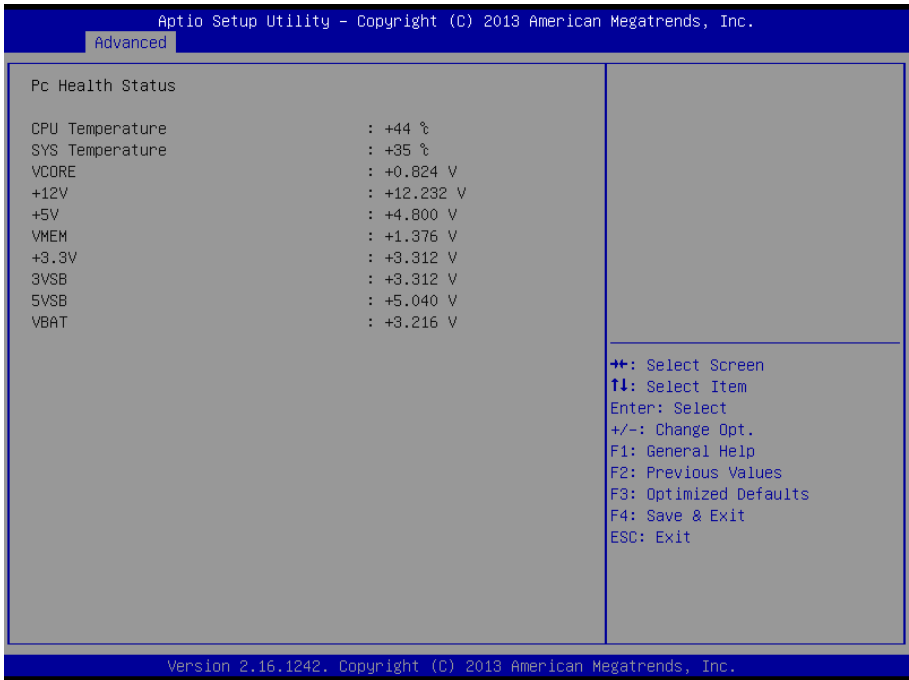

### 3.4.5 Advanced: Dynamic Digital IO Configuration

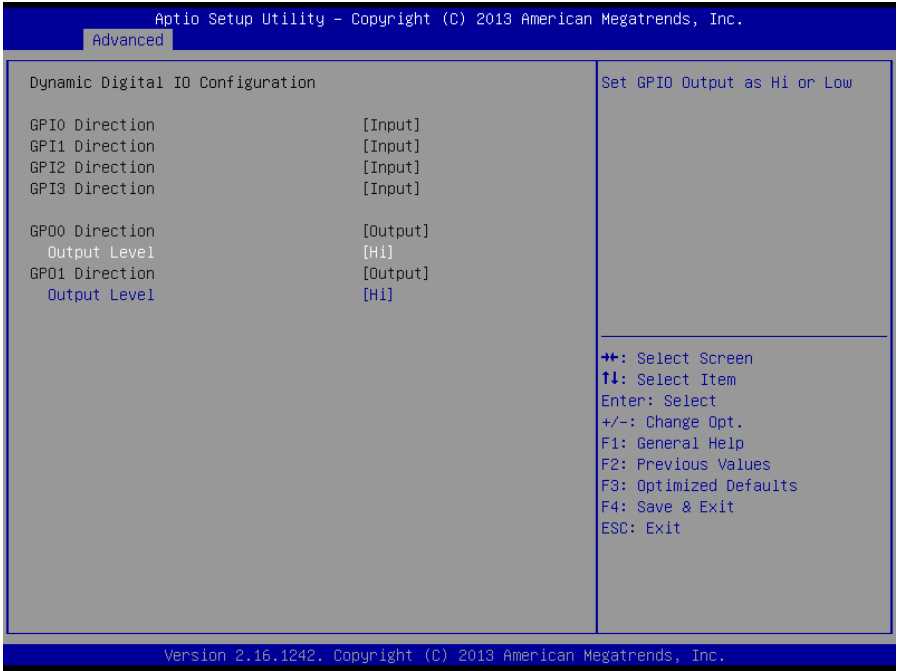

Options summary:

GPO0 Direction [Output]	Low	
Output Level	Hi	Optimal Default, Failsafe Default
GPO1 Direction [Output]	Low	
Output Level	Hi	Optimal Default, Failsafe Default

### 3.4.6 Advanced: Power Management

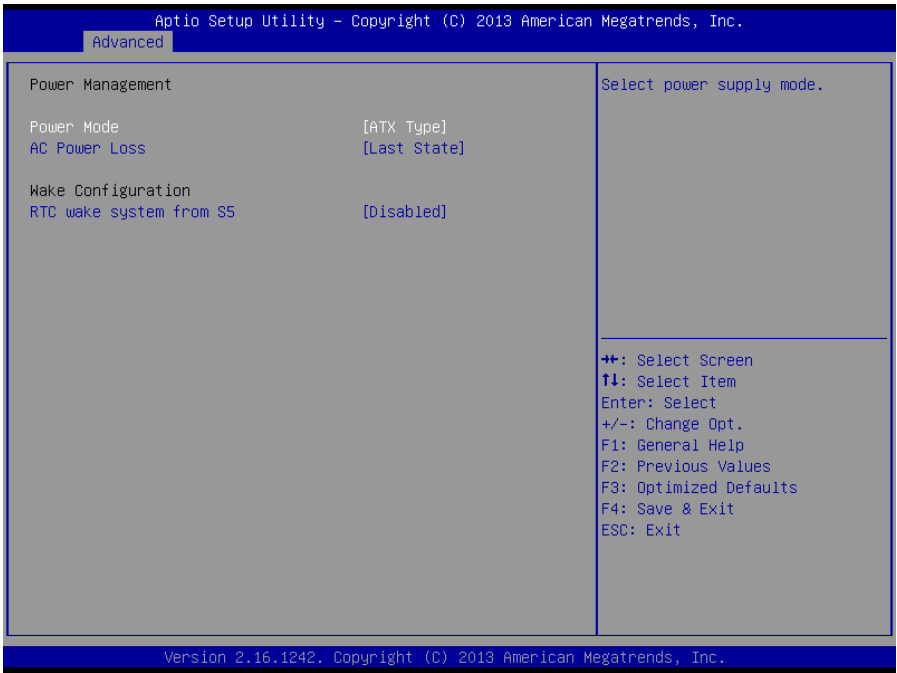

Options summary:

Power Mode	ATX Type	Optimal Default, Failsafe Default
	AT Type	
Select power supply mode.		
AC Power Loss	Last State	Optimal Default, Failsafe Default
	Power On	
	Power Off	
Select power state when power is re-applied after a power failure.		
RTC wake system from S5	Disabled	Optimal Default, Failsafe Default
	Fixed Time	
	Dynamic Time	
Enable or disable System wake on alarm event. When enabled, System will wake on the hr::min::sec specified		

### 3.4.7 Advanced: SIO Configuration



### 3.4.7.1 SIO Configuration: Serial Port 1 Configuration

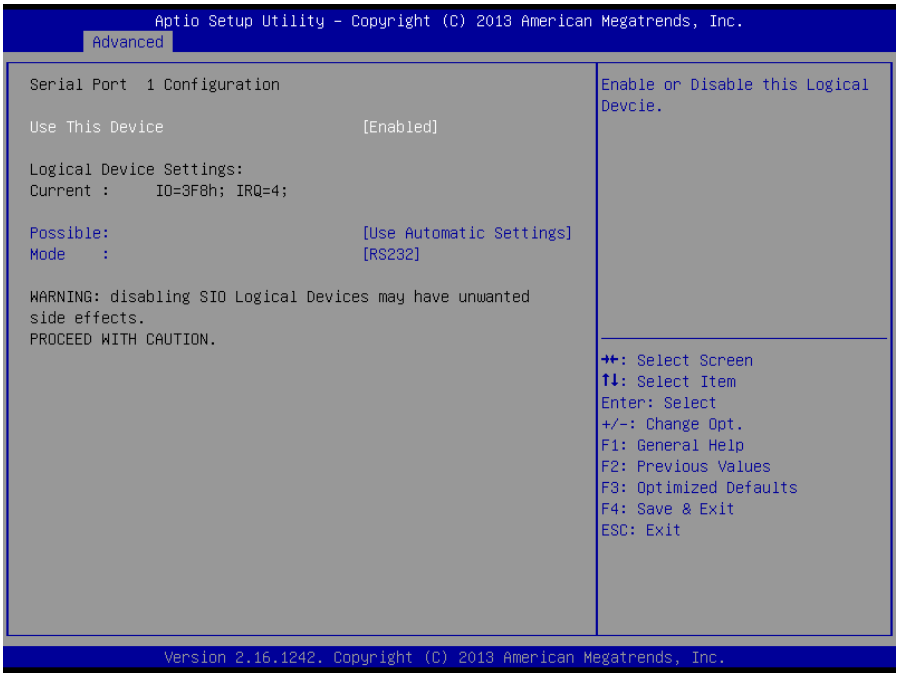

Options summary:

Use This Device	Disabled	Optimal Default, Failsafe Default
	Enabled	
En/Disable Serial Port (COM)		
Possible:	Use Automatic Settings	Optimal Default, Failsafe Default
	IO=3F8; IRQ=4;	
	IO=2F8; IRQ=3;	
Select an optimal setting for IO device		
Mode:	RS232	Optimal Default, Failsafe Default
	RS422	
	RS485	



### 3.4.7.2 SIO Configuration: Serial Port 2 Configuration

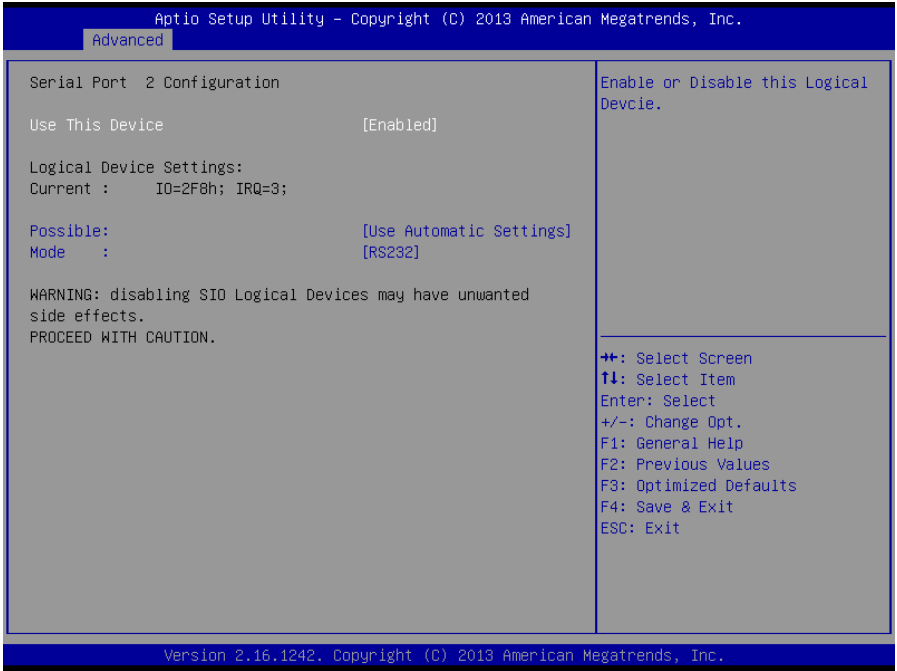

Options summary:

Use This Device	Disabled	Optimal Default, Failsafe Default
	Enabled	
En/Disable Serial Port (COM)		
Possible:	Use Automatic Settings	Optimal Default, Failsafe Default
	IO=2F8; IRQ=3;	
	IO=3F8; IRQ=4;	
Select an optimal setting for IO device		
Mode:	RS232	Optimal Default, Failsafe Default
	RS422	
	RS485	

### 3.5 Setup submenu: Chipset

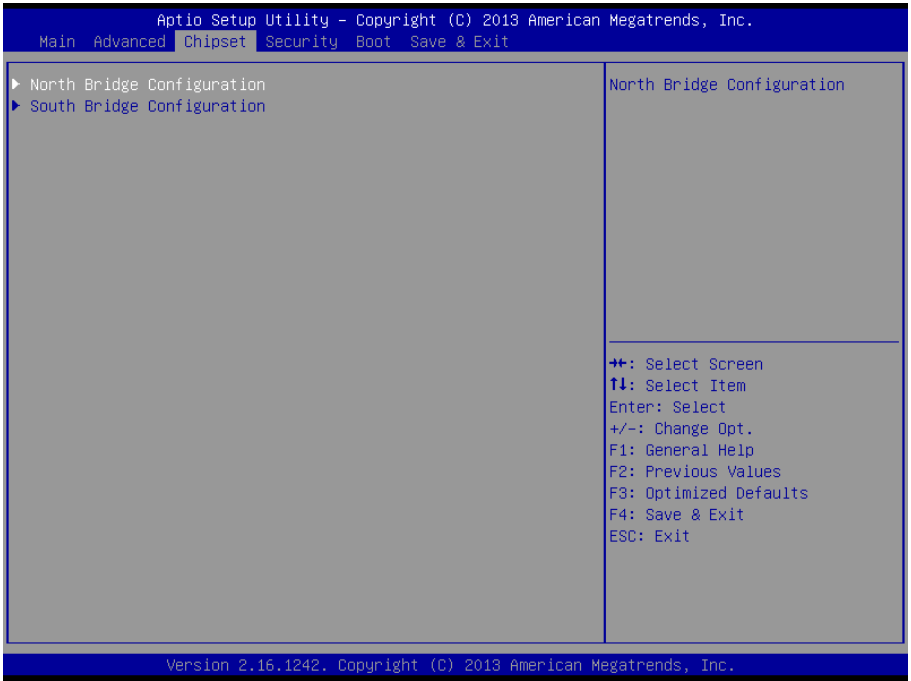

### 3.5.1 Chipset: North Bridge

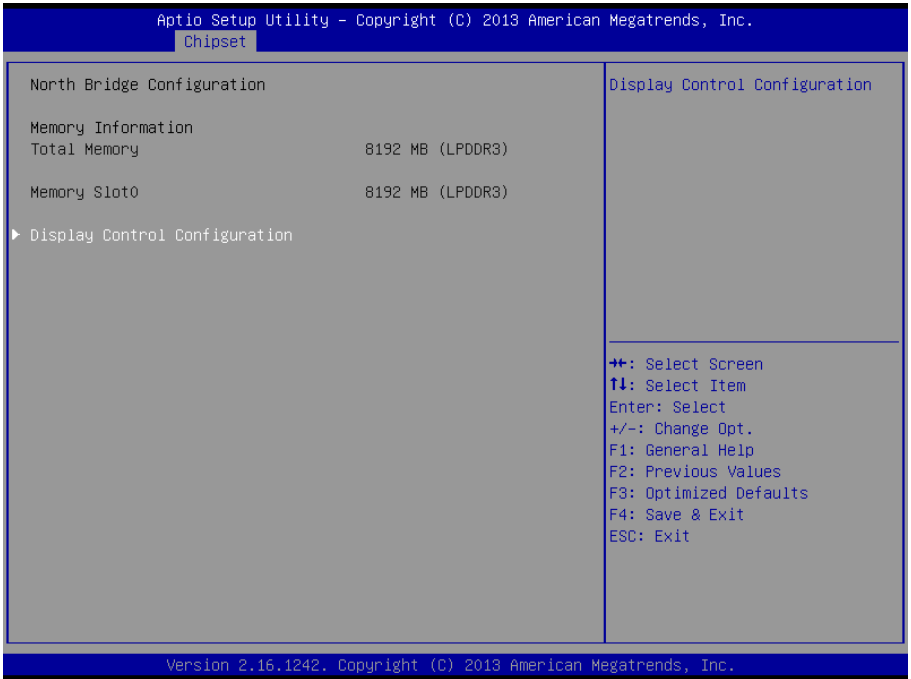

### 3.5.1.1 Display Control Configuration

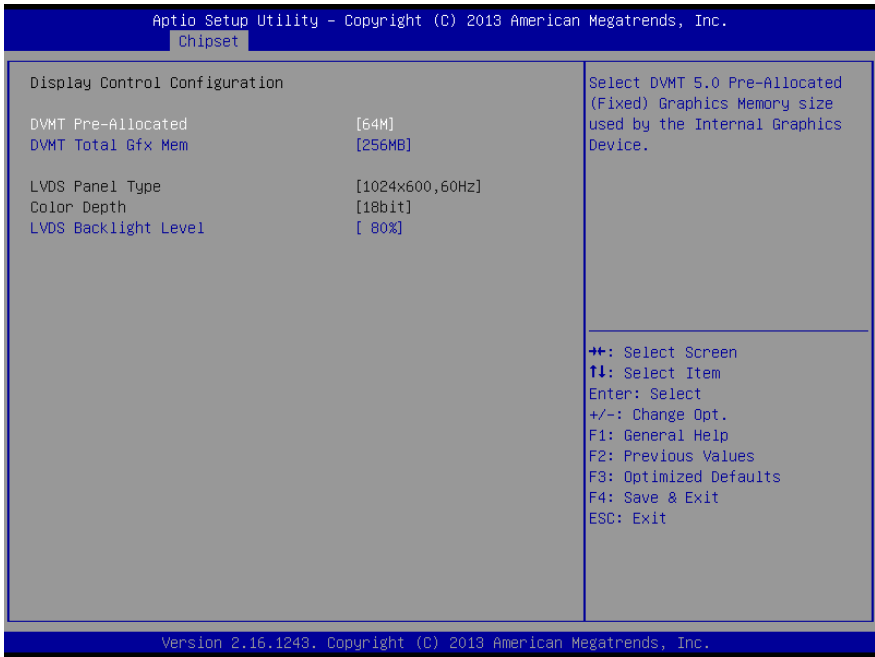

Options summary:

#### Options summary:

DVMT Pre-Allocated	64M	Optimal Default, Failsafe Default
	96M	
	128M	
	160M	
	192M	
	224M	
	256M	
	288M	
	320M	
	352M	
	384M	
	416M	
448M		
480M		

	512M	
DVMT Total Gfx Mem	128MB	Optimal Default, Failsafe Default
	256MB	
	Max	
LVDS Panel Type	1024x600, 60Hz	Optimal Default, Failsafe Default
Color Depth	18 bit	Optimal Default, Failsafe Default
LVDS Backlight Level	100%	Optimal Default, Failsafe Default
	90%	
	80%	
	70%	
	60%	
	50%	
	40%	
	30%	
	20%	
10%		

## 3.5.2 South Bridge

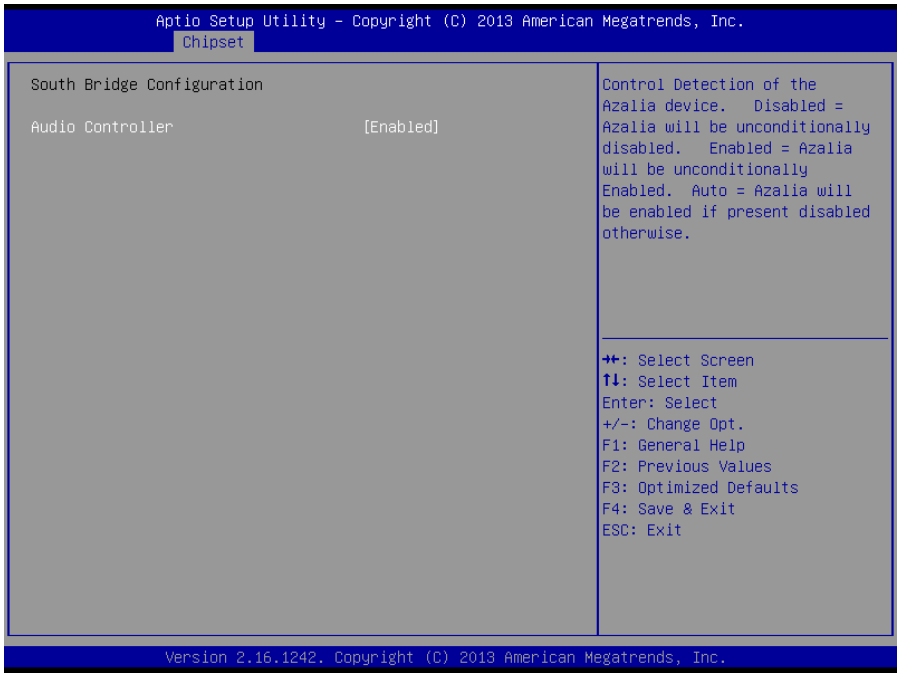

Options summary:

Audio Controller	Disabled	Optimal Default, Failsafe Default
	Enabled	

## 3.6 Security

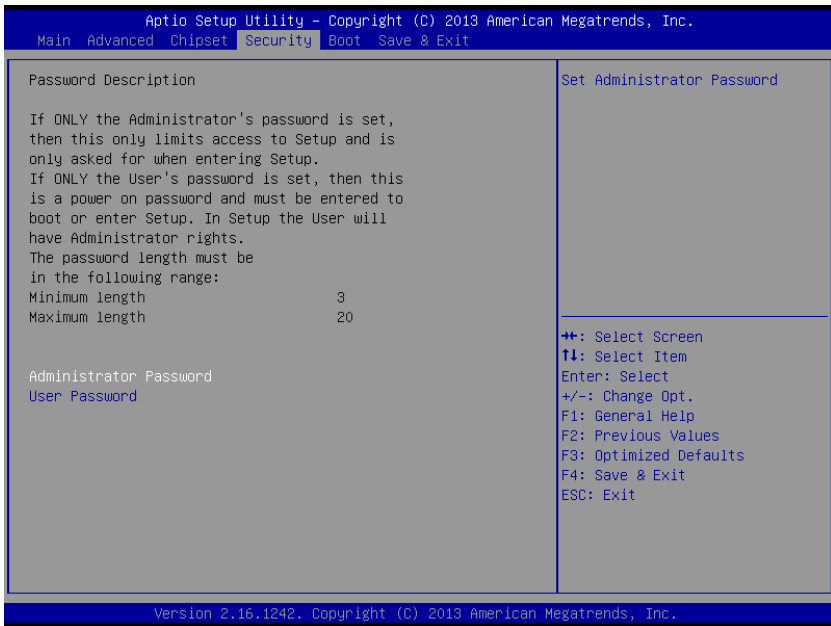

### Change User/Administrator Password

You can set a User Password once an Administrator Password is set. The password will be required during boot up, or when the user enters the Setup utility. Please Note that a User Password does not provide access to many of the features in the Setup utility.

Select the password you wish to set, press Enter to open a dialog box to enter your password (you can enter no more than six letters or numbers). Press Enter to confirm your entry, after which you will be prompted to retype your password for a final confirmation. Press Enter again after you have retyped it correctly.

### Removing the Password

Highlight this item and type in the current password. At the next dialog box press Enter to disable password protection.

### 3.7 Setup submenu: Boot

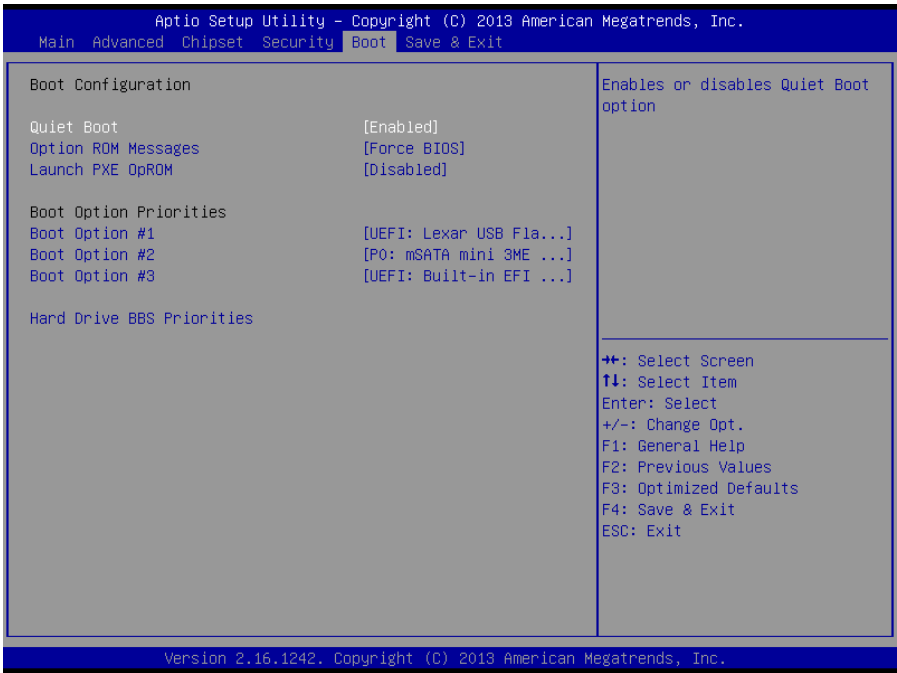

Options summary:

Quiet Boot	Disabled	Default
	Enabled	
En/Disable showing boot logo.		
Option ROM Messages	Force BIOS	Default
	Keep Current	
Set display mode for Option ROM		
Launch PXE OpROM	Disabled	Default
	Enabled	
En/Disable Legacy Boot Option		



### 3.7.1 BBS Priorities



### 3.8 Setup submenu: Exit

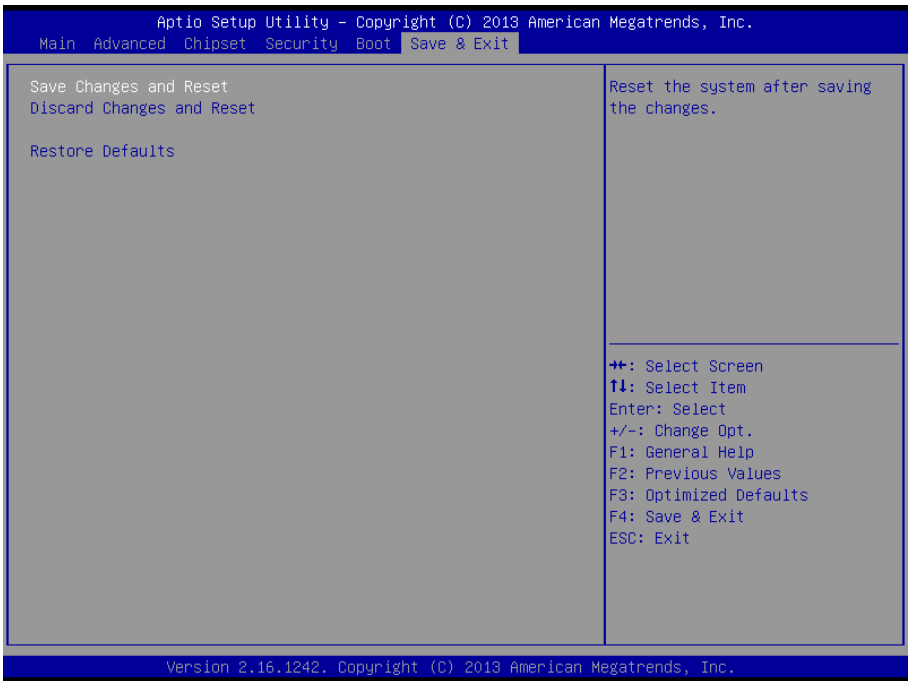

# Chapter 4

---

Drivers Installation

## 4.1 Product CD/DVD

---

The ACP-1074 comes with a product DVD that contains all the drivers and utilities you need to setup your product. Insert the DVD and follow the steps in the autorun program to install the drivers.

In case the program does not start, follow the sequence below to install the drivers.

### Step 1 – Install Chipset Drivers

1. Open the **Step 1 - Chipset** folder followed by the **SetupChipset.exe** file
2. Follow the instructions
3. Drivers will be installed automatically

### Step 2 – Install Graphics Driver

1. Open the **Step 2 - Graphics** folder and select your OS
2. Open the **Setup.exe** file in the folder
3. Follow the instructions
4. Drivers will be installed automatically

### Step 3 – Install Network Driver

1. Open the **Step 3 - Network** folder and select your OS
2. Open the **.exe** file in the folder
3. Follow the instructions
4. Drivers will be installed automatically

#### Step 4 – Install xHCI Driver (Windows 7 only)

1. Open the **Step 4 - xHCI** folder and followed by the **Setup.exe** file
2. Follow the instructions
3. Drivers will be installed automatically

#### Step 5 – Install Intel Sideband Fabric Device Drivers (Windows 8.1/10 only)

1. Open the **Step 5 - Intel Sideband Fabric Device** followed by the **Setup.exe** file
2. Follow the instructions
3. Drivers will be installed automatically

#### Step 6 – Install Touch Drivers (Linux only)

# Appendix A

---

## Watchdog Timer Programming

## A.1 Watchdog Timer Initial Program

Table 1 : SuperIO relative register table		
	Default Value	Note
Index	0x2E(Note1)	SIO MB PnP Mode Index Register 0x2E or 0x4E
Data	0x2F(Note2)	SIO MB PnP Mode Data Register 0x2F or 0x4F

Table 2 : Watchdog relative register table					
	LDN	Register	BitNum	Value	Note
Timer Counter	0x07(Note3)	0xF6(Note4)		(Note24)	Time of watchdog timer (0~255) This register is byte access
Counting Unit	0x07(Note5)	0xF5(Note6)	3(Note7)	0(Note8)	Select time unit. 0: second 1: minute
Watchdog Enable	0x07(Note9)	0xF5(Note10)	5(Note11)	1(Note12)	0: Disable 1: Enable
Timeout Status	0x07(Note13)	0xF5(Note14)	6(Note15)	1	1: Clear timeout status
Output Mode	0x07(Note16)	0xF5(Note17)	4(Note18)	1(Note19)	Select WDTRST# output mode 0: level 1: pulse
WDTRST output	0x07(Note20)	0xFA(Note21)	0(Note22)	1(Note23)	Enable/Disable time out output via WDTRST# 0: Disable 1: Enable

```

*****
// SuperIO relative definition (Please reference to Table 1)
#define byte   SIOIndex //This parameter is represented from Note1
#define byte   SIOData //This parameter is represented from Note2
#define void   IOWriteByte(byte IOPort, byte Value);
#define byte   IOReadByte(byte IOPort);
// Watch Dog relative definition (Please reference to Table 2)
#define byte   TimerLDN //This parameter is represented from Note3
#define byte   TimerReg //This parameter is represented from Note4
#define byte   TimerVal // This parameter is represented from Note24
#define byte   UnitLDN //This parameter is represented from Note5
#define byte   UnitReg //This parameter is represented from Note6
#define byte   UnitBit //This parameter is represented from Note7
#define byte   UnitVal //This parameter is represented from Note8
#define byte   EnableLDN //This parameter is represented from Note9
#define byte   EnableReg //This parameter is represented from Note10
#define byte   EnableBit //This parameter is represented from Note11
#define byte   EnableVal //This parameter is represented from Note12
#define byte   StatusLDN // This parameter is represented from Note13
#define byte   StatusReg // This parameter is represented from Note14
#define byte   StatusBit // This parameter is represented from Note15
#define byte   ModeLDN // This parameter is represented from Note16
#define byte   ModeReg // This parameter is represented from Note17
#define byte   ModeBit // This parameter is represented from Note18
#define byte   ModeVal // This parameter is represented from Note19
#define byte   WDTRstLDN // This parameter is represented from Note20
#define byte   WDTRstReg // This parameter is represented from Note21
#define byte   WDTRstBit // This parameter is represented from Note22
#define byte   WDTRstVal // This parameter is represented from Note23
*****

```



```
*****
VOID Main(){
    // Procedure : AaeonWDTConfig
    // (byte)Timer : Time of WDT timer.(0x00~0xFF)
    // (boolean)Unit : Select time unit(0: second, 1: minute).
    AaeonWDTConfig();

    // Procedure : AaeonWDTEnable
    // This procedure will enable the WDT counting.
    AaeonWDTEnable();
}
*****
```

```

*****
// Procedure : AaeonWDTEnable
VOID  AaeonWDTEnable (){
    WDTEnableDisable(EnableLDN, EnableReg, EnableBit, 1);
}

// Procedure : AaeonWDTConfig
VOID  AaeonWDTConfig (){
    // Disable WDT counting
    WDTEnableDisable(EnableLDN, EnableReg, EnableBit, 0);
    // Clear Watchdog Timeout Status
    WDTClearTimeoutStatus();
    // WDT relative parameter setting
    WDTParameterSetting();
}

VOID  WDTEnableDisable(byte LDN, byte Register, byte BitNum, byte Value){
    SIOBitSet(LDN, Register, BitNum, Value);
}

VOID  WDTParameterSetting(){
    // Watchdog Timer counter setting
    SIOByteSet(TimerLDN, TimerReg, TimerVal);
    // WDT counting unit setting
    SIOBitSet(UnitLDN, UnitReg, UnitBit, UnitVal);
    // WDT output mode setting, level / pulse
    SIOBitSet(ModelLDN, ModeReg, ModeBit, ModeVal);
    // Watchdog timeout output via WDTRST#
    SIOBitSet(WDTRstLDN, WDTRstReg, WDTRstBit, WDTRstVal);
}

VOID  WDTClearTimeoutStatus(){
    SIOBitSet(StatusLDN, StatusReg, StatusBit, 1);
}
*****

```

```

*****
VOID  SIOEnterMBPnPMode(){
    IOWriteByte(SIOIndex, 0x87);
    IOWriteByte(SIOIndex, 0x87);
}

VOID  SIOExitMBPnPMode(){
    IOWriteByte(SIOIndex, 0xAA);
}

VOID  SIOSelectLDN(byte LDN){
    IOWriteByte(SIOIndex, 0x07); // SIO LDN Register Offset = 0x07
    IOWriteByte(SIOData, LDN);
}

VOID  SIOBitSet(byte LDN, byte Register, byte BitNum, byte Value){
    Byte TmpValue;

    SIOEnterMBPnPMode();
    SIOSelectLDN(byte LDN);
    IOWriteByte(SIOIndex, Register);
    TmpValue = IOReadByte(SIOData);
    TmpValue &= ~(1 << BitNum);
    TmpValue |= (Value << BitNum);
    IOWriteByte(SIOData, TmpValue);
    SIOExitMBPnPMode();
}

VOID  SIOByteSet(byte LDN, byte Register, byte Value){
    SIOEnterMBPnPMode();
    SIOSelectLDN(LDN);
    IOWriteByte(SIOIndex, Register);
    IOWriteByte(SIOData, Value);
    SIOExitMBPnPMode();
}
*****

```

















































# Appendix B

---

I/O Information

## B.1 I/O Address Map

Input/output (I/O)	
[0000000000000000 - 000000000000006F]	PCI Express Root Complex
[0000000000000020 - 0000000000000021]	Programmable interrupt controller
[0000000000000024 - 0000000000000025]	Programmable interrupt controller
[0000000000000028 - 0000000000000029]	Programmable interrupt controller
[000000000000002C - 000000000000002D]	Programmable interrupt controller
[000000000000002E - 000000000000002F]	Motherboard resources
[0000000000000030 - 0000000000000031]	Programmable interrupt controller
[0000000000000034 - 0000000000000035]	Programmable interrupt controller
[0000000000000038 - 0000000000000039]	Programmable interrupt controller
[000000000000003C - 000000000000003D]	Programmable interrupt controller
[0000000000000040 - 0000000000000043]	System timer
[000000000000004E - 000000000000004F]	Motherboard resources
[0000000000000050 - 0000000000000053]	System timer
[0000000000000061 - 0000000000000061]	Motherboard resources
[0000000000000063 - 0000000000000063]	Motherboard resources
[0000000000000065 - 0000000000000065]	Motherboard resources
[0000000000000067 - 0000000000000067]	Motherboard resources
[0000000000000070 - 0000000000000070]	Motherboard resources
[0000000000000070 - 0000000000000077]	System CMOS/real time clock
[0000000000000078 - 00000000000000CF]	PCI Express Root Complex
[0000000000000080 - 000000000000008F]	Motherboard resources
[0000000000000092 - 0000000000000092]	Motherboard resources
[00000000000000A0 - 00000000000000A1]	Programmable interrupt controller
[00000000000000A4 - 00000000000000A5]	Programmable interrupt controller
[00000000000000A8 - 00000000000000A9]	Programmable interrupt controller
[00000000000000AC - 00000000000000AD]	Programmable interrupt controller
[00000000000000B0 - 00000000000000B1]	Programmable interrupt controller
[00000000000000B2 - 00000000000000B3]	Motherboard resources
[00000000000000B4 - 00000000000000B5]	Programmable interrupt controller
[00000000000000B8 - 00000000000000B9]	Programmable interrupt controller
[00000000000000BC - 00000000000000BD]	Programmable interrupt controller
[00000000000002F8 - 00000000000002FF]	Communications Port (COM2)
[00000000000003B0 - 00000000000003BB]	Intel(R) HD Graphics
[00000000000003C0 - 00000000000003DF]	Intel(R) HD Graphics
[00000000000003F8 - 00000000000003FF]	Communications Port (COM1)
[0000000000000400 - 000000000000047F]	Motherboard resources
[00000000000004D0 - 00000000000004D1]	Programmable interrupt controller
[0000000000000500 - 00000000000005FE]	Motherboard resources
[0000000000000600 - 000000000000061F]	Motherboard resources
[0000000000000680 - 000000000000069F]	Motherboard resources
[0000000000000A00 - 0000000000000A0F]	Motherboard resources
[0000000000000A10 - 0000000000000A1F]	Motherboard resources
[0000000000000A20 - 0000000000000A2F]	Motherboard resources
[0000000000000D00 - 0000000000000FFF]	PCI Express Root Complex
[000000000000C000 - 000000000000CFFF]	Intel(R) Atom(TM)/Celeron(R)/Pentium(R) Processor PCI Express - Root Port 2 - 0F4A
[000000000000D000 - 000000000000DFFF]	Intel(R) Atom(TM)/Celeron(R)/Pentium(R) Processor PCI Express - Root Port 1 - 0F48
[000000000000E000 - 000000000000E01F]	Intel(R) Atom(TM)/Celeron(R)/Pentium(R) Processor Platform Control Unit - SMBus Port - 0F12
[000000000000E020 - 000000000000E03F]	Standard SATA AHCI Controller
[000000000000E040 - 000000000000E043]	Standard SATA AHCI Controller
[000000000000E050 - 000000000000E057]	Standard SATA AHCI Controller

	[000000000000002E - 00000000000002F] Motherboard resources
	[0000000000000030 - 0000000000000031] Programmable interrupt controller
	[0000000000000034 - 0000000000000035] Programmable interrupt controller
	[0000000000000038 - 0000000000000039] Programmable interrupt controller
	[000000000000003C - 000000000000003D] Programmable interrupt controller
	[0000000000000040 - 0000000000000043] System timer
	[000000000000004E - 000000000000004F] Motherboard resources
	[0000000000000050 - 0000000000000053] System timer
	[0000000000000061 - 0000000000000061] Motherboard resources
	[0000000000000063 - 0000000000000063] Motherboard resources
	[0000000000000065 - 0000000000000065] Motherboard resources
	[0000000000000067 - 0000000000000067] Motherboard resources
	[0000000000000070 - 0000000000000070] Motherboard resources
	[0000000000000070 - 0000000000000077] System CMOS/real time clock
	[0000000000000078 - 00000000000000CF7] PCI Express Root Complex
	[0000000000000080 - 000000000000008F] Motherboard resources
	[0000000000000092 - 0000000000000092] Motherboard resources
	[00000000000000A0 - 00000000000000A1] Programmable interrupt controller
	[00000000000000A4 - 00000000000000A5] Programmable interrupt controller
	[00000000000000A8 - 00000000000000A9] Programmable interrupt controller
	[00000000000000AC - 00000000000000AD] Programmable interrupt controller
	[00000000000000B0 - 00000000000000B1] Programmable interrupt controller
	[00000000000000B2 - 00000000000000B3] Motherboard resources
	[00000000000000B4 - 00000000000000B5] Programmable interrupt controller
	[00000000000000B8 - 00000000000000B9] Programmable interrupt controller
	[00000000000000BC - 00000000000000BD] Programmable interrupt controller
	[00000000000002F8 - 00000000000002FF] Communications Port (COM2)
	[00000000000003B0 - 00000000000003BB] Intel(R) HD Graphics
	[00000000000003C0 - 00000000000003DF] Intel(R) HD Graphics
	[00000000000003F8 - 00000000000003FF] Communications Port (COM1)
	[0000000000000400 - 000000000000047F] Motherboard resources
	[00000000000004D0 - 00000000000004D1] Programmable interrupt controller
	[0000000000000500 - 00000000000005FE] Motherboard resources
	[0000000000000600 - 000000000000061F] Motherboard resources
	[0000000000000680 - 000000000000069F] Motherboard resources
	[0000000000000A00 - 0000000000000A0F] Motherboard resources
	[0000000000000A10 - 0000000000000A1F] Motherboard resources
	[0000000000000A20 - 0000000000000A2F] Motherboard resources
	[0000000000000D00 - 0000000000000FFF] PCI Express Root Complex
	[000000000000C000 - 000000000000CFFF] Intel(R) Atom(TM)/Celeron(R)/Pentium(R) Processor PCI Express - Root Port 2 - 0F4A
	[000000000000D000 - 000000000000DFFF] Intel(R) Atom(TM)/Celeron(R)/Pentium(R) Processor PCI Express - Root Port 1 - 0F48
	[000000000000E000 - 000000000000E01F] Intel(R) Atom(TM)/Celeron(R)/Pentium(R) Processor Platform Control Unit - SMBus Port - 0F12
	[000000000000E020 - 000000000000E03F] Standard SATA AHCI Controller
	[000000000000E040 - 000000000000E043] Standard SATA AHCI Controller
	[000000000000E050 - 000000000000E057] Standard SATA AHCI Controller
	[000000000000E060 - 000000000000E063] Standard SATA AHCI Controller
	[000000000000E070 - 000000000000E077] Standard SATA AHCI Controller
	[000000000000E080 - 000000000000E087] Intel(R) HD Graphics

▷  Interrupt request (IRQ)

▷  Memory

## B.2 Memory Address Map

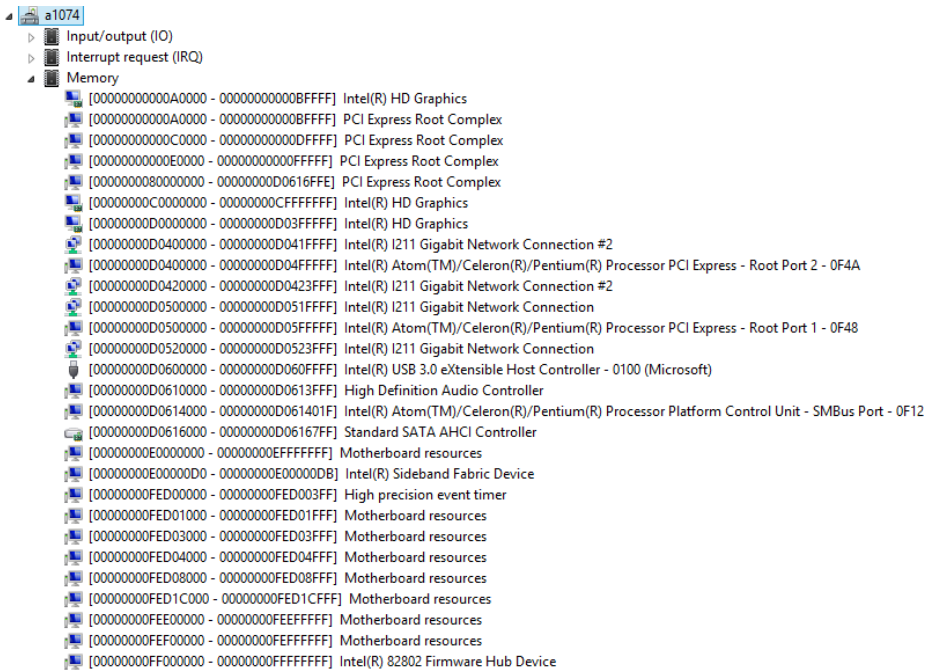



















































The screenshot displays the 'Memory' section of the Windows System Information tool for device 'a1074'. It lists various hardware components and their corresponding memory address ranges. The components include graphics cards, PCI Express Root Complexes, network connections, processors, audio controllers, and motherboard resources.



















































Address Range	Device Name
[0000000000A0000 - 0000000000BFFFFF]	Intel(R) HD Graphics
[0000000000A0000 - 0000000000BFFFFF]	PCI Express Root Complex
[0000000000C0000 - 0000000000DFFFFF]	PCI Express Root Complex
[0000000000E0000 - 0000000000FFFFFF]	PCI Express Root Complex
[0000000080000000 - 00000000D0616FFF]	PCI Express Root Complex
[00000000C0000000 - 00000000CFFFFFFF]	Intel(R) HD Graphics
[00000000D0000000 - 00000000D03FFFFFFF]	Intel(R) HD Graphics
[00000000D0400000 - 00000000D041FFFFF]	Intel(R) I211 Gigabit Network Connection #2
[00000000D0400000 - 00000000D04FFFFFFF]	Intel(R) Atom(TM)/Celeron(R)/Pentium(R) Processor PCI Express - Root Port 2 - 0F4A
[00000000D0420000 - 00000000D0423FFF]	Intel(R) I211 Gigabit Network Connection #2
[00000000D0500000 - 00000000D051FFFFF]	Intel(R) I211 Gigabit Network Connection
[00000000D0500000 - 00000000D05FFFFFFF]	Intel(R) Atom(TM)/Celeron(R)/Pentium(R) Processor PCI Express - Root Port 1 - 0F48
[00000000D0520000 - 00000000D0523FFF]	Intel(R) I211 Gigabit Network Connection
[00000000D0600000 - 00000000D060FFFFFF]	Intel(R) USB 3.0 eXtensible Host Controller - 0100 (Microsoft)
[00000000D0610000 - 00000000D0613FFF]	High Definition Audio Controller
[00000000D0614000 - 00000000D061401F]	Intel(R) Atom(TM)/Celeron(R)/Pentium(R) Processor Platform Control Unit - SMBus Port - 0F12
[00000000D0616000 - 00000000D06167FFF]	Standard SATA AHCI Controller
[00000000E0000000 - 00000000EFFFFFFF]	Motherboard resources
[00000000E00000D0 - 00000000E00000DB]	Intel(R) Sideband Fabric Device
[00000000FED00000 - 00000000FED003FF]	High precision event timer
[00000000FED01000 - 00000000FED01FFF]	Motherboard resources
[00000000FED03000 - 00000000FED03FFF]	Motherboard resources
[00000000FED04000 - 00000000FED04FFF]	Motherboard resources
[00000000FED08000 - 00000000FED08FFF]	Motherboard resources
[00000000FED1C000 - 00000000FED1CFFF]	Motherboard resources
[00000000FEE00000 - 00000000FEEFFFFFFF]	Motherboard resources
[00000000FEF00000 - 00000000FEFFFFFFF]	Motherboard resources
[00000000FF000000 - 00000000FFFFFFFF]	Intel(R) 82802 Firmware Hub Device



















































## B.3 IRQ Mapping Chart



















































Interrupt request (IRQ)	
(ISA) 0x00000000 (00)	System timer
(ISA) 0x00000003 (03)	Communications Port (COM2)
(ISA) 0x00000004 (04)	Communications Port (COM1)
(ISA) 0x00000008 (08)	High precision event timer
(ISA) 0x00000051 (81)	Microsoft ACPI-Compliant System
(ISA) 0x00000052 (82)	Microsoft ACPI-Compliant System
(ISA) 0x00000053 (83)	Microsoft ACPI-Compliant System
(ISA) 0x00000054 (84)	Microsoft ACPI-Compliant System
(ISA) 0x00000055 (85)	Microsoft ACPI-Compliant System
(ISA) 0x00000056 (86)	Microsoft ACPI-Compliant System
(ISA) 0x00000057 (87)	Microsoft ACPI-Compliant System
(ISA) 0x00000058 (88)	Microsoft ACPI-Compliant System
(ISA) 0x00000059 (89)	Microsoft ACPI-Compliant System
(ISA) 0x0000005A (90)	Microsoft ACPI-Compliant System
(ISA) 0x0000005B (91)	Microsoft ACPI-Compliant System
(ISA) 0x0000005C (92)	Microsoft ACPI-Compliant System
(ISA) 0x0000005D (93)	Microsoft ACPI-Compliant System
(ISA) 0x0000005E (94)	Microsoft ACPI-Compliant System
(ISA) 0x0000005F (95)	Microsoft ACPI-Compliant System
(ISA) 0x00000060 (96)	Microsoft ACPI-Compliant System
(ISA) 0x00000061 (97)	Microsoft ACPI-Compliant System
(ISA) 0x00000062 (98)	Microsoft ACPI-Compliant System
(ISA) 0x00000063 (99)	Microsoft ACPI-Compliant System
(ISA) 0x00000064 (100)	Microsoft ACPI-Compliant System
(ISA) 0x00000065 (101)	Microsoft ACPI-Compliant System
(ISA) 0x00000066 (102)	Microsoft ACPI-Compliant System
(ISA) 0x00000067 (103)	Microsoft ACPI-Compliant System
(ISA) 0x00000068 (104)	Microsoft ACPI-Compliant System
(ISA) 0x00000069 (105)	Microsoft ACPI-Compliant System
(ISA) 0x0000006A (106)	Microsoft ACPI-Compliant System
(ISA) 0x0000006B (107)	Microsoft ACPI-Compliant System
(ISA) 0x0000006C (108)	Microsoft ACPI-Compliant System
(ISA) 0x0000006D (109)	Microsoft ACPI-Compliant System
(ISA) 0x0000006E (110)	Microsoft ACPI-Compliant System
(ISA) 0x0000006F (111)	Microsoft ACPI-Compliant System
(ISA) 0x00000070 (112)	Microsoft ACPI-Compliant System
(ISA) 0x00000071 (113)	Microsoft ACPI-Compliant System
(ISA) 0x00000072 (114)	Microsoft ACPI-Compliant System
(ISA) 0x00000073 (115)	Microsoft ACPI-Compliant System
(ISA) 0x00000074 (116)	Microsoft ACPI-Compliant System
(ISA) 0x00000075 (117)	Microsoft ACPI-Compliant System
(ISA) 0x00000076 (118)	Microsoft ACPI-Compliant System
(ISA) 0x00000077 (119)	Microsoft ACPI-Compliant System
(ISA) 0x00000078 (120)	Microsoft ACPI-Compliant System
(ISA) 0x00000079 (121)	Microsoft ACPI-Compliant System
(ISA) 0x0000007A (122)	Microsoft ACPI-Compliant System
(ISA) 0x0000007B (123)	Microsoft ACPI-Compliant System
(ISA) 0x0000007C (124)	Microsoft ACPI-Compliant System
(ISA) 0x0000007D (125)	Microsoft ACPI-Compliant System
(ISA) 0x0000007E (126)	Microsoft ACPI-Compliant System





































































































 (ISA) 0x0000007F (127)	Microsoft ACPI-Compliant System
 (ISA) 0x00000080 (128)	Microsoft ACPI-Compliant System
 (ISA) 0x00000081 (129)	Microsoft ACPI-Compliant System
 (ISA) 0x00000082 (130)	Microsoft ACPI-Compliant System
 (ISA) 0x00000083 (131)	Microsoft ACPI-Compliant System
 (ISA) 0x00000084 (132)	Microsoft ACPI-Compliant System
 (ISA) 0x00000085 (133)	Microsoft ACPI-Compliant System
 (ISA) 0x00000086 (134)	Microsoft ACPI-Compliant System
 (ISA) 0x00000087 (135)	Microsoft ACPI-Compliant System
 (ISA) 0x00000088 (136)	Microsoft ACPI-Compliant System
 (ISA) 0x00000089 (137)	Microsoft ACPI-Compliant System
 (ISA) 0x0000008A (138)	Microsoft ACPI-Compliant System
 (ISA) 0x0000008B (139)	Microsoft ACPI-Compliant System
 (ISA) 0x0000008C (140)	Microsoft ACPI-Compliant System
 (ISA) 0x0000008D (141)	Microsoft ACPI-Compliant System
 (ISA) 0x0000008E (142)	Microsoft ACPI-Compliant System
 (ISA) 0x0000008F (143)	Microsoft ACPI-Compliant System
 (ISA) 0x00000090 (144)	Microsoft ACPI-Compliant System
 (ISA) 0x00000091 (145)	Microsoft ACPI-Compliant System
 (ISA) 0x00000092 (146)	Microsoft ACPI-Compliant System
 (ISA) 0x00000093 (147)	Microsoft ACPI-Compliant System
 (ISA) 0x00000094 (148)	Microsoft ACPI-Compliant System
 (ISA) 0x00000095 (149)	Microsoft ACPI-Compliant System
 (ISA) 0x00000096 (150)	Microsoft ACPI-Compliant System
 (ISA) 0x00000097 (151)	Microsoft ACPI-Compliant System
 (ISA) 0x00000098 (152)	Microsoft ACPI-Compliant System
 (ISA) 0x00000099 (153)	Microsoft ACPI-Compliant System
 (ISA) 0x0000009A (154)	Microsoft ACPI-Compliant System
 (ISA) 0x0000009B (155)	Microsoft ACPI-Compliant System
 (ISA) 0x0000009C (156)	Microsoft ACPI-Compliant System
 (ISA) 0x0000009D (157)	Microsoft ACPI-Compliant System
 (ISA) 0x0000009E (158)	Microsoft ACPI-Compliant System
 (ISA) 0x0000009F (159)	Microsoft ACPI-Compliant System
 (ISA) 0x000000A0 (160)	Microsoft ACPI-Compliant System
 (ISA) 0x000000A1 (161)	Microsoft ACPI-Compliant System
 (ISA) 0x000000A2 (162)	Microsoft ACPI-Compliant System
 (ISA) 0x000000A3 (163)	Microsoft ACPI-Compliant System
 (ISA) 0x000000A4 (164)	Microsoft ACPI-Compliant System
 (ISA) 0x000000A5 (165)	Microsoft ACPI-Compliant System
 (ISA) 0x000000A6 (166)	Microsoft ACPI-Compliant System
 (ISA) 0x000000A7 (167)	Microsoft ACPI-Compliant System
 (ISA) 0x000000A8 (168)	Microsoft ACPI-Compliant System
 (ISA) 0x000000A9 (169)	Microsoft ACPI-Compliant System
 (ISA) 0x000000AA (170)	Microsoft ACPI-Compliant System
 (ISA) 0x000000AB (171)	Microsoft ACPI-Compliant System
 (ISA) 0x000000AC (172)	Microsoft ACPI-Compliant System
 (ISA) 0x000000AD (173)	Microsoft ACPI-Compliant System
 (ISA) 0x000000AE (174)	Microsoft ACPI-Compliant System
 (ISA) 0x000000AF (175)	Microsoft ACPI-Compliant System
 (ISA) 0x000000B0 (176)	Microsoft ACPI-Compliant System
 (ISA) 0x000000B1 (177)	Microsoft ACPI-Compliant System

































 (ISA) 0x000000B2 (178)	Microsoft ACPI-Compliant System
 (ISA) 0x000000B3 (179)	Microsoft ACPI-Compliant System
 (ISA) 0x000000B4 (180)	Microsoft ACPI-Compliant System
 (ISA) 0x000000B5 (181)	Microsoft ACPI-Compliant System
 (ISA) 0x000000B6 (182)	Microsoft ACPI-Compliant System
 (ISA) 0x000000B7 (183)	Microsoft ACPI-Compliant System
 (ISA) 0x000000B8 (184)	Microsoft ACPI-Compliant System
 (ISA) 0x000000B9 (185)	Microsoft ACPI-Compliant System
 (ISA) 0x000000BA (186)	Microsoft ACPI-Compliant System
 (ISA) 0x000000BB (187)	Microsoft ACPI-Compliant System
 (ISA) 0x000000BC (188)	Microsoft ACPI-Compliant System
 (ISA) 0x000000BD (189)	Microsoft ACPI-Compliant System
 (ISA) 0x000000BE (190)	Microsoft ACPI-Compliant System
 (ISA) 0x000000BF (191)	Microsoft ACPI-Compliant System
 (ISA) 0x00000100 (256)	Microsoft ACPI-Compliant System
 (ISA) 0x00000101 (257)	Microsoft ACPI-Compliant System
 (ISA) 0x00000102 (258)	Microsoft ACPI-Compliant System
 (ISA) 0x00000103 (259)	Microsoft ACPI-Compliant System
 (ISA) 0x00000104 (260)	Microsoft ACPI-Compliant System
 (ISA) 0x00000105 (261)	Microsoft ACPI-Compliant System
 (ISA) 0x00000106 (262)	Microsoft ACPI-Compliant System
 (ISA) 0x00000107 (263)	Microsoft ACPI-Compliant System
 (ISA) 0x00000108 (264)	Microsoft ACPI-Compliant System
 (ISA) 0x00000109 (265)	Microsoft ACPI-Compliant System
 (ISA) 0x0000010A (266)	Microsoft ACPI-Compliant System
 (ISA) 0x0000010B (267)	Microsoft ACPI-Compliant System
 (ISA) 0x0000010C (268)	Microsoft ACPI-Compliant System
 (ISA) 0x0000010D (269)	Microsoft ACPI-Compliant System
 (ISA) 0x0000010E (270)	Microsoft ACPI-Compliant System
 (ISA) 0x0000010F (271)	Microsoft ACPI-Compliant System
 (ISA) 0x00000110 (272)	Microsoft ACPI-Compliant System
 (ISA) 0x00000111 (273)	Microsoft ACPI-Compliant System
 (ISA) 0x00000112 (274)	Microsoft ACPI-Compliant System
 (ISA) 0x00000113 (275)	Microsoft ACPI-Compliant System
 (ISA) 0x00000114 (276)	Microsoft ACPI-Compliant System
 (ISA) 0x00000115 (277)	Microsoft ACPI-Compliant System
 (ISA) 0x00000116 (278)	Microsoft ACPI-Compliant System
 (ISA) 0x00000117 (279)	Microsoft ACPI-Compliant System
 (ISA) 0x00000118 (280)	Microsoft ACPI-Compliant System
 (ISA) 0x00000119 (281)	Microsoft ACPI-Compliant System
 (ISA) 0x0000011A (282)	Microsoft ACPI-Compliant System
 (ISA) 0x0000011B (283)	Microsoft ACPI-Compliant System
 (ISA) 0x0000011C (284)	Microsoft ACPI-Compliant System
 (ISA) 0x0000011D (285)	Microsoft ACPI-Compliant System
 (ISA) 0x0000011E (286)	Microsoft ACPI-Compliant System
 (ISA) 0x0000011F (287)	Microsoft ACPI-Compliant System
 (ISA) 0x00000120 (288)	Microsoft ACPI-Compliant System
 (ISA) 0x00000121 (289)	Microsoft ACPI-Compliant System
 (ISA) 0x00000122 (290)	Microsoft ACPI-Compliant System
 (ISA) 0x00000123 (291)	Microsoft ACPI-Compliant System
 (ISA) 0x00000124 (292)	Microsoft ACPI-Compliant System

 (ISA) 0x0000125 (293)	Microsoft ACPI-Compliant System
 (ISA) 0x0000126 (294)	Microsoft ACPI-Compliant System
 (ISA) 0x0000127 (295)	Microsoft ACPI-Compliant System
 (ISA) 0x0000128 (296)	Microsoft ACPI-Compliant System
 (ISA) 0x0000129 (297)	Microsoft ACPI-Compliant System
 (ISA) 0x000012A (298)	Microsoft ACPI-Compliant System
 (ISA) 0x000012B (299)	Microsoft ACPI-Compliant System
 (ISA) 0x000012C (300)	Microsoft ACPI-Compliant System
 (ISA) 0x000012D (301)	Microsoft ACPI-Compliant System
 (ISA) 0x000012E (302)	Microsoft ACPI-Compliant System
 (ISA) 0x000012F (303)	Microsoft ACPI-Compliant System
 (ISA) 0x0000130 (304)	Microsoft ACPI-Compliant System
 (ISA) 0x0000131 (305)	Microsoft ACPI-Compliant System
 (ISA) 0x0000132 (306)	Microsoft ACPI-Compliant System
 (ISA) 0x0000133 (307)	Microsoft ACPI-Compliant System
 (ISA) 0x0000134 (308)	Microsoft ACPI-Compliant System
 (ISA) 0x0000135 (309)	Microsoft ACPI-Compliant System
 (ISA) 0x0000136 (310)	Microsoft ACPI-Compliant System
 (ISA) 0x0000137 (311)	Microsoft ACPI-Compliant System
 (ISA) 0x0000138 (312)	Microsoft ACPI-Compliant System
 (ISA) 0x0000139 (313)	Microsoft ACPI-Compliant System
 (ISA) 0x000013A (314)	Microsoft ACPI-Compliant System
 (ISA) 0x000013B (315)	Microsoft ACPI-Compliant System
 (ISA) 0x000013C (316)	Microsoft ACPI-Compliant System
 (ISA) 0x000013D (317)	Microsoft ACPI-Compliant System
 (ISA) 0x000013E (318)	Microsoft ACPI-Compliant System
 (ISA) 0x000013F (319)	Microsoft ACPI-Compliant System
 (ISA) 0x0000140 (320)	Microsoft ACPI-Compliant System
 (ISA) 0x0000141 (321)	Microsoft ACPI-Compliant System
 (ISA) 0x0000142 (322)	Microsoft ACPI-Compliant System
 (ISA) 0x0000143 (323)	Microsoft ACPI-Compliant System
 (ISA) 0x0000144 (324)	Microsoft ACPI-Compliant System
 (ISA) 0x0000145 (325)	Microsoft ACPI-Compliant System
 (ISA) 0x0000146 (326)	Microsoft ACPI-Compliant System
 (ISA) 0x0000147 (327)	Microsoft ACPI-Compliant System
 (ISA) 0x0000148 (328)	Microsoft ACPI-Compliant System
 (ISA) 0x0000149 (329)	Microsoft ACPI-Compliant System
 (ISA) 0x000014A (330)	Microsoft ACPI-Compliant System
 (ISA) 0x000014B (331)	Microsoft ACPI-Compliant System
 (ISA) 0x000014C (332)	Microsoft ACPI-Compliant System
 (ISA) 0x000014D (333)	Microsoft ACPI-Compliant System
 (ISA) 0x000014E (334)	Microsoft ACPI-Compliant System
 (ISA) 0x000014F (335)	Microsoft ACPI-Compliant System
 (ISA) 0x0000150 (336)	Microsoft ACPI-Compliant System
 (ISA) 0x0000151 (337)	Microsoft ACPI-Compliant System
 (ISA) 0x0000152 (338)	Microsoft ACPI-Compliant System
 (ISA) 0x0000153 (339)	Microsoft ACPI-Compliant System
 (ISA) 0x0000154 (340)	Microsoft ACPI-Compliant System
 (ISA) 0x0000155 (341)	Microsoft ACPI-Compliant System
 (ISA) 0x0000156 (342)	Microsoft ACPI-Compliant System
 (ISA) 0x0000157 (343)	Microsoft ACPI-Compliant System

 (ISA) 0x00000158 (344)	Microsoft ACPI-Compliant System
 (ISA) 0x00000159 (345)	Microsoft ACPI-Compliant System
 (ISA) 0x0000015A (346)	Microsoft ACPI-Compliant System
 (ISA) 0x0000015B (347)	Microsoft ACPI-Compliant System
 (ISA) 0x0000015C (348)	Microsoft ACPI-Compliant System
 (ISA) 0x0000015D (349)	Microsoft ACPI-Compliant System
 (ISA) 0x0000015E (350)	Microsoft ACPI-Compliant System
 (ISA) 0x0000015F (351)	Microsoft ACPI-Compliant System
 (ISA) 0x00000160 (352)	Microsoft ACPI-Compliant System
 (ISA) 0x00000161 (353)	Microsoft ACPI-Compliant System
 (ISA) 0x00000162 (354)	Microsoft ACPI-Compliant System
 (ISA) 0x00000163 (355)	Microsoft ACPI-Compliant System
 (ISA) 0x00000164 (356)	Microsoft ACPI-Compliant System
 (ISA) 0x00000165 (357)	Microsoft ACPI-Compliant System
 (ISA) 0x00000166 (358)	Microsoft ACPI-Compliant System
 (ISA) 0x00000167 (359)	Microsoft ACPI-Compliant System
 (ISA) 0x00000168 (360)	Microsoft ACPI-Compliant System
 (ISA) 0x00000169 (361)	Microsoft ACPI-Compliant System
 (ISA) 0x0000016A (362)	Microsoft ACPI-Compliant System
 (ISA) 0x0000016B (363)	Microsoft ACPI-Compliant System
 (ISA) 0x0000016C (364)	Microsoft ACPI-Compliant System
 (ISA) 0x0000016D (365)	Microsoft ACPI-Compliant System
 (ISA) 0x0000016E (366)	Microsoft ACPI-Compliant System
 (ISA) 0x0000016F (367)	Microsoft ACPI-Compliant System
 (ISA) 0x00000170 (368)	Microsoft ACPI-Compliant System
 (ISA) 0x00000171 (369)	Microsoft ACPI-Compliant System
 (ISA) 0x00000172 (370)	Microsoft ACPI-Compliant System
 (ISA) 0x00000173 (371)	Microsoft ACPI-Compliant System
 (ISA) 0x00000174 (372)	Microsoft ACPI-Compliant System
 (ISA) 0x00000175 (373)	Microsoft ACPI-Compliant System
 (ISA) 0x00000176 (374)	Microsoft ACPI-Compliant System
 (ISA) 0x00000177 (375)	Microsoft ACPI-Compliant System
 (ISA) 0x00000178 (376)	Microsoft ACPI-Compliant System
 (ISA) 0x00000179 (377)	Microsoft ACPI-Compliant System
 (ISA) 0x0000017A (378)	Microsoft ACPI-Compliant System
 (ISA) 0x0000017B (379)	Microsoft ACPI-Compliant System
 (ISA) 0x0000017C (380)	Microsoft ACPI-Compliant System
 (ISA) 0x0000017D (381)	Microsoft ACPI-Compliant System
 (ISA) 0x0000017E (382)	Microsoft ACPI-Compliant System
 (ISA) 0x0000017F (383)	Microsoft ACPI-Compliant System
 (ISA) 0x00000180 (384)	Microsoft ACPI-Compliant System
 (ISA) 0x00000181 (385)	Microsoft ACPI-Compliant System
 (ISA) 0x00000182 (386)	Microsoft ACPI-Compliant System
 (ISA) 0x00000183 (387)	Microsoft ACPI-Compliant System
 (ISA) 0x00000184 (388)	Microsoft ACPI-Compliant System
 (ISA) 0x00000185 (389)	Microsoft ACPI-Compliant System
 (ISA) 0x00000186 (390)	Microsoft ACPI-Compliant System
 (ISA) 0x00000187 (391)	Microsoft ACPI-Compliant System
 (ISA) 0x00000188 (392)	Microsoft ACPI-Compliant System
 (ISA) 0x00000189 (393)	Microsoft ACPI-Compliant System
 (ISA) 0x0000018A (394)	Microsoft ACPI-Compliant System

 (ISA) 0x0000018B (395)	Microsoft ACPI-Compliant System
 (ISA) 0x0000018C (396)	Microsoft ACPI-Compliant System
 (ISA) 0x0000018D (397)	Microsoft ACPI-Compliant System
 (ISA) 0x0000018E (398)	Microsoft ACPI-Compliant System
 (ISA) 0x0000018F (399)	Microsoft ACPI-Compliant System
 (ISA) 0x00000190 (400)	Microsoft ACPI-Compliant System
 (ISA) 0x00000191 (401)	Microsoft ACPI-Compliant System
 (ISA) 0x00000192 (402)	Microsoft ACPI-Compliant System
 (ISA) 0x00000193 (403)	Microsoft ACPI-Compliant System
 (ISA) 0x00000194 (404)	Microsoft ACPI-Compliant System
 (ISA) 0x00000195 (405)	Microsoft ACPI-Compliant System
 (ISA) 0x00000196 (406)	Microsoft ACPI-Compliant System
 (ISA) 0x00000197 (407)	Microsoft ACPI-Compliant System
 (ISA) 0x00000198 (408)	Microsoft ACPI-Compliant System
 (ISA) 0x00000199 (409)	Microsoft ACPI-Compliant System
 (ISA) 0x0000019A (410)	Microsoft ACPI-Compliant System
 (ISA) 0x0000019B (411)	Microsoft ACPI-Compliant System
 (ISA) 0x0000019C (412)	Microsoft ACPI-Compliant System
 (ISA) 0x0000019D (413)	Microsoft ACPI-Compliant System
 (ISA) 0x0000019E (414)	Microsoft ACPI-Compliant System
 (ISA) 0x0000019F (415)	Microsoft ACPI-Compliant System
 (ISA) 0x000001A0 (416)	Microsoft ACPI-Compliant System
 (ISA) 0x000001A1 (417)	Microsoft ACPI-Compliant System
 (ISA) 0x000001A2 (418)	Microsoft ACPI-Compliant System
 (ISA) 0x000001A3 (419)	Microsoft ACPI-Compliant System
 (ISA) 0x000001A4 (420)	Microsoft ACPI-Compliant System
 (ISA) 0x000001A5 (421)	Microsoft ACPI-Compliant System
 (ISA) 0x000001A6 (422)	Microsoft ACPI-Compliant System
 (ISA) 0x000001A7 (423)	Microsoft ACPI-Compliant System
 (ISA) 0x000001A8 (424)	Microsoft ACPI-Compliant System
 (ISA) 0x000001A9 (425)	Microsoft ACPI-Compliant System
 (ISA) 0x000001AA (426)	Microsoft ACPI-Compliant System
 (ISA) 0x000001AB (427)	Microsoft ACPI-Compliant System
 (ISA) 0x000001AC (428)	Microsoft ACPI-Compliant System
 (ISA) 0x000001AD (429)	Microsoft ACPI-Compliant System
 (ISA) 0x000001AE (430)	Microsoft ACPI-Compliant System
 (ISA) 0x000001AF (431)	Microsoft ACPI-Compliant System
 (ISA) 0x000001B0 (432)	Microsoft ACPI-Compliant System
 (ISA) 0x000001B1 (433)	Microsoft ACPI-Compliant System
 (ISA) 0x000001B2 (434)	Microsoft ACPI-Compliant System
 (ISA) 0x000001B3 (435)	Microsoft ACPI-Compliant System
 (ISA) 0x000001B4 (436)	Microsoft ACPI-Compliant System
 (ISA) 0x000001B5 (437)	Microsoft ACPI-Compliant System
 (ISA) 0x000001B6 (438)	Microsoft ACPI-Compliant System
 (ISA) 0x000001B7 (439)	Microsoft ACPI-Compliant System
 (ISA) 0x000001B8 (440)	Microsoft ACPI-Compliant System
 (ISA) 0x000001B9 (441)	Microsoft ACPI-Compliant System
 (ISA) 0x000001BA (442)	Microsoft ACPI-Compliant System
 (ISA) 0x000001BB (443)	Microsoft ACPI-Compliant System
 (ISA) 0x000001BC (444)	Microsoft ACPI-Compliant System
 (ISA) 0x000001BD (445)	Microsoft ACPI-Compliant System

 (ISA) 0x00001BE (446)	Microsoft ACPI-Compliant System
 (ISA) 0x00001BF (447)	Microsoft ACPI-Compliant System
 (ISA) 0x00001C0 (448)	Microsoft ACPI-Compliant System
 (ISA) 0x00001C1 (449)	Microsoft ACPI-Compliant System
 (ISA) 0x00001C2 (450)	Microsoft ACPI-Compliant System
 (ISA) 0x00001C3 (451)	Microsoft ACPI-Compliant System
 (ISA) 0x00001C4 (452)	Microsoft ACPI-Compliant System
 (ISA) 0x00001C5 (453)	Microsoft ACPI-Compliant System
 (ISA) 0x00001C6 (454)	Microsoft ACPI-Compliant System
 (ISA) 0x00001C7 (455)	Microsoft ACPI-Compliant System
 (ISA) 0x00001C8 (456)	Microsoft ACPI-Compliant System
 (ISA) 0x00001C9 (457)	Microsoft ACPI-Compliant System
 (ISA) 0x00001CA (458)	Microsoft ACPI-Compliant System
 (ISA) 0x00001CB (459)	Microsoft ACPI-Compliant System
 (ISA) 0x00001CC (460)	Microsoft ACPI-Compliant System
 (ISA) 0x00001CD (461)	Microsoft ACPI-Compliant System
 (ISA) 0x00001CE (462)	Microsoft ACPI-Compliant System
 (ISA) 0x00001CF (463)	Microsoft ACPI-Compliant System
 (ISA) 0x00001D0 (464)	Microsoft ACPI-Compliant System
 (ISA) 0x00001D1 (465)	Microsoft ACPI-Compliant System
 (ISA) 0x00001D2 (466)	Microsoft ACPI-Compliant System
 (ISA) 0x00001D3 (467)	Microsoft ACPI-Compliant System
 (ISA) 0x00001D4 (468)	Microsoft ACPI-Compliant System
 (ISA) 0x00001D5 (469)	Microsoft ACPI-Compliant System
 (ISA) 0x00001D6 (470)	Microsoft ACPI-Compliant System
 (ISA) 0x00001D7 (471)	Microsoft ACPI-Compliant System
 (ISA) 0x00001D8 (472)	Microsoft ACPI-Compliant System
 (ISA) 0x00001D9 (473)	Microsoft ACPI-Compliant System
 (ISA) 0x00001DA (474)	Microsoft ACPI-Compliant System
 (ISA) 0x00001DB (475)	Microsoft ACPI-Compliant System
 (ISA) 0x00001DC (476)	Microsoft ACPI-Compliant System
 (ISA) 0x00001DD (477)	Microsoft ACPI-Compliant System
 (ISA) 0x00001DE (478)	Microsoft ACPI-Compliant System
 (ISA) 0x00001DF (479)	Microsoft ACPI-Compliant System
 (ISA) 0x00001E0 (480)	Microsoft ACPI-Compliant System
 (ISA) 0x00001E1 (481)	Microsoft ACPI-Compliant System
 (ISA) 0x00001E2 (482)	Microsoft ACPI-Compliant System
 (ISA) 0x00001E3 (483)	Microsoft ACPI-Compliant System
 (ISA) 0x00001E4 (484)	Microsoft ACPI-Compliant System
 (ISA) 0x00001E5 (485)	Microsoft ACPI-Compliant System
 (ISA) 0x00001E6 (486)	Microsoft ACPI-Compliant System
 (ISA) 0x00001E7 (487)	Microsoft ACPI-Compliant System
 (ISA) 0x00001E8 (488)	Microsoft ACPI-Compliant System
 (ISA) 0x00001E9 (489)	Microsoft ACPI-Compliant System
 (ISA) 0x00001EA (490)	Microsoft ACPI-Compliant System
 (ISA) 0x00001EB (491)	Microsoft ACPI-Compliant System
 (ISA) 0x00001EC (492)	Microsoft ACPI-Compliant System
(ISA) 0x00001ED (493)	Microsoft ACPI-Compliant System
(ISA) 0x00001EE (494)	Microsoft ACPI-Compliant System
(ISA) 0x00001EF (495)	Microsoft ACPI-Compliant System
(ISA) 0x00001F0 (496)	Microsoft ACPI-Compliant System

 (ISA) 0x000001F1 (497)	Microsoft ACPI-Compliant System
 (ISA) 0x000001F2 (498)	Microsoft ACPI-Compliant System
 (ISA) 0x000001F3 (499)	Microsoft ACPI-Compliant System
 (ISA) 0x000001F4 (500)	Microsoft ACPI-Compliant System
 (ISA) 0x000001F5 (501)	Microsoft ACPI-Compliant System
 (ISA) 0x000001F6 (502)	Microsoft ACPI-Compliant System
 (ISA) 0x000001F7 (503)	Microsoft ACPI-Compliant System
 (ISA) 0x000001F8 (504)	Microsoft ACPI-Compliant System
 (ISA) 0x000001F9 (505)	Microsoft ACPI-Compliant System
 (ISA) 0x000001FA (506)	Microsoft ACPI-Compliant System
 (ISA) 0x000001FB (507)	Microsoft ACPI-Compliant System
 (ISA) 0x000001FC (508)	Microsoft ACPI-Compliant System
 (ISA) 0x000001FD (509)	Microsoft ACPI-Compliant System
 (ISA) 0x000001FE (510)	Microsoft ACPI-Compliant System
 (ISA) 0x000001FF (511)	Microsoft ACPI-Compliant System
 (PCI) 0x00000005 (05)	Intel(R) Atom(TM)/Celeron(R)/Pentium(R) Processor Platform Control Unit - SMBus Port - 0F12
 (PCI) 0x00000010 (16)	Intel(R) Atom(TM)/Celeron(R)/Pentium(R) Processor PCI Express - Root Port 1 - 0F48
 (PCI) 0x00000011 (17)	Intel(R) Atom(TM)/Celeron(R)/Pentium(R) Processor PCI Express - Root Port 2 - 0F4A
 (PCI) 0x00000012 (18)	Intel(R) Atom(TM)/Celeron(R)/Pentium(R) Processor PCI Express - Root Port 3 - 0F4C
 (PCI) 0x00000013 (19)	Intel(R) Atom(TM)/Celeron(R)/Pentium(R) Processor PCI Express - Root Port 4 - 0F4E
 (PCI) 0x00000013 (19)	Standard SATA AHCI Controller
 (PCI) 0x00000016 (22)	High Definition Audio Controller
 (PCI) 0xFFFFFFF5 (-11)	Intel(R) USB 3.0 eXtensible Host Controller - 0100 (Microsoft)
 (PCI) 0xFFFFFFFF6 (-10)	Intel(R) HD Graphics
 (PCI) 0xFFFFFFFF7 (-9)	Intel(R) I211 Gigabit Network Connection
 (PCI) 0xFFFFFFFF8 (-8)	Intel(R) I211 Gigabit Network Connection
 (PCI) 0xFFFFFFFF9 (-7)	Intel(R) I211 Gigabit Network Connection
 (PCI) 0xFFFFFFFFFA (-6)	Intel(R) I211 Gigabit Network Connection
 (PCI) 0xFFFFFFFFFB (-5)	Intel(R) I211 Gigabit Network Connection #2
 (PCI) 0xFFFFFFFFFC (-4)	Intel(R) I211 Gigabit Network Connection #2
 (PCI) 0xFFFFFFFFFD (-3)	Intel(R) I211 Gigabit Network Connection #2
 (PCI) 0xFFFFFFFFFE (-2)	Intel(R) I211 Gigabit Network Connection #2
 Memory	

# Appendix C

---

Digital I/O Ports



## C.1 DI/O Programming

---

ACP-1074 utilizes FINTEK F81866 chipset as its Digital I/O controller. Below are the procedures to complete its configuration and the AAEMON initial watchdog timer program is also attached based on which you can develop customized program to fit your application.

There are three steps to complete the configuration setup:

- (1) Enter MB PnP Mode
- (2) Modify the configuration registers
- (3) Exit MB PnP Mode. Undesired result may occur if MB PnP Mode is not exited normally. (These three steps are the same as programming WDT)

## C.2 Digital I/O Register

Table 1 : SuperIO relative register table		
	Default Value	Note
Index	0x2E(Note1)	SIO MB PnP Mode Index Register 0x2E or 0x4E
Data	0x2F(Note2)	SIO MB PnP Mode Data Register 0x2F or 0x4F

Table 2 : Digital Input relative register table					
	LDN	Register	BitNum	Value	Note
DIO-1 Pin Status	0x06(Note3)	0xA2(Note4)	0(Note5)		GPIO50
DIO-2 Pin Status	0x06(Note6)	0xA2(Note7)	1(Note8)		GPIO51
DIO-3 Pin Status	0x06(Note9)	0xA2(Note10)	2(Note11)		GPIO52
DIO-4 Pin Status	0x06(Note12)	0xA2(Note13)	3(Note14)		GPIO53
DIO-5 Pin Status	0x06(Note15)	0xA2(Note16)	4(Note17)		GPIO54
DIO-5 Pin Status	0x06(Note18)	0xA2(Note19)	5(Note20)		GPIO55

Table 3 : Digital Output relative register table					
	LDN	Register	BitNum	Value	Note
DIO-1 Output Data	0x06(Note21)	0xA1(Note22)	0(Note23)	(Note24)	GPIO50
DIO-2 Output Data	0x06(Note25)	0xA1(Note26)	1(Note27)	(Note28)	GPIO51
DIO-3 Output Data	0x06(Note29)	0xA1(Note30)	2(Note31)	(Note32)	GPIO52
DIO-4 Output Data	0x06(Note33)	0xA1(Note34)	3(Note35)	(Note36)	GPIO53
DIO-5 Output Data	0x06(Note37)	0xA1(Note38)	4(Note39)	(Note40)	GPIO54
DIO-5 Output Data	0x06(Note41)	0xA1(Note42)	4(Note43)	(Note44)	GPIO55

### C.3 Digital I/O Sample Program

---

```
*****
// SuperIO relative definition (Please reference to Table 1)
#define byte SIOIndex //This parameter is represented from Note1
#define byte SIOData //This parameter is represented from Note2
#define void IOWriteByte(byte IOPort, byte Value);
#define byte IOReadByte(byte IOPort);
// Digital Input Status relative definition (Please reference to Table 2)
#define byte DInput1LDN // This parameter is represented from Note3
#define byte DInput1Reg // This parameter is represented from Note4
#define byte DInput1Bit // This parameter is represented from Note5
#define byte DInput2LDN // This parameter is represented from Note6
#define byte DInput2Reg // This parameter is represented from Note7
#define byte DInput2Bit // This parameter is represented from Note8
#define byte DInput3LDN // This parameter is represented from Note9
#define byte DInput3Reg // This parameter is represented from Note10
#define byte DInput3Bit // This parameter is represented from Note11
#define byte DInput4LDN // This parameter is represented from Note12
#define byte DInput4Reg // This parameter is represented from Note13
#define byte DInput4Bit // This parameter is represented from Note14
#define byte DInput5LDN // This parameter is represented from Note15
#define byte DInput5Reg // This parameter is represented from Note16
#define byte DInput5Bit // This parameter is represented from Note17
#define byte DInput6LDN // This parameter is represented from Note18
#define byte DInput6Reg // This parameter is represented from Note19
#define byte DInput6Bit // This parameter is represented from Note20
*****
```

```
*****
// Digital Output control relative definition (Please reference to Table 3)
#define byte DOutput1LDN // This parameter is represented from Note21
#define byte DOutput1Reg // This parameter is represented from Note22
#define byte DOutput1Bit // This parameter is represented from Note23
#define byte DOutput1Val // This parameter is represented from Note24
#define byte DOutput2LDN // This parameter is represented from Note25
#define byte DOutput2Reg // This parameter is represented from Note26
#define byte DOutput2Bit // This parameter is represented from Note27
#define byte DOutput2Val // This parameter is represented from Note28
#define byte DOutput3LDN // This parameter is represented from Note29
#define byte DOutput3Reg // This parameter is represented from Note30
#define byte DOutput3Bit // This parameter is represented from Note31
#define byte DOutput3Val // This parameter is represented from Note32
#define byte DOutput4LDN // This parameter is represented from Note33
#define byte DOutput4Reg // This parameter is represented from Note34
#define byte DOutput4Bit // This parameter is represented from Note35
#define byte DOutput4Val // This parameter is represented from Note36
#define byte DOutput5LDN // This parameter is represented from Note37
#define byte DOutput5Reg // This parameter is represented from Note38
#define byte DOutput5Bit // This parameter is represented from Note39
#define byte DOutput5Val // This parameter is represented from Note40
#define byte DOutput6LDN // This parameter is represented from Note41
#define byte DOutput6Reg // This parameter is represented from Note42
#define byte DOutput6Bit // This parameter is represented from Note43
#define byte DOutput6Val // This parameter is represented from Note44
*****
```

```
*****
VOID Main(){
    Boolean PinStatus ;

    // Procedure : AaeonReadPinStatus
    // Input :
    //     Example, Read Digital I/O Pin 3 status
    // Output :
    //     InputStatus :
    //         0: Digital I/O Pin level is low
    //         1: Digital I/O Pin level is High
    PinStatus = AaeonReadPinStatus(DInput3LDN, DInput3Reg, DInput3Bit);

    // Procedure : AaeonSetOutputLevel
    // Input :
    //     Example, Set Digital I/O Pin 6 level
    AaeonSetOutputLevel(DOutput6LDN, DOutput6Reg, DOutput6Bit,
DOutput6Val);
}
*****
```

```
*****
Boolean  AaeonReadPinStatus(byte LDN, byte Register, byte BitNum){
    Boolean PinStatus ;

    PinStatus = SIOBitRead(LDN, Register, BitNum);
    Return PinStatus ;
}
VOID  AaeonSetOutputLevel(byte LDN, byte Register, byte BitNum, byte Value){
    ConfigToOutputMode(LDN, Register, BitNum);
    SIOBitSet(LDN, Register, BitNum, Value);
}
*****
```

```

*****
VOID  SIOEnterMBPnPMode(){
    IOWriteByte(SIOIndex, 0x87);
    IOWriteByte(SIOIndex, 0x87);
}

VOID  SIOExitMBPnPMode(){
    IOWriteByte(SIOIndex, 0xAA);
}

VOID  SIOSelectLDN(byte LDN){
    IOWriteByte(SIOIndex, 0x07); // SIO LDN Register Offset = 0x07
    IOWriteByte(SIOData, LDN);
}

VOID  SIOBitSet(byte LDN, byte Register, byte BitNum, byte Value){
    Byte TmpValue;

    SIOEnterMBPnPMode();
    SIOSelectLDN(byte LDN);
    IOWriteByte(SIOIndex, Register);
    TmpValue = IOReadByte(SIOData);
    TmpValue &= ~(1 << BitNum);
    TmpValue |= (Value << BitNum);
    IOWriteByte(SIOData, TmpValue);
    SIOExitMBPnPMode();
}

VOID  SIOByteSet(byte LDN, byte Register, byte Value){
    SIOEnterMBPnPMode();
    SIOSelectLDN(LDN);
    IOWriteByte(SIOIndex, Register);
    IOWriteByte(SIOData, Value);
    SIOExitMBPnPMode();
}
*****

```

```

*****
Boolean  SIOBitRead(byte LDN, byte Register, byte BitNum){
    Byte TmpValue;

    SIOEnterMBPnPMode();
    SIOSelectLDN(LDN);
    IOWriteByte(SIOIndex, Register);
    TmpValue = IOReadByte(SIOData);
    TmpValue &= (1 << BitNum);
    SIOExitMBPnPMode();
    If(TmpValue == 0)
        Return 0;
    Return 1;
}
VOID  ConfigToOutputMode(byte LDN, byte Register, byte BitNum){
    Byte TmpValue, OutputEnableReg;

    OutputEnableReg = Register-1;
    SIOEnterMBPnPMode();
    SIOSelectLDN(LDN);
    IOWriteByte(SIOIndex, OutputEnableReg);
    TmpValue = IOReadByte(SIOData);
    TmpValue |= (1 << BitNum);
    IOWriteByte(SIOData, OutputEnableReg);
    SIOExitMBPnPMode();
}
*****

```