

**ACD-110D**

10.1" WXGA Multi-touch Display

On-screen Display Settings

Aluminum Front Bezel

Projected Capacitive Multi-Touch Screen

## Copyright Notice

This document is copyrighted, 2015. All rights are reserved. The original manufacturer reserves the right to make improvements to the products described in this manual at any time without notice.

No part of this manual may be reproduced, copied, translated, or transmitted in any form or by any means without the prior written permission of the original manufacturer. Information provided in this manual is intended to be accurate and reliable. However, the original manufacturer assumes no responsibility for its use, nor for any infringements upon the rights of third parties, which may result from its use.

The material in this document is for product information only and is subject to change without notice. While reasonable efforts have been made in the preparation of this document to assure its accuracy, AAEON, assumes no liabilities resulting from errors or omissions in this document, or from the use of the information contained herein.

AAEON reserves the right to make changes in the product design without notice to its users.

## Acknowledgments

---

- Intel® is registered trademarks of Intel® Corporation.
- IBM, PC/AT, PS/2 are trademarks of International Business Machines Corporation.
- Microsoft® Windows is a registered trademark of Microsoft® Corporation.
- RTL is a trademark of Realtek Semi-Conductor Co., Ltd.
- C&T is a trademark of Chips and Technologies, Inc.
- UMC is a trademark of United Microelectronics Corporation.
- ITE is a trademark of Integrated Technology Express, Inc.
- SiS is a trademark of Silicon Integrated Systems Corp.
- VIA is a trademark of VIA Technology, Inc.

**All other product names or trademarks are properties of their respective owners.**

## Packing List

---

The LCD monitor should be packaged with the following items. Please check that all of them are included and in good condition.

- 1 ACD-110D
- 1 Utility CD-ROM  
Contains User's Manual (in PDF format), Drivers and Utilities
- 1 VGA Cable
- 1 Touchscreen Mini USB Cable
- 1 AC/DC 12V Power Adapter with Lock

If any of these items are missing or damaged, please contact your distributor or sales representative immediately.

## Safety & Warranty

---

Please read the following safety instructions carefully. It is advised that you keep this manual for future references

1. Disconnect this device from any AC supply before cleaning.
2. While cleaning, use a damp cloth instead of liquid or spray detergents.
3. For any pluggable equipment, the power outlet must be installed near the device and easily accessible.
4. Keep this device away from humidity.
5. Place this device on a solid surface during installation. Dropping it or letting it fall could cause damage.
6. The openings on the device's enclosure are for dissipating heat. **DO NOT COVER THE OPENINGS.**
7. Make sure the voltage of the power source is correct before connecting the device to the power outlet.
8. Position the power cord so that people cannot step on it. Do not place anything over the power cord.
9. All cautions and warnings on the device should be noted.
10. If the device is not to be used for a long time, disconnect it from the power supply to avoid damage by transient over-voltage.
11. Never pour any liquid into the openings. This could cause fire or electric shock.
12. **If any of the following situations arises, please the contact our service personnel:**

- i. **Damaged power cord or plug**
  - ii. **Liquid intrusion to the device**
  - iii. **Exposure to moisture**
  - iv. **Device is not working as expected or in a manner as described in this manual**
  - v. **The device is dropped or damaged**
  - vi. **Any obvious signs of damage displayed on the device**
- 13. DO NOT LEAVE THIS DEVICE IN AN UNCONTROLLED ENVIRONMENT WHERE THE STORAGE TEMPERATURE IS BELOW -10° C (14°F) OR ABOVE 60° C (140° F) TO PREVENT DAMAGE.**
14. As most electronic components are sensitive to static electrical charge, be sure to ground yourself to prevent static charge when installing the internal components. Use a grounding wrist strap and contain all electronic components in any static-shielded devices.

## FCC

---

### **Warning!**



This device complies with Part 15 FCC Rules.

Operation is subject to the following two conditions: (1) this device may not cause harmful interference, and (2) this device must accept any interference received including interference that may cause undesired operation.

### *Caution:*

*It may cause the danger of explosion if battery is incorrectly replaced. Replace only with same or equivalent type recommended by the manufacturer.*

**China RoHS Requirements**  
**产品中有毒有害物质或元素名称及含量**

**AAEON Display**

部件名称	有毒有害物质或元素					
	铅 (Pb)	汞 (Hg)	镉 (Cd)	六价铬 (Cr(VI))	多溴联苯 (PBB)	多溴二苯醚 (PBDE)
印刷电路板 及其电子组件	×	○	○	○	○	○
外部信号 连接器及线材	×	○	○	○	○	○
外壳	×	○	○	○	○	○
液晶模块	×	○	○	○	○	○
触控模块	×	○	○	○	○	○
电源	×	○	○	○	○	○
<p><b>O:</b> 表示该有毒有害物质在该部件所有均质材料中的含量均在 <b>SJ/T 11363-2006</b> 标准规定的限量要求以下。</p> <p><b>X:</b> 表示该有毒有害物质至少在该部件的某一均质材料中的含量超出 <b>SJ/T 11363-2006</b> 标准规定的限量要求。</p> <p><b>备注:</b></p> <p>一、此产品所标示之环保使用期限, 系指在一般正常使用状况下。</p> <p>二、上述部件物质触控模块为选购品。</p>						



# Contents

## Chapter 1 General Information

1.1 Introduction.....	1-2
1.2 Features .....	1-3
1.3 General Specification .....	1-4
1.4 Dimensions.....	1-6

## Chapter 2 Hardware Installation

2.1 Before Unpacking.....	2-2
2.2 Connecting to Power Supply.....	2-3
2.3 Connecting to the Computer .....	2-4
2.4 VGA Port Connector.....	2-5
2.5 DVI Port Connector .....	2-6
2.6 Touchscreen Mini USB Connector.....	2-7
2.7 VESA Wall Mount.....	2-8
2.8 Mounting the Display.....	2-10

## Chapter 3 On-screen Display Settings

3.1 On-screen Display (OSD) Board.....	3-2
3.2 OSD Main Menu.....	3-3
3.3 Input Source.....	3-4
3.4 Contrast/ Brightness- Submenu.....	3-5
3.5 Geometry Menu.....	3-6
3.6 Color/ Temperature- Submenu.....	3-7

3.7 RGB Color- Submenu. ....	3-8
3.8 Language- Submenu.....	3-9
3.9 Auto Config- Submenu.....	3-10
3.10 Resolution- Submenu.....	3-11
3.11 Exit Menu- Submenu.....	3-12

## **Chapter 4 Touch Screen Driver Installation**

4.1 Introduction.....	4-2
4.2 Installation .....	4-2

Chapter

1

**General  
Information**

## 1.1 Introduction

---

Thank you for purchasing the ACD-110D Industry Display Panel TFT LCD monitor.

The LCD monitor has been designed to provide the best performance for many applications. Its compact and slim profile is well suited in working locations where space is at a premium.

Complying with the power management regulations of VESA DPMS, the LCD monitor is extremely energy efficient and power saving while displaying sharper, more brilliant, crisper and flicker-free images. Other features include low radiation and near zero electromagnetic fields emissions.

Fully compatible with a PC, the LCD monitor supports DDC1/DDC2B-compliant “Plug & Play” specification, making installation a breeze.

The On-screen Display menu provides user a user-friendly interface to make right adjustment for most optimal display.

## **1.2 Features**

---

- 10.1" WXGA (1280 x 800) TFT LCD Display
- IP65 Aluminum Front Bezel
- P-CAP Touchscreen Support (7H, two-point multi-touch)
- VESA 75, Panel Mount and Stand Support

### 1.3 General Specification

---

- **Type** Color TFT, LED backlight
- **Size** 10.1" TFT LCD
- **Construction** IP65 aluminum front bezel and SGCC chassis
- **Mounting** VESA 75/ Panel Mount/ Stand
- **Input signal** VGA, DVI-D
- **Control** OSD (On Screen Display) on the panel
- **Power Supply** External power adapter
- **Dimension** 10.47" (W) x 7.22"(H) x 1.57"(D)  
(265.9mm x 183.4mm x 40mm)
- **Gross Weight** 4.4 lb (2.6 Kg)
- **Net Weight** 2.64 lb (1.4 Kg)
- **Power Input** 12V DC
- **Brightness** 250 nits
- **Contrast Ratio** 600:1
- **Viewing Angle** 160°(H)/ 160°(V)
- **Resolution** 1280 x 800
- **Color** 262k colors

#### Touchscreen

- **Type** Projected Capacitive
- **Resolution** 2048 x 2048
- **Light** >86%

**Transmission**

- **Controller** USB interface

**Environmental**

- **Operating temperature** 32°F~ 113°F (0°C to 45°C) without airflow  
32°F~ 122°F (0°C to 50°C) with airflow
- **Storage Temperature** 14°F~ 140°F (-10°C to 60°C)

- **Storage Humidity** 5~90% @ 40°C, non-condensing

- **Vibration** 1g rms/5-500Hz/random operation
- **Shock** 15 G peak acceleration (11 msec. duration)
- **EMC** CE/FCC Class A

### 1.4 Dimensions

ACD-110D  
Units:mm

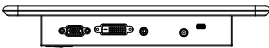
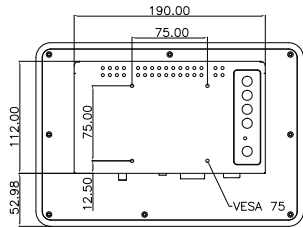
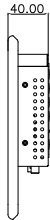
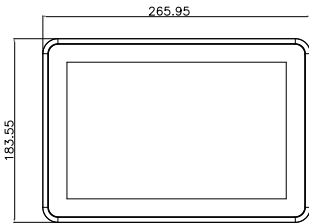
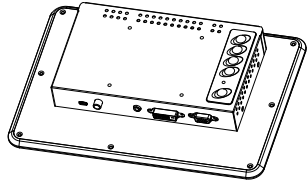
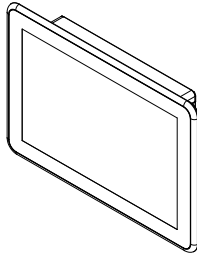



Chapter

2

**Hardware  
Installation**

## 2.1 Before Unpacking

---

It is very important to place the LCD Display in a suitable environment.

- The surface for placing the LCD Display should be stable and leveled.
- Make sure the place has a good airflow and out of direct sunlight; away from excessive dust, dirt, heat, water, moisture or vibrations.

## 2.2 Connecting to Power Supply

---

To power the LCD Display, connect the provided AC-DC adapter and power cord to the power input socket of the monitor. Tighten the connector to secure the connection.



## 2.3 Connecting to the Computer

---

Turn off the computer and the LCD Display before connecting.

- Use the Monitor-to-PC VGA \ DVI-D cable to connect the LCD Display to your computer. The connectors are the same at both ends.
- Tighten the screws on the connector to secure the connection.



## 2.4 VGA Port Connector

---

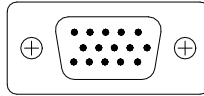

Pin	Signal	Pin	Signal
1	Red	2	Green
3	Blue	4	N.C.
5	GND	6	GND
7	GND	8	GND
9	N.C.	10	GND
11	N.C.	12	SDA
13	HSYNC	14	VSYNC
15	SCL		

## 2.5 DVI Port Connector

*\*DVI cable not included.*

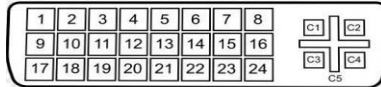

Pin	Signal	Pin	Signal
1	N.C.	2	TMDS Data 2+
3	TMDS Data 2/4 shield	4	TMDS Data 4-
5	TMDS Data 4+	6	DDC clock
7	DDC data	8	N.C.
9	TMDS Data 1-	10	TMDS Data 1
11	TMDS Data 1/3 shield	12	TMDS Data 3-
13	TMDS Data 3+	14	+5V
15	Ground	16	Hot plug detect
17	TMDS data 0-	18	TMDS data 0+
19	TMDS data 0/5 shield	20	TMDS data 5-
21	TMDS data 5+	22	TMDS clock shield
23	TMDS clock+	24	TMDS clock-
C1	N.C.	C2	N.C.
C3	N.C.	C4	N.C.
C5	N.C.		

## 2.6 Touchscreen Mini USB Connector

---

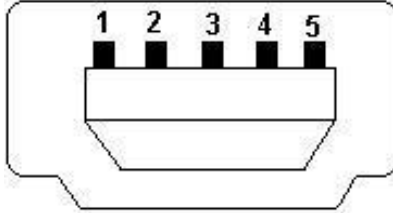

---

Pin	Signal	Pin	Signal
1	+5V	2	DATA (-)
3	DATA (+)	4	N.C.
5	GND, Ground		

---

## 2.7 VESA Wall Mount

---

Mounting the LCD Display with UL Listed wall mount Brackets only. The LCD Display can be mounted on a monitor arm or wall mount plate.

### *Caution:*

*When mounting the LCD Display, make sure to tighten the retention screws or bolts accordingly till they are fully secured. Overtightening may cause them to become stripped, rendering them useless.*

### **Monitor Arm or Wall mount Plate Installation**

The LCD Display has Video Electronics Standards Association (VESA) standard mounting holes tapped into the rear panel. The holes are M4-sized and are set 75mm x 75mm apart.

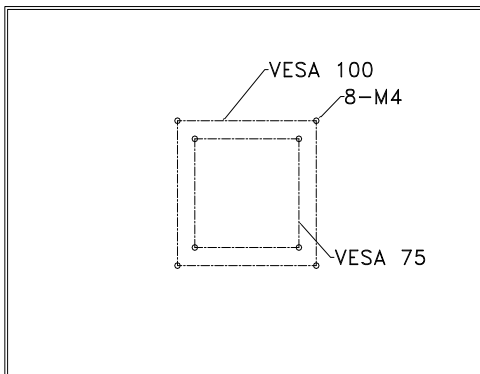



**VESA Mounting Holes**

To mount the LCD Display onto a monitor arm or wall mount plate, please follow the steps below.

Step 1: Line up the threaded holes on the monitor rear panel with the screw holes on the monitor arm or wall mount plate.

Step 2: Secure the monitor to the arm or stand with the retention screws supplied with the monitor arm or stand.

## 2.8 Mounting the Display

---

**Step 1:** Get the wallmount bracket and sponge ready.

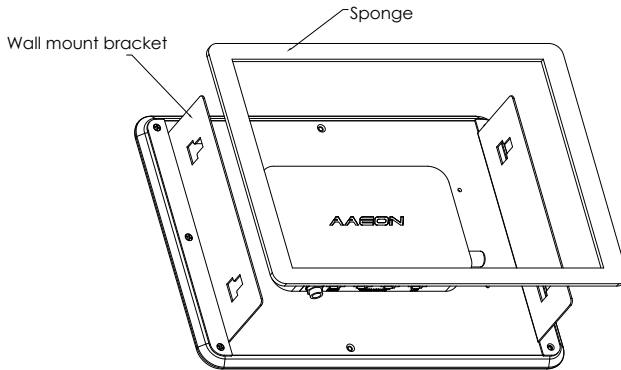

**Step 2:** Remove the six screws (three on each side) at the back and place the wallmount brackets onto the display. Secure the brackets with the original six screws.

**Step 3:** Place the sponge onto the brackets

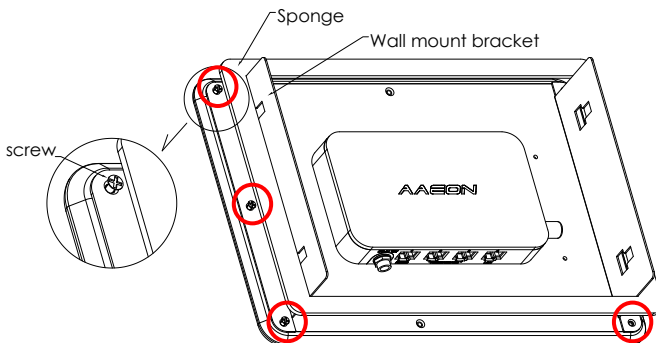

**Step 4:** Insert the display to the surface (opening) where you are going to mount the display

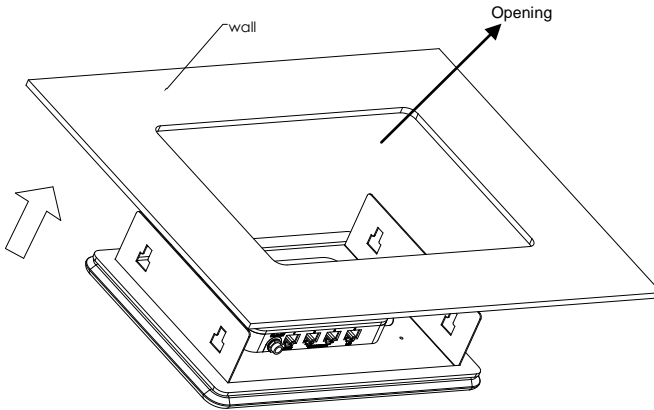

**Step 5:** Attach the mounting clips to the four fillisters on the wallmount brackets and tighten the four M4x60 screws to secure the brackets

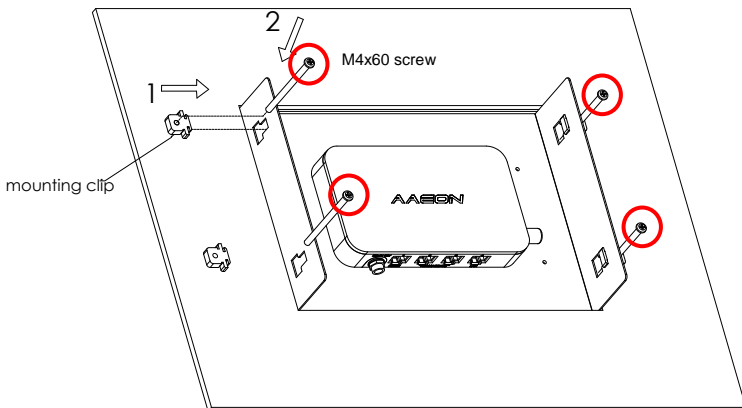

Chapter

3

**On-screen  
Display Settings**



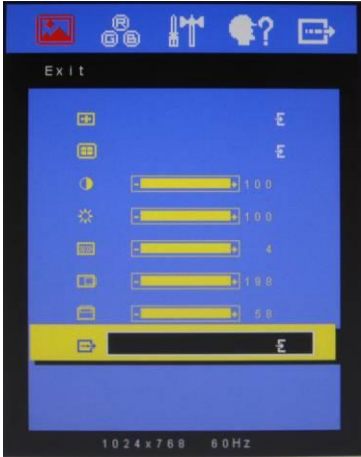

### 3.1 On-screen Display (OSD) Board

Buttons	Function
Auto	<ul style="list-style-type: none"> <li>➤ Automatically adjust the clock, phase, H-position and V-position.</li> <li>➤ Enable fullscreen for the most optimal settings</li> </ul>
Menu / Enter	<ul style="list-style-type: none"> <li>➤ Opens the OSD menu.</li> <li>➤ Enters/confirms the selected options.</li> </ul>
UP / Right / Increase / Input select	<ul style="list-style-type: none"> <li>➤ Move the selector to the next option.</li> <li>➤ Increase the gauge value of the selected option.</li> <li>➤ Change input source.</li> </ul>
Down/ Left / Decrease	<ul style="list-style-type: none"> <li>➤ Move the selector to the previous option.</li> <li>➤ Decrease the gauge value of the selected option.</li> </ul>
Power	<ul style="list-style-type: none"> <li>➤ Turn the monitor ON or OFF.</li> </ul>

### 3.2 OSD Main Menu





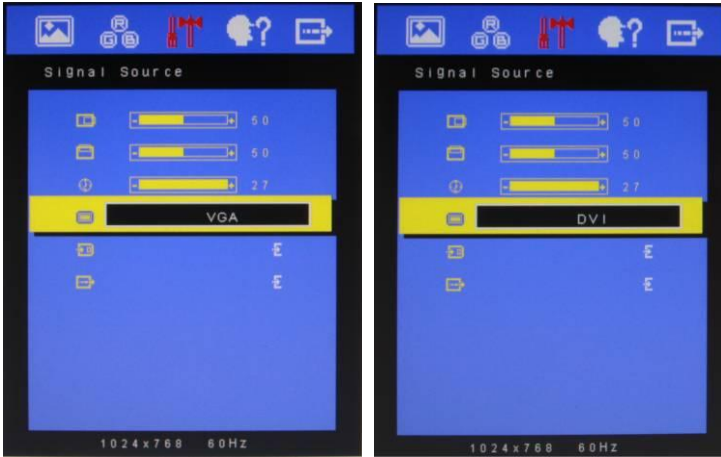

Available Key Functions

	OR	AUTO	Select to confirm
	OR	MENU	Return to last menu
	OR	△	Increase value of selected option
	OR	▽	Decrease value of selected option
			Power On/Off

### 3.3 Input Source





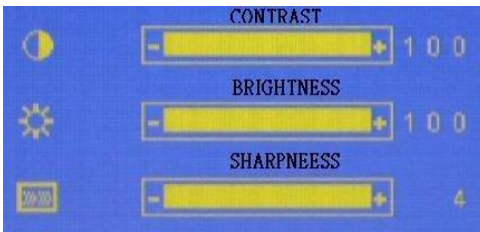

#### Available Key Functions

 OR AUTO	Select to confirm
 OR MENU	Return to last menu
 OR $\Delta$	Increase value of selected option
 OR $\nabla$	Decrease value of selected option
	Power On/Off

### 3.4 Contrast/ Brightness- Submenu



Available Key Functions





 OR <b>AUTO</b>	Select to confirm
 OR <b>MENU</b>	Return to last menu
 OR <b>△</b>	Increase value of selected option
 OR <b>▽</b>	Decrease value of selected option
	Power On/Off

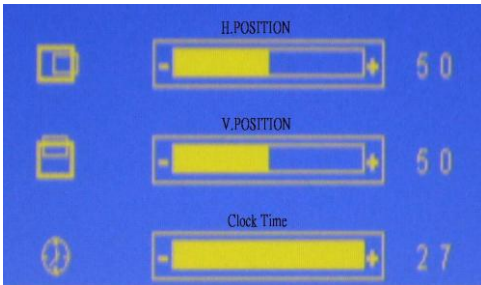

### 3.5 Geometry Menu



#### Available Key Functions

 OR AUTO	Select to confirm
 OR MENU	Return to last menu
 OR $\Delta$	Increase value of selected option
 OR $\nabla$	Decrease value of selected option
	Power On/Off

### 3.6 Color Temperature- Submenu

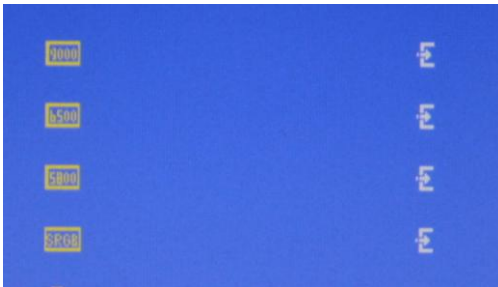
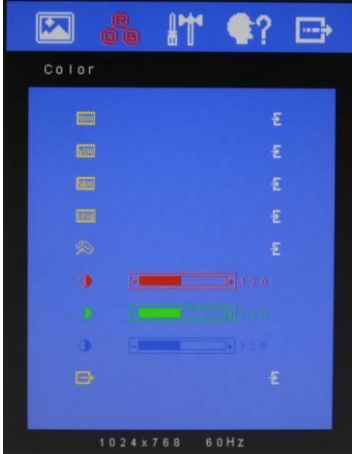

Available Key Functions

	OR	AUTO	Select to confirm
	OR	MENU	Return to last menu
	OR	△	Increase value of selected option
	OR	▽	Decrease value of selected option
			Power On/Off

### 3.7 RGB Color- Submenu

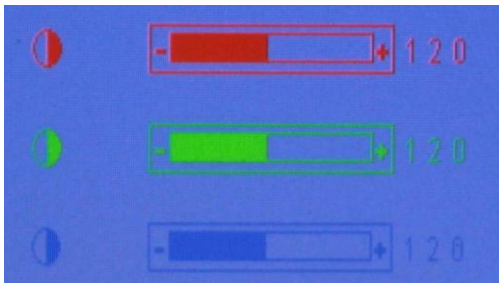







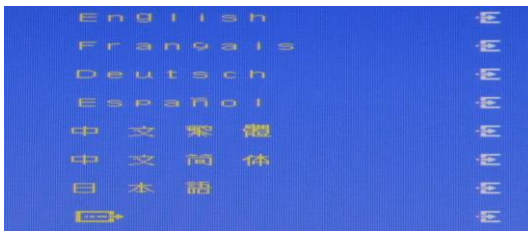

Available Key Functions

	OR	AUTO	Select to confirm
	OR	MENU	Return to last menu
	OR	△	Increase value of selected option
	OR	▽	Decrease value of selected option
			Power On/Off

### 3.8 Language- Submenu







#### Available Key Functions

 OR 	Select to confirm
 OR 	Return to last menu
 or 	Increase value of selected option
 or 	Decrease value of selected option
	Power On/Off

### 3.9 Auto Config- Submenu





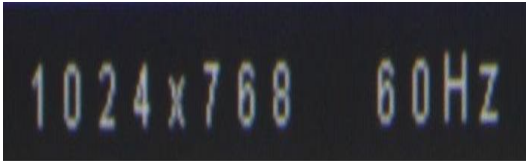

#### Available Key Functions

 OR AUTO	Select to confirm
 OR MENU	Return to last menu
 OR $\Delta$	Increase value of selected option
 OR $\nabla$	Decrease value of selected option
	Power On/Off

### 3.10 Resolution- Submenu



#### Available Key Functions

 OR AUTO	Select to confirm
 OR MENU	Return to last menu
 OR $\Delta$	Increase value of selected option
 OR $\nabla$	Decrease value of selected option
	Power On/Off

### 3.11 Exit Menu- Submenu

---

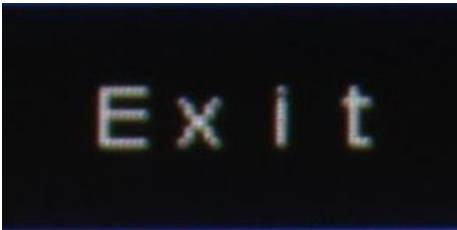

Available Key Functions

	OR	AUTO	Select to confirm
	OR	MENU	Return to last menu
	OR	△	Increase value of selected option
	OR	▽	Decrease value of selected option
			Power On/Off

Chapter

4

# Touchscreen Driver Installation



## 4.1 Introduction

---

The ACD-110D Series touch screen uses Projected Capacitive Multi-Touch technology to provide more accurate sensing capacity than other technologies. The touch screen is specially designed for any infotainment application and has been approved for FCC Class A standards.

## 4.2 Installation

---

Insert the CD-ROM into your disk drive to install the necessary drivers.

Step 1- Install Touch Panel Driver

1. Open the **STEP6-TOUCH** folder followed by the **XP** folder
2. Open **ModifyDBArea.exe**

The system will help you install the driver automatically

**Note 1:** Drivers are not required for Windows® 7 and Linux Ubuntu 14.04

**Note 2:** Only single touch is supported for Windows® XP