

04 UP Xtreme

UP Xtreme developer board with Intel® WHL-U Core™ i7/i5/i3/Celeron® Processor SoC

UP Series

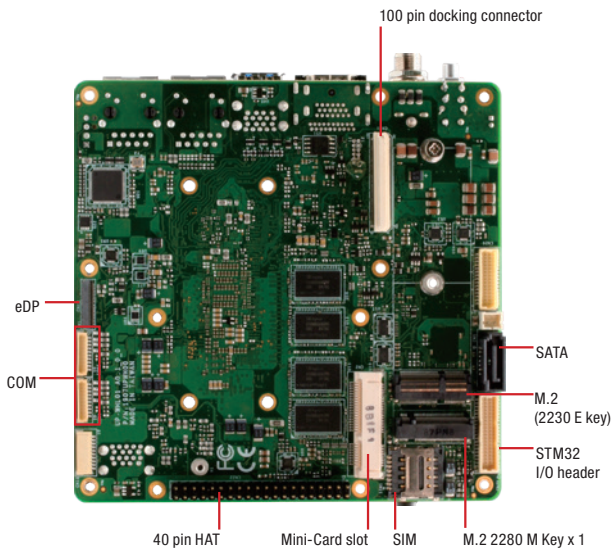
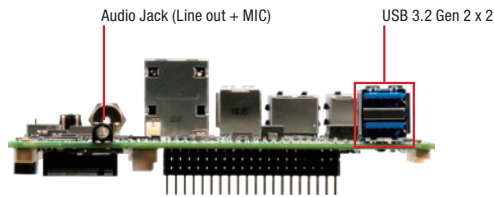
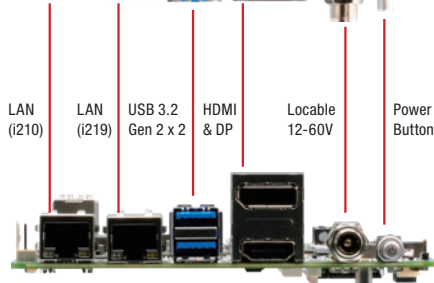
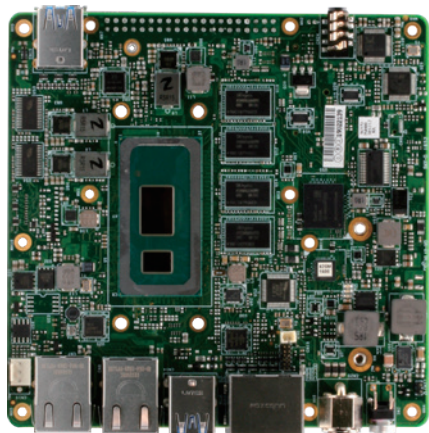

Features

- Intel® WHL-U Core i7/i5/i3/Celeron® Processor SoC
- Onboard DDR4 memory, Max 16GB
- eMMC 64GB
- 40Pin HAT Connector
- 100pin docking connector
- SATA 6.0Gb/s x 3
- Mini-card slot x 1
- M.2 2280 M Key x 1
- M.2 2230 E key x 1
- Audio Jack x 1 (line out + Mic)
- Lockable DC connector

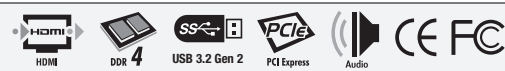

Specifications

System	
Processor	8th generation Intel® Core i7/i5/i3/Celeron® Processor SoC
Graphics	Intel® Graphics , GEN 9
I/O	RJ45 Ethernet Connector x 2 HDMI/DP STACK Connector x 1 Power Button / LED x 1 Audio Jack (Line out + MIC) x 1 DC connector (Lockable) x 1 STM32 connector x 1 eDP with Backlight control Header x 1 10 pin 1xUSB2.0 x 1 / HSUART (TTL) x 1 SATA Connector with power connector (5V, GND) x 1 4 pin Fan connector x1 Power Button header x 1 Reset Pin header x 1 M.2 2230 E Key x 1 M.2 2280 M Key x 1 40 pin HAT connector x 1 mPCIe slot x 1 10 pin RS232/422/485 pin header x 2 100pin connector x 1
Camera	—
USB	USB 3.2 Gen 2 STACK Connector for 2 ports (Front) x 1 USB 3.2 Gen 2 STACK Connector for 2 ports (Rear) x 1
Expansion	M.2 2230 E Key x 1 M.2 2280 M key x 1 mPCIe slot x 1 100pin connector x 1 40pin HAT
RTC	RTC battery, CR2032 x 1
Power	12V - 60VDC
Dimension	122 x 120 mm
Memory	Onboard DDR4 memory, Max 16GB Single Channel: 4GB Dual Channel: 8GB, 16GB
Storage	SATA3 (6Gb/s) x 3: a. SATA connector x 1 b. M.2 2280 SATA option (auto detect) x 1 c. minicard mSATA option (auto detect) x 1
Display Interface	HDMI2.0 x 1 DP1.2 x 1 eDP x 1 CEC support with STM32 on HDMI x 1
Ethernet	i7/i5 SKU LAN (i210 AT) x 1, LAN (i219 LM) x 1 i3/Celeron® LAN (i210 AT) x 1, LAN (i219 V) x 1
OS Support	Win 10 Linux Ubuntu 18.04 with Kernel 5.0 Linux Yocto 2.7 with Kernel 4.19
Operating Temperature	32°F ~ 140°F (0°C ~ 60°C)
Operation Humidity	0% ~ 90% relative humidity, non-condensing
Certification	CE/FCC class A, RoHS Compliant, REACH

Block Diagram

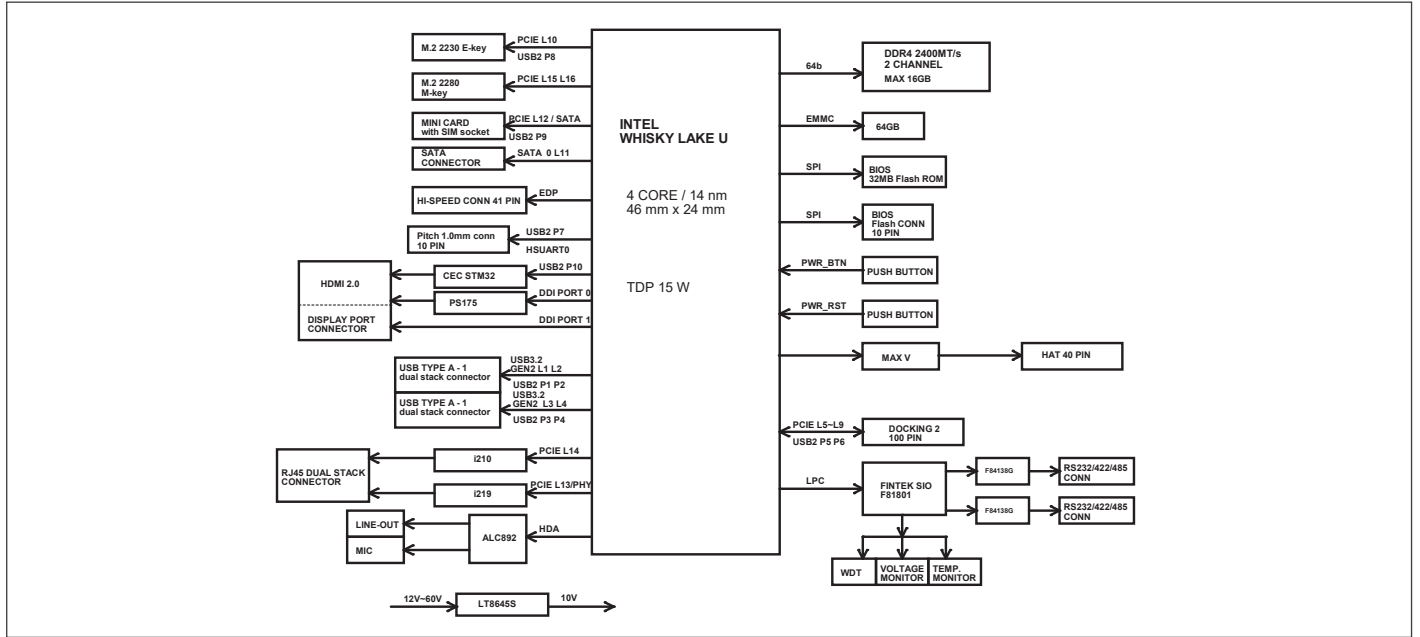

Dimension

Unit: mm

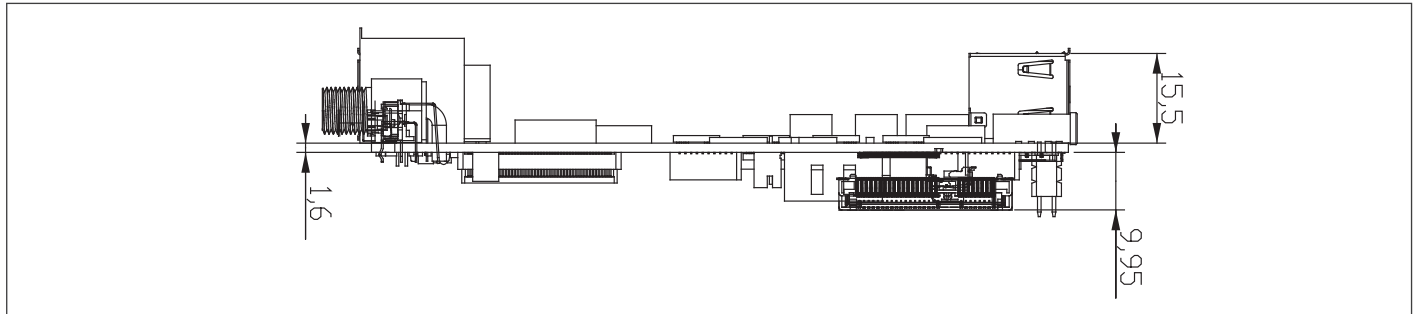

Ordering Information

Part number	CPU	RAM	Storage	LAN	USB	RS-232/422/485	Expansion Slot	Power	Operation Temp.
UPX-WHLI7-A20-16064	Core I7-8665UE	16GB	64GB	GbE x 2	USB 3.2 Gen 2 x 4 USB 2.0 x 1	2	Mini card x 1, M.2 2280 B + M key x 1, M.2 2230 E key x 1	12-60V	32°F ~140°F (0°C ~ 60°C)
UPX-WHLI5-A20-08064	Core I5-8365UE	8GB	64GB	GbE x 2	USB 3.2 Gen 2 x 4 USB 2.0 x 1	2	Mini card x 1, M.2 2280 B + M key x 1, M.2 2230 E key x 1	12-60V	32°F ~140°F (0°C ~ 60°C)
UPX-WHLI3-A20-08064	Core I3-8145UE	8GB	64GB	GbE x 2	USB 3.2 Gen 2 x 4 USB 2.0 x 1	2	Mini card x 1, M.2 2280 B + M key x 1, M.2 2230 E key x 1	12-60V	32°F ~140°F (0°C ~ 60°C)
UPX-WHLICR-A20-04064	Celeron 4305UE	4GB	64GB	GbE x 2	USB 3.2 Gen 2 x 4 USB 2.0 x 1	2	Mini card x 1, M.2 2280 B + M key x 1, M.2 2230 E key x 1	12-60V	32°F ~140°F (0°C ~ 60°C)
UPX-WHLI7C-A20-16064	Core I7-8565U	16GB	64GB	GbE x 2	USB 3.2 Gen 2 x 4 USB 2.0 x 1	2	Mini card x 1, M.2 2280 B + M key x 1, M.2 2230 E key x 1	12-60V	32°F ~140°F (0°C ~ 60°C)

Packing List

- UPX-WHL01 with Heatsink + cooler

Optional Accessories

Part Number	Description
125530065A	19Vdc/3.42A.65W power adapter
1702031830	Power cord for USA
9741364A00	Wireless LAN Kit M.2 2230 802.11ac/a/b/g/n + BT 4.0, 2T2R, with 2 sets of cable & antenna (Enli, QCNFA364A)
9741159H00	(TF) Wireless LAN kit IEEE 802.11.b/g/n.w/BT 4.0/3.0.(AzureWave.AW-NB159H).w/cable.&antenna (mini card)
PER-TAIX2-A10-2280	AI Core XM 2280.M.2 2280 B+M key card.with Dual Myriad X.15 mm heat sink with FAN
UPCP-CR-VPX3-A10-001	Vision Plus X.w/ 3x Myriad X 2485.fan heatsink.REV.A1.0
UPCP-CR-NPL4-A10-002	Net Plus.i210-IT.for UP core Plus.A1.0