

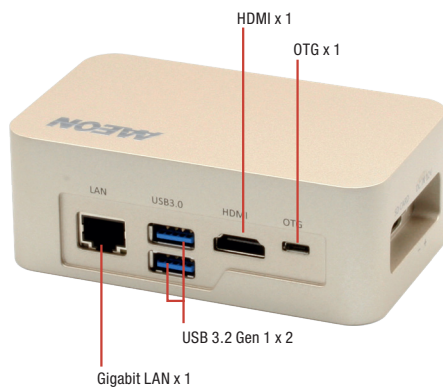

Front View

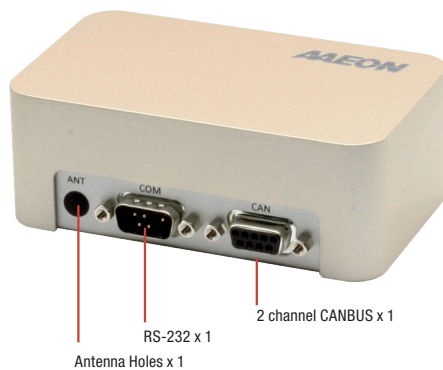

Rear View



Side View

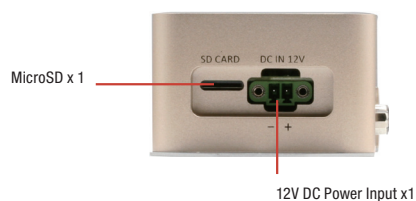

## Features

- NVIDIA Jetson TX2
- Support AAEON ACLinux 4.9, Compliance with Ubuntu 18.04
- 8GB LPDDR4, 32GB eMMC 5.1
- HMP Dual Denver 2 + Quad ARM A57
- HDMI 2.0 x 1, USB 3.2 Gen 1 x 2
- RS-232 x 1, CANBUS x 2 Channel
- OTG x 1
- LAN x 1
- MicroSD x 1



## Specifications

System	
CPU	HMP Dual Denver 2 + Quad ARM A57
Chipset	—
System Memory	8GB LPDDR4
AI Solution	Nvidia Jetson TX2
Display Interface	HDMI 2.0
Storage Device	32GB eMMC 5.1, MicroSD
Ethernet	10/100/1000 Base-TX x 1
I/O	USB 3.2 Gen 1 x 2 HDMI x 1 LAN x 1 MicroSD x 1 OTG x 1 Antenna Hole x 1 DC Power Input x 1 2 channel CANBUS x 1 DB-9 RS-232 x 1
Expansion	—
Indicator	—
OS Support	AAEON ACLinux 4.9, Compliance with Ubuntu 18.04
Power Supply	
Power Requirement	12V with 2-pin terminal block
Mechanical	
Mounting	Wallmount
Dimensions (W x H x D)	4.33" x 1.57" x 2.56" (110mm x 40mm x 65mm)
Gross Weight	2.20 lb (1 kg)
Net Weight	1.10 lb (0.5 kg)
Environmental	
Operating Temperature	-4°F ~ 122°F (-20°C ~ 50°C, according to IEC60068-2 with 0.5 m/s AirFlow; with Industrial Device)
Storage Temperature	-49°F ~ 176°F (-45°C ~ 80°C)
Storage Humidity	95% @ 40°C, non-condensing
Anti-Vibration	3 Grms/ 5 ~ 500Hz/ operation – eMMC
Certification	CE/FCC class A

## Dimension

Unit: mm

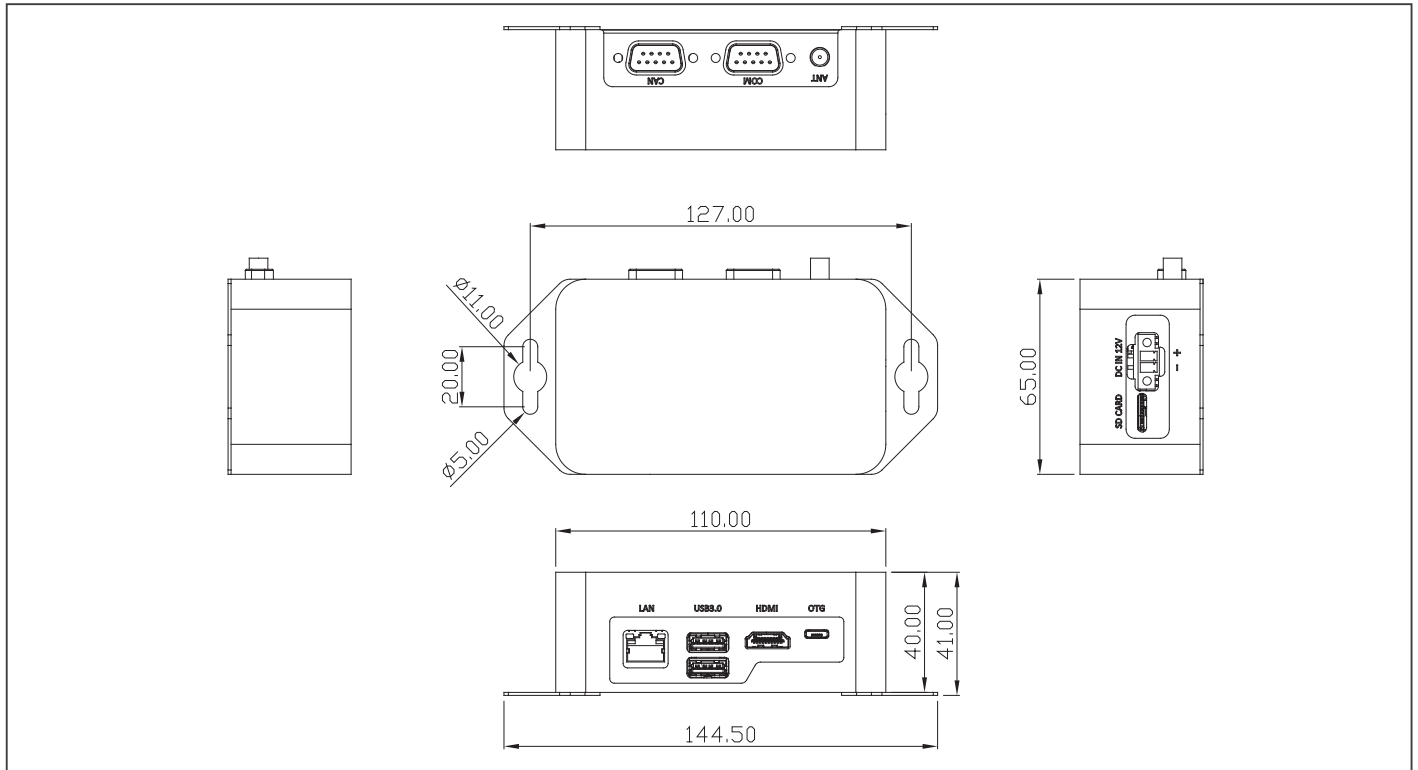

## Ordering Information

Part Number	CPU	PCH	RAM	LAN	USB 3.2 Gen 1	USB 2.0	RS-232	CANBUS	Digital I/O	Audio	Storage	Display	Expansion	Mounting	Power	Operation temp.
BOXER-8110AI-A1-1010	HMP Dual Denver 2 + Quad ARM A57	—	8	1	2	—	1	1	—	—	32G eMMC	HDMI x 1	MicroSD x 1	Wallmount	12V	-20°C ~ 50°C

## Packing List

- Wallmount Bracket x 2
- BOXER-8110AI

## Optional Accessories

- 1255300611  
Power Adapter
- 1702031802  
Power Cord (US Type)
- 1702031803  
Power Cord (Europe)
- 170203180E  
Power Cord (Japan)

# BOXER-8120AI

AI@Edge Fanless Embedded Box PC with NVIDIA Jetson TX2, 4 GbE LAN Ports

BOXER-8120AI-A1-1010  
Front View

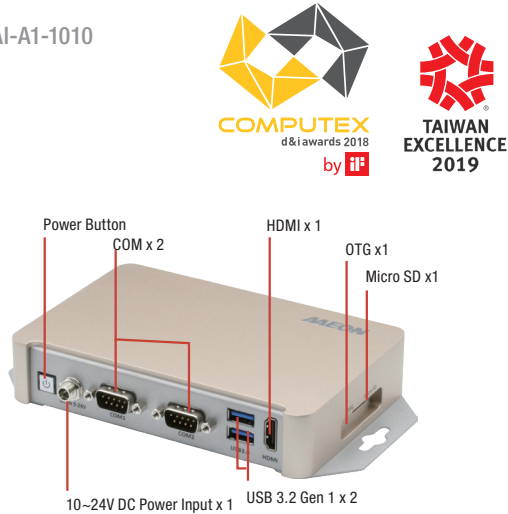

Rear View

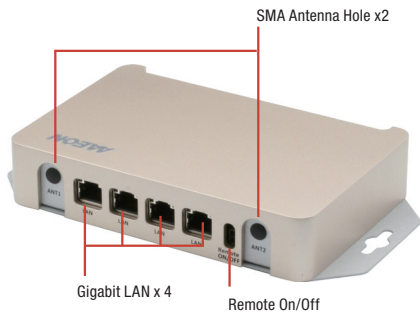

BOXER-8120AI-A1-CS-N0001  
Front View

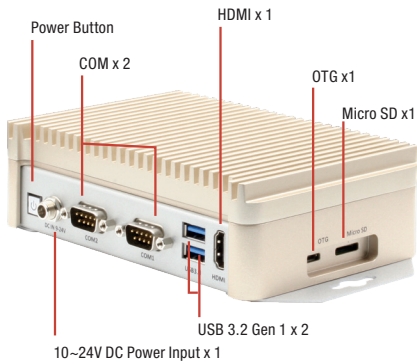

Rear View

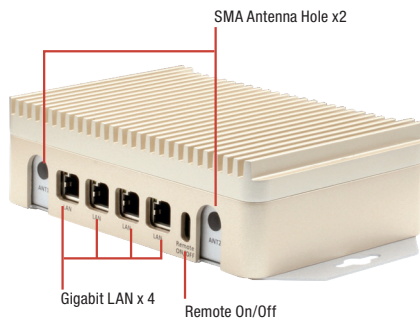

## Features

- Nvidia Jetson TX2
- HMP Dual Denver 2 + Quad ARM A57
- Support AAEON ACLinux 4.9, Compliance with Ubuntu 18.04
- 8GB LPDDR4, 32GB eMMC 5.1
- RS-232 x 2, USB 3.2 Gen 1 x 2, OTG x 1
- HDMI 2.0 x 1, LAN x 4 (Intel i211\*3, Native\*1)
- Micro-SD x 1, Remote On/Off
- Power input: 10~24V



## Specifications

System	
CPU	HMP Dual Denver 2 + Quad ARM A57
Chipset	—
System Memory	8GB LPDDR4
AI Solution	Nvidia Jetson TX2
Display Interface	HDMI 2.0
Storage Device	32GB eMMC 5.1 MicroSD x1
Ethernet	10/100/1000Base-TX x 4
I/O	USB 3.2 Gen 1 x 2 HDMI x 1 LAN x 4 COM x 2 OTG x 1 Power Button x 1 SMA Antenna Holes x 2 10~24V DC-In Power input x 1 Remote Power On/Off x 1
Expansion	MicroSD x1 SATA x1 (optional) USB 2.0 x 3 (optional)
Indicator	Power LED
OS Support	AAEON ACLinux 4.9, Compliance with Ubuntu 18.04
Power Supply	
Power Requirement	10~24V DC-In with DC Jack
Mechanical	
Mounting	Wallmount
Dimensions (W x H x D)	6.02" x 1.18" x 3.98" (153mm x 30mm x 101mm) 6.02" x 1.79" x 3.98" (153mm x 45.5mm x 101mm) for CS-N0001
Gross Weight	4.40 lb (2 Kg) 5.51 lb (2.5 Kg) for CS-N0001
Net Weight	2.20 lb (1 Kg) 3.31 lb (1.5 Kg) for CS-N0001
Environmental	
Operating Temperature	-4°F ~ 122°F (-20°C ~ 50°C, according to IEC682-14 with 0.5 m/s AirFlow; with industrial Devices) for BOXER-8120AI-A1-1010 -4°F ~ 131°F (-20°C ~ 55°C, according to IEC682-14 with 0.5 m/s AirFlow; with industrial Devices) for BOXER-8120AI-A1-CS-N0001
Storage Temperature	-13°F ~ 176°F (-25°C ~ 80°C)
Storage Humidity	95% @ 40°C, non-condensing
Anti-Vibration	Random, 5 Grms/ 5 ~ 500Hz/ operation
Certification	CE/FCC class A

### Dimension

Unit: mm

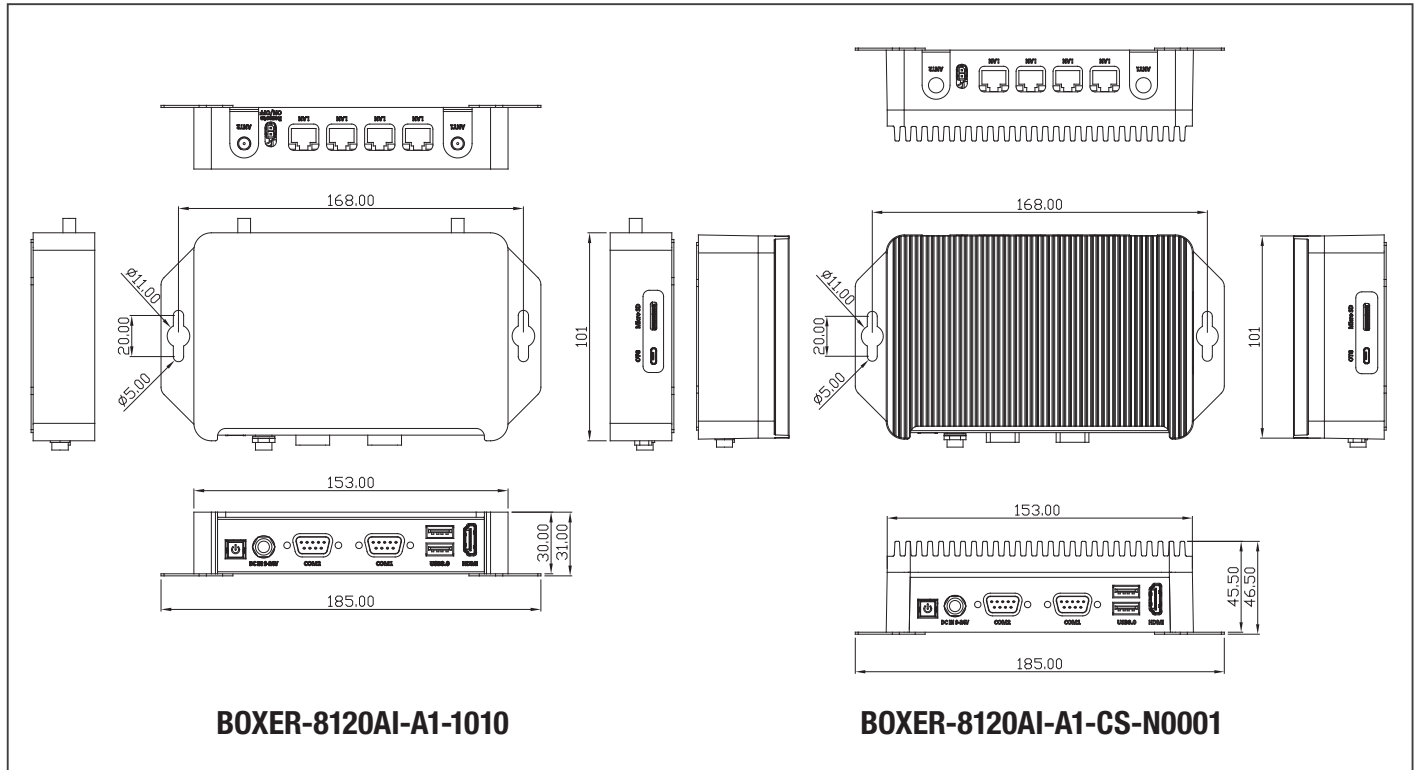

**BOXER-8120AI-A1-1010**

**BOXER-8120AI-A1-CS-N0001**

### Ordering Information

Part Number	CPU	PCH	RAM	LAN	USB 3.2 Gen 1	USB 2.0	RS-232	RS-232/422/485	Digital I/O	Audio	Storage	Display	Expansion	Mounting	Power	Operation temp.
BOXER-8120AI-A1-1010	HMP Dual Denver 2 + Quad ARM A57	—	8	4	2	—	2	—	—	—	32G eMMC	HDMI x 1	MicroSD x1 SATA x1 (option) USB 2.0 x 3 (option)	Wallmount	10 ~ 24V	-20°C ~ 50°C
BOXER-8120AI-A1-CS-N0001	HMP Dual Denver 2 + Quad ARM A57	—	8	4	2	—	2	—	—	—	32G eMMC	HDMI x 1	MicroSD x1 SATA x1 (option) USB 2.0 x 3 (option)	Wallmount	10 ~ 24V	-20°C ~ 50°C

### Packing List

- Wallmount Bracket x 1
- Screw Package x 1
- BOXER-8120AI

### Optional Accessories

- 125530060Z  
Power Adapter
- 1702031802  
Power Cord (US Type)
- 1702031803  
Power Cord (Europe)
- 170203180E  
Power Cord (Japan)

# BOXER-8130AI

AI@Edge Fanless Embedded Box PC with NVIDIA Jetson TX2, MIPI-CSI2 interface

Front View

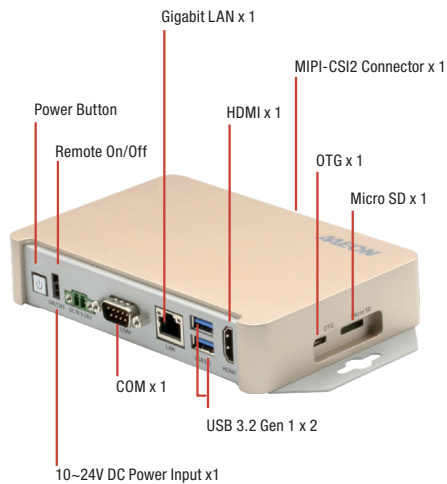

Rear View

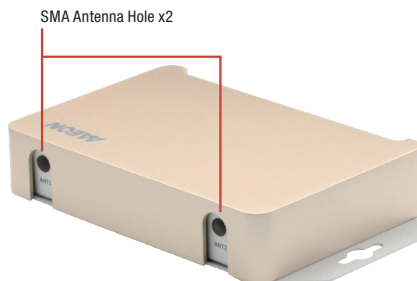

Bottom View

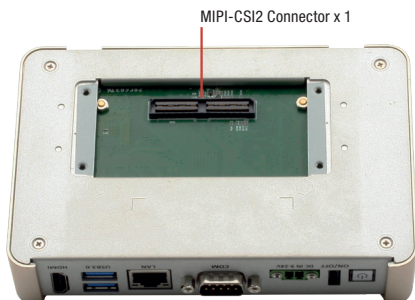

## Features

- Nvidia TX2 Module
- HMP Dual Denver 2 + Quad ARM A57
- 8GB LPDDR4
- 32GB eMMC 5.1
- HDMI 2.0
- USB 3.2 Gen 1 x 2
- GbE LAN x 1
- RS-232 x1
- MIPI-CSI2 connector x1
- Compact Size chassis



## Specifications

System	
CPU	HMP Dual Denver 2 + Quad ARM A57
Chipset	N/A
System Memory	8GB LPDDR4
AI Solution	Nvidia Jetson TX2
Display Interface	HDMI 2.0 x 1
Storage Device	32GB eMMC 5.1 MicroSD
Ethernet	10/100/1000 Base-TX x 1
I/O	USB Type A x 2 for USB 3.2 Gen 1 RJ-45 x 1 for GbE LAN Ethernet DB-9 x 1 for RS-232 Remote on/off switch x 1 Antenna Holes x 2 MicroSD x 1 OTG x 1
Expansion	SATA x1 (optional) USB 2 x 3 (optional) MIPI-CSI2 board to board connector x 1 (The connector used on the carrier board is a Samtec QSH-060-01-H-D-A. The mating connector is a Samtec QTH-060-01-H-D-A.)
Indicator	Power LED
OS Support	AAEON ACLinux 4.9, Compliance with Ubuntu 18.04
Power Supply	
Power Requirement	10~24V with 2-pin terminal block
Mechanical	
Mounting	Wallmount
Dimensions (W x H x D)	6.02" x 1.18" x 3.98" (153mm x 30mm x 101mm)
Gross Weight	4.40 lb (2 Kg)
Net Weight	2.20 lb (1 Kg)
Environmental	
Operating Temperature	-4°F ~ 122°F(-20°C ~ 50°C, with 0.5 m/s AirFlow)
Storage Temperature	-13°F ~176 °F (-25°C ~ 80°C)
Storage Humidity	95% @ 40°C, non-condensing
Anti-Vibration	Random, 5 Grm, 5~500Hz
Certification	CE/FCC class A

### Dimension

Unit: mm

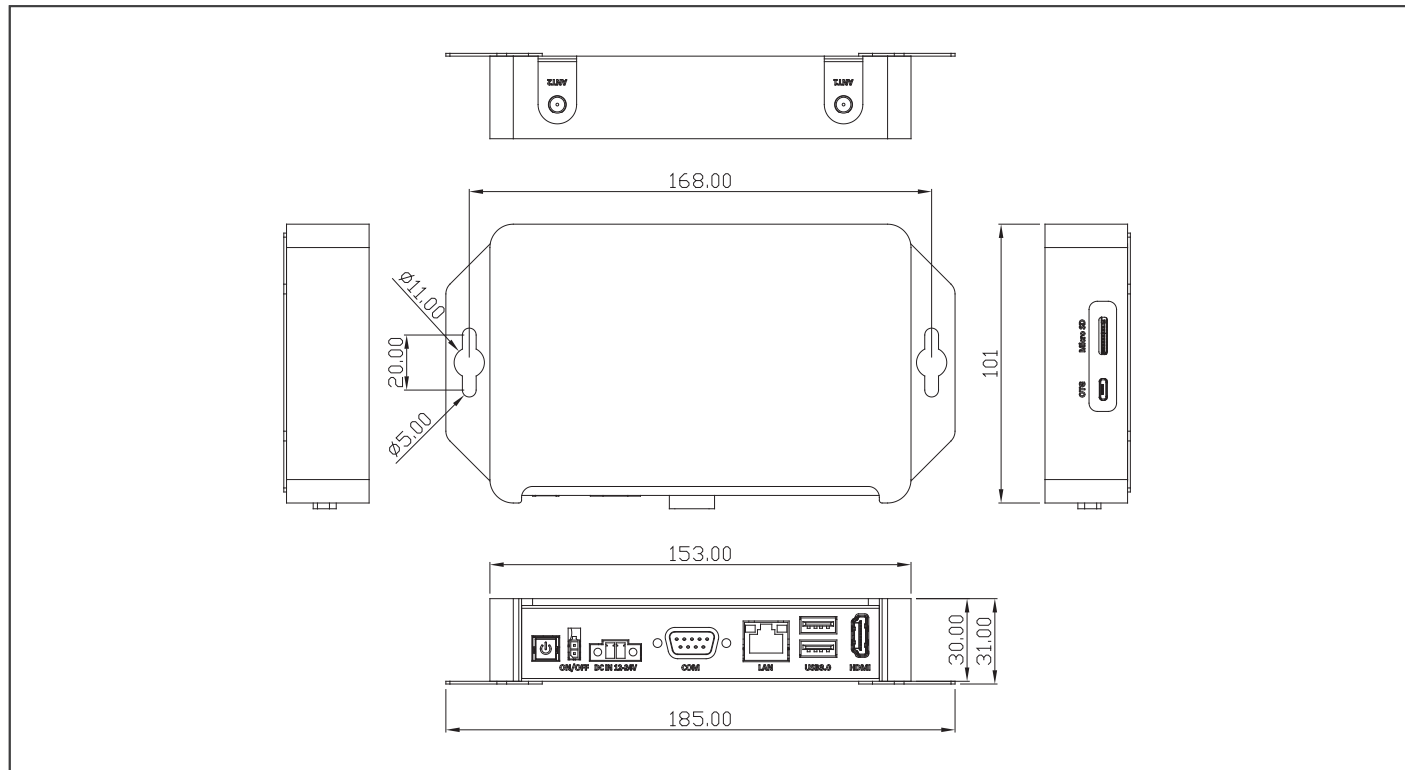

### Ordering Information

Part Number	CPU	PCH	RAM	LAN	USB 3.2 Gen 1	USB 2.0	RS-232	RS-232/422/485	Digital I/O	Audio	Storage	Display	Expansion	Mounting	Power	Operation temp.
BOXER-8130AI-A1-1010	HMP Dual Denver 2 + Quad ARM A57	—	8	1	2	—	1	—	—	—	32G eMMC	HDMI x 1	MicroSD x1 SATA x1 (option) USB 2 x 3 (option) MIPI-CSI2 board to board connector x1	Wallmount	10V – 24V	-20°C – 50°C

### Packing List

- Wallmount Bracket x 1
- Power Connector x 1
- BOXER-8130AI

### Optional Accessories

- 1255300611  
Power Adapter
- 1702031802  
Power Cord (US Type)
- 1702031803  
Power Cord (Europe)
- 170203180E  
Power Cord (Japan)

AI@Edge Fanless Embedded Box PC with NVIDIA Jetson TX2, 8 USB 3.2 Gen 1

Front View

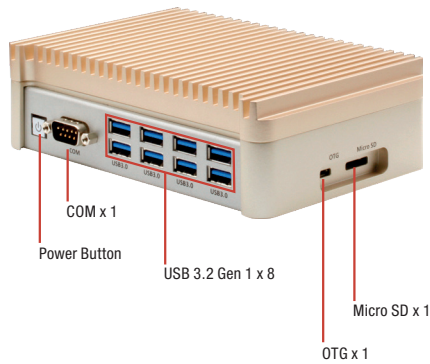

Rear View

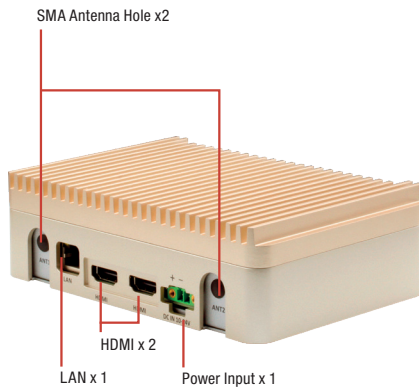

## Features

- Nvidia TX2 Module
- HMP Dual Denver 2 + Quad ARM A57
- 8GB LPDDR4
- 32GB eMMC 5.1
- HDMI 2.0
- USB 3.2 Gen 1 x 8
- GbE LAN x 1, COM x 1
- Compact Size chassis



## Specifications

System	
CPU	HMP Dual Denver 2 + Quad ARM® A57
Chipset	N/A
System Memory	8GB LPDDR4
AI Solution	Nvidia Jetson TX2
Display Interface	HDMI 2.0 x 2
Storage Device	32GB eMMC 5.1 MicroSD
Ethernet	10/100/1000 Base-TX x 1
I/O	USB Type A x 8 for USB 3.2 Gen 1 DB-9 x1 for RS-232 HDMI 2.0 x 2 Power Switch 2-pin 10~24V DC-in Connector RJ-45 x1 for GbE LAN Ethernet Antenna Holes x 2 MicroSD x 1 OTG x 1
Expansion	SATA x1 (optional) DB-9 RS-232 x1 (optional) 2 channel CANBUS x1 (optional)
Indicator	Power LED
OS Support	AAEON ACLinux 4.9, Compliance with Ubuntu 18.04
Power Supply	
Power Requirement	10~24V with 2-pin terminal block
Mechanical	
Mounting	Wallmount
Dimensions (W x H x D)	6.02" x 1.77" x 3.98" (153mm x 45mm x 101mm)
Gross Weight	4.40 lb (2 Kg)
Net Weight	2.2 lb (1 Kg)
Environmental	
Operating Temperature	-4°F ~122°F (-20°C ~ 50°C, according to IEC60068-2 with 0.5 m/s AirFlow; with Industrial Device)
Storage Temperature	-13°F ~176 °F (-25°C ~ 80°C)
Storage Humidity	95% @ 40°C, non-condensing
Anti-Vibration	Random, 3 Grms, 5~500Hz
Certification	CE/FCC class A

### Dimension

Unit: mm

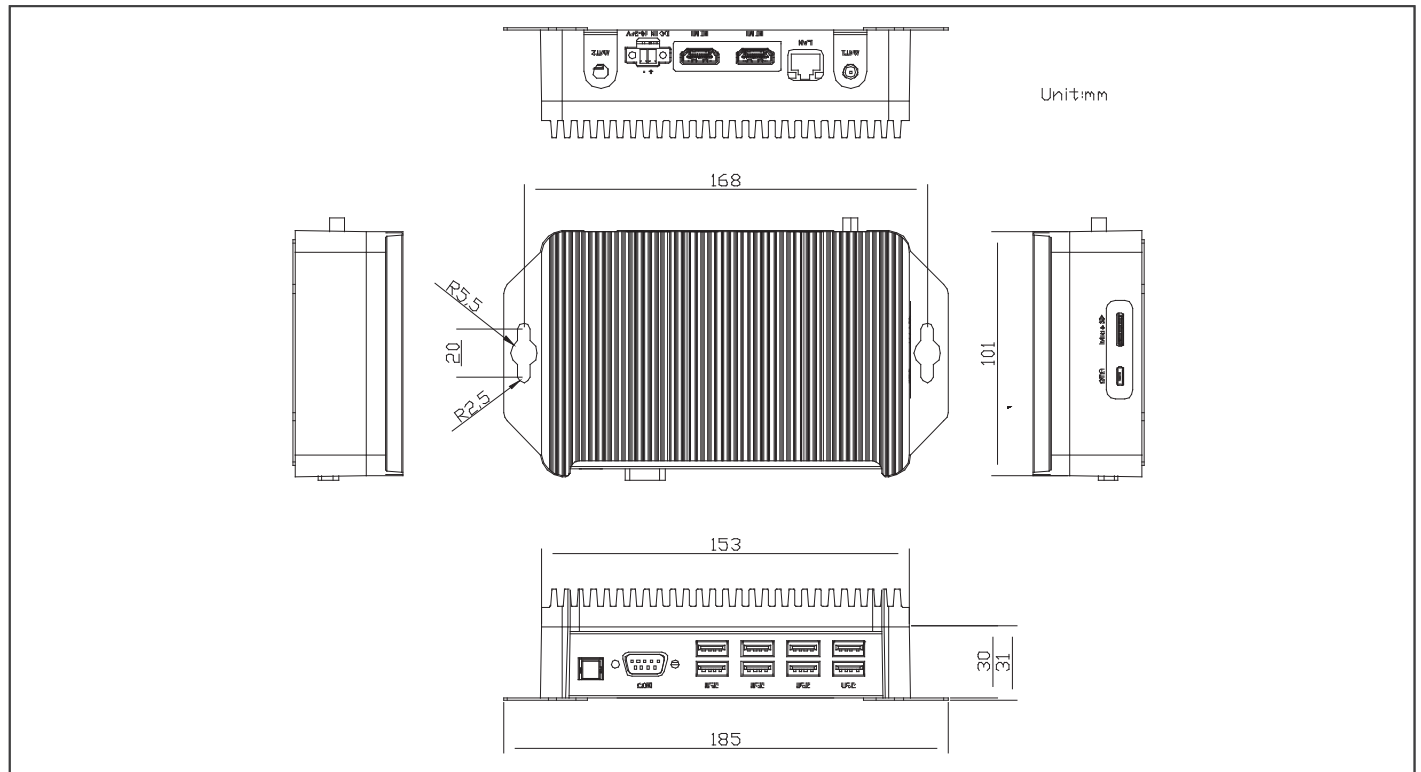

### Ordering Information

Part Number	CPU	PCH	RAM	LAN	USB 3.2 Gen 1	USB 2.0	RS-232	RS-232 /422/485	Digital I/O	Audio	Storage	Display	Expansion	Mounting	Power	Operation temp.
BOXER-8150AI-A1-1010	HMP Dual Denver 2 + Quad ARM A57	—	8	1	8	—	1	—	—	—	32GB eMMC	HDMI x2	MicroSD x1 SATA x1 (option) DB-9 RS-232 x1 (option) 2 channel CANBUS x1 (option)	Wallmount	10V ~ 24V	-20°C ~ 50°C

### Packing List

- Wallmount Bracket x 1
- Power Connector x 1
- BOXER-8150AI

### Optional Accessories

- **1255300611**  
Power Adapter
- **1702031802**  
Power Cord (US Type)
- **1702031803**  
Power Cord (Europe)
- **170203180E**  
Power Cord (Japan)



# BOXER-8170AI

AI@Edge Fanless Embedded Box PC with NVIDIA Jetson TX2, 4 PoE LAN

Front View

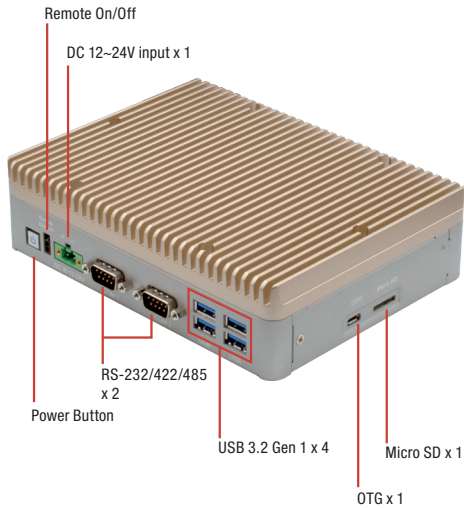

Rear View

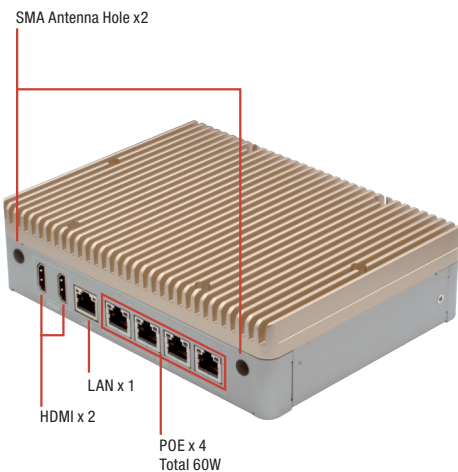

## Features

- Designed for Embedded AI vehicle Controller
- Gigabit Ethernet x 1 and 802.3af PoE x 4 for surveillance
- Nvidia TX2 Module
- HMP Dual Denver 2 + Quad ARM A57
- 8GB LPDDR4
- 32GB eMMC 5.1
- HDMI 2.0 x 2
- USB 3.2 Gen 1 x 4
- COM x 2
- DC 12 ~ 24V



## Specifications

System	
CPU	HMP Dual Denver 2 + Quad ARM A57
Chipset	N/A
System Memory	8GB LPDDR4
AI Solution	Nvidia Jetson TX2
Display Interface	HDMI 2.0
Storage Device	32GB eMMC 5.1 Micro-SD
Ethernet	10/100/1000 Base-TX x 1 IEEE 802.3 af PoE LAN x 4
I/O	RJ-45 x 1 for GbE LAN IEEE 802.3af PoE x 4 (60W total power budget) HDMI Type A x 2 for HDMI 2.0 USB Type A x 4 for USB 3.2 Gen 1 DB-9 RS-232/422/485 x 2 Power On/Off Button x 1 DC-In 2-pin terminal block x 1 USB OTG x 1 12~24V DC-in Power Input x 1 SMA Antenna Holes x 2
Expansion	SATA x 1 (optional) USB 2 x 1 (optional) 2 Channel CANBUS x 1 (optional)
Indicator	Power LED
OS Support	AAEON AALinux 4.9, Compliance with Ubuntu 18.04
Power Supply	
Power Requirement	12 ~ 24V with 2-pin terminal block
Mechanical	
Mounting	Wallmount
Dimensions (W x H x D)	7.09" x 1.89" x 5.35" (180 mm x 48 mm x 136 mm)
Gross Weight	6.39 lb (2.9 Kg)
Net Weight	4.73 lb (2.15 Kg)
Environmental	
Operating Temperature	-20°C ~ 50°C (according to IEC68-2-14 with 0.5 m/s AirFlow ; with industrial devices)
Storage Temperature	-40°F ~176 °F (-40°C ~ 80°C)
Storage Humidity	5~95% @ 40°C, non-condensing
Anti-Vibration	3 Grms/ 5 ~ 500Hz/ operation
Certification	CE/FCC class A

## Dimension

Unit: mm

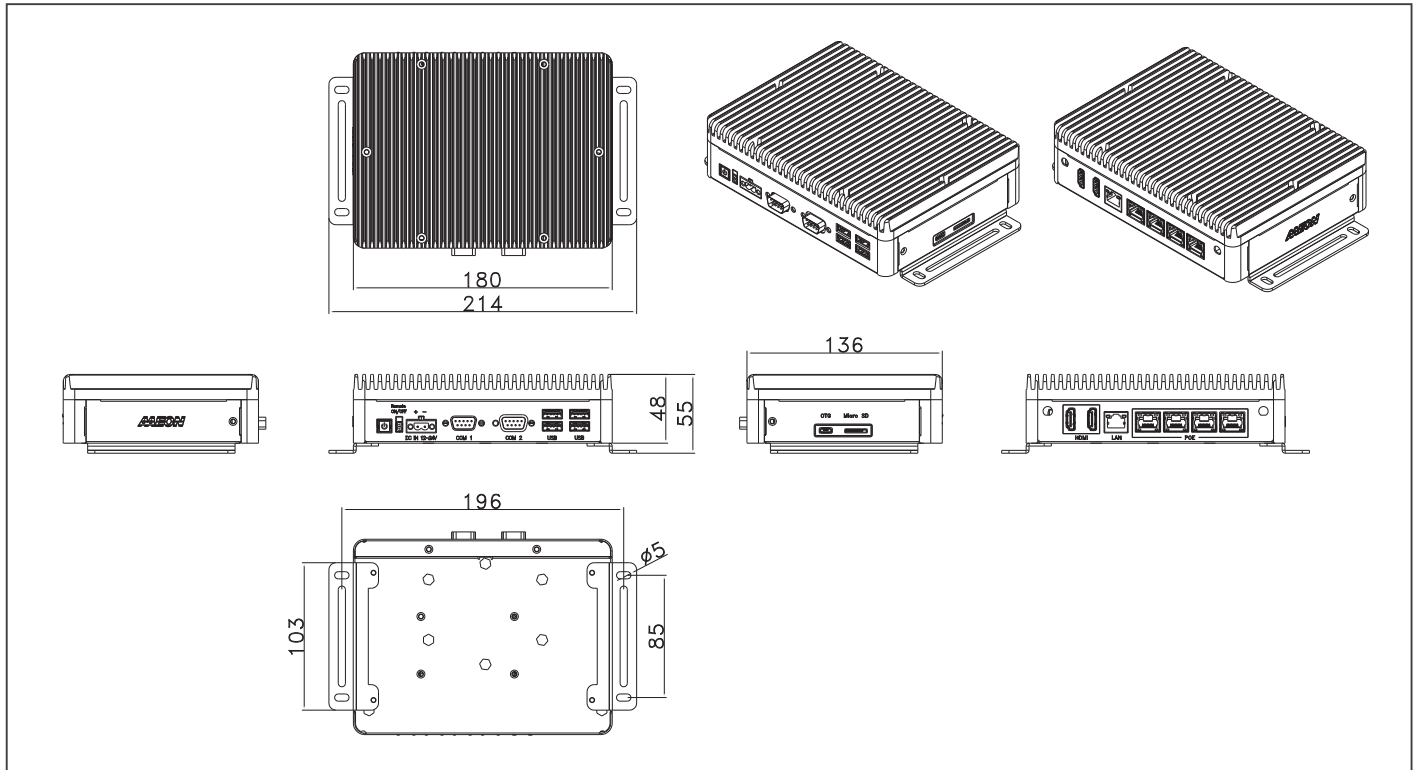

## Ordering Information

Part Number	RAM	LAN	PCH	PDE	USB 3.2 Gen 1	USB 2.0	RS-232	RS-232/422/485	Digital I/O	Audio	Storage	Display	Expansion	Mounting	Power	Operation temp.
BOXER-8170AI-A1-1010	8GB LPDDR4	1	—	4	4	0	—	2	—	—	32GB eMMC	HDMI x 2	MicroSD x1 SATA x1 (option) USB 2 x1 (option) 2 Channel CANBUS x1 (option)	Wallmount	24V DC-in (12V testing)	-20°C ~ 50°C

## Packing List

- Wallmount Bracket x 2
- Power Connector x 1
- Screw Pack x 1
- BOXER-8170AI

## Optional Accessories

- 1255900849  
Power Adapter
- 1702031802  
Power Cord (US Type)
- 1702031803  
Power Cord (Europe)
- 170203180E  
Power Cord (Japan)

AI@Edge Fanless Embedded Box PC with NVIDIA Jetson Nano, 5 GbE LAN Ports

Front View

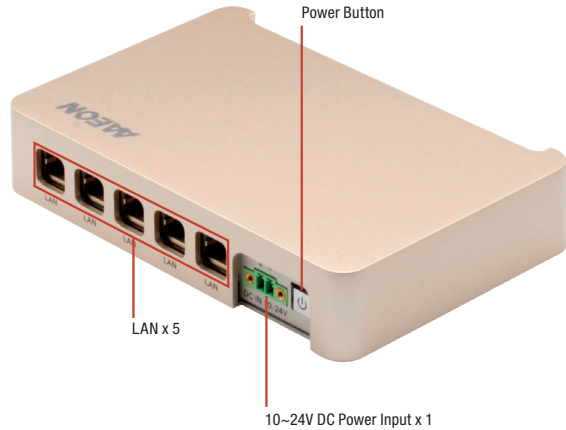

Rear View

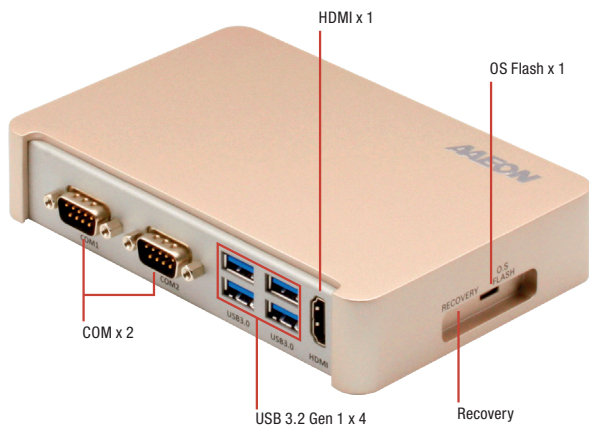

## Features

- NVIDIA Jetson nano
- Quad Core ARM A57 Processor
- 4GB LPDDR4 + 16GB Micro-SD or eMMC
- LAN x 5
- USB 3.2 Gen 1 x 4
- 10-24Vdc Power input



## Specifications

System	
CPU	Quad Core ARM® Cortex®-A57 MPCore Processor
Chipset	—
System Memory	4GB LPDDR4
AI Solution	Nvidia Jetson Nano
Display Interface	HDMI 2.0
Storage Device	16GB Micro-SD or eMMC
Ethernet	10/100/1000Base-TX x 5
I/O	USB 3.2 Gen 1 x 4 LAN x 5 RS-232 x 2 HDMI x 1 Micro-USB for Flash OS x 1 DC Power Input x 1 Power Button x 1 Recovery Button x 1
Expansion	—
Indicator	Power LED x 1
OS Support	ACLinux 4.9 or above (Compatible with Ubuntu 18.04)
Power Supply	
Power Requirement	10 ~ 24V DC with 2-pin terminal block
Mechanical	
Mounting	Wallmount
Dimensions (W x D x H)	6.06" x 3.98" x 1.18" (154 mm x 101 mm x 30 mm)
Gross Weight	4.40 lbs (2 Kg)
Net Weight	2.20 lbs (1 Kg)
Environmental	
Operating Temperature	-4°F ~ 140°F (-20°C ~ 60°C, according to IEC60068-2 with 0.5 m/s AirFlow)
Storage Temperature	-49°F ~ 176°F (-45°C ~ 80°C)
Storage Humidity	95% @ 40°C, non-condensing
Anti-Vibration	3 Grms/ 5 ~ 500Hz/ operation – MicroSD or eMMC
Certification	CE/FCC class A

## Dimension

Unit: mm

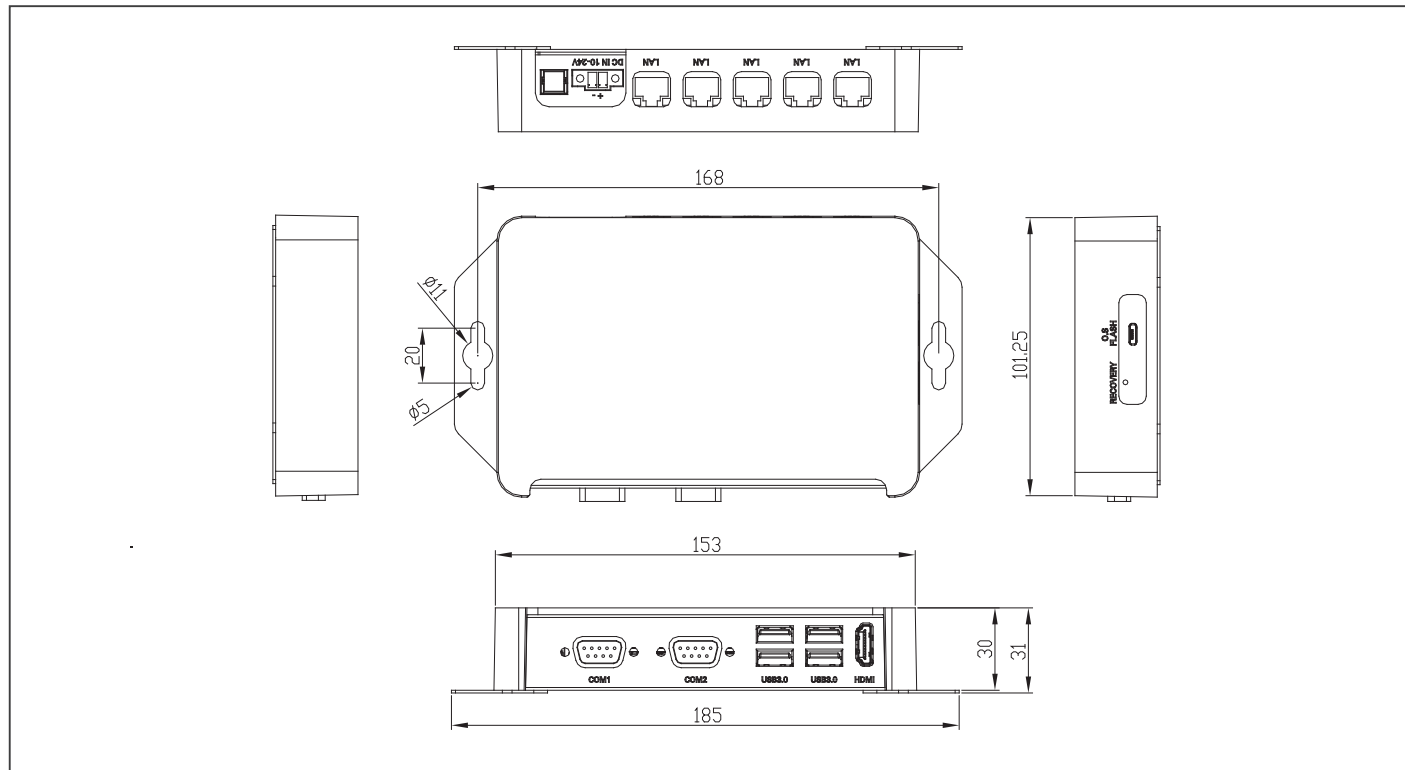

## Ordering Information

Part Number	AI solution	LAN	USB 3.2 Gen 1	RS-232	Storage	Display	Mounting	Power	Operation temp.
BOXER-8220AI-A1-1010	Jetson Nano	5	4	2	16GB MicroSD x 1	HDMI x 1	Wallmount	10~24V	-20°C ~ 60°C

## Packing List

- Wallmount Bracket x 2
- Power Connector x 1
- BOXER-8220AI

## Optional Accessories

- 1255300611  
60W Power Adapter
- 1702031802  
Power Cord (US type)
- 1702031803  
Power Cord (European Type)
- 170203180E  
Power Cord (Japanese Type)

Front View

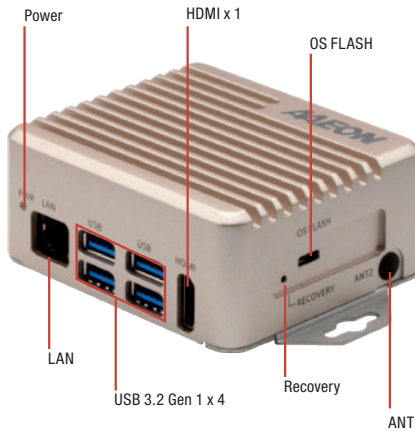

Rear View

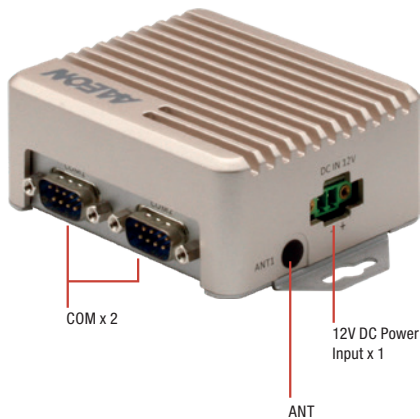

## Features

- NVIDIA Jetson nano
- Quad core ARM A57 Processor
- 4GB LPDDR4 + 16GB Micro-SD or eMMC
- LAN x 1 + RS-232 x 2
- 12Vdc Power input



## Specifications

System	
CPU	Quad Core ARM® Cortex®-A57 MPCore Processor
Chipset	—
System Memory	4GB LPDDR4
AI Solution	Nvidia Jetson Nano
Display Interface	HDMI 2.0
Storage Device	16GB Micro-SD or eMMC
Ethernet	10/100/1000Base-TX x 1
I/O	USB 3.2 Gen 1 x 4 LAN x 1 RS-232 x 2 HDMI x 1 MicroSD x 1 DC Power Input x 1 Recovery Button x 1 Micro-USB for Flash OS x 1
Expansion	M.2 E-Key 2230 x 1(for WiFi)
Indicator	Power LED x 1
OS Support	Linux (AAEON ACLinux 4.9, Compliance with Ubuntu 18.04)
Power Supply	
Power Requirement	12Vdc w/ 2-pin terminal block
Mechanical	
Mounting	Wallmount
Dimensions (W x D x H)	3.39" x 2.87" x 1.3" (88mm x 75mm x 39mm)
Gross Weight	2.20 lb (1 Kg)
Net Weight	0.88 lb (0.4 Kg)
Environmental	
Operating Temperature	-4°F ~ 122°F (-20°C ~ 50°C, according to IEC60068-2 with 0.5 m/s AirFlow)
Storage Temperature	-49°F ~176°F (-45°C ~ 80°C)
Storage Humidity	95% @ 40°C, non-condensing
Anti-Vibration	3 Grms/ 5 ~ 500Hz/ operation – MicroSD or eMMC
Certification	CE/FCC class A

## Dimension

Unit: mm

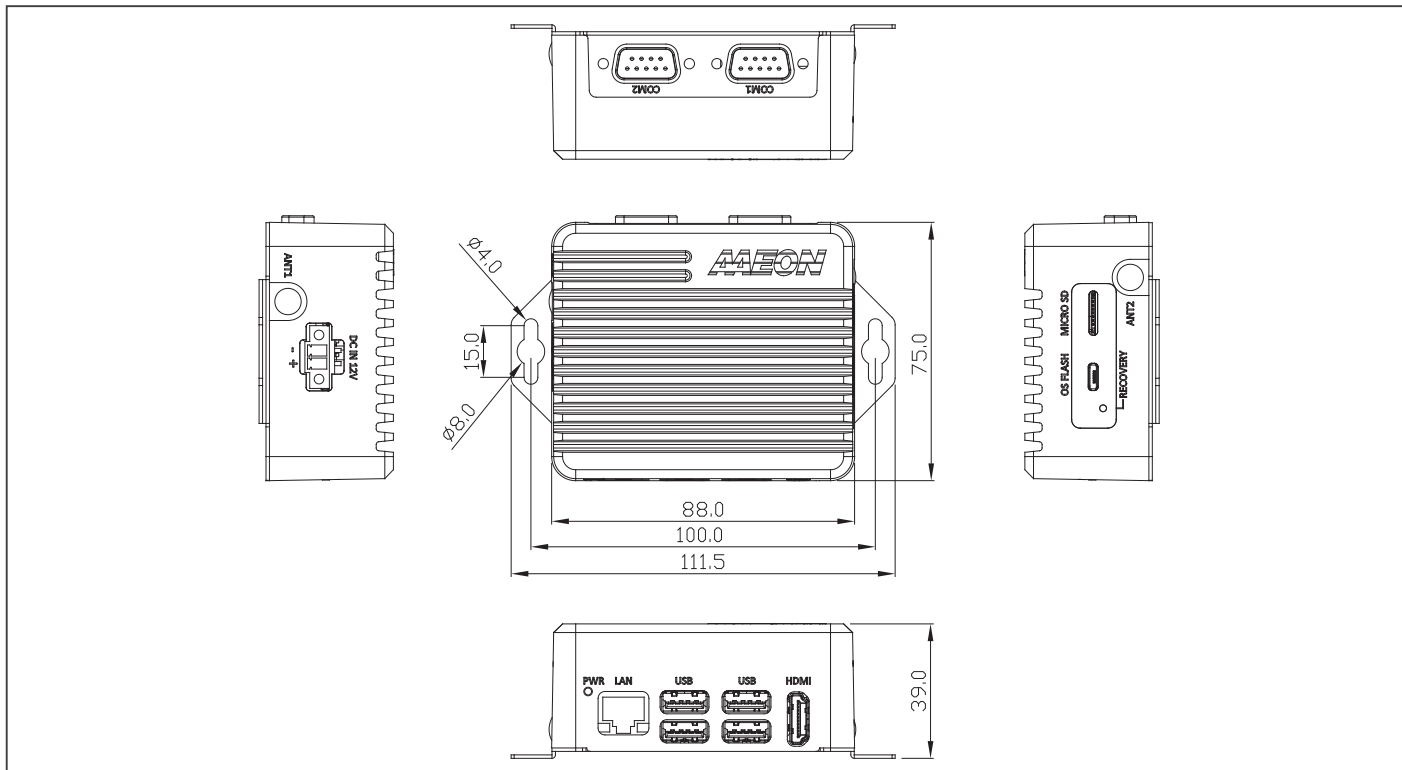

## Ordering Information

Part Number	AI solution	LAN	USB 3.2 Gen 1	RS-232	Storage	Display	Mounting	Power	Operation temp.
BOXER-8221AI-A1-1110	Jetson Nano	1	4	2	16GB MicroSD x 1	HDMI x 1	Wallmount	12Vdc w/ 2 pin terminal block	-20°C ~ 50°C

## Packing List

- Wallmount Bracket x 2
- Power Connector x 1
- BOXER-8221AI

## Optional Accessories

- 1255300611  
60W Power Adapter
- 1702031802  
Power Cord (US type)
- 1702031803  
Power Cord (European Type)
- 170203180E  
Power Cord (Japanese Type)